

REV.	DESCRIPTION	DATE
A	NEW DRAWING	2/1/2007

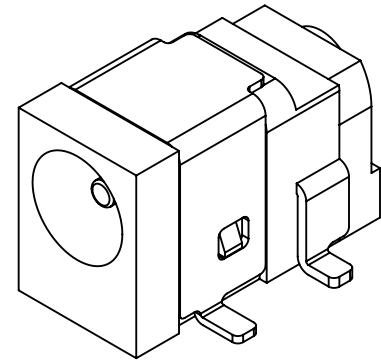

TOLERANCE:
 X.X ±0.2mm
 X.XX ±0.1mm
 X.XXX ±0.05mm

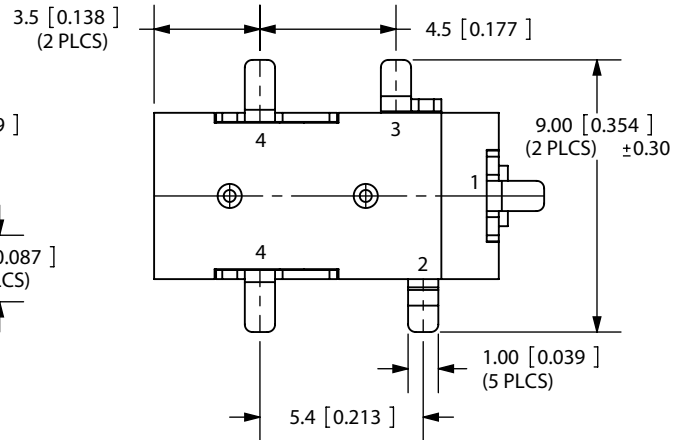
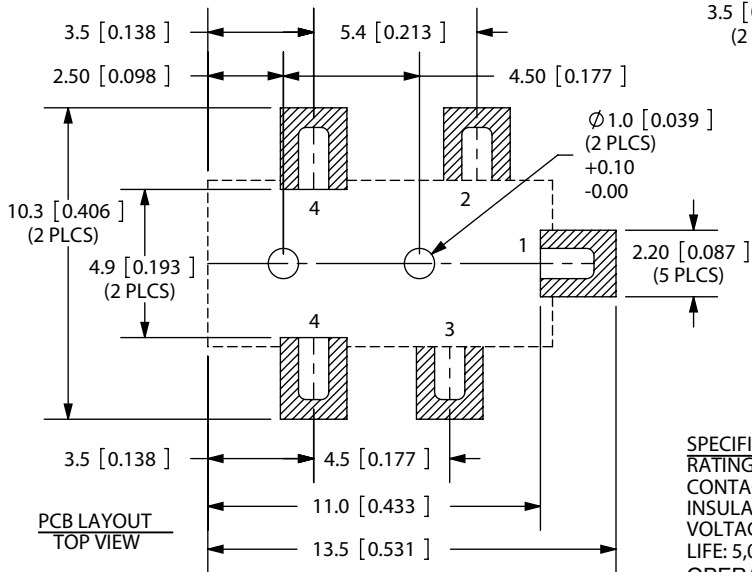
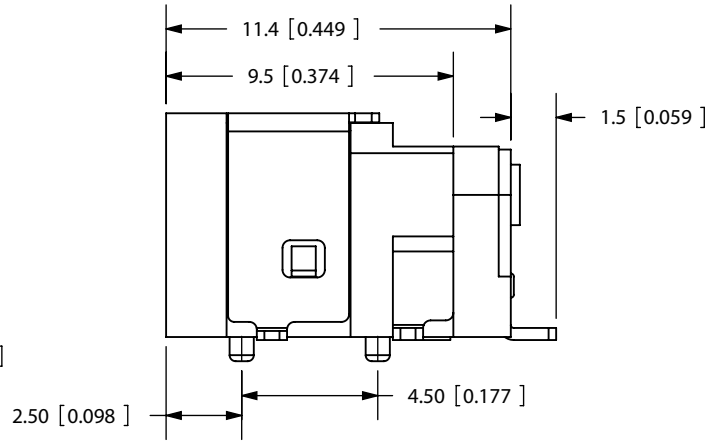
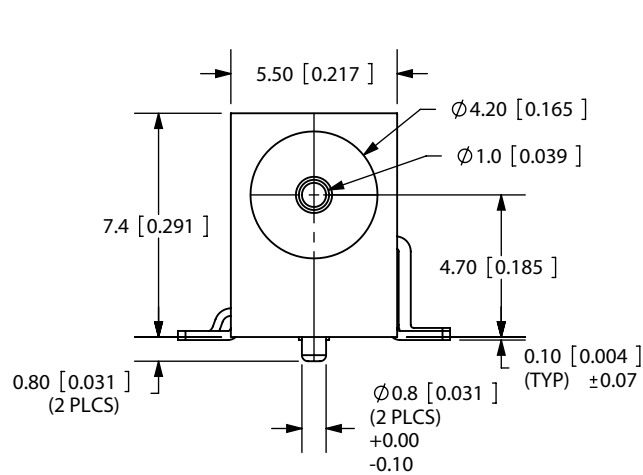

SPECIFICATIONS:
 RATING: 16V DC @ 2A
 CONTACT RESISTANCE: 50m OHMS MAX
 INSULATION RESISTANCE: 100M OHMS MIN: 500V DC
 VOLTAGE WITHSTAND: 500V AC R.M.S. FOR 1 MINUTE
 LIFE: 5,000 CYCLES
 OPERATING TEMP: -25° ~ +85°C

	MATERIAL	PLATING
TERMINAL 1	Brass	Silver
TERMINAL 2	Copper Alloy	Silver
TERMINAL 3	Brass	Silver
CENTER PIN	Copper	Nickel
SHIELD 4	Cold Rolled Steel	Tin
HOUSING	PA6T	
COVER	PA6T	



2050 SW 112th Ave.
 Tualatin, OR 97062
 Phone: 503-612-2300
 800-275-4899
 Fax: 503-612-2383
 Website: www.cui.com

MODEL NO.	PJ-030C-SMT
SCHMATIC	

CENTER PIN DIAMETER 1.0mm Dia.

PC FILE NAME:
 PJ-030C-SMT

COPYRIGHT 2007 BY CUI INC.

TITLE:	1.0mm SURFACE MOUNT POWER JACK	REV:	A
PART NO.	PJ-030C-SMT	UNITS:	MM [INCHES]
DRAWN BY:	ZRJ	APPROVED BY:	
		SCALE:	4:1