





| | | | | | |
|-----------------------|--------|------------------|----------|--------------|--------|
| Messrs. | | | | | |
| Product Specification | Model: | MTF-TQ35SP741-AV | Rev. No. | Issued Date. | Page. |
| | | | C | Jan.16, 08 | 1 / 31 |

LIQUID CRYSTAL DISPLAY MODULE
MODEL: MTF-TQ35SP741-AV
Customer's No.:

| |
|------------|
| Acceptance |
| |

Microtips Technology Inc.
12F. No.31 Lane 169, Kang Ning St.,
His-Chih, Taipei Hsien, Taiwan
FAX: 886-2-26958625

| |
|-------------------------|
| Approved and Checked by |
| |

| Approved by | Checked by | | Made by |
|---|---|--|---|
|  |  |  |  |



Microtips Technology Inc.

| | | | | | |
|-----------------------|--------|------------------|----------|--------------|--------|
| Messrs. | | | | | |
| Product Specification | Model: | MTF-TQ35SP741-AV | Rev. No. | Issued Date. | Page. |
| | | | C | Jan.16, 08 | 3 / 31 |

Contents

| | |
|---|----|
| 1. GENERAL DESCRIPTION AND FEATURES | 5 |
| 1.1 Features..... | 5 |
| 1.2 General Specifications..... | 5 |
| 2. BLOCK DIAGRAM | 6 |
| 2.1 TFT-LCD Module (Interface System Structure) with Back Light Unit..... | 6 |
| 2.2 LCM Driver IC Block..... | 7 |
| 3. INPUT TERMINAL PIN ASSIGNMENT | 8 |
| 3.1 CN1 Pin Assignment (LCD)..... | 8 |
| 3.2 Touch Panel Pin Assignment..... | 10 |
| 4. OPTICAL CHARACTERISTICS | 10 |
| 5. ABSOLUTE MAXIMUM RATINGS | 13 |
| 5.1 Absolute Ratings of Environment..... | 13 |
| 5.2 Maximum Ratings (Voltage Referenced to VSS)..... | 13 |
| 6. ELECTRICAL CHARACTERISTICS | 14 |
| 6.1 DC Electrical Characteristics | 14 |
| 7. AC CHARACTERISTICS | 15 |
| 7.1 Pixel timing..... | 15 |
| 7.2 Data transaction timing in parallel RGB (24 bit) interface (SYNC mode)..... | 16 |
| 7.3 Signal timing in DE mode | 17 |
| 8. BACKLIGHT SPECIFICATIONS | 18 |
| 8.1 Absolute Maximum Ratings | 18 |
| 8.2 Electrical/Operating Characteristics | 18 |
| 8.3 Electrical Circuit of Backlight..... | 18 |
| 9. BASIC DISPLAY COLOR AND GRAY SCALE | 19 |
| 10. QUALITY STANDARD FOR LCD | 20 |
| 10.1 Objective..... | 20 |
| 10.2 Scope..... | 20 |
| 10.3 Inspection specification..... | 22 |
| 11. RELIABILITY CONDITION FOR LCD | 25 |
| 11.1 LCM Reliability Test..... | 25 |
| 11.2 Touch panel Reliability | 26 |
| 12. PRECAUTIONS | 27 |
| 12.1 Operation | 27 |
| 12.2 Safety | 27 |
| 12.3 Handling | 27 |
| 12.4 Static electricity | 29 |



| | | | | | |
|-----------------------|--------|------------------|----------|--------------|--------|
| Messrs. | | | | | |
| Product Specification | Model: | MTF-TQ35SP741-AV | Rev. No. | Issued Date. | Page. |
| | | | C | Jan.16, 08 | 4 / 31 |

| | |
|--------------------------------------|-----------|
| 12.5 Storage | 29 |
| 12.6 Cleaning | 29 |
| 12.7 Waste..... | 29 |
| 13. WARRANTY | 30 |
| 14. DIMENSIONAL OUTLINES..... | 30 |



| | | | | | |
|-----------------------|--------|------------------|----------|--------------|--------|
| Messrs. | | | | | |
| Product Specification | Model: | MTF-TQ35SP741-AV | Rev. No. | Issued Date. | Page. |
| | | | C | Jan.16, 08 | 5 / 31 |

1. GENERAL DESCRIPTION AND FEATURES

MTF-TQ35SP741-AV is a TM (Transmissive) type color active matrix TFT (Thin Film Transistor) liquid crystal display (LCD) that uses amorphous silicon TFT devices. This model is composed of a TFT-LCD Panel, driver IC, FPC , Touch panel and a back-light unit. The resolution of a 3.5" contains 320RGBx240 dots and can display up to 16.7M colors. The following table described the features of MTF-TQ35SP741-AV.

1.1 Features

- Support 24-bit data (RGB).

1.2 General Specifications

| Item | Specification | Unit | Note |
|--------------------|---|------|------|
| Screen Size | 3.5" diagonal | inch | - |
| Display Resolution | 320 x RGB x 240 | Dot | - |
| Dot Pitch | 0.073 (W) x 0.219 (H) | mm | - |
| Active Area | 70.08 (W) x 52.56 (H) | mm | - |
| Outline Dimension | 77.8 (W) x 64.5 (H) x 4.12 (T), Not including FPCB | mm | - |
| Display Mode | Normally white/Transmissive | - | - |
| Pixel Arrangement | RGB-Strip | - | - |
| Surface Treatment | Anti-glare (AG) | - | - |
| weight | 128 | g | - |
| Viewing Direction | 6 o'clock | - | - |
| Input Interface | Digital 24-bits parallel RGB | - | - |
| Driver IC | Himax HX8238A | - | - |

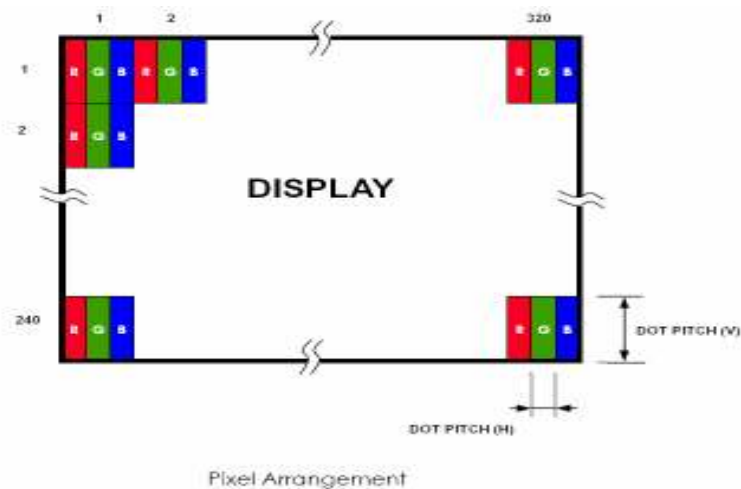

Microtips Technology Inc.

| | | | | | |
|-----------------------|--------|------------------|----------|--------------|--------|
| Messrs. | | | | | |
| Product Specification | Model: | MTF-TQ35SP741-AV | Rev. No. | Issued Date. | Page. |
| | | | C | Jan.16, 08 | 6 / 31 |

2. BLOCK DIAGRAM

2.1 TFT-LCD Module (Interface System Structure) with Back Light Unit

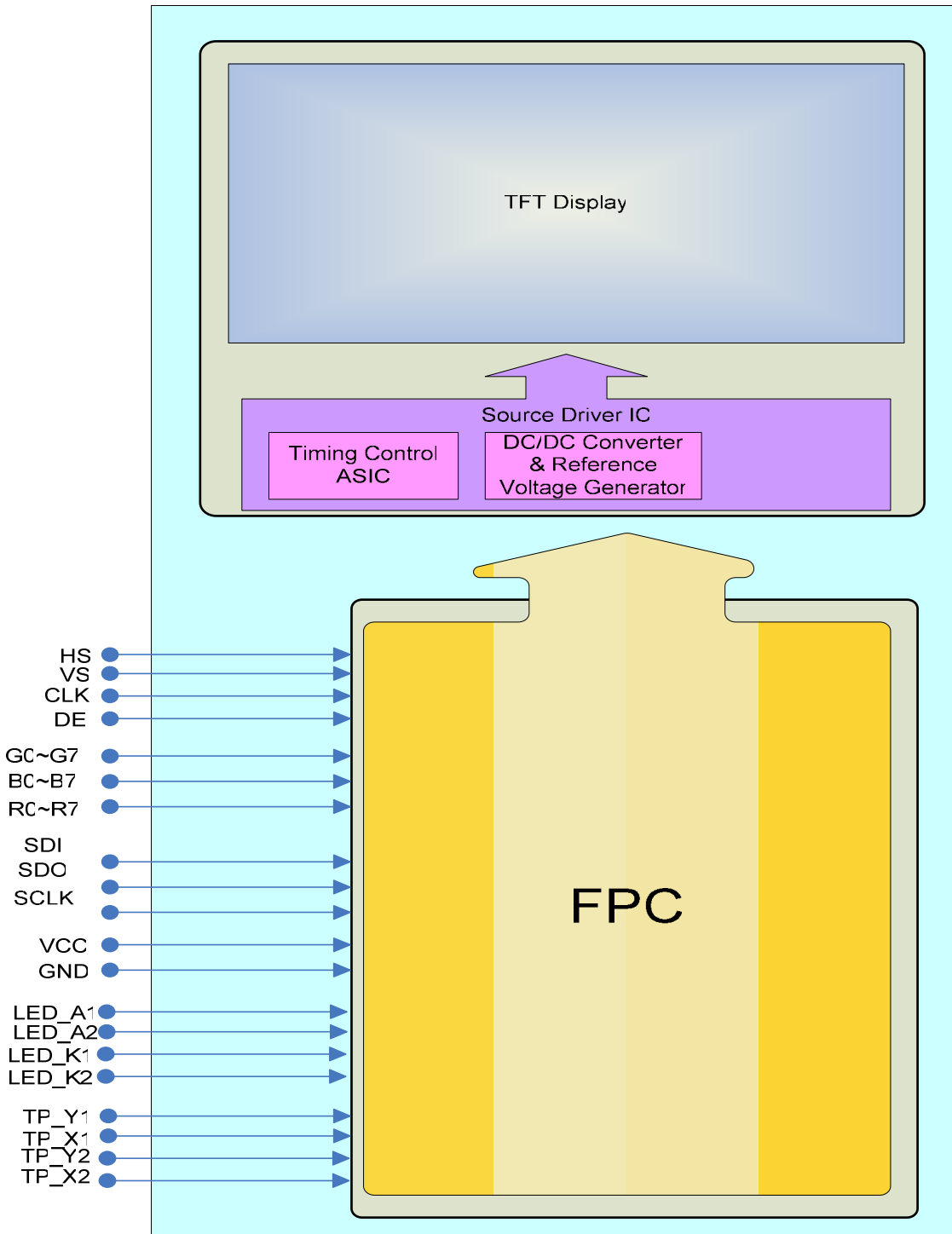

Messrs.

| Product Specification | Model: | MTF-TQ35SP741-AV | Rev. No. | Issued Date. | Page. |
|-----------------------|--------|------------------|----------|--------------|--------|
| | | | C | Jan.16, 08 | 7 / 31 |

2.2 LCM Driver IC Block

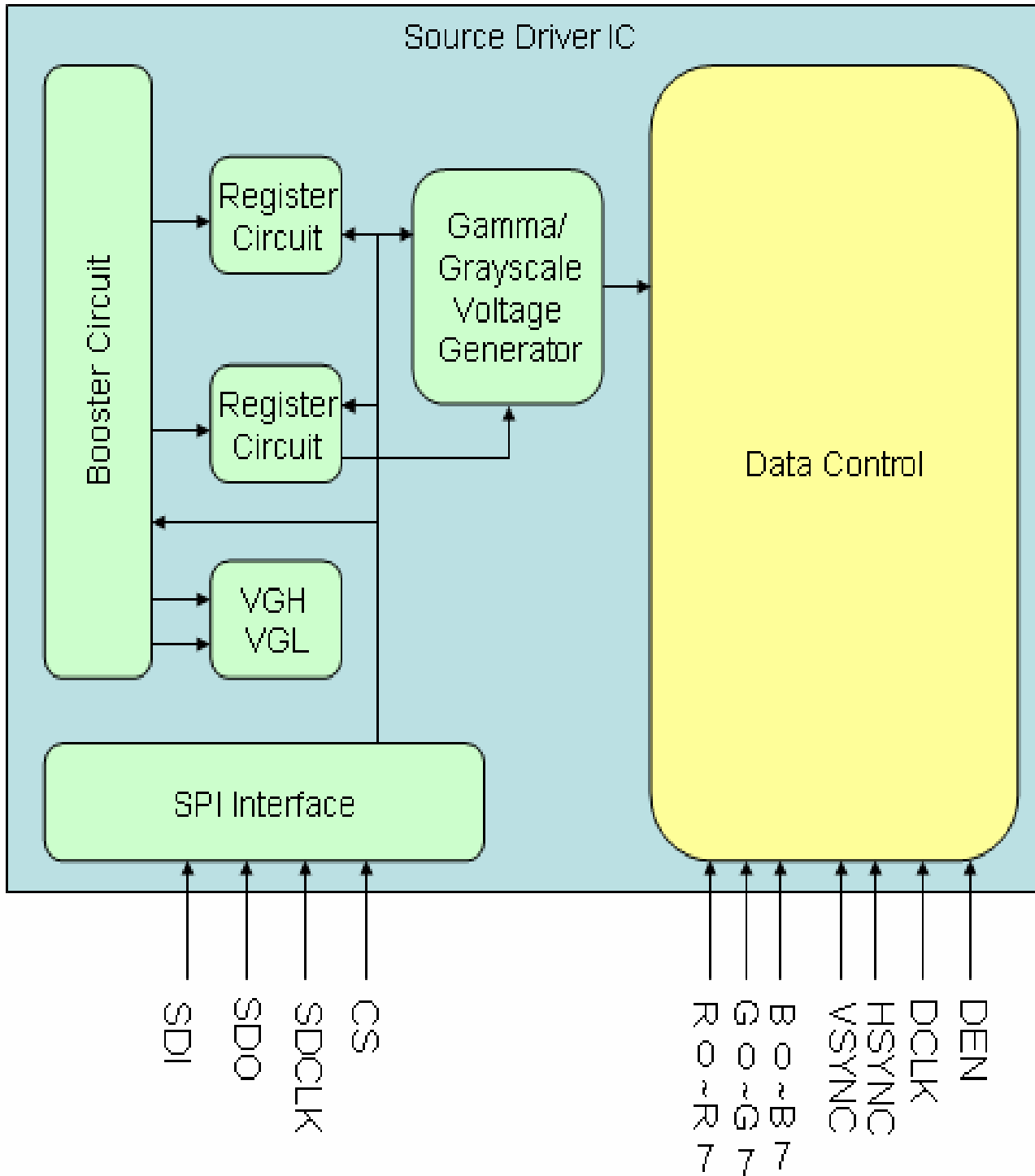

| | | | | | |
|-----------------------|--------|------------------|----------|--------------|--------|
| Messrs. | | | | | |
| Product Specification | Model: | MTF-TQ35SP741-AV | Rev. No. | Issued Date. | Page. |
| | | | C | Jan.16, 08 | 8 / 31 |

3. INPUT TERMINAL PIN ASSIGNMENT

3.1 CN1 Pin Assignment (LCD)

| Pin No. | Symbol | I/O | Function | Remark |
|---------|--------------------|-----|--|--------|
| 1 | LED K1 | I | Backlight LED Ground | |
| 2 | LED K2 | I | Backlight LED Ground | |
| 3 | LED A1 | I | Backlight LED Power (10.2V/20mA) | |
| 4 | LED A2 | I | Backlight LED Power (10.2V/20mA) | |
| 5 | N/C | - | Not Connection | |
| 6 | /REST | I | Hardware Reset | |
| 7 | N/C | - | Not Connection | |
| 8 | N/C or Y1 (Top) | I | No connection (for MTF-TQ35SN741-AV) or Y1 (Top) (for MTF-TQ35SP741-AV) | |
| 9 | N/C or X1 (Right) | I | No connection (for MTF-TQ35SN741-AV) or X1 (Right) (for MTF-TQ35SP741-AV) | |
| 10 | N/C or Y2 (Bottom) | I | No connection (for MTF-TQ35SN741-AV) or Y2 (Bottom) (for MTF-TQ35SP741-AV) | |
| 11 | N/C or X2 (Left) | I | No connection (for MTF-TQ35SN741-AV) or X2 (Left) (for MTF-TQ35SP741-AV) | |
| 12 | B0 | I | Blue Data Bit 0 | |
| 13 | B1 | I | Blue Data Bit 1 | |
| 14 | B2 | I | Blue Data Bit 2 | |
| 15 | B3 | I | Blue Data Bit 3 | |
| 16 | B4 | I | Blue Data Bit 4 | |
| 17 | B5 | I | Blue Data Bit 5 | |
| 18 | B6 | I | Blue Data Bit 6 | |
| 19 | B7 | I | Blue Data Bit 7 | |
| 20 | G0 | I | Green Data Bit0 | |
| 21 | G1 | I | Green Data Bit1 | |
| 22 | G2 | I | Green Data Bit2 | |
| 23 | G3 | I | Green Data Bit3 | |
| 24 | G4 | I | Green Data Bit4 | |
| 25 | G5 | I | Green Data Bit5 | |
| 26 | G6 | I | Green Data Bit6 | |
| 27 | G7 | I | Green Data Bit7 | |



| | | | | | |
|-----------------------|--------|------------------|----------|--------------|--------|
| Messrs. | | | | | |
| Product Specification | Model: | MTF-TQ35SP741-AV | Rev. No. | Issued Date. | Page. |
| | | | C | Jan.16, 08 | 9 / 31 |

| | | | | |
|----|-------------------|---|---|--------|
| 28 | R0 | I | Red Data Bit0 | |
| 29 | R1 | I | Red Data Bit1 | |
| 30 | R2 | I | Red Data Bit2 | |
| 31 | R3 | I | Red Data Bit3 | |
| 32 | R4 | I | Red Data Bit4 | |
| 33 | R5 | I | Red Data Bit5 | |
| 34 | R6 | I | Red Data Bit6 | |
| 35 | R7 | I | Red Data Bit7 | |
| 36 | H _{SYNC} | I | Horizontal Sync Input | Note 2 |
| 37 | V _{SYNC} | I | Vertical Sync Input | Note 2 |
| 38 | D _{CLK} | I | Dot Data Clock | |
| 39 | N/C | - | Not Connection | |
| 40 | N/C | - | Not Connection | |
| 41 | V _{CC} | I | Digital Power | 3.3V |
| 42 | V _{CC} | I | Digital Power | 3.3V |
| 43 | CSB | I | SPI Interface Data En Leave it open when not used! | Note 1 |
| 44 | N/C | - | Not Connection | |
| 45 | N/C | - | Not Connection | |
| 46 | N/C | - | Not Connection | |
| 47 | N/C | - | Not Connection | |
| 48 | SDO | - | SPI Interface Data output Leave it open when not used! | Note 1 |
| 49 | SP _{CLK} | I | SPI Interface Data Clock Leave it open when not used! | Note 1 |
| 50 | SDI | I | SPI Interface Data input Leave it open when not used! | Note 1 |
| 51 | N/C | - | Not Connection | |
| 52 | DEN | I | Data Enable Input | Note 3 |
| 53 | GND | I | Ground | |
| 54 | GND | I | Ground | |

Note 1: SPI Interface is only to set up the initial code in LCM driver IC register.

Note 2: There had been default initial code stored in LCD driver IC at Sync Mode operation, and if customer needs to revise the default initial code to change gamma or Vcom voltage, then SPI interface is needed.

Note 3: Different from Sync mode, there is no default initial code in driver IC in DE mode, so initial code has to be setup via SPI interface at DE mode.



Microtips Technology Inc.

| | | | | | |
|-----------------------|--------|------------------|----------|--------------|---------|
| Messrs. | | | | | |
| Product Specification | Model: | MTF-TQ35SP741-AV | Rev. No. | Issued Date. | Page. |
| | | | C | Jan.16, 08 | 10 / 31 |

3.2 Touch Panel Pin Assignment

| Pin No. | Designation |
|---------|-------------|
| 1 | Y1 (Top) |
| 2 | X1 (RIGHT) |
| 3 | Y2 (BOTTOM) |
| 4 | X2 (LEFT) |

4. OPTICAL CHARACTERISTICS

The following items are measured under stable conditions. The optical characteristics should be measured in a dark room or equivalent state with the methods shown in Note (1).

(Ta=25°C, Vcc = VCI=3.3V, If40mA)

| Item | | Symbol | Condition | Min | Type | Max | Unit | Note |
|--------------------|-------|---------------|--|-----|-------|-----|-------------------|--|
| Response time | Rise | T_R | Viewing normal Angle $\theta_x=\theta_y=0^\circ$ | -- | 15 | 30 | ms | All left side data are based on CMO's following condition-T6 NTSC:60% LC:5091 Light: C light (Machine:BM5A) Normal Polarizer without DBEF Simulation Data Reference only |
| | Fall | T_F | | -- | 35 | 50 | ms | |
| Brightness | | L | | 160 | 200 | -- | cd/m ² | |
| Contrast ratio | | CR | | 200 | 300 | -- | -- | |
| Color Chromaticity | Red | R_x | | -- | 0.591 | -- | -- | |
| | | R_y | | -- | 0.373 | -- | -- | |
| | Green | G_x | | -- | 0.331 | -- | -- | |
| | | G_y | | -- | 0.599 | -- | -- | |
| | Blue | B_x | | -- | 0.134 | -- | -- | |
| | | B_y | | -- | 0.171 | -- | -- | |
| White | W_x | -- | 0.295 | -- | -- | | | |
| | W_y | -- | 0.311 | -- | -- | | | |
| Viewing Angle | Hor. | θ_{x+} | Center CR \geq 10 | 50 | 60 | -- | Degree | |
| | | θ_{x-} | | 50 | 60 | -- | | |
| | Ver. | θ_{y+} | | 40 | 50 | -- | | |
| | | θ_{y-} | | 50 | 60 | -- | | |

Note 1: Definition of Contrast Ratio (CR):

The contrast ratio can be calculated by the following expression.

Contrast Ratio (CR)= L63/L0

L63: Luminance of gray level 63

L0: Luminance of gray level 0

CR=CR (10)

CR(X) is corresponding to the Contrast Ratio of the point X at Figure in Note (5)



Microtips Technology Inc.

| | | | | | |
|-----------------------|--------|------------------|----------|--------------|---------|
| Messrs. | | | | | |
| Product Specification | Model: | MTF-TQ35SP741-AV | Rev. No. | Issued Date. | Page. |
| | | | C | Jan.16, 08 | 11 / 31 |

Note 2: Definition of Response Time (T_R T_F):

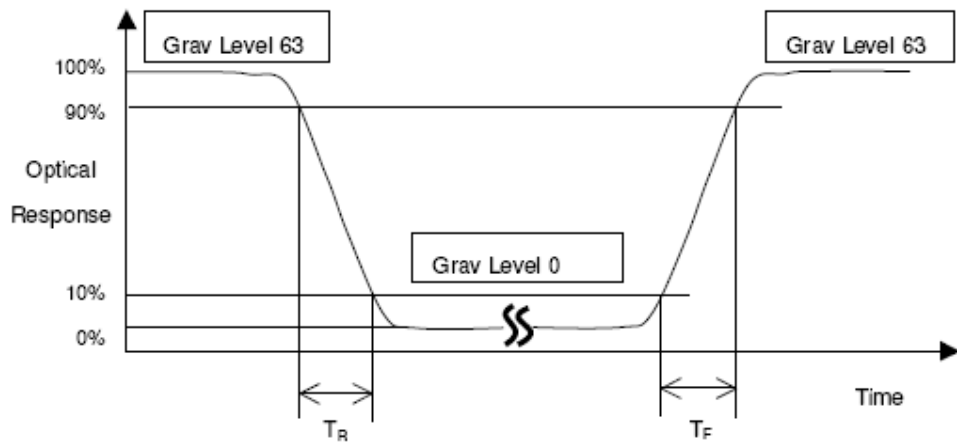

Note 3: Definition of Viewing Angle

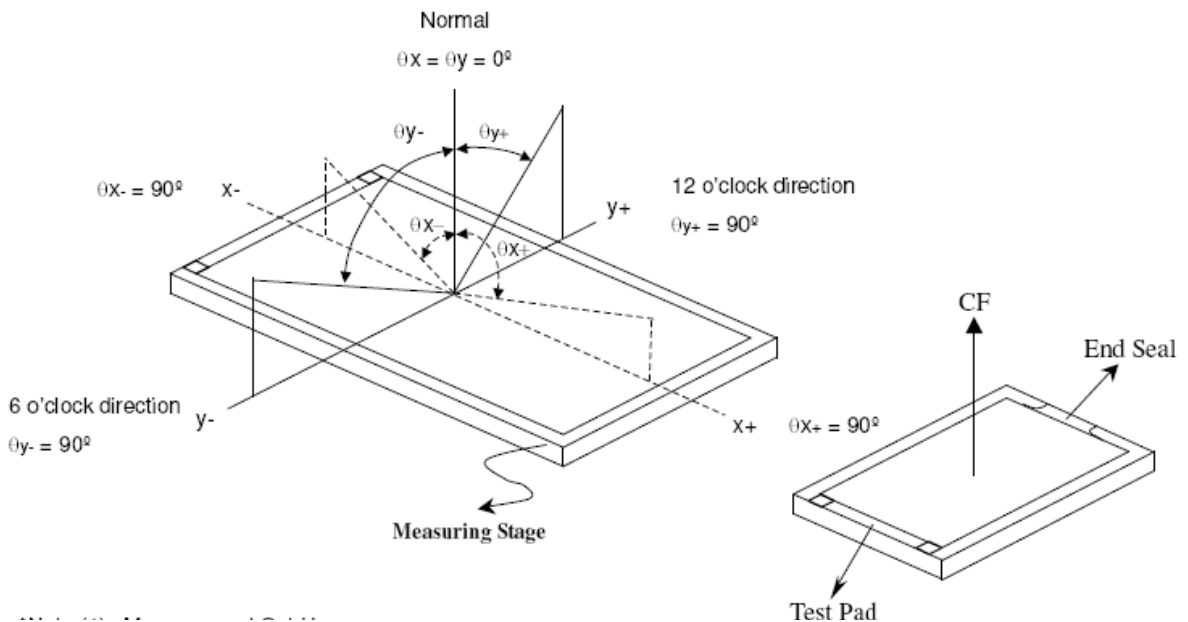

Microtips Technology Inc.

| | | | | | |
|-----------------------|--------|------------------|----------|--------------|---------|
| Messrs. | | | | | |
| Product Specification | Model: | MTF-TQ35SP741-AV | Rev. No. | Issued Date. | Page. |
| | | | C | Jan.16, 08 | 12 / 31 |

(4) Measurement Set-Up:

The LCD module should be stabilized at a given temperature for 20 minutes to avoid abrupt temperature change during measuring. In order to stabilize the luminance, the measurement should be executed after lighting Backlight for 20 minutes in a windless room.

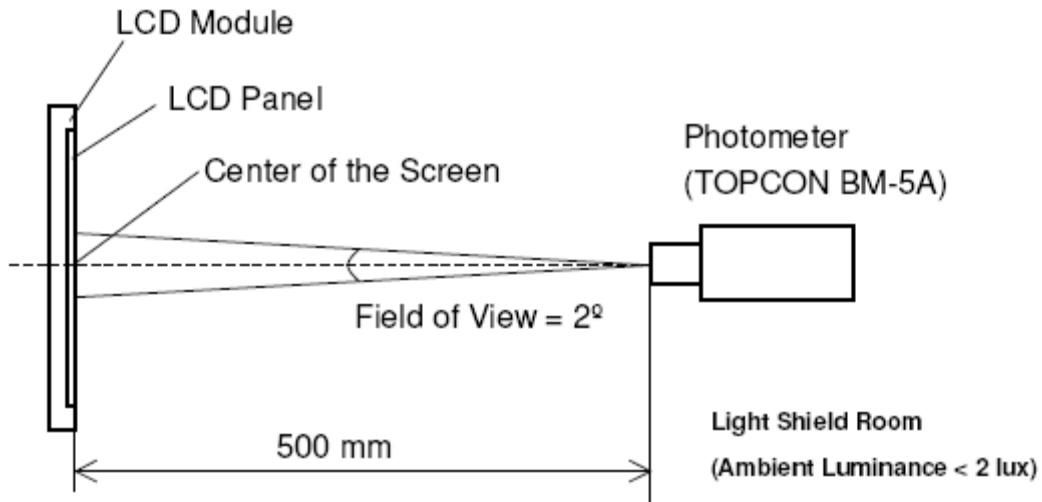

(5) Measurement Set-Up:

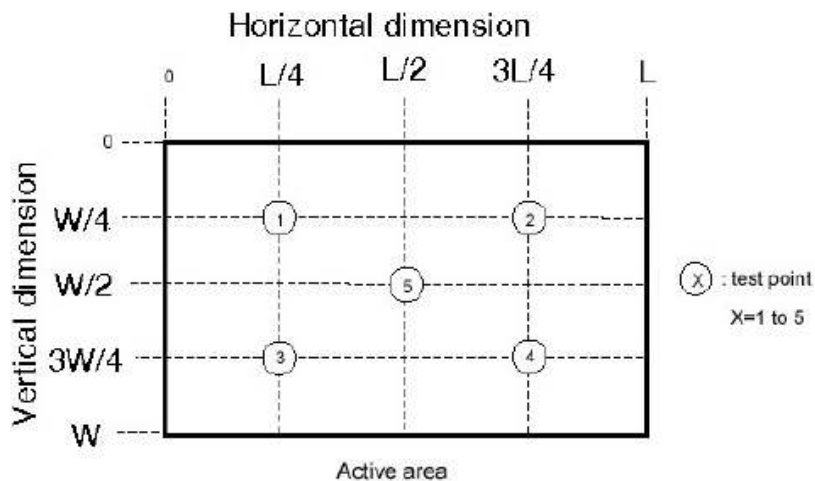

| | | | | | |
|-----------------------|--------|------------------|----------|--------------|---------|
| Messrs. | | | | | |
| Product Specification | Model: | MTF-TQ35SP741-AV | Rev. No. | Issued Date. | Page. |
| | | | C | Jan.16, 08 | 13 / 31 |

5. ABSOLUTE MAXIMUM RATINGS

5.1 Absolute Ratings of Environment

If the operating condition exceeds the following absolute maximum ratings, the TFT LCD module may be damaged permanently.

(Ta=25(2°C, VSS=GND=0)

| Item | Symbol | Min. | Max. | Unit | Note |
|--|--------|------|------|------|----------|
| Storage temperature | TSTG | -30 | 80 | °C | (1) |
| Operating temperature (Ambient temperature) | TOPR | -20 | 70 | °C | (1), (2) |

Note (1) 95 % RH Max. (40 °C ≥ Ta)

Maximum wet-bulb temperature at 39 °C or less. (Ta > 40 °C) No condensation.

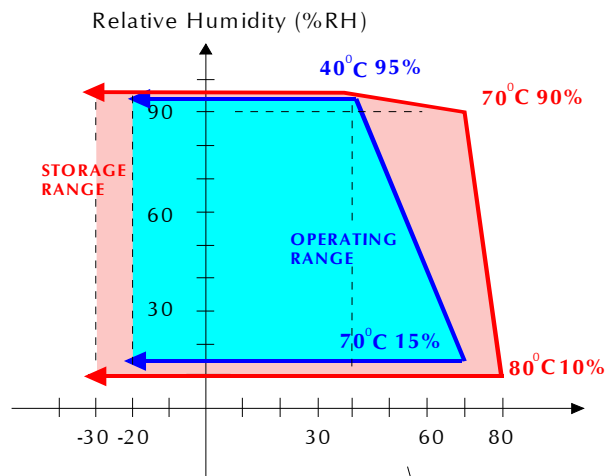

(2) In case of below 0°, the response time of liquid crystal (LC) becomes slower and the color of panel becomes darker than normal one. Level of retardation depends on temperature, because of LC's character

5.2 Maximum Ratings (Voltage Referenced to VSS)

| Item | Symbol | Condition | Min. | Max. | Unit | Remark |
|---------------|-----------------|-----------|------|---------|------|--------|
| Power voltage | VCC | VSS=0 | -0.3 | 6.0 | V | |
| Input voltage | V _{in} | | -0.3 | VCC+0.3 | V | Note 1 |

Note1:Hsync, Vsync, DEN, DCLK, R0~R7, G0~G7, B0~B7



Microtips Technology Inc.

| | | | | | |
|-----------------------|--------|------------------|----------|--------------|---------|
| Messrs. | | | | | |
| Product Specification | Model: | MTF-TQ35SP741-AV | Rev. No. | Issued Date. | Page. |
| | | | C | Jan.16, 08 | 14 / 31 |

6. ELECTRICAL CHARACTERISTICS

6.1 DC Electrical Characteristics

(Unless otherwise specified, Voltage Referenced to Vss, VCC=3.3V, Ta=25°C)

| Item | | Symbol | Value | | | Unit | |
|-------------------------|---------|----------|---------|-------|---------|------|--------|
| | | | Min. | Typ. | Max. | | |
| Power supply | | VCC | 3.0 | 3.3 | 3.6 | V | |
| Input Voltage for logic | H Level | V_{IH} | 0.7 VCC | - | VCC | V | Note 1 |
| | L Level | V_{IL} | 0 | - | 0.3 VCC | V | |
| Power Supply current | | ICC | - | 34.36 | - | mA | Note 2 |

Note1: Hsync, Vsync, DEN, DCLK, R0~R7, G0~G7, B0~B7

Note2: fV =60Hz , Ta=25°C , Display pattern : All Black



Microtips Technology Inc.

| | | | | | |
|-----------------------|--------|------------------|----------|--------------|---------|
| Messrs. | | | | | |
| Product Specification | Model: | MTF-TQ35SP741-AV | Rev. No. | Issued Date. | Page. |
| | | | C | Jan.16, 08 | 15 / 31 |

7. AC CHARACTERISTICS

7.1 Pixel timing

(Unless otherwise specified, Voltage Referenced to V_{SS} , $V_{CCIO}=3.3V$, $T_a=25^\circ C$)

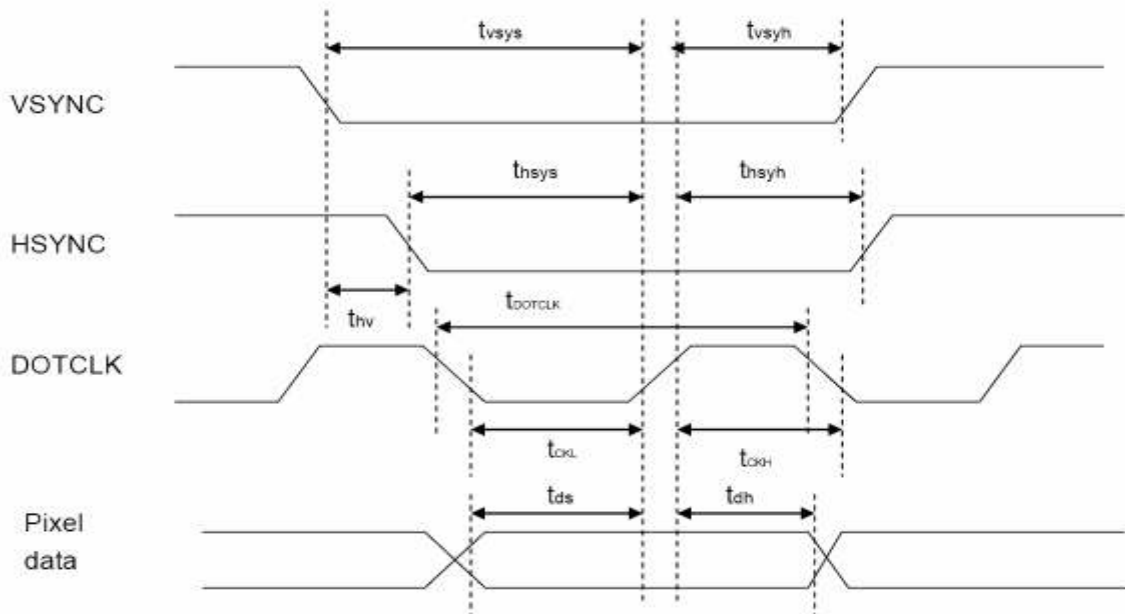

| PARAMETER | Symbol | Min. | | Typ. | | Max. | | Unit |
|--|---------|--------|-------|--------|-------|--------|-------|---------|
| | | 24 bit | 8 bit | 24 bit | 8 bit | 24 bit | 8 bit | |
| DOTCLK Frequency | fDOTCLK | - | - | 6.5 | 19.5 | 10 | 30 | MHz |
| DOTCLK Period | tDOTCLK | 100 | 33.3 | 154 | 51.3 | - | - | ns |
| Vertical Sync Setup Time | tvsys | 20 | 10 | - | - | - | - | ns |
| Vertical Sync Hold Time | tvsyh | 20 | 10 | - | - | - | - | ns |
| Horizontal Sync Setup Time | thsys | 20 | 10 | - | - | - | - | ns |
| Horizontal Sync Hold Time | thsyh | 20 | 10 | - | - | - | - | ns |
| Phase difference of Sync Signal Falling Edge | thv | 1 | | - | | 240 | | tDOTCLK |
| DOTCLK Low Period | tCKL | 50 | 15 | - | - | - | - | ns |
| DOTCLK High Period | tCKH | 50 | 15 | - | - | - | - | ns |
| Data Setup Time | tds | 12 | 10 | - | - | - | - | ns |
| Data hold Time | tdh | 12 | 10 | - | - | - | - | ns |
| Reset Pulse Width | tRES | 10 | | - | - | - | - | us |

Note: External clock source must be provided to DOTCLK pin of HX8238-A. The driver will not operate if absent of the clocking signal.



Microtips Technology Inc.

Messrs.

| | | | | | |
|-----------------------|--------|------------------|----------|--------------|---------|
| Product Specification | Model: | MTF-TQ35SP741-AV | Rev. No. | Issued Date. | Page. |
| | | | C | Jan.16, 08 | 16 / 31 |

7.2 Data transaction timing in parallel RGB (24 bit) interface (SYNC mode)

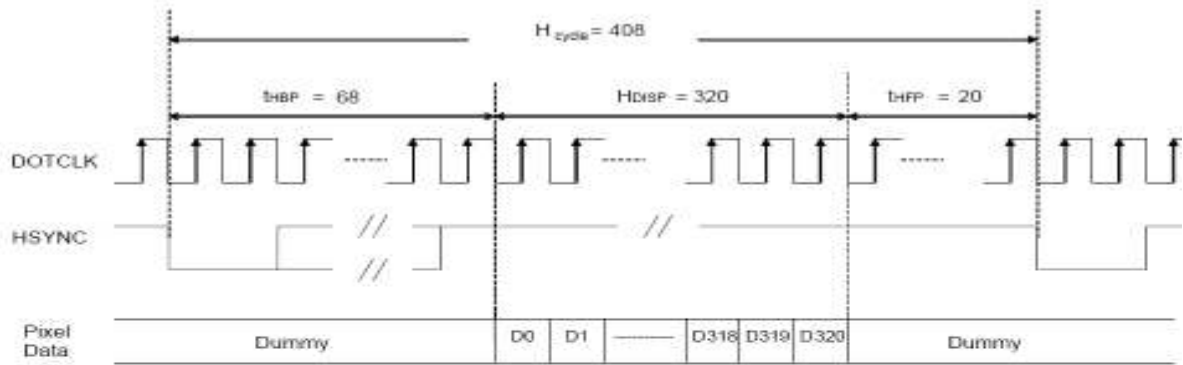

a) Horizontal Data Transaction Timing

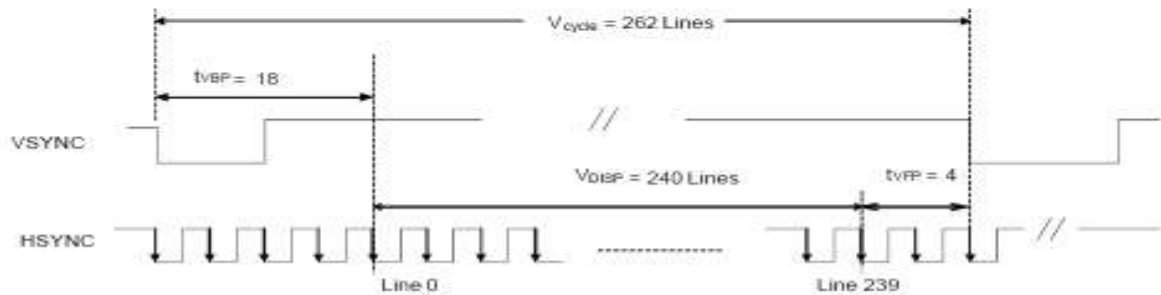

b) Vertical Data Transaction Timing

Data transaction timing in parallel RGB (24 bit) interface (SYNC mode)

| PARAMETER | Symbol | Min. | | Typ. | | Max. | | Unit |
|------------------------------|-----------|--------|-------|--------|-------|--------|-------|---------|
| | | 24 bit | 8 bit | 24 bit | 8 bit | 24 bit | 8 bit | |
| DOTCLK Frequency | fDOTCLK | - | - | 6.5 | 19.5 | 10 | 30 | MHz |
| DOTCLK Period | tDOTCL | 100 | 33.3 | 154 | 51.3 | - | - | Ns |
| Horizontal Frequency (Line) | fH | - | | 14.9 | | 22.35 | | KHz |
| Vertical Frequency (Refresh) | fV | - | | 60 | | 90 | | Hz |
| Horizontal Back Porch | tHBP | - | - | 68 | 204 | - | - | tDOTCLK |
| Horizontal Front Porch | tHFP | - | - | 20 | 60 | - | - | tDOTCLK |
| Horizontal Data Start Point | tHBP | - | - | 68 | 204 | - | - | tDOTCLK |
| Horizontal Blanking Period | tHBP+tHFP | - | - | 88 | 264 | - | - | tDOTCLK |
| Horizontal Display Area | HDISP | - | - | 320 | 960 | - | - | tDOTCLK |
| Horizontal Cycle | Hcycle | - | - | 408 | 1224 | 450 | 1350 | tDOTCLK |



Microtips Technology Inc.

| | | | | | |
|-----------------------|--------|------------------|----------|--------------|---------|
| Messrs. | | | | | |
| Product Specification | Model: | MTF-TQ35SP741-AV | Rev. No. | Issued Date. | Page. |
| | | | C | Jan.16, 08 | 17 / 31 |

7.3 Signal timing in DE mode

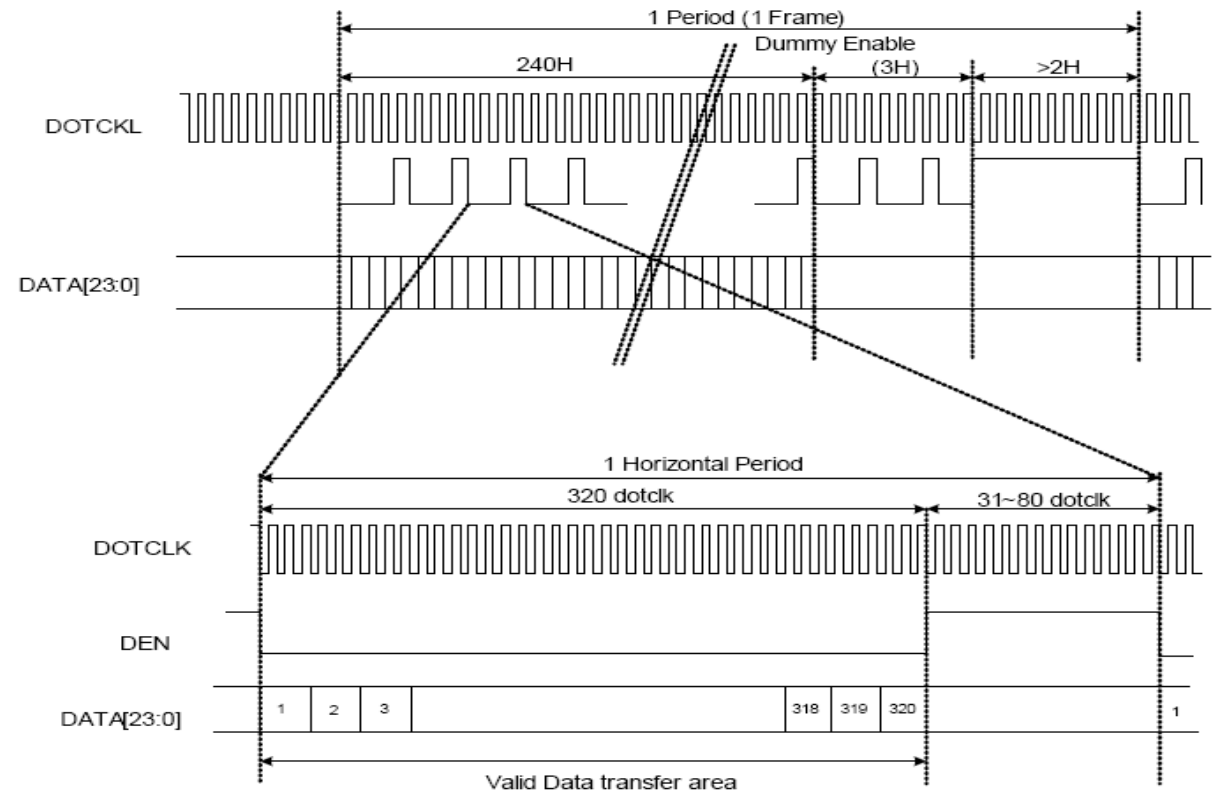

| | | | | | |
|-----------------------|--------|------------------|----------|--------------|---------|
| Messrs. | | | | | |
| Product Specification | Model: | MTF-TQ35SP741-AV | Rev. No. | Issued Date. | Page. |
| | | | C | Jan.16, 08 | 18 / 31 |

8. BACKLIGHT SPECIFICATIONS

8.1 Absolute Maximum Ratings

Ta = 25°C

| Parameter | Symbol | Maximun Rating | Units |
|-----------------------|------------------|----------------|-------|
| Peak Forward Current | I _{FM} | 40 | mA |
| Reverse Voltage | V _R | 20 | V |
| Power Dissipation | Pd | 456 | mW |
| Operating Temperature | T _{OPR} | -20~+70 | °C |
| Storage Temperature | T _{STG} | -30~+80 | °C |

8.2 Electrical/Operating Characteristics

Ta = 25°C

| Parameter | Symbol | Min. | Typ. | Max. | Units | Test Condition |
|------------------------------|----------------|------|-------|------|-------|--------------------|
| Forward Voltage(VLED1\VLED2) | V _F | 9.0 | 10.2 | 11.4 | V | Ta=25°C IF=40mA |
| LED (1+2) Current | I _L | - | 20+20 | - | mA | |
| Uniformity | - | 75 | - | - | % | |
| Chromaticity Coordinates | X | 0.27 | 0.30 | 0.32 | - | |
| | Y | 0.27 | 0.31 | 0.33 | - | |

*Uniformity = (Min./Max.) x 100%

8.3 Electrical Circuit of Backlight

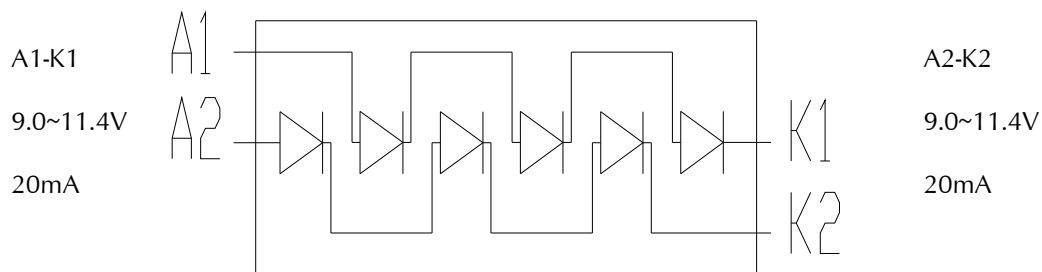

Microtips Technology Inc.

| | | | | | |
|-----------------------|--------|------------------|----------|--------------|---------|
| Messrs. | | | | | |
| Product Specification | Model: | MTF-TQ35SP741-AV | Rev. No. | Issued Date. | Page. |
| | | | C | Jan.16, 08 | 19 / 31 |

9. BASIC DISPLAY COLOR AND GRAY SCALE

| Color | | Input Color Data | | | | | | | | | | | | | | | | | | | | | | | |
|--------------|-------------------|------------------|----|----|----|-----|----|----|----|-------|----|----|----|-----|----|----|----|------|----|----|----|-----|----|----|----|
| | | Red | | | | | | | | Green | | | | | | | | Blue | | | | | | | |
| | | MSB | | | | LSB | | | | MSB | | | | LSB | | | | MSB | | | | LSB | | | |
| | | R7 | R6 | R5 | R4 | R3 | R2 | R1 | R0 | G7 | G6 | G5 | G4 | G3 | G2 | G1 | G0 | B7 | B6 | B5 | B4 | B3 | B2 | B1 | B0 |
| Basic Colors | Black | 0 | 0 | 0 | 0 | 0 | 0 | 0 | 0 | 0 | 0 | 0 | 0 | 0 | 0 | 0 | 0 | 0 | 0 | 0 | 0 | 0 | 0 | 0 | 0 |
| | Red(255) | 1 | 1 | 1 | 1 | 1 | 1 | 1 | 1 | 0 | 0 | 0 | 0 | 0 | 0 | 0 | 0 | 0 | 0 | 0 | 0 | 0 | 0 | 0 | 0 |
| | Green(255) | 0 | 0 | 0 | 0 | 0 | 0 | 0 | 0 | 1 | 1 | 1 | 1 | 1 | 1 | 1 | 1 | 0 | 0 | 0 | 0 | 0 | 0 | 0 | 0 |
| | Blue(255) | 0 | 0 | 0 | 0 | 0 | 0 | 0 | 0 | 0 | 0 | 0 | 0 | 0 | 0 | 0 | 0 | 1 | 1 | 1 | 1 | 1 | 1 | 1 | 1 |
| | Cyan | 0 | 0 | 0 | 0 | 0 | 0 | 0 | 0 | 1 | 1 | 1 | 1 | 1 | 1 | 1 | 1 | 1 | 1 | 1 | 1 | 1 | 1 | 1 | 1 |
| | Magenta | 1 | 1 | 1 | 1 | 1 | 1 | 1 | 1 | 0 | 0 | 0 | 0 | 0 | 0 | 0 | 0 | 1 | 1 | 1 | 1 | 1 | 1 | 1 | 1 |
| | Yellow | 1 | 1 | 1 | 1 | 1 | 1 | 1 | 1 | 1 | 1 | 1 | 1 | 1 | 1 | 1 | 1 | 0 | 0 | 0 | 0 | 0 | 0 | 0 | 0 |
| | White | 1 | 1 | 1 | 1 | 1 | 1 | 1 | 1 | 1 | 1 | 1 | 1 | 1 | 1 | 1 | 1 | 1 | 1 | 1 | 1 | 1 | 1 | 1 | 1 |
| Red | Red(0) Dark | 0 | 0 | 0 | 0 | 0 | 0 | 0 | 0 | 0 | 0 | 0 | 0 | 0 | 0 | 0 | 0 | 0 | 0 | 0 | 0 | 0 | 0 | 0 | 0 |
| | Red(1) | 0 | 0 | 0 | 0 | 0 | 0 | 0 | 1 | 0 | 0 | 0 | 0 | 0 | 0 | 0 | 0 | 0 | 0 | 0 | 0 | 0 | 0 | 0 | 0 |
| | Red(2) | 0 | 0 | 0 | 0 | 0 | 0 | 1 | 0 | 0 | 0 | 0 | 0 | 0 | 0 | 0 | 0 | 0 | 0 | 0 | 0 | 0 | 0 | 0 | 0 |
| | : | : | : | : | : | : | : | : | : | : | : | : | : | : | : | : | : | : | : | : | : | : | : | : | : |
| | Red(253) | 1 | 1 | 1 | 1 | 1 | 1 | 0 | 1 | 0 | 0 | 0 | 0 | 0 | 0 | 0 | 0 | 0 | 0 | 0 | 0 | 0 | 0 | 0 | 0 |
| | Red(254) | 1 | 1 | 1 | 1 | 1 | 1 | 1 | 0 | 0 | 0 | 0 | 0 | 0 | 0 | 0 | 0 | 0 | 0 | 0 | 0 | 0 | 0 | 0 | 0 |
| | Red(255) Bright | 1 | 1 | 1 | 1 | 1 | 1 | 1 | 1 | 0 | 0 | 0 | 0 | 0 | 0 | 0 | 0 | 0 | 0 | 0 | 0 | 0 | 0 | 0 | 0 |
| Green | Green(0) Dark | 0 | 0 | 0 | 0 | 0 | 0 | 0 | 0 | 0 | 0 | 0 | 0 | 0 | 0 | 0 | 0 | 0 | 0 | 0 | 0 | 0 | 0 | 0 | 0 |
| | Green(1) | 0 | 0 | 0 | 0 | 0 | 0 | 0 | 0 | 0 | 0 | 0 | 0 | 0 | 0 | 0 | 1 | 0 | 0 | 0 | 0 | 0 | 0 | 0 | 0 |
| | Green(2) | 0 | 0 | 0 | 0 | 0 | 0 | 0 | 0 | 0 | 0 | 0 | 0 | 0 | 0 | 1 | 0 | 0 | 0 | 0 | 0 | 0 | 0 | 0 | 0 |
| | : | : | : | : | : | : | : | : | : | : | : | : | : | : | : | : | : | : | : | : | : | : | : | : | |
| | Green(253) | 0 | 0 | 0 | 0 | 0 | 0 | 0 | 0 | 1 | 1 | 1 | 1 | 1 | 1 | 0 | 1 | 0 | 0 | 0 | 0 | 0 | 0 | 0 | 0 |
| | Green(254) | 0 | 0 | 0 | 0 | 0 | 0 | 0 | 0 | 1 | 1 | 1 | 1 | 1 | 1 | 1 | 0 | 0 | 0 | 0 | 0 | 0 | 0 | 0 | 0 |
| | Green(255) Bright | 0 | 0 | 0 | 0 | 0 | 0 | 0 | 0 | 1 | 1 | 1 | 1 | 1 | 1 | 1 | 1 | 0 | 0 | 0 | 0 | 0 | 0 | 0 | 0 |
| Blue | Blue(0) Dark | 0 | 0 | 0 | 0 | 0 | 0 | 0 | 0 | 0 | 0 | 0 | 0 | 0 | 0 | 0 | 0 | 0 | 0 | 0 | 0 | 0 | 0 | 0 | 0 |
| | Blue(1) | 0 | 0 | 0 | 0 | 0 | 0 | 0 | 0 | 0 | 0 | 0 | 0 | 0 | 0 | 0 | 0 | 0 | 0 | 0 | 0 | 0 | 0 | 0 | 1 |
| | Blue(2) | 0 | 0 | 0 | 0 | 0 | 0 | 0 | 0 | 0 | 0 | 0 | 0 | 0 | 0 | 0 | 0 | 0 | 0 | 0 | 0 | 0 | 0 | 1 | 0 |
| | : | : | : | : | : | : | : | : | : | : | : | : | : | : | : | : | : | : | : | : | : | : | : | : | |
| | Blue(253) | 0 | 0 | 0 | 0 | 0 | 0 | 0 | 0 | 0 | 0 | 0 | 0 | 0 | 0 | 0 | 0 | 1 | 1 | 1 | 1 | 1 | 1 | 0 | 1 |
| | Blue(254) | 0 | 0 | 0 | 0 | 0 | 0 | 0 | 0 | 0 | 0 | 0 | 0 | 0 | 0 | 0 | 0 | 1 | 1 | 1 | 1 | 1 | 1 | 1 | 0 |
| | Blue(255) Bright | 0 | 0 | 0 | 0 | 0 | 0 | 0 | 0 | 0 | 0 | 0 | 0 | 0 | 0 | 0 | 0 | 1 | 1 | 1 | 1 | 1 | 1 | 1 | 1 |



| | | | | | |
|-----------------------|--------|------------------|----------|--------------|---------|
| Messrs. | | | | | |
| Product Specification | Model: | MTF-TQ35SP741-AV | Rev. No. | Issued Date. | Page. |
| | | | C | Jan.16, 08 | 20 / 31 |

10. QUALITY STANDARD FOR LCD

10.1 Objective

This specification book is the standard for LCD module general inspection. And also this book will be refer to customer approval specification.

10.2 Scope

This specification book is applicable to general LCD module. If supplier has any doubt or requirement, then it can be discussed.

10.2.1 Acceptable Quality Level

| INSPECTION | SAMPLING PROCEDURES | A.Q.L |
|------------|---|-------|
| Major | MIL-STD-105E Inspection Level II Normal Inspection Single sample inspection | 1 |
| Minor | MIL-STD-105E Inspection Level II Normal Inspection Single sample inspection | 1.5 |

Major defect :

A major defect is a defect that could result in failure or extremely reduction on the usability of the product for its intended purpose.

Minor defect :

A minor defect is one that does not materially reduce the usability of the product for its intended purpose or is a departure from established standards giving no significant bearing on the effective use or operation of the unit.

10.2.2 Inspection Conditions

10.2.2.1 The environmental conditions for inspection shall be as follows

- Room Temperature : 25±10°C
- Humidity Temperature : 45±20%RH

10.2.3 The external visual inspection

- The inspection shall be performed by using 40Watts fluorescent lamp for illumination and the distance between LCD and eyes of the inspector shall be 30cm or more.



| | | | | | |
|-----------------------|--------|------------------|----------|--------------|---------|
| Messrs. | | | | | |
| Product Specification | Model: | MTF-TQ35SP741-AV | Rev. No. | Issued Date. | Page. |
| | | | C | Jan.16, 08 | 21 / 31 |

10.2.4 Inspection Item

| | |
|--|---|
| Pinhole, Bright spot, Black spot, White spot, Black line, White Line, Foreign particle, Bubble | The color of a small area is different from the remainder. The phenomenon dose not change with voltage. |
| Contrast variation | The color of a small area is different from the remainder. The phenomenon change with voltage. |
| Glass defect | Glass crack, Chip |
| Operating | Function, Contrast, Uniformity, Components |

10.2.5 Definition of the Area

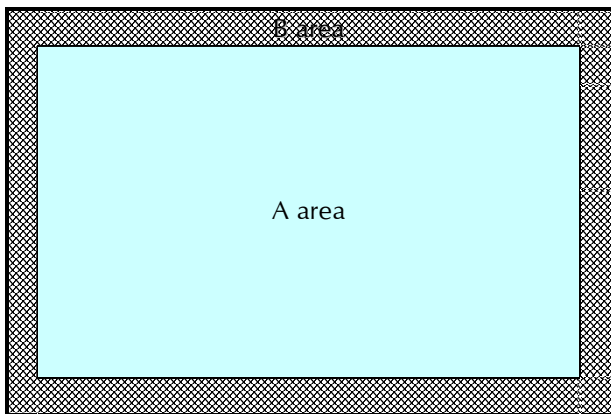

A area: Viewing Area
 B area: Out of Viewing Area



| | | | | | |
|-----------------------|--------|------------------|----------|--------------|---------|
| Messrs. | | | | | |
| Product Specification | Model: | MTF-TQ35SP741-AV | Rev. No. | Issued Date. | Page. |
| | | | C | Jan.16, 08 | 22 / 31 |

10.3 Inspection specification

10.3.1 Non-operating inspection specification

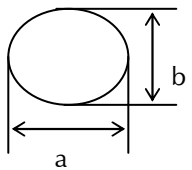
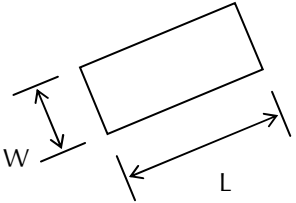
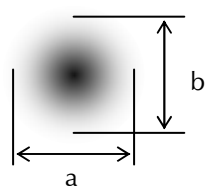
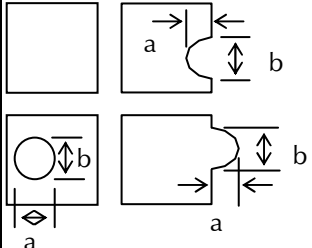
| Class of defects | No. | Inspection Item | Criteria of defects | | Acceptable Q'ty | | |
|---|---|---|---|-----------------------|-----------------|--------|--------|
| | | | | | Zone A | Zone B | |
| Major | 1 | Circuits | 1. Circuit short | | 0 | 0 | |
| | | | 2. Circuit open | | | | |
| Minor | 2 | Black spot, White spot, Bright spot, Foreign particle  $\phi = (a+b)/2$ | A | $\phi \leq 0.1$ | * | Ignore | |
| | | | B | $0.1 < \phi < 0.2$ | 3 | | |
| | | | C | $0.2 \leq \phi < 0.3$ | 1 | | |
| | | | D | $0.3 \leq \phi$ | 0 | | |
| | | | Total defect point (B,C) | | 3 | | |
| | | | * Reject when 5 or more spots are gathered within 5mm circle. | | | | |
| | 3 | Black line, White line  | A | $W \leq 0.02$ | - | * | Ignore |
| | | | B | $0.02 < W \leq 0.05$ | $L \leq 5$ | 2 | |
| | | | C | $0.05 < W \leq 0.1$ | $L \leq 3$ | 2 | |
| | | | D | $0.1 < W$ | - | 0 | |
| Total defect point (B,C) | | | 3 | | | | |
| * Reject when 5 or more spots are gathered within 5mm circle. | | | | | | | |
| 4 | Contrast variation  $\phi = (a+b)/2$ | A | $\phi \leq 0.3$ | Ignore | Ignore | | |
| | | B | $0.3 < \phi \leq 0.4$ | 2 | | | |
| | | C | $0.4 < \phi \leq 0.5$ | 1 | | | |
| | | D | $0.5 < \phi$ | 0 | | | |
| | | Total defect point (B,C) | | 3 | | | |
| | | | | | | | |
| 5 | Pattern deformity  $\phi = (a+b)/2$ | 1. Pin hole | | | | | |
| | | A | $\phi \leq 0.15$ | Ignore | Ignore | | |
| | | B | $0.15 < \phi \leq 0.2$ | 2 (*) | | | |
| | | | $0.2 < \phi$ | 0 | | | |
| | | * Two pin hole shall not formed in the single dot | | | | | |
| | | 2. Excess, void | | | | | |
| A | $a \leq 0.2$ and $b \leq 0.2$ | Ignore | Ignore | | | | |
| B | $0.2 < a$ or $0.2 < b$ | 0 | | | | | |



| | | | | | |
|-----------------------|--------|------------------|----------|--------------|---------|
| Messrs. | | | | | |
| Product Specification | Model: | MTF-TQ35SP741-AV | Rev. No. | Issued Date. | Page. |
| | | | C | Jan.16, 08 | 23 / 31 |

| | | | | | | |
|-------|-------------------|--|--|-----------------------|------------|--------|
| Minor | 6 | Dot defect | A | Bright dot | $N \leq 2$ | Ignore |
| | | | B | Dark dot | $N \leq 3$ | |
| | | | C | Total defect dot | $N \leq 4$ | |
| | | | * This inspection item does not apply to B/W LCD | | | |
| | 7 | Bubble between Polarizer and panel | A | $\phi \leq 0.3$ | Ignore | Ignore |
| | | | B | $0.3 < \phi \leq 0.5$ | 2 | |
| | | | C | $0.5 < \phi$ | 0 | |
| | 8 | Polarizer scratch and particle | Circular : Same as inspection item No.2 | | | Ignore |
| | | | Linear : Same as inspection item No.3 | | | |
| | 9 | Polarizer Dent | A | $\phi \leq 0.2$ | Ignore | Ignore |
| | | | B | $0.2 < \phi \leq 0.3$ | 2 | |
| | | | C | $0.3 < \phi \leq 0.4$ | 1 | |
| | | | D | $0.4 < \phi$ | 0 | |
| | | | Total defect point (B,C) | | | 3 |
| | 10 | Bubble in the Cell | Any size | | 0 | 0 |
| 11 | Dirt on polarizer | Dirt which can be wiped easily should be accepted. | | | | |
| 12 | Protection film | The protection film should not be stripped up to viewing area and the peeled off angle should not exceed 20 degrees. | | | | |
| 13 | Polarizer shift | 1. Shifting in position should not exceed the glass outline dimension. 2. Incomplete covering of the viewing area due to shifting is not allowed. 3. Shifting in position should be within the tolerance (refer to module dimensional drawing) | | | | |
| 14 | Silicon | 1. Silicon must cover all circuits. 2. Silicon thickness should be within specification (refer to module dimensional drawing) | | | | |
| 15 | Tape | 1. Location: refer to specification. 2. Insufficient adhesive. | | | | |
| Major | 16 | TCP, FPC defect | Film or Pattern should not have crack. | | | |
| | 17 | Components | Missing components not allowed. | | | |

* Condition of item 2~9

1. Distance between defects must be more than 10mm with light on, more than 15mm with light off.
2. Total acceptable defect number
 - Defects with light on : 6 points



Microtips Technology Inc.

| | | | | | |
|-----------------------|--------|------------------|----------|--------------|---------|
| Messrs. | | | | | |
| Product Specification | Model: | MTF-TQ35SP741-AV | Rev. No. | Issued Date. | Page. |
| | | | C | Jan.16, 08 | 24 / 31 |

| Class of defects | No. | Inspection Item | Criteria of defects |
|------------------|-----|---------------------------------------|--|
| Major | 1 | No display | -- |
| | 2 | Abnormal operation | -- |
| | 3 | Contrast defect | Judge according to module specification. Establish boundary sample if required. |
| | 4 | Viewing angle defect | Judge according to module specification. Establish boundary sample if required. |
| | 5 | Excess power consumption | Judge according to module specification. |
| | 6 | Back-light, LED defect | 1. No lit-on 2. Different color 3. Low brightness |
| | 7 | Speaker, Vibrator defect | 1. No operation 2. Abnormal operation |
| Minor | 8 | Cross-talk defect | No noticeable crosstalk. Establish boundary sample if required. |
| | 9 | Uneven brightness | No noticeable unevenness allowed. Establish boundary sample if required. |
| | 10 | Uneven color | No noticeable unevenness allowed. Establish boundary sample if required. |
| | 11 | Spot, Pinhole, Foreign particle, Line | Same as in Chapter 7.1 |



| | | | | | |
|-----------------------|--------|------------------|----------|--------------|---------|
| Messrs. | | | | | |
| Product Specification | Model: | MTF-TQ35SP741-AV | Rev. No. | Issued Date. | Page. |
| | | | C | Jan.16, 08 | 25 / 31 |

11. RELIABILITY CONDITION

11.1 LCM Reliability Test

11.1.1 Reliability Test Condition

| No. | TFT | Item | Condition | Test time | Note |
|-----|-----|------------------------------------|---|-----------|------|
| 1 | V | High temp. operating | 70°C | 240 Hrs | - |
| 2 | V | Low temp. operating | -20°C | 240 Hrs | - |
| 3 | V | High temp. storage | 80°C | 240 Hrs | - |
| 4 | V | Low temp. storage | -30°C | 240 Hrs | - |
| 5 | V | High Temp / High Humidity Storage | T = 60°C /90%. For (But no condensation dew) | 240 Hrs | - |
| 6 | V | High Temp/ High Humidity Operating | T = 40°C /90% For (But no condensation dew) | 240 Hrs | - |
| 7 | V | Thermal Shock | -30°C → +25°C → +80°C, 50 cycle 30min 5min 30min | - | - |

11.1.2 Operating Test Pattern

| No. | Items | Test Pattern |
|-----|-----------------------------------|---|
| 1 | Test Pattern in Driving Condition | 1. Full Red 2. Full Green 3. Full Blue 4. Gradation (horizontal) 5. Gradation (vertical) 6. Character (111111) 7. Full White 8. Full Black 9. Black Line (horizontal) 10. Black Line (vertical) 11. Mosaic (1X1) The Test Pattern is changed 1sec. The same Pattern are repeated. |
| 2 | Black Square | Black Window and White Background |



| | | | | | |
|-----------------------|--------|------------------|----------|--------------|---------|
| Messrs. | | | | | |
| Product Specification | Model: | MTF-TQ35SP741-AV | Rev. No. | Issued Date. | Page. |
| | | | C | Jan.16, 08 | 26 / 31 |

11.1.3 Test Method

The method of visual inspection is equal to the appearance standard. Evaluation and assessment made two hours after return to room temperature ($25 \pm 5^{\circ}\text{C}$). The LCDs subjected to the test must not have dew condensation.

The test pattern is gray scale and the operating voltage sweep from V_{th} to V_{sat} variable.

The non-uniformity and other appearance are checked in LCD.

11.1.4 Result Evaluation Criteria

There should be no change which might affect the practical display function when the display quality test is conducted under normal operating condition.

11.1.5 Life time

Life time expectancy of LCD Panel is approximately 50,000 hours under the room environment. Definition on the termination of life time is deterioration of contrast ratio by one fifth against initial value.

11.1.6 Basic rule for Reliability test

- * Place all the samples under room temperature & humidity for 24 hours after reliability stressing.
- * Room environment means $25 \pm 10^{\circ}\text{C}$, $45 \pm 20\% \text{RH}$
- * There should be no condensation during the test.
- * One LCD module shall be used for one test item only and once.

11.1.7 Judgment Criteria for reliability test No. 1-2

- * Contrast (or Brightness) ratio variation is within 50% of the initial value.
- * No abnormal function
- * No extreme decay on appearance

11.1.8 Life time

Display (LCD module) : Life time expectancy of LCD Panel is approximately 50,000 hours under the room environment.

11.2 Touch panel Reliability

| No. | Items | Min. | Typ. | Max. | Unit | Remark |
|-----|---------------------------|-----------|------|------|------------|---|
| 1 | Activation Force | 100 | 130 | 150 | g | 1. within active area. 2. R8.0mm polyacetal pen or finger. |
| 2 | Surface Hardness | 3 | - | - | H | Judgment ref. JIS-K5600 |
| 3 | Durability (Writing Life) | 100,000 | - | - | characters | 1. within active area. 2. R0.8mm polyacetal pen. 3. Load: 150g 4. Speed: 60mm/sec |
| 4 | Durability (Hitting Life) | 1,000,000 | - | - | touches | 1. within active area. 2. R0.8mm polyacetal pen. 3. Load: 250g 4. Frequency: 3 times/sec |



| | | | | | |
|-----------------------|--------|------------------|----------|--------------|---------|
| Messrs. | | | | | |
| Product Specification | Model: | MTF-TQ35SP741-AV | Rev. No. | Issued Date. | Page. |
| | | | C | Jan.16, 08 | 27 / 31 |

12. PRECAUTIONS





12.1 Operation

Burn-in sometimes happens when the same character was displayed at along time. Therefore, to prevent Burn-in, it is recommended to set up a Screen-saver function.

12.2 Safety

The liquid crystal in the LCD is poisonous, DO NOT put it in your mouth. If the liquid crystal touches your skin or clothes, wash it off immediately using soap and water.







12.3 Handling

| | |
|---|--|
|  | <p>a. The LCD module shall be installed flat, without twisting or bending. b. COF or FPC has narrow pattern width, so easily become open circuit by external force. DO NOT apply pressure to COF or FPC especially in bending area.</p> |
|  | <p>c. To avoid damage in appearance or malfunction, DO NOT subject the module to mechanical shock or to excessive force on its surface.</p> |
|  | <p>d. The polarizer attached to the display is very easy to damage, handle it with care to avoid scratching.</p> |
|  | <p>e. To avoid contamination on the display surface, DO NOT touch the display surface with bare hands. f. Provide a space so that the LCD module does not come into contact with other components.</p> |



Messrs.

| Product Specification | Model: | MTF-TQ35SP741-AV | Rev. No. | Issued Date. | Page. |
|-----------------------|--------|------------------|----------|--------------|---------|
| | | | C | Jan.16, 08 | 28 / 31 |

| | |
|---|---|
|  | <p>g. To protect the LCD panel from external pressure, put covering glass (acrylic board or similar board) to keep appropriate space between them.</p> |
|  | <p>h. Be careful for condensation at sudden temperature change. Condensation makes damage to polarizer or electrical contacted parts. And after fading condensation, smear or spot will occur.</p> |
|  | <p>i. Property of semiconductor devices may be affected when they are exposed to light possibly resulting in malfunctioning of the ICs. To prevent such malfunctioning of the ICs, your design and mounting layout done are so that the IC is not exposed to light in actual use.</p> |
|  | <p>j. Strong light exposure causes degradation of color filter. It may not recover</p> |
|  | <p>k. DO NOT contact with water to avoid Metal corrosion.</p> <p>l. When it is not in use, the screen must be turned off or the pattern must be frequently changed by a screen saver. If it displays the same pattern for a long period of time, brightness down/image sticking may develop due to the LCD structure.</p> |
|  | <p>m. Never disassemble LCD product under any circumstances. If unqualified operators or users assemble the product after disassembling it, it may not function or its operation may be seriously affected.</p> |



| | | | | | |
|-----------------------|--------|------------------|----------|--------------|---------|
| Messrs. | | | | | |
| Product Specification | Model: | MTF-TQ35SP741-AV | Rev. No. | Issued Date. | Page. |
| | | | C | Jan.16, 08 | 29 / 31 |

12.4 Static electricity

Since a module is composed of electronic circuits, it is not strong to electrostatic discharge.

| | |
|---|--|
|  | <ol style="list-style-type: none"> The LCD module shall be installed flat, without twisting or bending. Ground soldering iron tips, tools and testers when they operate. Ground your body when handling the products. DO NOT apply voltage to the input terminal without applying power supply. DO NOT apply voltage that exceeds the absolute maximum rating. Store the products in an anti-electrostatic container. Peel off protect tape, attached to polarizer, slowly to minimize ESD damage. |
|---|--|

12.5 Storage

| | |
|---|--|
|  | <p>Store the products in a dark place at +5 ~ +25 degree C, low humidity (50%RH or less). DO NOT store the products in an atmosphere containing organic solvents or corrosive gases.</p> |
|---|--|

12.6 Cleaning

| | |
|---|--|
|  | <ol style="list-style-type: none"> DO NOT wipe the polarizer with dry cloth, as it might cause scratch. Wipe the polarizer with a soft cloth soaked with petroleum IPA, other chemical might damage. |
|---|--|

12.7 Waste

| | |
|---|--|
|  | <p>When dispose of LCD module, manage it at the production waste according to the relevant laws and regulations.</p> |
|---|--|



| | | | | | |
|-----------------------|--------|------------------|----------|--------------|---------|
| Messrs. | | | | | |
| Product Specification | Model: | MTF-TQ35SP741-AV | Rev. No. | Issued Date. | Page. |
| | | | C | Jan.16, 08 | 30 / 31 |

13. WARRANTY

This product has been manufactured to your company's specifications as a part for use in your company's general electronic products. It is guaranteed to perform according to delivery specifications. For any other use apart from general electronic equipment, we cannot take responsibility if the product is used in medical devices, nuclear power control equipment, aerospace equipment, fire and security systems, or any other applications in which there is a direct risk to human life and where extremely high levels of reliability are required. If the product is to be used in any of the above applications, we will need to enter into a separate product liability agreement.

- 1 We cannot accept responsibility for any defect, which may arise from additional manufacturing of the product (including disassembly and reassembly), after product delivery.
- 2 We cannot accept responsibility for any defect, which may arise after the application of strong external force to the product.
- 3 We cannot accept responsibility for any defect, which may arise due to the application of static electricity after the product has passed your company's acceptance inspection procedures.
- 4 We cannot accept responsibility for industrial property, which may arise through the use of your product, with exception to those issues relating directly to the structure or method of manufacturing of our product. Microtips-origin longer than one year from Microtips production.

14. DIMENSIONAL OUTLINES

See Next page....



Microtips Technology Inc.

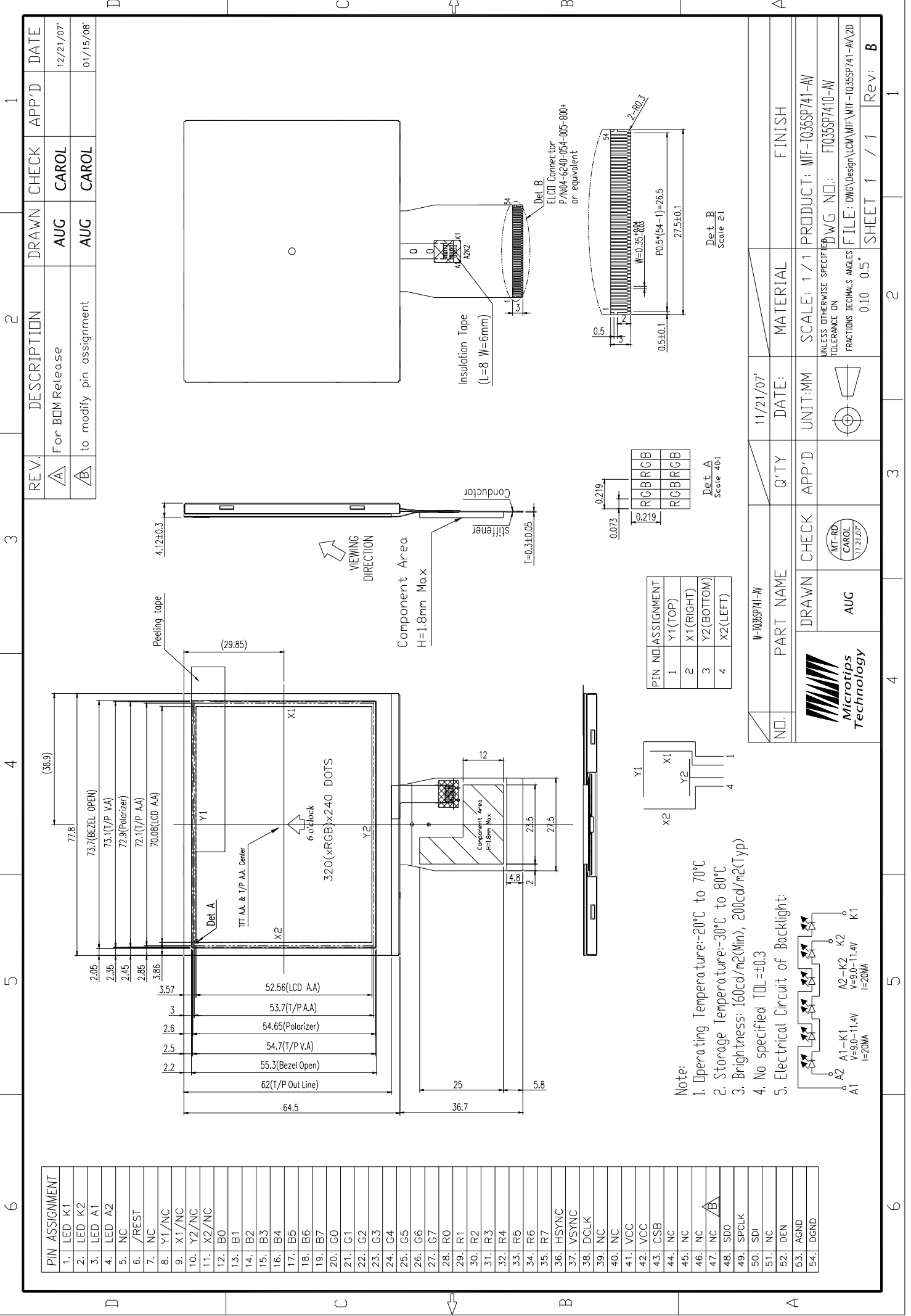

| REV. | DESCRIPTION | DRAWN | CHECK | APP'D | DATE |
|------|--------------------------|-------|-------|-------|----------|
| A | For BOM Release | AUG | CAROL | | 12/21/07 |
| B | to modify pin assignment | AUG | CAROL | | 01/15/08 |

| PIN NO | ASSIGNMENT |
|--------|------------|
| 1 | Y1(TOP) |
| 2 | X1(RIGHT) |
| 3 | Y2(BOTTOM) |
| 4 | X2(LEFT) |

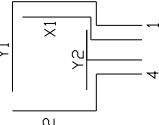

- Note:
- Operating Temperature: -20°C to 70°C
 - Storage Temperature: -30°C to 80°C
 - Brightness: 160cd/m²(Min), 200cd/m²(Typ)
 - No specified TOL=±0.3
 - Electrical Circuit of Backlight:

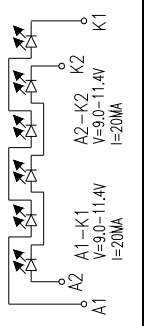

| NO. | PART NAME | Q'TY | DATE: | MATERIAL | FINISH |
|-----|----------------|------------------------|----------|---|---------------------------|
| | W-1035SP741-AW | | 11/21/07 | | |
| | DRAWN | CHECK | APP'D | SCALE: 1/1 | PRODUCT: MIF-1035SP741-AV |
| | AUG | MT-RD CAROL (11/21/07) | | UNLESS OTHERWISE SPECIFIED TOLERANCE ON FRACTIONS DECIMALS ANGLES 0.10 0.5° | DWG NO: F1035SP7410-AV |
| | | | | FILE: DWG\Design\LCM\MIF\MIF-1035SP741-AV.2D | SHEET 1 / 1 |
| | | | | | Rev: B |

