

# Multilayer Chip Bead Inductors (BK series)

## BK1005LL680-T

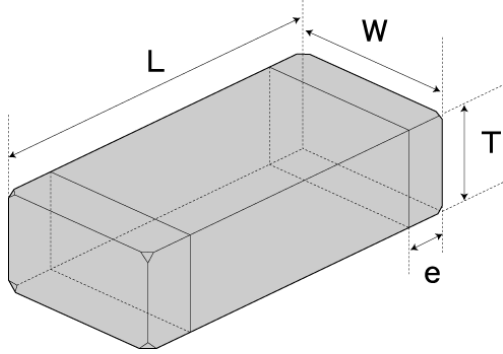

### ■ Features

- Item Summary  
68Ω, 400mA, 0402
- Lifecycle Stage  
Mass Production
- Standard packaging quantity (minimum)  
Taping 10000pcs

### ■ Products characteristics table

CaseSize (EIA/JIS)	0402/1005
Impedance	68Ω
Impedance Measuring Frequency	100MHz
Rated Current	400mA
DC Resistance (max)	0.31Ω
Temperature Range	-55°C to 125°C
RoHS Compliance	Yes
Halogen Free	Yes
Soldering Method	Reflow

### ■ External Dimensions

L	1mm ±0.05
W	0.5mm ±0.05
T	0.5mm ±0.05
e	0.25mm ±0.10

### ■ Typical Characteristics Fig.

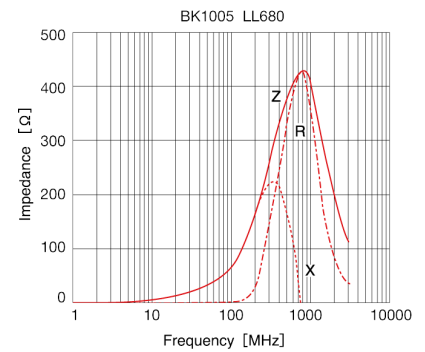

The data is reference only. Electrical characteristics vary depending on environment or measurement condition.  
 TAIYO YUDEN reserves the right to make change to the Date at any time without notice.  
 Before making final selection, please check product specification.