

**LOW SENSITIVITY MICROPOWER  
OMNIPOLAR HALL-EFFECT SWITCH**
**Description**

The AH1809 is a low sensitivity micro power Omnipolar Hall Effect switch IC designed for battery powered consumer to home appliance and industrial equipment such smart e-meters. Based on two Hall Effect plates and a chopper stabilized architecture the AH1809 provides a reliable solution over the whole operating range. To support battery and low power applications the design has been optimized to operate over the supply range of 2.5V to 5.5V and consumes only 24 $\mu$ W with a supply of 3V.

The single open drain output can be switched on with either a North or South pole of sufficient strength. When the magnetic flux density perpendicular to the package (B) is larger than operate point (Bop) the output is switched on (pulled low). The output is turned off when B becomes lower than the release point (Brp). The output will remain off when there is no magnetic field.

The AH1809 is available in SOT553 and SIP-3L.

**Features**

- Omnipolar (North or South pole) Operation
- Low Sensitivity
- Single Open Drain Output
- Micropower Operation
- 2.5V to 5.5V Operating Range
- Chopper Stabilized Design Provides
  - Superior Temperature Stability
  - Minimal Switch Point Drift
  - Enhanced Immunity to Stress
- Good RF Noise Immunity
- -40°C to +125°C Operating Temperature
- High ESD
- Small Low Profile SOT553 and Industry Standard SIP-3L Packages
- **Totally Lead-Free & Fully RoHS Compliant (Notes 1 & 2)**
- **Halogen and Antimony Free. "Green" Device (Note 3)**

Notes: 1. No purposely added lead. Fully EU Directive 2002/95/EC (RoHS) & 2011/65/EU (RoHS 2) compliant.  
 2. See <http://www.diodes.com> for more information about Diodes Incorporated's definitions of Halogen- and Antimony-free, "Green" and Lead-free.  
 3. Halogen- and Antimony-free "Green" products are defined as those which contain <900ppm bromine, <900ppm chlorine (<1500ppm total Br + Cl) and <1000ppm antimony compounds.

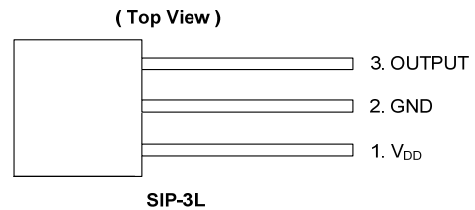
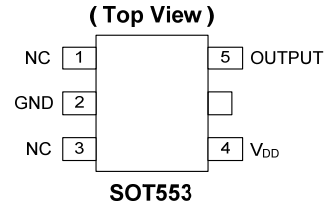
**Pin Assignments**

**Applications**

- Smart E-Meters
- Tamper Protection Switch
- Door, Lids and Tray Position Switch
- Proximity and Position Switches
- Level Detects
- On/Off Switch Digital Contact-Less Switch in Industrial and Consumer Products

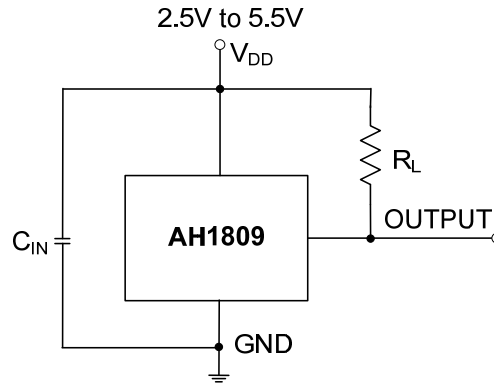
## Typical Applications Circuit



Note: 4.  $C_{IN}$  is for power stabilization and to strengthen the noise immunity, the recommended capacitance is 10nF ~ 100nF.  
 $R_L$  is the pull-up resistor, the recommended resistance is 10k $\Omega$  to 100k $\Omega$ .

## Pin Descriptions

Package: SIP-3L

Pin Number	Pin Name	Function
1	V <sub>DD</sub>	Power Supply Input
2	GND	Ground
3	OUTPUT	Output Pin

Package: SOT553

Pin Number	Pin Name	Function
1	NC	No Connection (Note 5)
2	GND	Ground
3	NC	No Connection (Note 5)
4	V <sub>DD</sub>	Power Supply Input
5	OUTPUT	Output

Note: 5. NC is "No Connection" pin and is not connected internally. This pin can be left open or tied to ground.

## Functional Block Diagram

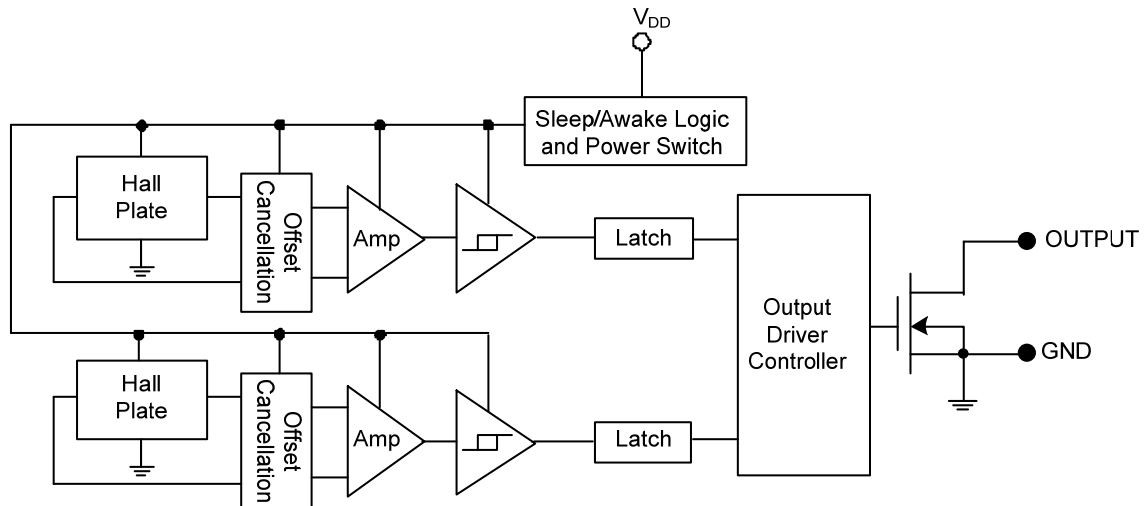

**Absolute Maximum Ratings** (Note 6) (@T<sub>A</sub> = +25°C, unless otherwise specified.)

Symbol	Parameter	Rating	Unit	
V <sub>DD</sub>	Supply Voltage (Note 7)	7	V	
V <sub>DD REV</sub>	Reverse Supply Voltage	-0.3	V	
I <sub>OUTPUT</sub>	Output current (source and sink)	2.5	mA	
B	Magnetic Flux Density	Unlimited		
P <sub>D</sub>	Package Power Dissipation	SOT553	230	mW
		SIP-3L	230	
T <sub>s</sub>	Storage Temperature Range	-65 to +150	°C	
T <sub>J</sub>	Maximum Junction Temperature	150	°C	
ESD HBM	Human Body Model ESD capability	6	kV	

- Notes:
- Stresses greater than the 'Absolute Maximum Ratings' specified above may cause permanent damage to the device. These are stress ratings only; functional operation of the device at these or any other conditions exceeding those indicated in this specification is not implied. Device reliability may be affected by exposure to absolute maximum rating conditions for extended periods of time.
  - The absolute maximum V<sub>DD</sub> of 7V is a transient stress rating and is not meant as a functional operating condition. It is not recommended to operate the device at the absolute maximum rated conditions for any period of time.

**Recommended Operating Conditions** (@T<sub>A</sub> = +25°C, unless otherwise specified.)

Symbol	Parameter	Conditions	Rating	Unit
V <sub>DD</sub>	Supply Voltage	Operating	2.5 to 5.5	V
T <sub>A</sub>	Operating Temperature Range	Operating	-40 to +125	°C

**Electrical Characteristics** (@T<sub>A</sub> = +25°C, V<sub>DD</sub> = 3V, unless otherwise specified.)

Symbol	Parameter	Conditions	Min	Typ	Max	Unit
V <sub>OUT</sub>	Output On Voltage	I <sub>OUT</sub> = 1mA	—	0.1	0.3	V
I <sub>off</sub>	Output Leakage Current	V <sub>OUT</sub> = 3.6V, Output off	—	< 0.1	1	µA
I <sub>DD(awake)</sub>	Supply Current	During 'awake' period, T <sub>A</sub> = +25°C, V <sub>DD</sub> = 3V	—	3	6	mA
		During 'awake' period, T <sub>A</sub> = -40 to +125°C, V <sub>DD</sub> = 2.5V to 5.5V	—	—	12	mA
I <sub>DD(sleep)</sub>	Supply Current	During 'sleep' period, T <sub>A</sub> = +25°C, V <sub>DD</sub> = 3V	—	5	10	µA
I <sub>DD(sleep)</sub>		During 'sleep' period, T <sub>A</sub> = -40 to +125°C, V <sub>DD</sub> = 2.5V to 5.5V	—	—	28	µA
I <sub>DD(avg)</sub>	Average Supply Current	T <sub>A</sub> = +25°C, V <sub>DD</sub> = 3V	—	8	16	µA
		T <sub>A</sub> = -40 to +125°C, V <sub>DD</sub> = 2.5V to 5.5V	—	—	40	µA
T <sub>awake</sub>	Awake Time	(Note 8)	—	75	125	µs
T <sub>period</sub>	Period	(Note 8)	—	75	125	ms
D.C.	Duty Cycle		—	0.1	—	%

- Notes:
- When power is initially turned on, the operating V<sub>DD</sub> must be within its correct operating range (2.5V to 3.6V) to guaranteed the output sampling. The output state is valid after the second operating cycle (typical 150ms).

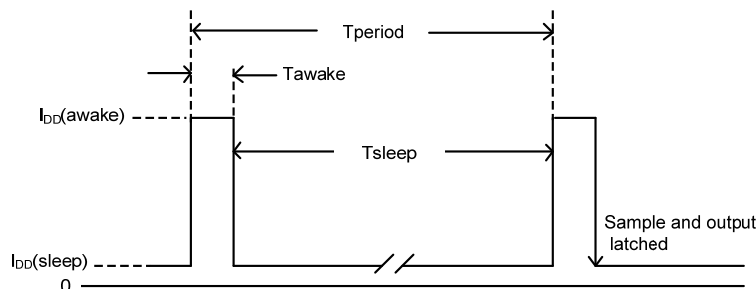

**Magnetic Characteristics** (Note 9 & 10) ( $T_A = +25^\circ\text{C}$ ,  $V_{DD} = 2.5\text{V to } 5.5\text{V}$ , unless otherwise specified)

(1mT=10 Gauss)

Symbol	Characteristics	Test Condition	Min	Typ	Max	Unit
Bops (south pole to part marking side)	Operation Point	$T_A = +25^\circ\text{C}$	100	130	165	Gauss
Bopn (north pole to part marking side)		$T_A = -40^\circ\text{C to } +125^\circ\text{C}$	90	130	185	
Brps (south pole to part marking side)		$T_A = +25^\circ\text{C}$	-165	-130	-100	
		$T_A = -40^\circ\text{C to } +125^\circ\text{C}$	-185	-130	-90	
Brpn (north pole to part marking side)	Release Point	$T_A = +25^\circ\text{C}$	90	115	150	
		$T_A = -40^\circ\text{C to } +125^\circ\text{C}$	80	115	170	
Bhy ( $ B_{opx}  -  B_{rpx} $ )		$T_A = +25^\circ\text{C}$	-150	-115	-90	
		$T_A = -40^\circ\text{C to } +125^\circ\text{C}$	-170	-115	-80	
Bhy ( $ B_{opx}  -  B_{rpx} $ )	Hysteresis (Note 11)	$T_A = +25^\circ\text{C}$	10	15	20	
		$T_A = -40^\circ\text{C to } +125^\circ\text{C}$	5	15	—	

- Notes:
- Typical data is at  $T_A = +25^\circ\text{C}$ ,  $V_{DD} = 3\text{V}$ .
  - Parameters values over operating temperature range are not tested in production, they are guaranteed by design, process control and characterization. The magnetic characteristics may vary with supply voltage, operating temperature and after soldering.
  - Maximum and minimum hysteresis is guaranteed by design and characterization.

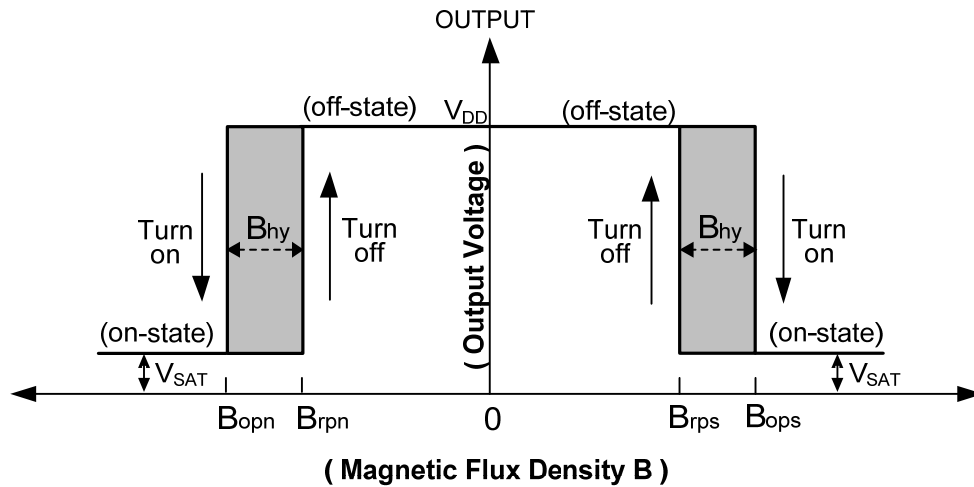

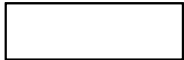

**Typical Operating Characteristics**

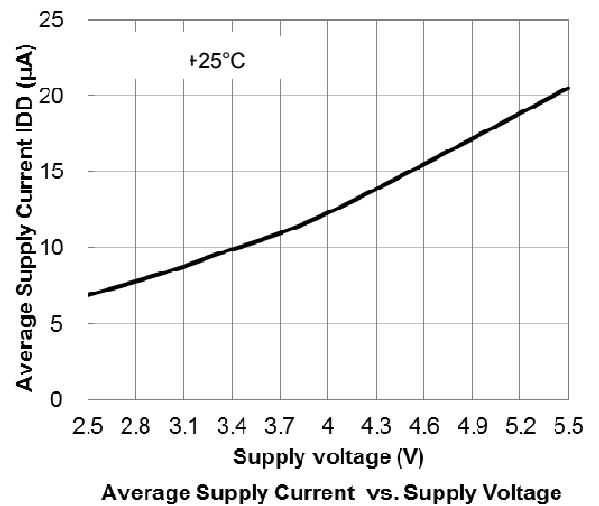
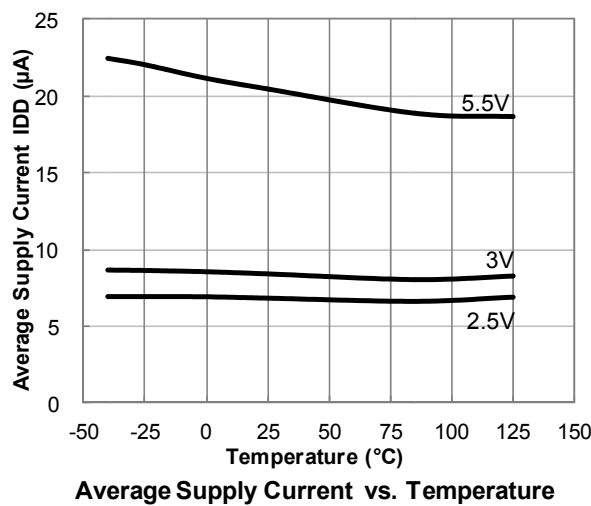
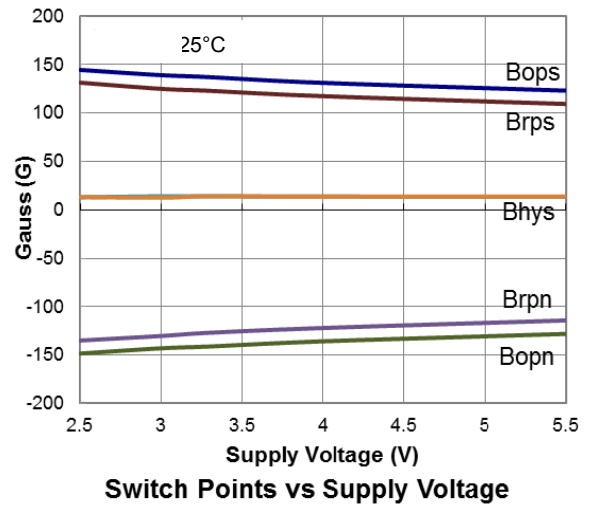
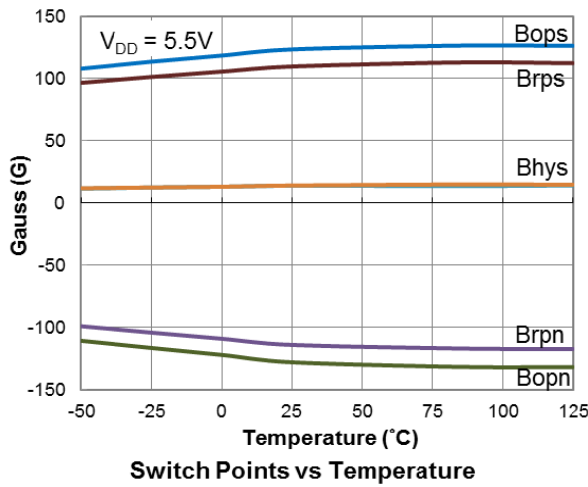
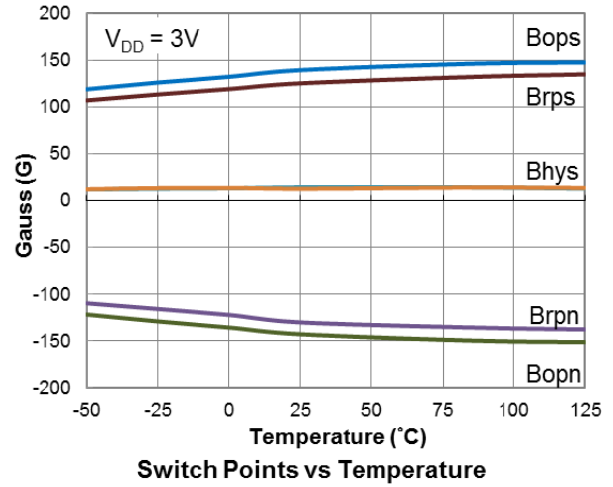
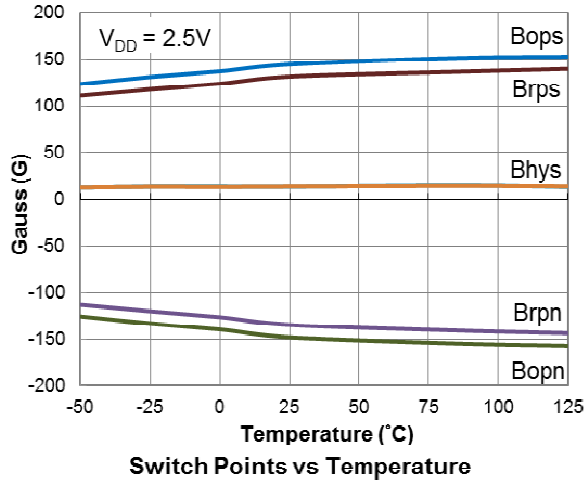

**Thermal Performance Characteristics**

(1) Package type: SOT553 and SIP-3L

T <sub>A</sub> (°C)	25	50	60	70	80	85	90	100	110	120	130	140	150
P <sub>D</sub> (mW)	230	184	166	147	129	120	110	92	74	55	37	18	0

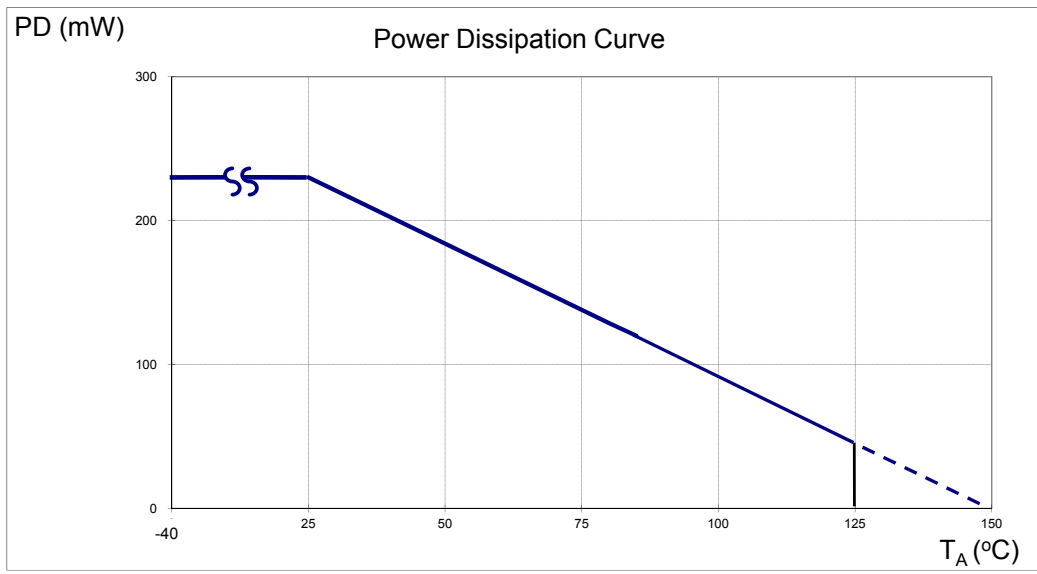

**Ordering Information**

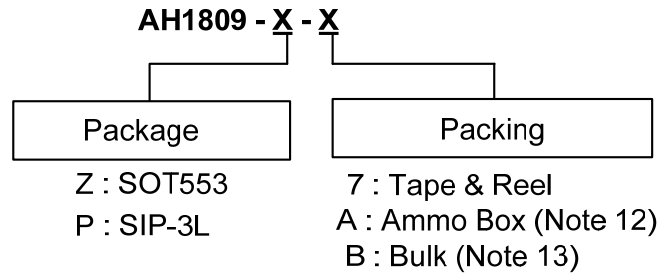

Part Number	Package Code	Packaging	Bulk		7" Tape and Reel		Ammo Box	
			Quantity	Part Number Suffix	Quantity	Part Number Suffix	Quantity	Part Number Suffix
AH1809-Z-7	Z	SOT553	NA	NA	3000/Tape & Reel	-7	NA	NA
AH1809-P-B	P	SIP-3L	1000	-B	NA	NA	NA	NA
AH1809-P-A	P	SIP-3L	NA	NA	NA	NA	-A	4000/Box

Notes: 12. Ammo Box is for SIP-3L Spread Lead.  
13. Bulk is for SIP-3L Straight Lead.

**Marking Information**

(1) Package Type: SOT553

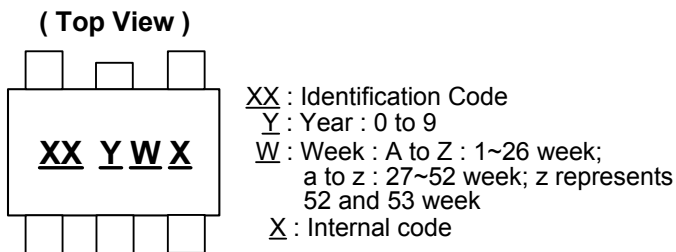

Part Number	Package	Identification Code
AH1809	SOT553	H9

(2) Package Type: SIP-3L

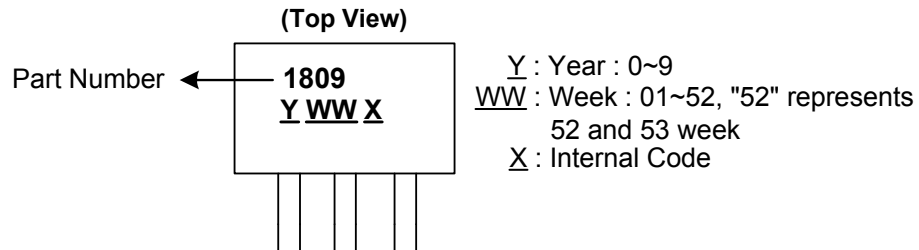

**Package Outline Dimensions** (All dimensions in mm.)

Please see AP02002 at <http://www.diodes.com/datasheets/ap02002.pdf> for latest version.

**(1) Package Type: SOT553**

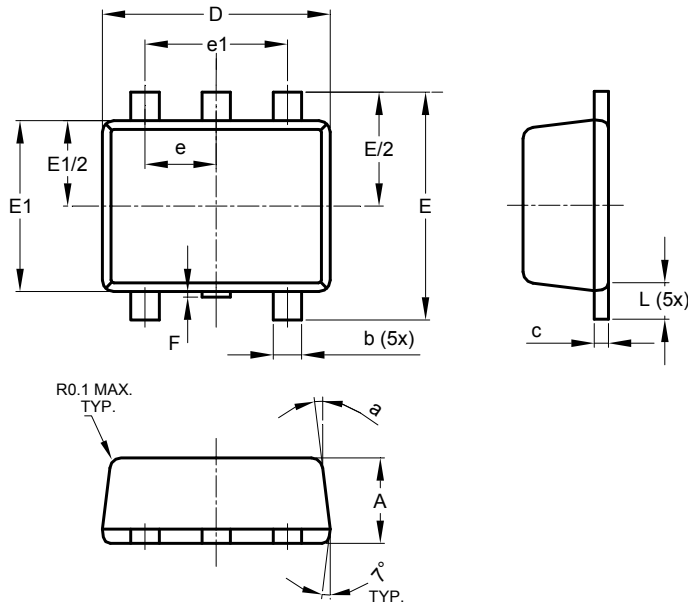

SOT553			
Dim	Min	Max	Typ
A	0.55	0.62	0.60
b	0.15	0.30	0.20
c	0.10	0.18	0.15
D	1.50	1.70	1.60
E	1.55	1.70	1.60
E1	1.10	1.25	1.20
e	0.50 BSC		
e1	1.00 BSC		
F	0.00	0.10	—
L	0.10	0.30	0.20
a	6°	8°	7°
All Dimensions in mm			

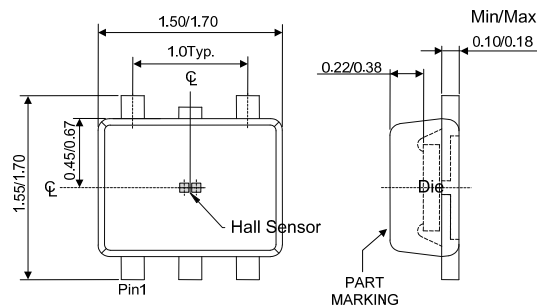

**Sensor location**



**Package Outline Dimensions** (cont.) (All dimensions in mm.)

(2) Package Type: SIP-3L for Bulk pack

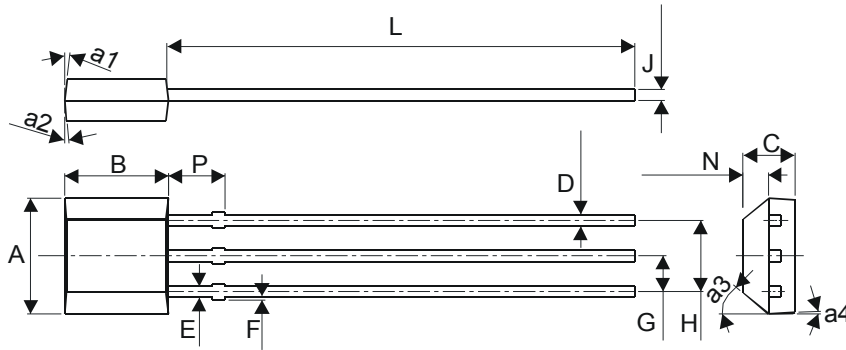

SIP-3 for Bulk Pack		
Dim	Min	Max
A	3.9	4.3
a1	5° Typ	
a2	5° Typ	
a3	45° Typ	
a4	3° Typ	
B	2.8	3.2
C	1.40	1.60
D	0.33	0.432
E	0.40	0.508
F	0	0.2
G	1.24	1.30
H	2.51	2.57
J	0.35	0.43
L	14.0	15.0
N	0.63	0.84
P	1.55	-
All Dimensions in mm		

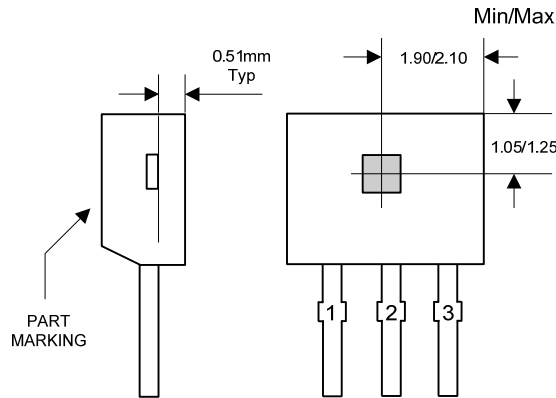

**Sensor Location**

**Package Outline Dimensions** (cont.) (All dimensions in mm.)

**(3) Package Type: SIP-3L for Ammo Pack**

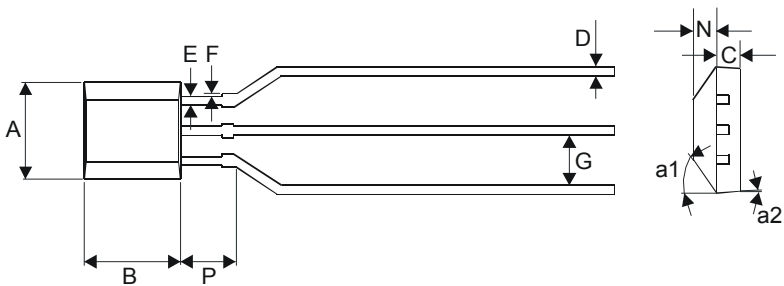

SIP-3 for Ammo Pack only		
Dim	Min	Max
A	3.9	4.3
a1	45° Typ	
a2	3° Typ	
B	2.8	3.2
C	1.40	1.60
D	0.35	0.41
E	0.43	0.48
F	0	0.2
G	2.4	2.9
N	0.63	0.84
P	1.55	-
<b>All Dimensions in mm</b>		

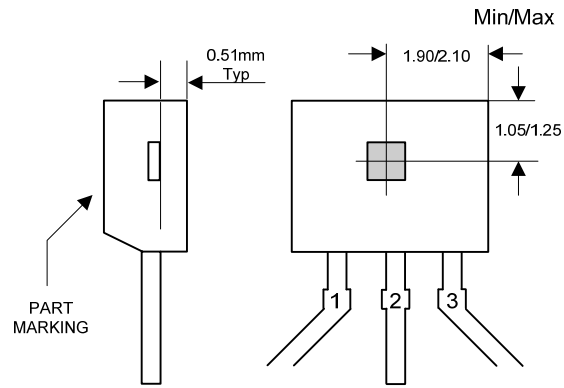

**Sensor Location**

**Suggested Pad Layout**

Please see AP02001 at <http://www.diodes.com/datasheets/ap02001.pdf> for the latest version.

**(1) Package Type: SOT553**

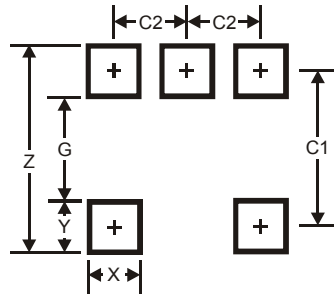

Dimensions	Value (in mm)
Z	2.2
G	1.2
X	0.375
Y	0.5
C1	1.7
C2	0.5

**IMPORTANT NOTICE**

DIODES INCORPORATED MAKES NO WARRANTY OF ANY KIND, EXPRESS OR IMPLIED, WITH REGARDS TO THIS DOCUMENT, INCLUDING, BUT NOT LIMITED TO, THE IMPLIED WARRANTIES OF MERCHANTABILITY AND FITNESS FOR A PARTICULAR PURPOSE (AND THEIR EQUIVALENTS UNDER THE LAWS OF ANY JURISDICTION).

Diodes Incorporated and its subsidiaries reserve the right to make modifications, enhancements, improvements, corrections or other changes without further notice to this document and any product described herein. Diodes Incorporated does not assume any liability arising out of the application or use of this document or any product described herein; neither does Diodes Incorporated convey any license under its patent or trademark rights, nor the rights of others. Any Customer or user of this document or products described herein in such applications shall assume all risks of such use and will agree to hold Diodes Incorporated and all the companies whose products are represented on Diodes Incorporated website, harmless against all damages.

Diodes Incorporated does not warrant or accept any liability whatsoever in respect of any products purchased through unauthorized sales channel. Should Customers purchase or use Diodes Incorporated products for any unintended or unauthorized application, Customers shall indemnify and hold Diodes Incorporated and its representatives harmless against all claims, damages, expenses, and attorney fees arising out of, directly or indirectly, any claim of personal injury or death associated with such unintended or unauthorized application.

Products described herein may be covered by one or more United States, international or foreign patents pending. Product names and markings noted herein may also be covered by one or more United States, international or foreign trademarks.

This document is written in English but may be translated into multiple languages for reference. Only the English version of this document is the final and determinative format released by Diodes Incorporated.

**LIFE SUPPORT**

Diodes Incorporated products are specifically not authorized for use as critical components in life support devices or systems without the express written approval of the Chief Executive Officer of Diodes Incorporated. As used herein:

A. Life support devices or systems are devices or systems which:

1. are intended to implant into the body, or
2. support or sustain life and whose failure to perform when properly used in accordance with instructions for use provided in the labeling can be reasonably expected to result in significant injury to the user.

B. A critical component is any component in a life support device or system whose failure to perform can be reasonably expected to cause the failure of the life support device or to affect its safety or effectiveness.

Customers represent that they have all necessary expertise in the safety and regulatory ramifications of their life support devices or systems, and acknowledge and agree that they are solely responsible for all legal, regulatory and safety-related requirements concerning their products and any use of Diodes Incorporated products in such safety-critical, life support devices or systems, notwithstanding any devices- or systems-related information or support that may be provided by Diodes Incorporated. Further, Customers must fully indemnify Diodes Incorporated and its representatives against any damages arising out of the use of Diodes Incorporated products in such safety-critical, life support devices or systems.

Copyright © 2012, Diodes Incorporated

[www.diodes.com](http://www.diodes.com)