

# 1.5A Synchronous Boost LED Flash Driver w/ High-Side Current Source

Check for Samples: [LM3556](#)

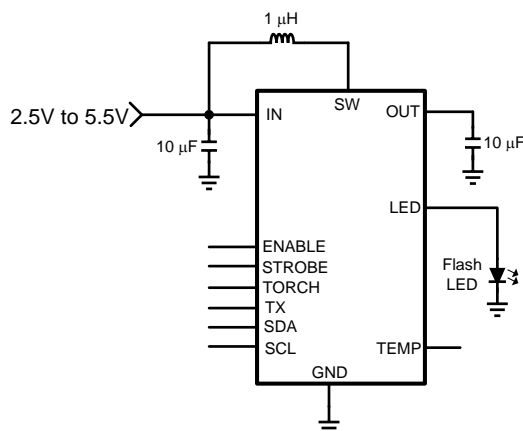
## FEATURES

- Grounded Cathode LED Operation for Improved Thermal Management
- 1.5A High-Side Current Source for Single LED
- Accurate and Programmable LED Current from 46.9 mA to 1.5A
- > 85% Efficiency in Torch Mode (@ 100 mA) and Flash Mode (@ 1A to 1.5A)
- Small Solution Size: < 20 mm<sup>2</sup>
- LED Thermal Sensing and Current Scale-Back
- Soft-Start Operation for Battery Protection
- Hardware Enable Pin
- Hardware Torch Enable
- Hardware Strobe Enable
- Synchronization Input for RF Power Amplifier Pulse Events
- VIN Flash Monitor Optimization
- 400 kHz I<sup>2</sup>C-Compatible Interface
- I<sup>2</sup>C-Compatible Programmable NTC Trip Point
- 0.4 mm Pitch, 16-Bump DSBGA Package

## APPLICATIONS

- Camera Phone LED Flash

## TYPICAL APPLICATION CIRCUIT



## DESCRIPTION

The LM3556 is a 4 MHz fixed-frequency synchronous boost converter plus 1.5A constant current driver for a high-current white LED. The high-side current source allows for grounded cathode LED operation providing Flash current up to 1.5A. An adaptive regulation method ensures the current source remains in regulation and maximizes efficiency.

The LM3556 is controlled via an I<sup>2</sup>C-compatible interface. Features include: a hardware flash enable (STROBE) allowing a logic input to trigger the flash pulse, a hardware Torch enable (TORCH) for Movie Mode or Flashlight functions, a TX input which forces the flash pulse into a low-current Torch mode allowing for synchronization to RF power amplifier events or other high-current conditions, and an integrated comparator designed to monitor an NTC thermistor and provide an interrupt to the LED current. With a fast 1 µs transition from 0 mA to 46.9 mA, the Torch input pin can be used to develop custom LED current waveforms.

The 4 MHz switching frequency, over-voltage protection and adjustable current limit allow for the use of tiny, low-profile inductors and (10 µF) ceramic capacitors. The device is available in a small 16-bump (1.660 mm x 1.610 mm x 0.6 mm) DSBGA package and operates over the -40°C to +85°C temperature range.



Please be aware that an important notice concerning availability, standard warranty, and use in critical applications of Texas Instruments semiconductor products and disclaimers thereto appears at the end of this data sheet.

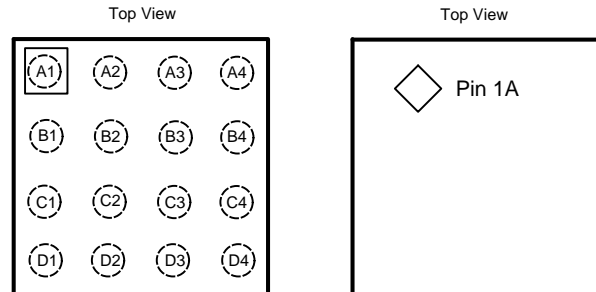
All trademarks are the property of their respective owners.



This integrated circuit can be damaged by ESD. Texas Instruments recommends that all integrated circuits be handled with appropriate precautions. Failure to observe proper handling and installation procedures can cause damage.

ESD damage can range from subtle performance degradation to complete device failure. Precision integrated circuits may be more susceptible to damage because very small parametric changes could cause the device not to meet its published specifications.

## CONNECTION DIAGRAM



**Figure 1. 16-Bump DSBGA Package YFQ16ACA**

### PIN DESCRIPTIONS

Pin	Name	Description
A1, B1	LED	High-Side Current Source Output for Flash LED. Both bumps must be connected for proper operation.
B2, A2	OUT	Step-Up DC/DC Converter Output. Connect a 10 $\mu$ F ceramic capacitor between this pin and GND.
B3, A3	SW	Drain Connection for Internal NMOS and Synchronous PMOS Switches.
A4, B4	GND	Ground
C1	TEMP	Threshold Detector for LED Temperature Sensing and Current Scale Back.
C2	TORCH	Active High Hardware Torch Enable. Drive TORCH high to turn on Torch/Movie Mode. Used for External PWM mode. Has an internal pulldown resistor of 300 k $\Omega$ between TORCH and GND.
C3	STROBE	Active High Hardware Flash Enable. Drive STROBE high to turn on Flash pulse. STROBE overrides TORCH. Has an internal pulldown resistor of 300 k $\Omega$ between STROBE and GND.
C4	IN	Input Voltage Connection. Connect IN to the input supply, and bypass to GND with a 10 $\mu$ F or larger ceramic capacitor.
D1	TX	Configurable Dual Polarity Power Amplifier Synchronization Input. Has an internal pulldown resistor of 300 k $\Omega$ between TX and GND.
D2	SDA	Serial Data Input/Output.
D3	SCL	Serial Clock Input.
D4	ENABLE	Active High Enable Pin. High = Standby, Low = Shutdown/Reset. There is no internal pulldown resistor on this pin.

TYPICAL LAYOUT

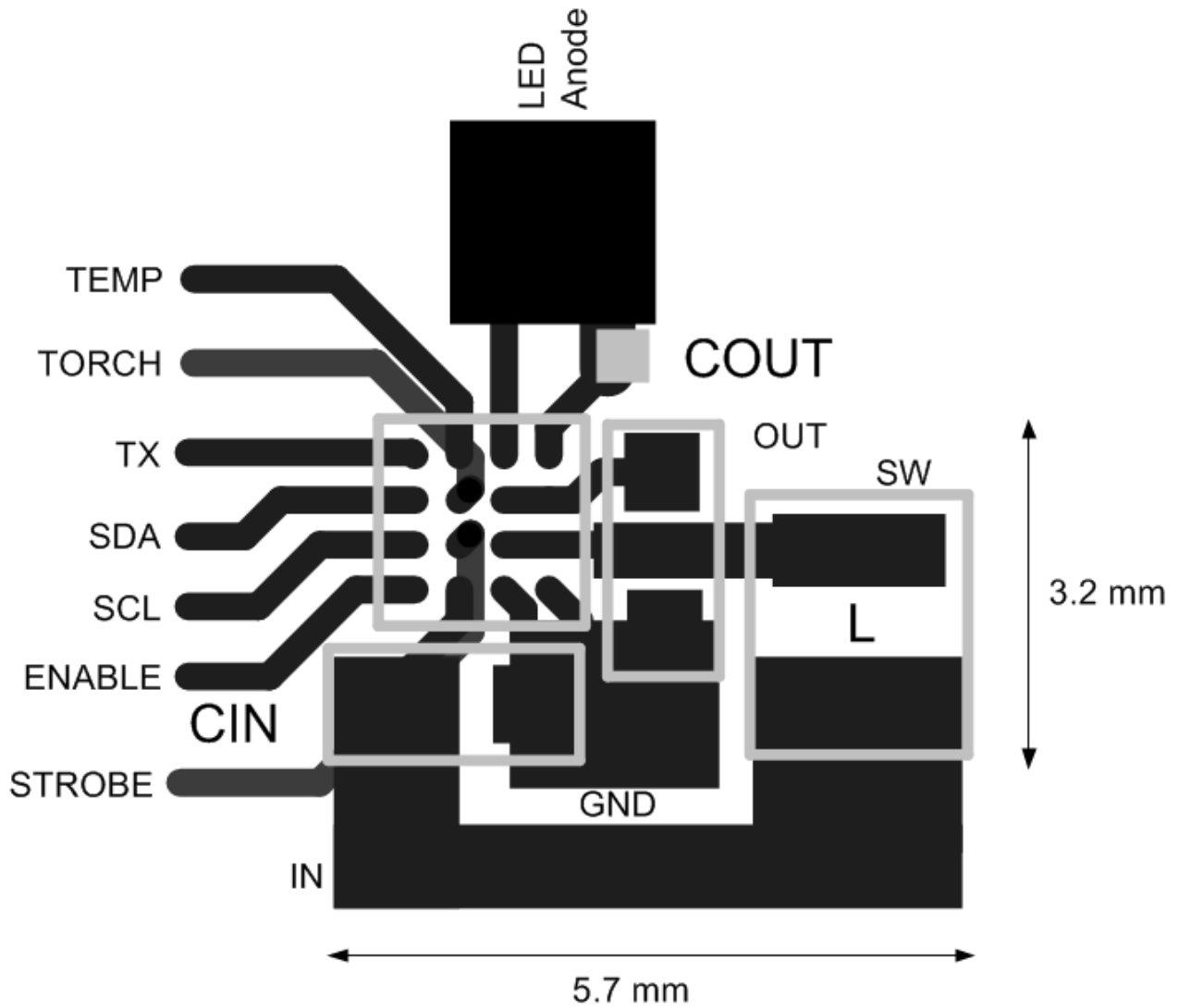


Table 1. Application Circuit Component List

Component	Manufacturer	Value	Part-Number	Size (mm)	Current/Voltage Rating (Resistance)
L	TOKO	1µH	FDSD0312-1R0	3 mm x 3 mm x 1.2 mm	3.4A
COUT	Murata	10 µF	GRM188R60J106M	1.6 mm x 0.8 mm x 0.8 mm (0603)	6.3V
CIN	Murata	10 µF	GRM188R60J106M	1.6 mm x 0.8 mm x 0.8 mm (0603)	6.3V
LED	Lumiled		PWF-4		VF = 3.6V, @1.5A

FUNCTIONAL BLOCK DIAGRAM

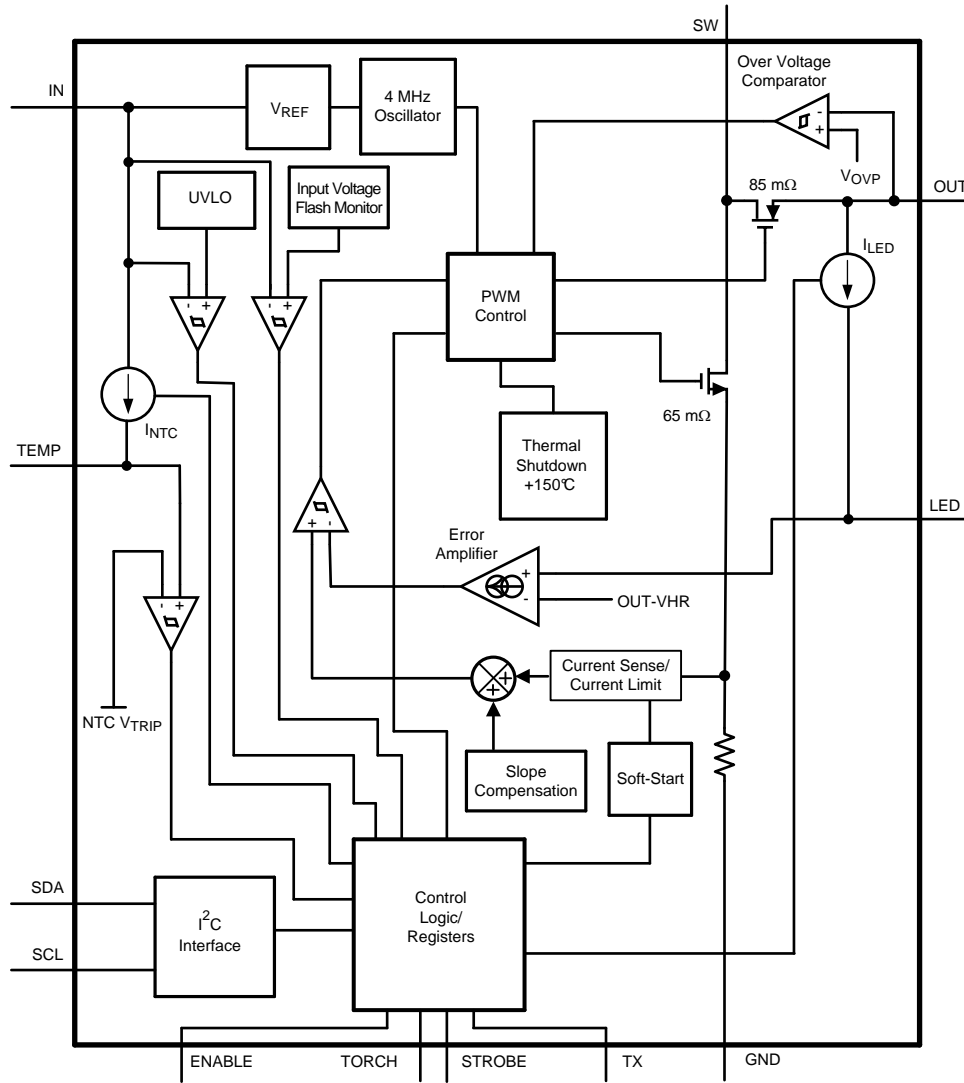


Figure 2. Block Diagram

**ABSOLUTE MAXIMUM RATINGS** (1) (2)

$V_{IN}$ , $V_{SW}$ , $V_{OUT}$	-0.3V to 6V
$V_{SCL}$ , $V_{SDA}$ , $V_{ENABLE}$ , $V_{STROBE}$ , $V_{TX}$ , $V_{TORCH}$ , $V_{LED}$ , $V_{TEMP}$	-0.3V to the lesser of ( $V_{IN}+0.3V$ ) w/ 6V max
Continuous Power Dissipation (3)	Internally Limited
Junction Temperature ( $T_{J-MAX}$ )	+150°C
Storage Temperature Range	-65°C to +150°C
Maximum Lead Temperature (Soldering)	(4)

- (1) Stresses beyond those listed under *absolute maximum ratings* may cause permanent damage to the device. These are stress ratings only, and functional operation of the device at these or any other conditions beyond those indicated under *recommended operating conditions* is not implied. Exposure to absolute-maximum-rated conditions for extended periods may affect device reliability.
- (2) All voltages are with respect to the potential at the GND pin.
- (3) Internal thermal shutdown circuitry protects the device from permanent damage. Thermal shutdown engages at  $T_J = +150^\circ\text{C}$  (typ.) and disengages at  $T_J = +135^\circ\text{C}$  (typ.). Thermal shutdown is guaranteed by design.
- (4) For detailed soldering specifications and information, please refer to Texas Instruments Application Note 1112: DSBGA Wafer Level chip Scale Package (AN-1112)

**OPERATING RATINGS** (1) (2)

$V_{IN}$	2.5V to 5.5V
Junction Temperature ( $T_J$ )	-40°C to +125°C
Ambient Temperature ( $T_A$ ) (3)	-40°C to +85°C

- (1) Stresses beyond those listed under *absolute maximum ratings* may cause permanent damage to the device. These are stress ratings only, and functional operation of the device at these or any other conditions beyond those indicated under *recommended operating conditions* is not implied. Exposure to absolute-maximum-rated conditions for extended periods may affect device reliability.
- (2) All voltages are with respect to the potential at the GND pin.
- (3) In applications where high power dissipation and/or poor package thermal resistance is present, the maximum ambient temperature may have to be derated. Maximum ambient temperature ( $T_{A-MAX}$ ) is dependent on the maximum operating junction temperature ( $T_{J-MAX-OP} = +125^\circ\text{C}$ ), the maximum power dissipation of the device in the application ( $P_{D-MAX}$ ), and the junction-to-ambient thermal resistance of the part/package in the application ( $\theta_{JA}$ ), as given by the following equation:  $T_{A-MAX} = T_{J-MAX-OP} - (\theta_{JA} \times P_{D-MAX})$ .

**THERMAL PROPERTIES**

Thermal Junction-to-Ambient Resistance ( $\theta_{JA}$ ) (1)	60°C/W
--	--------

- (1) Junction-to-ambient thermal resistance ( $\theta_{JA}$ ) is taken from a thermal modeling result, performed under the conditions and guidelines set forth in the JEDEC standard JESD51-7. The test board is a 4-layer FR-4 board measuring 102 mm x 76 mm x 1.6 mm with a 2x1 array of thermal vias. The ground plane on the board is 50 mm x 50 mm. Thickness of copper layers are 36  $\mu\text{m}$ /18  $\mu\text{m}$ /18  $\mu\text{m}$ /36  $\mu\text{m}$  (1.5 oz/1oz/1oz/1.5 oz). Ambient temperature in simulation is 22°C, still air. Power dissipation is 1W.

**ELECTRICAL CHARACTERISTICS** (1) (2)

Limits in standard typeface are for  $T_A = +25^\circ\text{C}$ . Limits in **boldface** type apply over the full operating ambient temperature range ( $-40^\circ\text{C} \leq T_A \leq +85^\circ\text{C}$ ). Unless otherwise specified,  $V_{IN} = 3.6\text{V}$ .

Symbol	Parameter	Conditions	Min	Typ	Max	Units
<b>Current Source Specifications</b>						
$I_{LED}$	Current Source Accuracy	1.5A Flash, $V_{OUT} = 4\text{V}$	<b>1.425</b> <b>(-5%)</b>	1.5	<b>1.575</b> <b>(+5%)</b>	A
		46.88 mA Torch, $V_{OUT} = 3.6\text{V}$	<b>42.3</b> <b>(-10%)</b>	47	<b>51.7</b> <b>(+10%)</b>	mA
$V_{HR}$	Current Source Regulation Voltage	$I_{LED} = 1.5\text{A}$		250	<b>280</b> <b>(+12%)</b>	mV
		$I_{LED} = 46.88\text{ mA}$		150	<b>172.5</b> <b>(+15%)</b>	
$V_{OVP}$	Output Over-Voltage Protection Trip Point	ON Threshold	<b>4.86</b>	5	<b>5.1</b>	V
		OFF Threshold	<b>4.75</b>	4.88	<b>4.99</b>	
<b>Step-Up DC/DC Converter Specifications</b>						
$R_{PMOS}$	PMOS Switch On-Resistance	$I_{PMOS} = 1\text{A}$		85		m $\Omega$
$R_{NMOS}$	NMOS Switch On-Resistance	$I_{NMOS} = 1\text{A}$		65		
$I_{CL}$	Switch Current Limit		<b>-12%</b>	1.7	<b>+12%</b>	A
			<b>-12%</b>	1.9	<b>+12%</b>	
			<b>-10%</b>	2.5	<b>+10%</b>	
			<b>-12%</b>	3.1	<b>+12%</b>	
$V_{TRIP}$	NTC Comparator Trip Threshold	Configuration Register, bit [1] = 1	<b>-6%</b>	600	<b>+6%</b>	mV
$UVLO$	Under Voltage Lockout Threshold	Falling $V_{IN}$	<b>2.74</b>	2.8	<b>2.85</b>	V
$I_{NTC}$	NTC Current		<b>-6%</b>	75	<b>+6%</b>	$\mu\text{A}$
$V_{IVFM}$	Input Voltage Flash Monitor trip threshold		<b>-3.2%</b>	2.9	<b>+3.2%</b>	V
$f_{SW}$	Switching Frequency	$2.5\text{V} \leq V_{IN} \leq 5.5\text{V}$	<b>3.72</b>	4	<b>4.28</b>	MHz
$I_Q$	Quiescent Supply Current	Device Not Switching Pass Mode		0.6	<b>0.75</b>	mA
$I_{SD}$	Shutdown Supply Current	Device Disabled, $EN = 0\text{V}$ $2.5\text{V} \leq V_{IN} \leq 5.5\text{V}$		0.1	<b>1.3</b>	$\mu\text{A}$
$I_{SB}$	Standby Supply Current	Device Disabled, $EN = 2\text{V}$ $2.5\text{V} \leq V_{IN} \leq 5.5\text{V}$		2.5	<b>4</b>	$\mu\text{A}$
$t_{TX}$	Flash-to-Torch LED Current Settling Time	TX Low to High, $I_{LED} = 1.5\text{A}$ to $46.88\text{ mA}$		4		$\mu\text{s}$
$I_{OS}$	ILED Overshoot in External Indicator Mode	0 mA to $I_{TORCH}$		8		%
<b>ENABLE, STROBE, TORCH, TX Voltage Specifications</b>						
$V_{IL}$	Input Logic Low	$2.5\text{V} \leq V_{IN} \leq 5.5\text{V}$	<b>0</b>		<b>0.4</b>	V
$V_{IH}$	Input Logic High		<b>1.2</b>		<b><math>V_{IN}</math></b>	
<b>I<sup>2</sup>C-Compatible Interface Specifications (SCL, SDA)</b>						
$V_{IL}$	Input Logic Low	$2.5\text{V} \leq V_{IN} \leq 4.2\text{V}$	<b>0</b>		<b>0.4</b>	V
$V_{IH}$	Input Logic High		<b>1.2</b>		<b><math>V_{IN}</math></b>	
$V_{OL}$	Output Logic Low	$I_{LOAD} = 3\text{ mA}$			<b>400</b>	mV
$t_1$	SCL Clock Frequency		<b>2.4</b>			$\mu\text{s}$
$t_2$	Data In Setup Time to SCL High		<b>100</b>			ns
$t_3$	Data Out Stable After SCL Low		<b>0</b>			
$t_4$	SDA Low Setup Time to SCL Low (Start)		<b>100</b>			
$t_5$	SDA High Hold Time After SCL High (Stop)		<b>100</b>			

(1) All voltages are with respect to the potential at the GND pin.

(2) Min and Max limits are specified by design, test, or statistical analysis. Typical (typ.) numbers are not verified, but do represent the most likely norm. Unless otherwise specified, conditions for typical specifications are:  $V_{IN} = 3.6\text{V}$  and  $T_A = +25^\circ\text{C}$ .

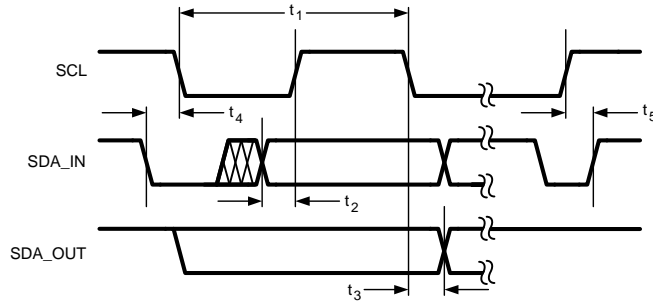


Figure 3. I<sup>2</sup>C-Compatible Interface Specifications

TYPICAL PERFORMANCE CHARACTERISTICS

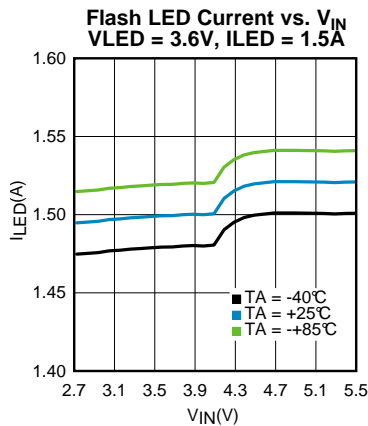


Figure 4.

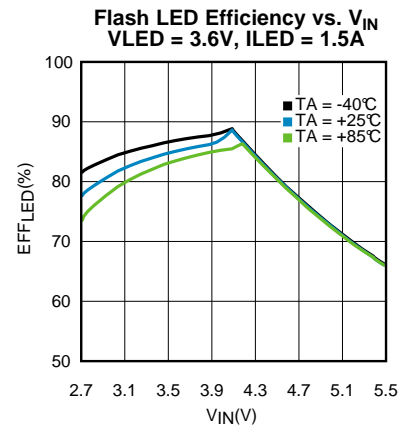


Figure 5.

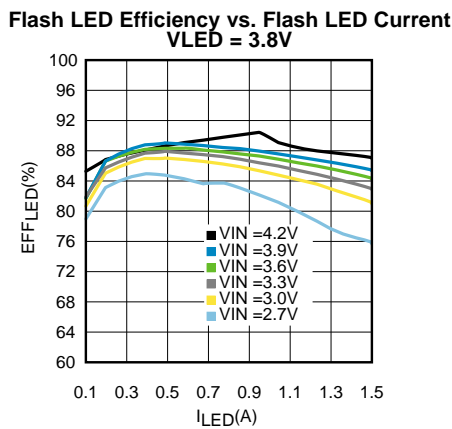


Figure 6.

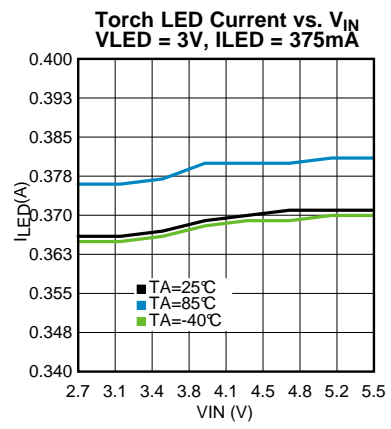


Figure 7.

**TYPICAL PERFORMANCE CHARACTERISTICS (continued)**

**Torch LED Efficiency vs.  $V_{IN}$**   
 $V_{LED} = 3V$

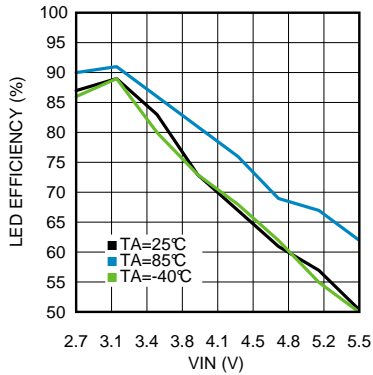


Figure 8.

**$I_q$  Standby vs.  $V_{IN}$**   
 $EN = 1.8V$

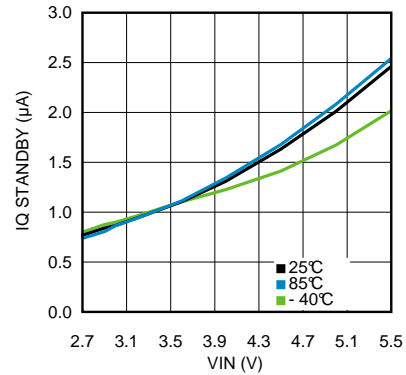


Figure 9.

**$I_q$  Shutdown vs.  $V_{IN}$**   
 $EN = 0V$

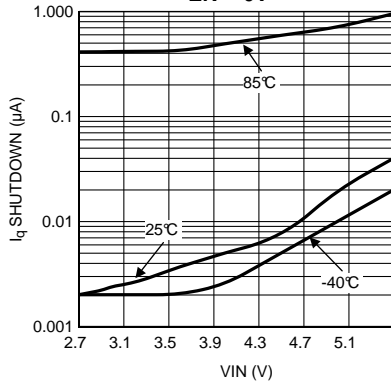


Figure 10.

**Variation of OVP with  $V_{IN}$**

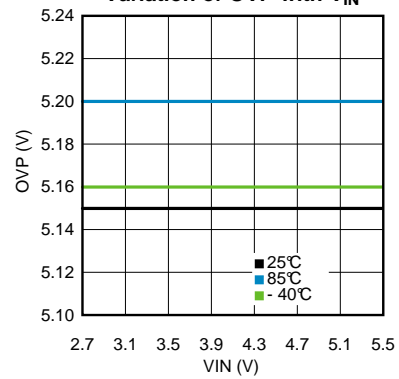


Figure 11.

**Frequency with  $V_{IN}$  and Over-Temperature**

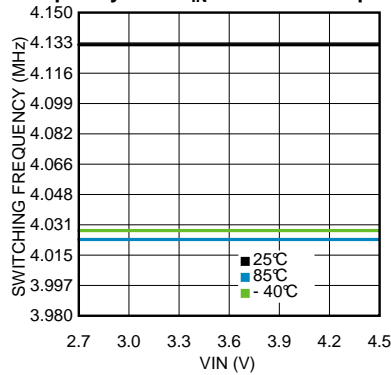


Figure 12.

**Input Current Limit Over-Temperature and  $V_{IN}$**   
Current Limit = 1.7A

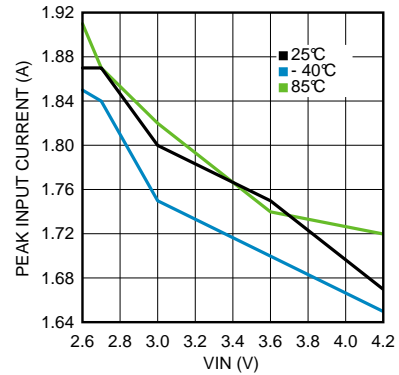


Figure 13.



**TYPICAL PERFORMANCE CHARACTERISTICS (continued)**

**Input Current Limit Over-Temperature and  $V_{IN}$  Current Limit = 1.9A**

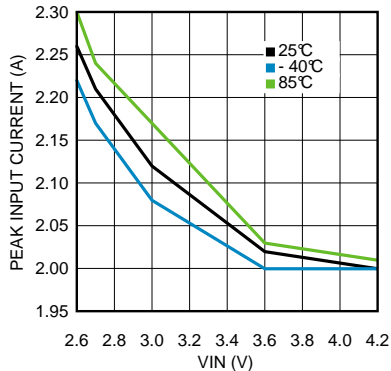


Figure 14.

**Input Current Limit Over-Temperature and  $V_{IN}$  Current Limit = 2.5A**

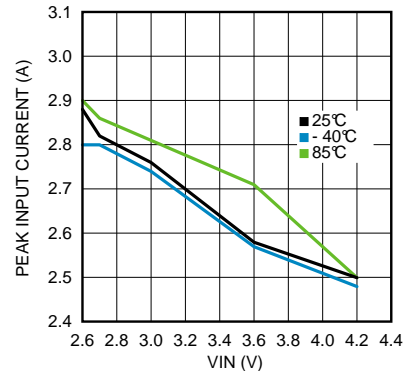


Figure 15.

**Input Current Limit Over-Temperature and  $V_{IN}$  Current Limit = 3.1A**

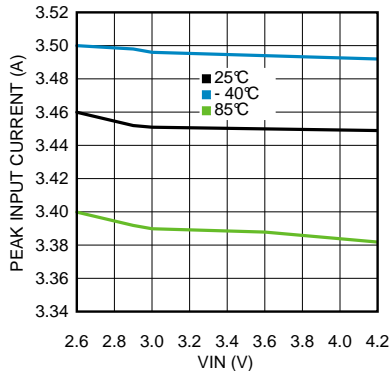


Figure 16.

**Startup Plot with part in Boost Mode Current Limit = 1.7A**

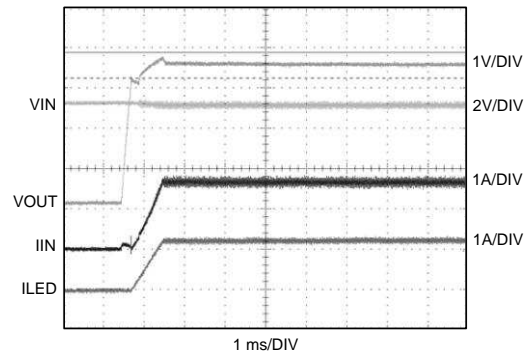


Figure 17.

**Strobe with Edge-Triggered Signal (400ms)**

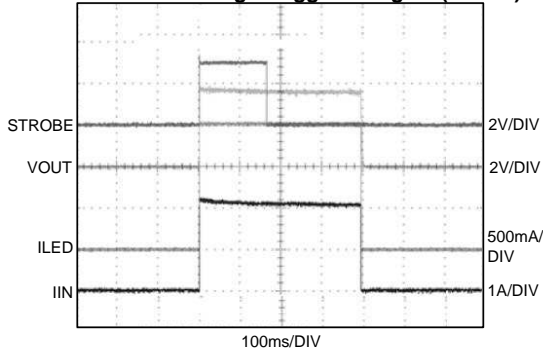


Figure 18.

**Strobe with Level-Triggered Signal (400ms)**

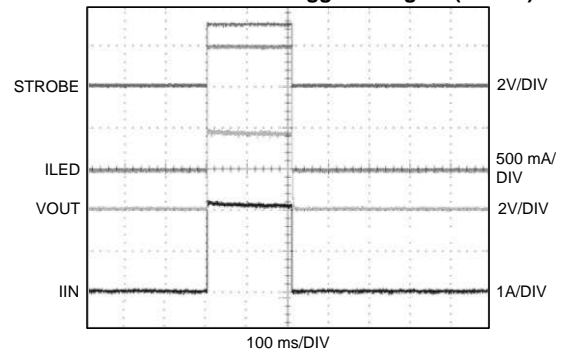
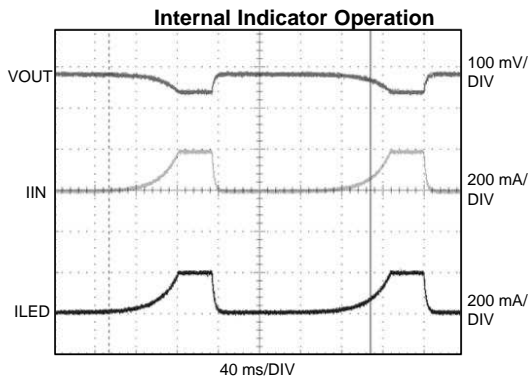
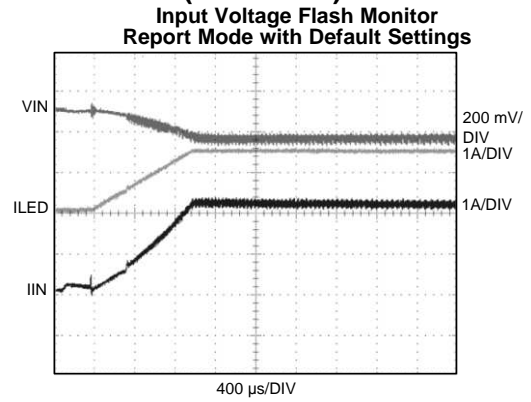


Figure 19.

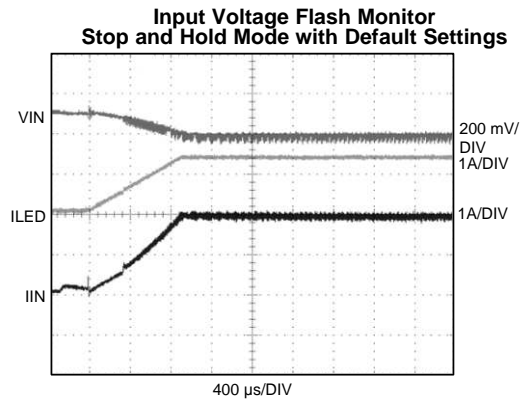
**TYPICAL PERFORMANCE CHARACTERISTICS (continued)**



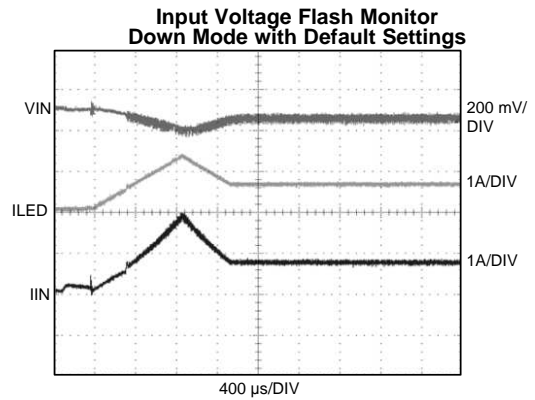
**Figure 20.**



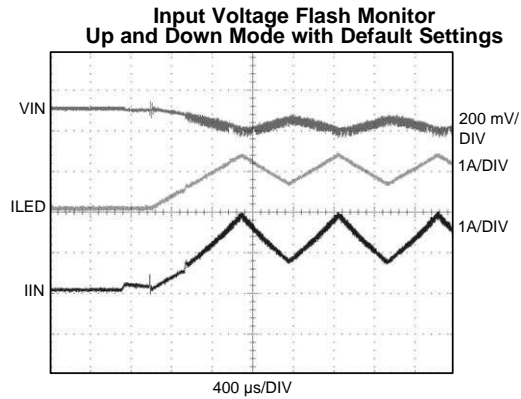
**Figure 21.**



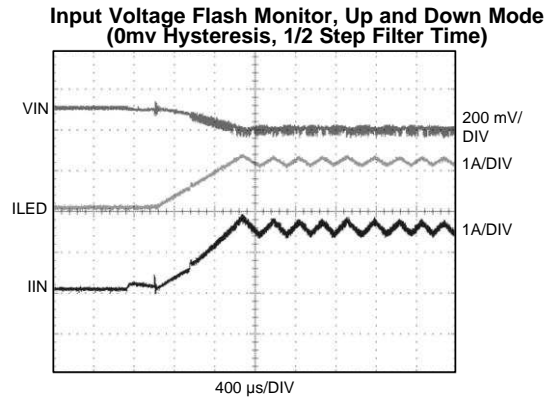
**Figure 22.**



**Figure 23.**



**Figure 24.**



**Figure 25.**

**TYPICAL PERFORMANCE CHARACTERISTICS (continued)**

**Input Voltage Flash Monitor, Up and Down Mode (0mV Hysteresis, 512  $\mu$ s Filter Time)**

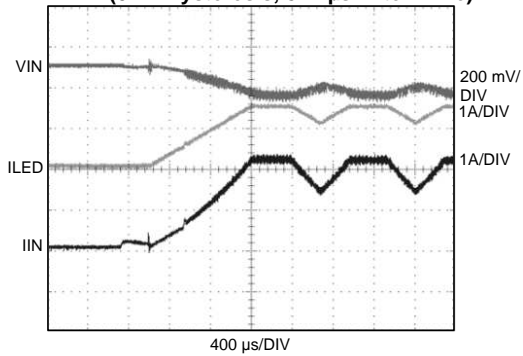


Figure 26.

**Input Voltage Flash Monitor, Up and Down Mode (256 $\mu$ s Flash Ramp, 1/2 Step Filter Time)**

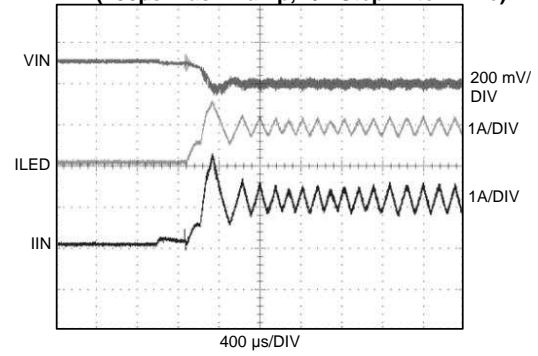


Figure 27.

**Impact on LED Current with a TX Event**

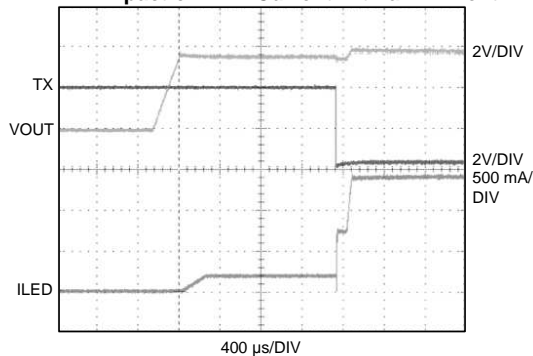


Figure 28.

**Time Taken for LM3556 to Ramp from Torch to Flash after TX Event**

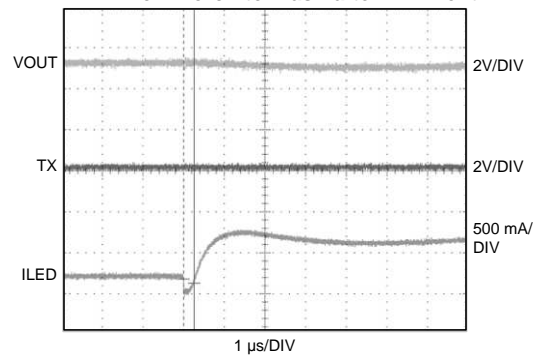


Figure 29.

**Transient Plot when VIN Stepped from 3  $\rightarrow$  2.9V**

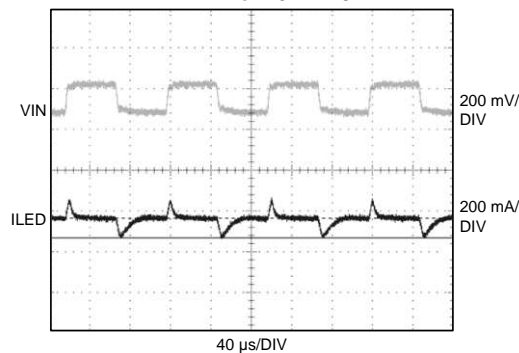


Figure 30.

**LM3556 GENERAL INFORMATION**

The LM3556 is a high-power white LED flash driver capable of delivering up to 1.5A into a single high-powered LED. The device incorporates a 4 MHz constant frequency-synchronous current-mode PWM boost converter, and a single high-side current source to regulate the LED current over the 2.5V to 5.5V input voltage range.

The LM3556 PWM converter switches and maintains at least  $V_{HR}$  across the current source (LED). This minimum headroom voltage ensures that the current source remains in regulation. If the input voltage is above the LED voltage + current source headroom voltage the device does not switch and turns the PFET on continuously (Pass mode). In Pass mode the difference between  $(V_{IN} - I_{LED} \times R_{PMOS})$  and the voltage across the LED is dropped across the current source.

The LM3556 has three logic inputs including a hardware Flash Enable (STROBE), a hardware Torch Enable (TORCH) used for external torch mode control and custom LED indication waveforms, and a Flash Interrupt input (TX) designed to interrupt the flash pulse during high battery current conditions. All three logic inputs have internal 300 k $\Omega$  (typ.) pulldown resistors to GND.

Additional features of the LM3556 include an internal comparator for LED thermal sensing via an external NTC thermistor and an input voltage monitor that can reduce the Flash current (during low  $V_{IN}$  conditions).

Control of the LM3556 is done via an I<sup>2</sup>C-compatible interface. This includes adjustment of the Flash and Torch current levels, changing the Flash Timeout Duration, changing the switch current limit, and enabling the NTC block. Additionally, there are flag and status bits that indicate flash current time-out, LED over-temperature condition, LED failure (open/short), device thermal shutdown, TX interrupt, and  $V_{IN}$  under-voltage conditions.

### Startup (Enabling the Device)

Turn on of the LM3556 Torch and Flash modes can be done through the [Enable Register \(0x0A\)](#). On startup, when  $V_{OUT}$  is less than  $V_{IN}$  the internal synchronous PFET turns on as a current source and delivers 200 mA (typ.) to the output capacitor. During this time the current source (LED) is off. When the voltage across the output capacitor reaches 2.2V (typ.) the current source will turn on. At turn-on the current source will step through each FLASH or TORCH level until the target LED current is reached. This gives the device a controlled turn-on and limits inrush current from the  $V_{IN}$  supply.

### Pass Mode

The LM3556 starts up in Pass Mode and stays there until Boost Mode is needed to maintain regulation. If the voltage difference between  $V_{OUT}$  and  $V_{LED}$  falls below  $V_{HR}$ , the device switches to Boost Mode. In Pass Mode the boost converter does not switch, and the synchronous PFET turns fully on bringing  $V_{OUT}$  up to  $V_{IN} - I_{LED} \times R_{PMOS}$ . In Pass Mode the inductor current is not limited by the peak current limit. In this situation the output current must be limited to 2A.

### Flash Mode

In Flash Mode, the LED current source (LED) provides 16 target current levels from 93.75 mA to 1500 mA. The Flash currents are adjusted via the [Current Control Register \(0x09\)](#). Flash mode is activated by the [Enable Register \(0x0A\)](#), or by pulling the STROBE pin HIGH. Once the Flash sequence is activated the current source (LED) will ramp up to the programmed Flash current by stepping through all current steps until the programmed current is reached.

When the part is enabled in Flash Mode through the Enable Register, all mode bits in the Enable Register are cleared after a flash time-out event.

Data can be written to the mode bits (bits[1:0]) in [Enable Register \(0x0A\)](#) only after the flash has ramped down to the desired value, and  $V_{OUT}$  has decayed.

The following table shows the I<sup>2</sup>C commands and the state of the mode bits, if the STROBE pin is used to enable the Flash Mode.

Mode change required	Enable and Configuration Register Setting (0x0A=Enable Register, 0x07=Configuration Register)	Status of Mode Bits in the Enable Register after a flash.
Using Edge Triggered STROBE to Flash	0x0A=0x23; 0x07=0x78 (default setting)	Mode bits are cleared after a single flash. To reflash, 0x23 will have to be written to 0x0A.
Using Level Triggered STROBE to Flash	0x0A=0x23; 0x07=0xF8	Mode bits are cleared after a single flash. To reflash, 0x23 will have to be written to 0x0A.
Part is required to go from External TORCH Mode to External STROBE mode using Edge Triggered STROBE	0x0A=0x33; 0x07=0x78 (default setting)	Mode bits are cleared after a single flash. To reflash, 0x33 will have to be written to 0x0A.
Part is required to go from External TORCH Mode to External STROBE mode using Level Triggered STROBE	0x0A=0x33; 0x07=0xF8	Mode bits are cleared only if the part has an internal flash time-out event happening before the STROBE level goes low. To reflash, 0x33 will have to be written to 0x0A. If the STROBE level goes low before an internal flash time-out event, then mode bits are not cleared.

## Torch Mode

In Torch Mode, the current source (LED) is programmed via the [Current Control Register \(0x09\)](#). Torch Mode is activated by the [Enable Register \(0x0A\)](#) or by the hardware TORCH input. Once the Torch Mode is enabled the current source will ramp up to the programmed Torch current level. The Ramp-Up and Ramp-Down times are independently adjustable via the [Torch Ramp Time Register \(0x06\)](#). Torch Mode is not affected by Flash Timeout.

## Indicator Mode

This mode has two options: the Internal Indicator Mode and the External Indicator Mode. Both these modes are activated by the [Configuration Register \(0x07\)](#) in addition to the [Enable Register \(0x0A\)](#).

In the Internal Indicator Mode, the current source (LED) can be programmed to 8 different intensity levels, with current values being 1/8th the values in [Current Control Register \(0x09\)](#) bits [6:4]. The Ramp-Up, Ramp-Down, the pulse time, number of Blanks and Periods of the desired output current can be independently controlled via the [Indicator Ramp Time Indicator \(0x03\)](#), [Indicator Blinking Register \(0x04\)](#) and the [Indicator Period Count Register \(0x05\)](#).

In the External Indicator Mode, the current source (LED) is controlled via the TORCH pin. An external PWM signal can be input to the part via the TORCH pin to choose any one of the 8 available intensity settings (Bits [6:4] of the [Current Control Register \(0x09\)](#)) for the current source (LED).

## Power Amplifier Synchronization (TX)

The TX pin is a Power Amplifier Synchronization input. This is designed to reduce the flash LED current and thus limit the battery current during high battery current conditions such as PA transmit events. When the LM3556 is engaged in a Flash event, and the TX pin is pulled high, the LED current is forced into Torch Mode at the programmed Torch current setting or shutdown. If the TX pin is then pulled low before the Flash pulse terminates, the LED current will return to the previous Flash current level. At the end of the Flash time-out, whether the TX pin is high or low, the LED current will turn off. The polarity of the TX input can be changed from active high to active low through the [Configuration Register \(0x07\)](#) and can be disabled/enabled by setting the TX Enable bit in the [Enable Register \(0x0A\)](#) to a '0'.

## Input Voltage Flash Monitor (IVFM)

The LM3556 has the ability to adjust the flash current based upon the voltage level present at the IN pin utilizing an Input Voltage Flash Monitor. Two adjustable thresholds (IVM-D and IVM-U) ranging from 2.9V to 3.6V in 100 mV steps, and four different usage modes (Report Mode, Stop and Hold, Adjust Down Only, Adjust Up and Down), are provided. The Flags register has the fault flag set when the input voltage crosses the IVM-D value. In the Report Mode, apart from the fault flag triggering, no action is taken on the LED current. Additionally, the IVM-D threshold sets the input voltage boundary that forces the LM3556 to either stop ramping the flash current during startup (Stop and Hold Mode) or to start decreasing the LED current during the flash (Adjust Down Only and Adjust Down and Up). The IVM-U threshold sets the input voltage boundary that forces the LM3556 to start ramping the flash current back up towards the target (Adjust Up and Down Mode). The IVM-U threshold is equal to the IVM-D value plus the programmed hysteresis value also stored in the [Input Voltage Flash Monitor \(IVFM\) Mode Register \(0x01\)](#).

To help prevent a premature current reduction, the LM3556 has four different filter timers that start once the input voltage decreases below the IVM-D line. These filter times are set in the [Silicon Revision and Filter Time Register \(0x00\)](#). For more information, please refer to the [Input Voltage Flash Monitor \(IVFM\) Mode Register \(0x01\)](#) and [Configuration Register \(0x07\)](#) sections of this datasheet.

## Fault Protections

### Fault Operation

Upon entering a fault condition, the LM3556 will set the appropriate flag in the [Flags Register \(0x0B\)](#), placing the part into standby by clearing and locking the Torch Enable bit (TEN), Pre-Charge bit and Mode Bits (M1, M0) in the [Enable Register \(0x0A\)](#), until the [Flags Register \(0x0B\)](#) is read back via I<sup>2</sup>C.

### Flash Time-Out

The Flash Time-Out period sets the amount of time that the Flash Current is being sourced from the current source (LED). The LM3556 has 8 time-out levels ranging 100 ms to 800 ms in 100 ms steps. The Flash Time-Out period is controlled in the [Flash Features Register \(0x08\)](#). Flash Time-Out only applies to the Flash Mode operation. The mode bits are cleared upon a Flash Time-out.

### Over-Voltage Protection (OVP)

The output voltage is limited to typically 5.0V (see  $V_{OVP}$  Spec). In situations such as an open LED, the LM3556 will raise the output voltage in order to keep the LED current at its target value. When  $V_{OUT}$  reaches 5.0V (typ.), the over-voltage comparator will trip and turn off the internal NFET. When  $V_{OUT}$  falls below the “ $V_{OVP}$  Off Threshold”, the LM3556 will begin switching again. The mode bits in the [Enable Register \(0x0A\)](#) are not cleared upon an OVP.

### Current Limit

The LM3556 features selectable inductor current limits that are programmable through the [Flash Features Register \(0x08\)](#) of the I<sup>2</sup>C-compatible interface. When the inductor current limit is reached, the LM3556 will terminate the charging phase of the switching cycle.

Since the current limit is sensed in the NMOS switch, there is no mechanism to limit the current when the device operates in Pass Mode. In Boost mode or Pass Mode if  $V_{OUT}$  falls below 2.3V, the part stops switching, and the PFET operates as a current source limiting the current to 200 mA. This prevents damage to the LM3556 and excessive current draw from the battery during output short-circuit conditions. The mode bits in the [Enable Register \(0x0A\)](#) are not cleared upon a Current Limit event.

**Pulling additional current from the  $V_{OUT}$  node during normal operation is not recommended.**

### NTC Thermistor Input (TEMP)

The TEMP pin serves as a threshold detector for negative temperature coefficient (NTC) thermistors. It interrupts the LED current when the voltage at TEMP goes below the programmed threshold. The NTC threshold voltage is adjustable from 200 mV to 900 mV in 100 mV steps. The NTC current is adjustable from 25  $\mu$ A to 100  $\mu$ A in 25  $\mu$ A steps. When an over-temperature event is detected, the LM3556 can be set to force the LED current from Flash Mode into Torch Mode or into shutdown. These settings are adjusted via the [NTC Settings Register \(0x02\)](#), and the NTC detection circuitry can be enabled or disabled via the [Enable Register \(0x0A\)](#). If enabled, the NTC block will turn on and off during the start and stop of a Flash/Torch/Indicator event. The NTC mode of operation is set by adjusting the NTC Mode bit in the [Configuration Register \(0x07\)](#). See the [NTC Settings Register \(0x02\)](#) section for more details. The mode bits in the [Enable Register \(0x0A\)](#) are cleared upon an NTC event.

### Under-Voltage Lockout (UVLO)

The LM3556 has an internal comparator that monitors the voltage at IN and will force the LM3556 into shutdown if the input voltage drops to 2.8V. If the UVLO monitor threshold is tripped, the UVLO flag bit will be set in the [Flags Register \(0x0B\)](#). If the input voltage rises above 2.8V, the LM3556 will not be available for operation until there is an I<sup>2</sup>C read command initiated for the [Flags Register \(0x0B\)](#). Upon a read, the flag register will be cleared, and normal operation can resume. This feature can be disabled by writing a '0' to the UVLO EN bit in the [Input Voltage Flash Monitor \(IVFM\) Mode Register \(0x01\)](#). The mode bits in the [Enable Register \(0x0A\)](#) are cleared upon a UVLO event.

### Thermal Shutdown (TSD)

When the LM3556's die temperature reaches +150°C, the boost converter shuts down, and the NFET and PFET turn off, as does the current source (LED). When the thermal shutdown threshold is tripped, a '1' gets written to the corresponding bit of the [Flags Register \(0x0B\)](#) (Thermal Shutdown bit), and the LM3556 will go into standby. The LM3556 will only be allowed to restart after the [Flags Register \(0x0B\)](#) is read, clearing the fault flag. Upon restart, if the die temperature is still above +150°C, the LM3556 will reset the Fault flag and re-enter standby. The mode bits in the [Enable Register \(0x0A\)](#) are cleared upon a TSD.

### LED and/or $V_{OUT}$ Fault

The LED Fault flag in the [Flags Register \(0x0B\)](#) reads back a '1' if the part is active in Flash Mode or Torch Mode, and the LED output or the  $V_{OUT}$  node experiences short condition. The LM3556 determines an LED open condition if the OVP threshold is crossed at the OUT pin while the device is in Flash Mode or Torch Mode. An LED short condition is determined if the voltage at LED goes below 500 mV (typ.) while the device is in either Torch or Flash Mode. There is a delay of 256  $\mu$ s deglitch time before the LED flag is valid, and 2.048 ms before the  $V_{OUT}$  flag is valid. This delay is the time between when the Flash or Torch current is triggered and when the LED voltage and the output voltage are sampled. The LED flag can only be reset to '0' by removing power to the LM3556, or by reading back the [Flags Register \(0x0B\)](#). The mode bits in the [Enable Register \(0x0A\)](#) are cleared upon an LED and/or  $V_{OUT}$  fault.

## I<sup>2</sup>C-COMPATIBLE INTERFACE

### Data Validity

The data on SDA line must be stable during the HIGH period of the clock signal (SCL). In other words, state of the data line can only be changed when SCL is LOW.

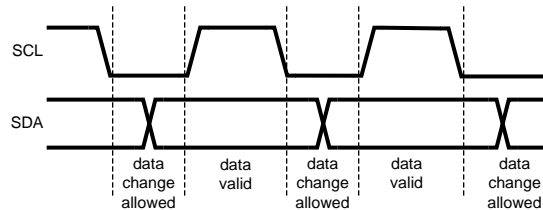


Figure 31. Data Validity Diagram

A pullup resistor between the controller's VIO line and SDA must be greater than  $[(VIO - V_{OL}) / 3mA]$  to meet the  $V_{OL}$  requirement on SDA. Using a larger pullup resistor results in lower switching current with slower edges, while using a smaller pullup results in higher switching currents with faster edges.

### Start and Stop Conditions

START and STOP conditions classify the beginning and the end of the I<sup>2</sup>C session. A START condition is defined as the SDA signal transitioning from HIGH to LOW while SCL line is HIGH. A STOP condition is defined as the SDA transitioning from LOW to HIGH while SCL is HIGH. The I<sup>2</sup>C master always generates START and STOP conditions. The I<sup>2</sup>C bus is considered to be busy after a START condition and free after a STOP condition. During data transmission, the I<sup>2</sup>C master can generate repeated START conditions. First START and repeated START conditions are equivalent, function-wise.

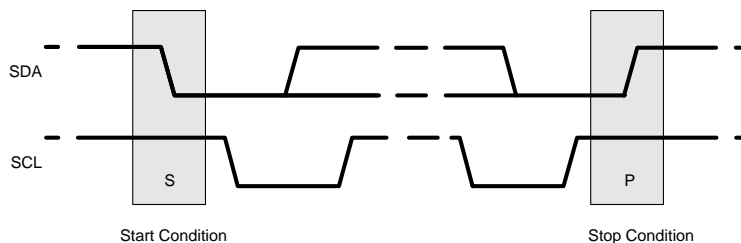
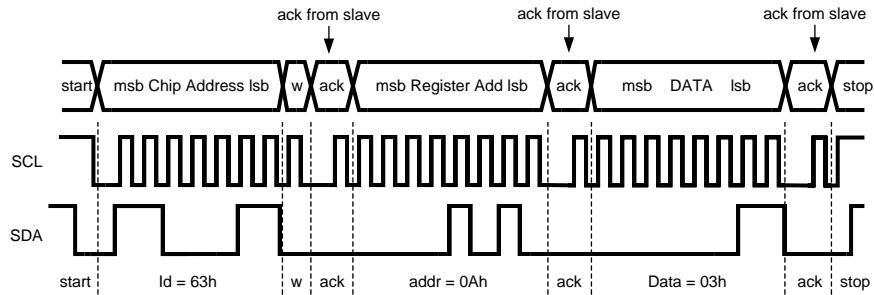


Figure 32. Start and Stop Conditions

### Transferring Data

Every byte put on the SDA line must be eight bits long, with the most significant bit (MSB) transferred first. Each byte of data has to be followed by an acknowledge bit. The acknowledge related clock pulse is generated by the master. The master releases the SDA line (HIGH) during the acknowledge clock pulse. The LM3556 pulls down the SDA line during the 9th clock pulse, signifying an acknowledge. The LM3556 generates an acknowledge after each byte is received. There is no acknowledge created after data is read from the LM3556.

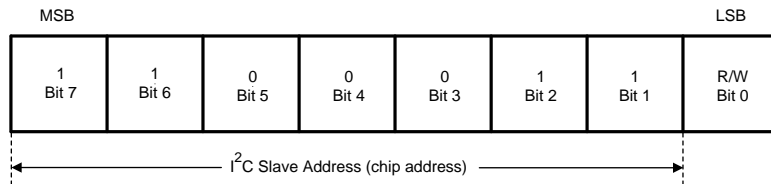
After the START condition, the I<sup>2</sup>C master sends a chip address. This address is seven bits long followed by an eighth bit which is a data direction bit (R/W). The LM3556 7-bit address is 0x63. For the eighth bit, a '0' indicates a WRITE and a '1' indicates a READ. The second byte selects the register to which the data will be written. The third byte contains data to write to the selected register.



**Figure 33. Write Cycle**  
**w = write (SDA = "0")**  
**r = read (SDA = "1")**  
**ack = acknowledge (SDA pulled down by either master or slave)**  
**id = chip address, 63h for LM3556**

**I<sup>2</sup>C-Compatible Chip Address**

The device address for the LM3556 is 1100011 (63). After the START condition, the I<sup>2</sup>C-compatible master sends the 7-bit address followed by an eighth read or write bit (R/W). R/W = 0 indicates a WRITE and R/W = 1 indicates a READ. The second byte following the device address selects the register address to which the data will be written. The third byte contains the data for the selected register.



**Figure 34. I<sup>2</sup>C-Compatible Device Address**

**Transferring Data**

Every byte on the SDA line must be eight bits long, with the most significant bit (MSB) transferred first. Each byte of data must be followed by an acknowledge bit (ACK). The acknowledge related clock pulse (9th clock pulse) is generated by the master. The master releases SDA (HIGH) during the 9th clock pulse. The LM3556 pulls down SDA during the 9th clock pulse, signifying an acknowledge. An acknowledge is generated after each byte has been received.



## REGISTER DESCRIPTIONS

Register Name	Internal Hex Address	Power On/RESET Value
Silicon Revision and Filter Time Register	0x00	0x04
IVFM Mode Register	0x01	0x80
NTC Settings Register	0x02	0x12
Indicator Ramp Time Register	0x03	0x00
Indicator Blinking Register	0x04	0x00
Indicator Period Count Register	0x05	0x00
Torch Ramp Time Register	0x06	0x00
Configuration Register	0x07	0x78
Flash Features Register	0x08	0xD2
Current Control Register	0x09	0x0F
Enable Register	0x0A	0x00
Flags Register	0x0B	0x00

### Silicon Revision and Filter Time Register (0x00)

Bit 7	Bit 6	Bit 5	Bit 4	Bit 3	Bit 2	Bit 1	Bit 0
RFU	RFU	RFU	<b>IVFM Filter Times</b> '00' = 1/2 of the Current Step Time '01' = 256 $\mu$ s '10' = 512 $\mu$ s '11' = 1024 $\mu$ s		Bits available for Silicon Revision Current Value = '100'		

### Input Voltage Flash Monitor (IVFM) Mode Register (0x01)

Bit 7	Bit 6	Bit 5	Bit 4	Bit 3	Bit 2	Bit 1	Bit 0
1 = UVLO EN (default)	<b>Hysteresis Level</b> 00 = 50 mV (default) 01 = 100 mV 10 = 150 mV 11 = Hysteresis Disabled		<b>IVM-D (Down) Threshold</b> 000 = 2.9V (default) 001 = 3.0V 010 = 3.1V 011 = 3.2V 100 = 3.3V 101 = 3.4V 110 = 3.5V 111 = 3.6V			<b>IVFM Adjust Mode</b> 00 = Report Mode (default) 01 = Stop and Hold Mode 10 = Down Mode 11 = Up and Down Mode	

**00 = Report Mode** Sets IVFM Flag in Flags Register upon crossing IVM-D Line Only. Does not adjust current.

**01 = Stop and Hold Mode** Stops Current Ramp and Holds the level for the remaining flash if  $V_{IN}$  crosses IVM-D Line. Sets IVFM Flag in Flags Register upon crossing IVM-D Line.

**10 = Down Mode** Adjusts current down if  $V_{IN}$  crosses IVM-D Line and will stop decreasing once  $V_{IN}$  rises above the IVM-D line + the IVFM hysteresis setting. The LM3556 will decrease the current throughout the flash pulse anytime the input voltage falls below the IVM-D line, and not just once. The flash current will not increase again until the next flash. Sets IVFM Flag in Flags Register upon crossing IVM-D Line.

**11 = Up and Down Mode** Adjusts current down if  $V_{IN}$  crosses IVM-D Line and adjusts current up if  $V_{IN}$  rises above the IVM-D line + the IVFM hysteresis setting. In this mode, the current will continually adjust with the rising and falling of the input voltage throughout the entire flash pulse. Sets IVFM Flag in Flags Register upon crossing IVM-D Line.

**UVLO EN** If enabled and  $V_{IN}$  drops below 2.8V, the LM3556 will enter standby and set the UVLO flag in the Flags Register. Enabled = '1', Disabled = '0'

**IVM-U = IVM-D + IVFM Hysteresis**

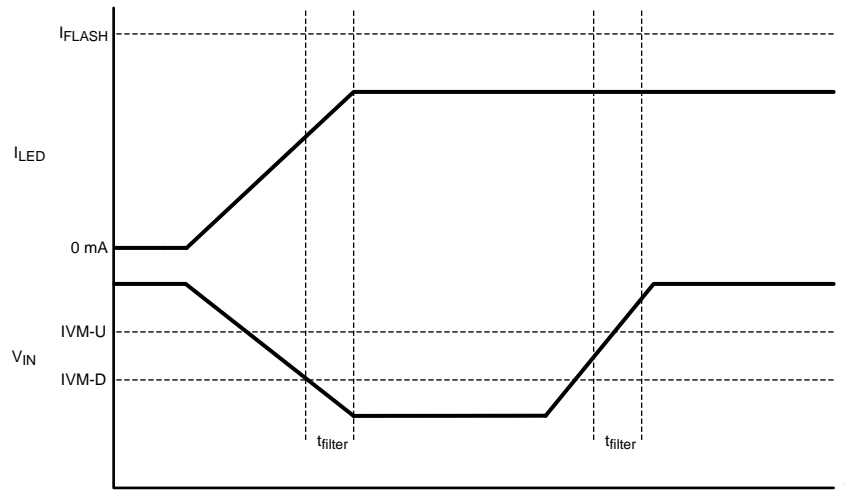


Figure 35. Stop and Hold Mode

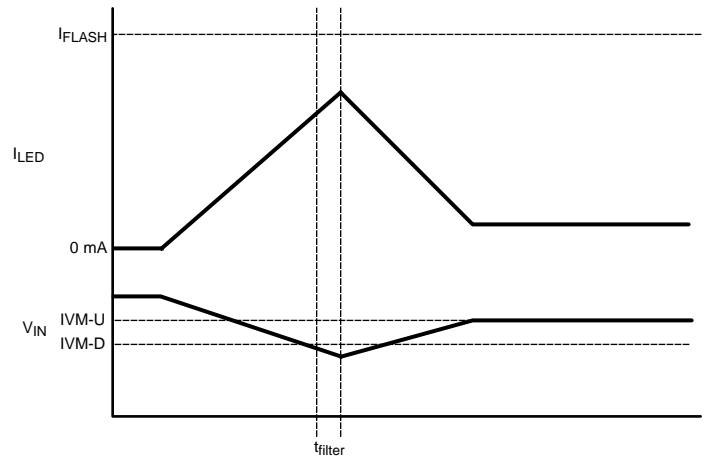


Figure 36. Adjust Down Only Mode

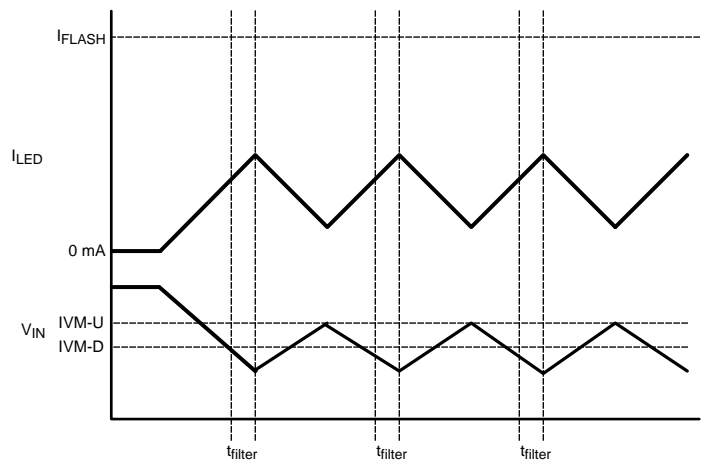
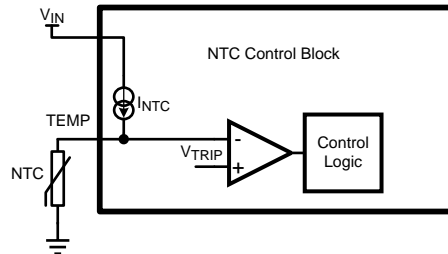


Figure 37. Adjust Up and Down Mode

**NTC Settings Register (0x02)**

Bit 7	Bit 6	Bit 5	Bit 4	Bit 3	Bit 2	Bit 1	Bit 0
RFU	RFU	<b>NTC Event Level</b> 0 = Go to Standby (default) 1 = Reduce to Min Torch Current	<b>NTC Trip Thresholds</b> 000 = 200 mV 001 = 300 mV 010 = 400 mV 011 = 50 mV 100 = 600 mV (default) 101 = 700 mV 110 = 800 mV 111 = 900 mV			<b>NTC Bias Current Level</b> 00 = 25 $\mu$ A 01 = 50 $\mu$ A 10 = 75 $\mu$ A (default) 11 = 100 $\mu$ A	



**Figure 38. NTC Control Block**

The TEMP node is connected to an NTC resistor as shown in Figure 38 above. A constant current source from the input is connected to this node. Any change in the voltage because of a change in the resistance of the NTC resistor is compared to a set  $V_{TRIP}$ . The trip thresholds are selected by Bits[4:2] of the NTC Register. The output of the Control Logic upon an NTC trip is selected through Bit[5].

**Indicator Ramp Time Indicator (0x03)**

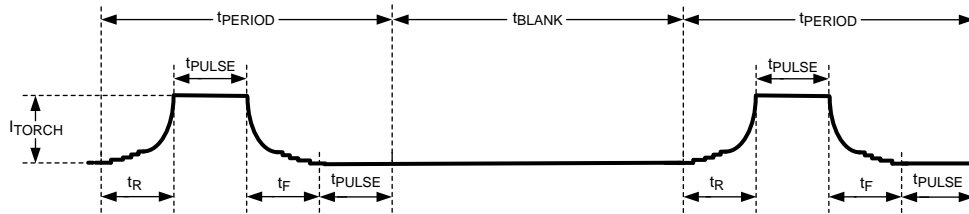
Bit 7	Bit 6	Bit 5	Bit 4	Bit 3	Bit 2	Bit 1	Bit 0
RFU	RFU	<b>Indicator Ramp-Up Time (<math>t_R</math>)</b> 000 = 16 ms (default) 001 = 32 ms 010 = 64 ms 011 = 128 ms 100 = 256 ms 101 = 512 ms 110 = 1.024s 111 = 2.048s			<b>Indicator Ramp-Down Time (<math>t_F</math>)</b> 000 = 16 ms (default) 001 = 32 ms 010 = 64 ms 011 = 128 ms 100 = 256 ms 101 = 512 ms 110 = 1.024s 111 = 2.048s		

**Indicator Blinking Register (0x04)**

Bit 7	Bit 6	Bit 5	Bit 4	Bit 3	Bit 2	Bit 1	Bit 0
<b><math>N_{BLANK}</math></b> 0000 = 0 (default) 0001 = 1 0010 = 2 0011 = 3 0100 = 4 0101 = 5 0110 = 6 0111 = 7 1000 = 8 1001 = 9 1010 = 10 1011 = 11 1100 = 12 1101 = 13 1110 = 14 1111 = 15				<b>Pulse Time (<math>t_{PULSE}</math>)</b> 0000 = 0 (default) 0001 = 32 ms 0010 = 64 ms 0011 = 92 ms 0100 = 128 ms 0101 = 160 ms 0110 = 196 ms 0111 = 224 ms 1000 = 256 ms 1001 = 288 ms 1010 = 320 ms 1011 = 352 ms 1100 = 384 ms 1101 = 416 ms 1110 = 448 ms 1111 = 480 ms			

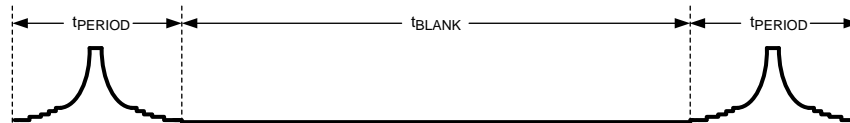
**Indicator Period Count Register (0x05)**

Bit 7	Bit 6	Bit 5	Bit 4	Bit 3	Bit 2	Bit 1	Bit 0
RFU	RFU	RFU	RFU	RFU	$N_{PERIOD}$ 000 = 0 (default) 001 = 1 010 = 2 011 = 3 100 = 4 101 = 5 110 = 6 111 = 7		

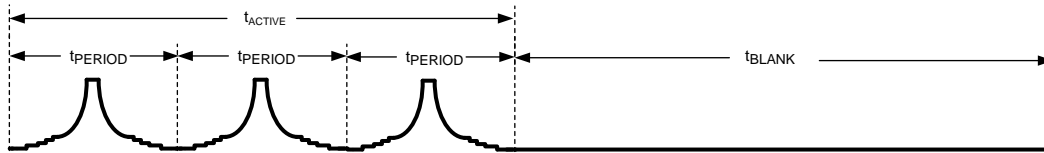


**Figure 39. Indicator Usage**

1. Number of periods ( $t_{PERIOD} = t_R + t_F + t_{PULSE} \times 2$ )
2. Active Time ( $t_{ACTIVE} = t_{PERIOD} \times N_{PERIOD}$ )
3. Blank Time ( $t_{BLANK} = t_{ACTIVE} \times N_{BLANK}$ )



**Figure 40. Single Pulse with Dead Time**



**Figure 41. Multiple Pulse with Dead Time**

**Torch Ramp Time Register (0x06)**

Bit 7	Bit 6	Bit 5	Bit 4	Bit 3	Bit 2	Bit 1	Bit 0
RFU	RFU	<b>Torch Ramp-Up Time</b> 000 = 16 ms (default) 001 = 32 ms 010 = 64 ms 011 = 128 ms 100 = 256 ms 101 = 512 ms 110 = 1.024s 111 = 2.048s			<b>Torch Ramp-Down Time</b> 000 = 16 ms (default) 001 = 32 ms 010 = 64 ms 011 = 128 ms 100 = 256 ms 101 = 512 ms 110 = 1.024s 111 = 2.048s		

**Configuration Register (0x07)**

Bit 7	Bit 6	Bit 5	Bit 4	Bit 3	Bit 2	Bit 1	Bit 0
<b>Strobe Usage</b> 0 = Edge (default) 1 = Level	<b>Strobe Pin Polarity</b> 0 = Active Low 1 = Active High (default)	<b>Torch Pin Polarity</b> 0 = Active Low 1 = Active High (default)	<b>TX Pin Polarity</b> 0 = Active Low 1 = Active High (default)	<b>TX Event Level</b> 0 = Off 1 = Torch Current (default)	<b>IVFM Enable</b> 0 = Disabled (default) 1 = Enabled	<b>NTC Mode</b> 0 = Normal (default) 1 = Monitor	<b>Indicator Mode</b> 0 = Internal (default) 1 = External

**Strobe Usage** Level or Edge. Flash will follow Strobe timing if Level and internal timing if Edge.

**Strobe Polarity** Active High or Active Low Select.

**Torch Polarity** Active High or Active Low Select.

**TX Polarity** Active High or Active Low Select.

**TX Event Level** Transition to Torch Current Level or Off if TX event occurs.

The TX Event Level "Off" setting is designed to only force a shutdown during a flash event. When Torch or Indicator Mode is enabled, and a TX event occurs with the TX Event Level set to "Off", the LM3556 does not shut down. The TX flag bit (bit7 in the [Flags Register \(0x0B\)](#)) will be set, and the mode bits (bit0 and bit1 in [Enable Register \(0x0A\)](#)) get locked out until the fault register is cleared via an I<sup>2</sup>C read. Because a TX event is periodic and frequently occurring, clearing the fault register becomes more difficult. Depending on the I<sup>2</sup>C read/write speed and TX event frequency, it may be necessary to set the TX enable bit (bit6 in the [Enable Register \(0x0A\)](#)) to a '0' before clearing the fault register to prevent future flag sets.

**IVFM Enable** Enables Input Voltage Flash Monitoring.

**NTC Mode** Monitor Mode (Report Only) or Normal Mode (Reduce Current or Shutdown).

**Indicator Mode** Externally generated via TORCH Pin or internally generated PWM.

**Flash Features Register (0x08)**

Bit 7	Bit 6	Bit 5	Bit 4	Bit 3	Bit 2	Bit 1	Bit 0
<b>Inductor Current Limit</b> 00 = 1.7A 01 = 1.9A 10 = 2.5A 11 = 3.1A (default)		<b>Flash Ramp Time</b> 000 = 256 $\mu$ s 001 = 512 $\mu$ s 010 = 1.024 ms (default) 011 = 2.048 ms 100 = 4.096 ms 101 = 8.192 ms 110 = 16.384 ms 111 = 32.768 ms			<b>Flash Time-Out Time</b> 000 = 100 ms 001 = 200 ms 010 = 300 ms (default) 011 = 400 ms 100 = 500 ms 101 = 600 ms 110 = 700 ms 111 = 800 ms		

**Current Control Register (0x09)**

Bit 7	Bit 6	Bit 5	Bit 4	Bit 3	Bit 2	Bit 1	Bit 0
RFU	<b>Torch Current</b> 000 = 46.88 mA (default) 001 = 93.75 mA 010 = 140.63 mA 011 = 187.5 mA 100 = 234.38 mA 101 = 281.25 mA 110 = 328.13 mA 111 = 375 mA			<b>Flash Current</b> 0000 = 93.75 mA 0001 = 187.5 mA 0010 = 281.25 mA 0011 = 375 mA 0100 = 468.75 mA 0101 = 562.5 mA 0110 = 656.25 mA 0111 = 750 mA 1000 = 843.75 mA 1001 = 937.5 mA 1010 = 1031.25 mA 1011 = 1125 mA 1100 = 1218.75 mA 1101 = 1312.5 mA 1110 = 1406.25 mA 1111 = 1500 mA (default)			

### Enable Register (0x0A)

Bit 7	Bit 6	Bit 5	Bit 4	Bit 3	Bit 2	Bit 1	Bit 0
<b>NTC Enable</b> 0 = Disabled (default) 1 = Enabled	<b>TX Pin Enable</b> 0 = Disabled (default) 1 = Enabled	<b>STROBE Pin Enable</b> 0 = Disabled (default) 1 = Enabled	<b>TORCH Pin Enable</b> 0 = Disabled (default) 1 = Enabled	<b>PreCharge Mode Enable</b> 0 = Normal (default) 1 = PreCharge	<b>Pass-Mode Only Enable</b> 0 = Normal (default) 1 = Pass Only	Mode Bits: M1, M0 00 = Standby (default) 01 = Indicator 10 = Torch 11 = Flash	

### Enable Register (8 Bits)

**NTC EN** Enables NTC Block.

**TX EN** Allows TX events to change the current.

**Strobe EN** Enables Strobe Pin to start a Flash Event.

**Torch EN** Enables Torch Pin to start a Torch Event.

**PreCharge Mode EN** Enables Pass Mode to pre-charge the output cap.

**Pass-Only Mode EN** Only allows Pass Mode and disallows Boost Mode.

If Pass-Only Mode is enabled during any LED mode (Indicator, Torch or Flash), it will remain enabled until the LM3556 enters the standby state regardless of whether the Pass-Only Mode bit is reset or not during the following command.

### Two-Mode Bits

**00–Standby** Off

**01–Indicator** Sets Indicator Mode. Default Indicator Mode uses external pattern on TORCH Pin.

**10–Torch** Sets Torch Mode with ramping. If Torch EN = 0, Torch will start after I<sup>2</sup>C-compatible command.

**11–Flash** Sets Flash Mode with ramping. If Strobe EN = 0, Flash will start after I<sup>2</sup>C-compatible command.

### Flags Register (0x0B)

Bit 7	Bit 6	Bit 5	Bit 4	Bit 3	Bit 2	Bit 1	Bit 0
<b>TX Event</b> 0 = Default	<b>NTC Trip</b> 0 = Default	<b>IVFM</b> 0 = Default	<b>UVLO</b> 0 = Default	<b>OVP</b> 0 = Default	<b>LED or VOUT Short Fault</b> 0 = Default	<b>Thermal Shutdown</b> 0 = Default	<b>Flash Time-out</b> 0 = Default

**TX Event Flag** TX Event occurred.

**NTC Trip Flag** NTC Threshold crossed.

**IVFM Flag** IVFM block reported and/or adjusted LED current.

**UVLO Fault** UVLO Threshold crossed.

**OVP Flag** Over-voltage Protection tripped. Open Output cap or open LED.

**LED Short Fault** LED Short detected.

**Thermal Shutdown Fault** LM3556 die temperature reached thermal shutdown value.

**Time-Out Flag** Flash Timer tripped

**Note:** Faults require a read-back of the “Flags Register” to resume operation. Flags report an event occurred, but do not inhibit future functionality. A read-back of the Flags Register will only be updated again if the fault or flags is still present upon a restart.

Control Logic Delays

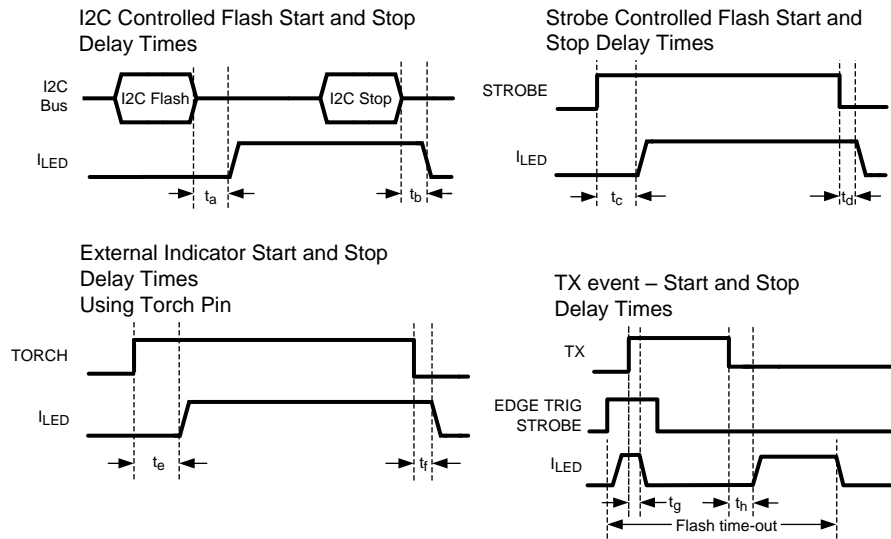


Figure 42. Control Logic Delays

Delay	Explanation	Time
$t_a$	Time for the LED current to start ramping up after an I <sup>2</sup> C Write command.	554 $\mu$ s
$t_b$	Time for the LED current to start ramping down after an I <sup>2</sup> C Stop command.	32 $\mu$ s
$t_c$	Time for the LED current to start ramping up after the STROBE pin is raised high.	400 $\mu$ s
$t_d$	Time for the LED current to start ramping down after the STROBE pin is pulled low.	16 $\mu$ s
$t_e$	Time for the LED current to start ramping up after the TORCH pin is raised high.	300 $\mu$ s
$t_f$	Time for the LED current to start ramping down after the TORCH pin is pulled low.	16 $\mu$ s
$t_g$	Time for the LED current to start ramping down after the TX pin is pulled high.	3 $\mu$ s
$t_h$	Time for the LED current to start ramping up after the TX pin is pulled low, provide the part has not timed out in Flash M ode.	2 $\mu$ s

## APPLICATION INFORMATION

### Output Capacitor Selection

The LM3556 is designed to operate with a ceramic output capacitor of at least 10  $\mu\text{F}$ . When the boost converter is running, the output capacitor supplies the load current during the boost converter's on-time. When the NMOS switch turns off, the inductor energy is discharged through the internal PMOS switch, supplying power to the load and restoring charge to the output capacitor. This causes a sag in the output voltage during the on-time and a rise in the output voltage during the off-time. The output capacitor is therefore chosen to limit the output ripple to an acceptable level depending on load current and input/output voltage differentials and also to ensure the converter remains stable.

Larger capacitors such as a 22  $\mu\text{F}$  or capacitors in parallel can be used if lower output voltage ripple is desired. To estimate the output voltage ripple considering the ripple due to capacitor discharge ( $\Delta V_Q$ ) and the ripple due to the capacitors ESR ( $\Delta V_{\text{ESR}}$ ) use the following equations:

For continuous conduction mode, the output voltage ripple due to the capacitor discharge is:

$$\Delta V_Q = \frac{I_{\text{LED}} \times (V_{\text{OUT}} - V_{\text{IN}})}{f_{\text{SW}} \times V_{\text{OUT}} \times C_{\text{OUT}}} \quad (1)$$

The output voltage ripple due to the output capacitors ESR is found by:

$$\Delta V_{\text{ESR}} = R_{\text{ESR}} \times \left( \frac{I_{\text{LED}} \times V_{\text{OUT}}}{V_{\text{IN}}} \right) + \Delta I_L$$

where

$$\Delta I_L = \frac{V_{\text{IN}} \times (V_{\text{OUT}} - V_{\text{IN}})}{2 \times f_{\text{SW}} \times L \times V_{\text{OUT}}} \quad (2)$$

In ceramic capacitors the ESR is very low so the assumption is that 80% of the output voltage ripple is due to capacitor discharge and 20% from ESR. [Table 2](#) lists different manufacturers for various output capacitors and their case sizes suitable for use with the LM3556.

### Input Capacitor Selection

Choosing the correct size and type of input capacitor helps minimize the voltage ripple caused by the switching of the LM3556's boost converter, and reduces noise on the boost converter's input terminal that can feed through and disrupt internal analog signals. In the Typical Application Circuit a 10  $\mu\text{F}$  ceramic input capacitor works well. It is important to place the input capacitor as close as possible to the LM3556's input (IN) terminal. This reduces the series resistance and inductance that can inject noise into the device due to the input switching currents. The table below lists various input capacitors recommended for use with the LM3556.

**Table 2. Recommended Input/Output Capacitors (X5R/X7R Dielectric)**

Manufacturer	Part Number	Value	Case Size	Voltage Rating
TDK Corporation	C1608JB0J106M	10 $\mu\text{F}$	0603 (1.6 mm x 0.8 mm x 0.8 mm)	6.3V
TDK Corporation	C2012JB1A106M	10 $\mu\text{F}$	0805 (2 mm x 1.25 mm x 1.25 mm)	10V
Murata	GRM188R60J106M	10 $\mu\text{F}$	0603 (1.6 mm x 0.8 mm x 0.8 mm)	6.3V
Murata	GRM21BR61A106KE19	10 $\mu\text{F}$	0805 (2 mm x 1.25 mm x 1.25 mm)	10V

### Inductor Selection

The LM3556 is designed to use a 1  $\mu\text{H}$  or 0.47  $\mu\text{H}$  inductor. The table below lists various inductors and their manufacturers that work well with the LM3556. When the device is boosting ( $V_{\text{OUT}} > V_{\text{IN}}$ ) the inductor will typically be the largest area of efficiency loss in the circuit. Therefore, choosing an inductor with the lowest possible series resistance is important. Additionally, the saturation rating of the inductor should be greater than the maximum operating peak current of the LM3556. This prevents excess efficiency loss that can occur with inductors that operate in saturation. For proper inductor operation and circuit performance, ensure that the inductor saturation and the peak current limit setting of the LM3556 are greater than  $I_{\text{PEAK}}$  in the following calculation:

$$I_{\text{PEAK}} = \frac{I_{\text{LOAD}}}{\eta} \times \frac{V_{\text{OUT}}}{V_{\text{IN}}} + \Delta I_L \quad \text{where} \quad \Delta I_L = \frac{V_{\text{IN}} \times (V_{\text{OUT}} - V_{\text{IN}})}{2 \times f_{\text{SW}} \times L \times V_{\text{OUT}}} \quad (3)$$

where  $f_{\text{SW}} = 4 \text{ MHz}$ , and efficiency can be found in the Typical Performance Characteristics plots.



**Table 3. Recommended Inductors**

Manufacturer	L	Part Number	Dimensions (LxWxH)	I <sub>SAT</sub>	R <sub>DC</sub>
TOKO	1 μH	FSD0312	3 mm x 3 mm x 1.2 mm	4.5A	43 mΩ
TOKO	1 μH	DFE252010C	2.5 mm x 2 mm x 1 mm	3.4A	60 mΩ
TOKO	1 μH	DFE252012C	2.5 mm x 2 mm x 1.2 mm	3.8A	45 mΩ

### NTC Thermistor Selection

The TEMP pin is a comparator input for flash LED thermal sensing. NTC Mode is intended to monitor an external thermistor which monitors LED temperature and prevents LED overheating. An internal comparator checks the voltage on the TEMP pin against the trip point programmed in the [NTC Settings Register \(0x02\)](#). The thermistor is driven by an internally regulated current source, and the voltage on the TEMP pin is related to the source current and the NTC resistance.

NTC thermistors have a temperature to resistance relationship of:

$$R(T) = R_{25^{\circ}\text{C}} \times e^{\left[ \beta \left( \frac{1}{T^{\circ}\text{C} + 273} - \frac{1}{298} \right) \right]} \quad (4)$$

where  $\beta$  is given in the thermistor datasheet, and  $R_{25^{\circ}\text{C}}$  is the thermistor's value at +25°C.

### Layout Recommendations

The high switching frequency and large switching currents of the LM3556 make the choice of layout important. The following steps should be used as a reference to ensure the device is stable and maintains proper LED current regulation across its intended operating voltage and current range.

1. Place  $C_{IN}$  on the top layer (same layer as the LM3556) and as close to the device as possible. The input capacitor conducts the driver currents during the low-side MOSFET turn-on and turn-off and can see current spikes over 1A in amplitude. Connecting the input capacitor through short, wide traces to both the IN and GND terminals will reduce the inductive voltage spikes that occur during switching which can corrupt the  $V_{IN}$  line.
2. Place  $C_{OUT}$  on the top layer (same layer as the LM3556) and as close as possible to the OUT and GND terminal. The returns for both  $C_{IN}$  and  $C_{OUT}$  should come together at one point, as close to the GND pin as possible. Connecting  $C_{OUT}$  through short, wide traces will reduce the series inductance on the OUT and GND terminals that can corrupt the  $V_{OUT}$  and GND lines and cause excessive noise in the device and surrounding circuitry.
3. Connect the inductor on the top layer close to the SW pin. There should be a low-impedance connection from the inductor to SW due to the large DC inductor current, and at the same time the area occupied by the SW node should be small so as to reduce the capacitive coupling of the high  $dV/dt$  present at SW that can couple into nearby traces.
4. Avoid routing logic traces near the SW node so as to avoid any capacitively coupled voltages from SW onto any high-impedance logic lines such as TORCH, STROBE, HWEN, TEMP, SDA, and SCL. A good approach is to insert an inner layer GND plane underneath the SW node and between any nearby routed traces. This creates a shield from the electric field generated at SW.
5. Terminate the Flash LED cathodes directly to the GND pin of the LM3556. If possible, route the LED returns with a dedicated path so as to keep the high amplitude LED currents out of the GND plane. For Flash LEDs that are routed relatively far away from the LM3556, a good approach is to sandwich the forward and return current paths over the top of each other on two layers. This will help in reducing the inductance of the LED current paths.

**PACKAGING INFORMATION**

Orderable Device	Status (1)	Package Type	Package Drawing	Pins	Package Qty	Eco Plan (2)	Lead/Ball Finish	MSL Peak Temp (3)	Samples (Requires Login)
LM3556TME/NOPB	ACTIVE	DSBGA	YFQ	16	250	Green (RoHS & no Sb/Br)	SNAGCU	Level-1-260C-UNLIM	
LM3556TMX/NOPB	ACTIVE	DSBGA	YFQ	16	3000	Green (RoHS & no Sb/Br)	SNAGCU	Level-1-260C-UNLIM	

(1) The marketing status values are defined as follows:

**ACTIVE:** Product device recommended for new designs.

**LIFEBUY:** TI has announced that the device will be discontinued, and a lifetime-buy period is in effect.

**NRND:** Not recommended for new designs. Device is in production to support existing customers, but TI does not recommend using this part in a new design.

**PREVIEW:** Device has been announced but is not in production. Samples may or may not be available.

**OBSELETE:** TI has discontinued the production of the device.

(2) Eco Plan - The planned eco-friendly classification: Pb-Free (RoHS), Pb-Free (RoHS Exempt), or Green (RoHS & no Sb/Br) - please check <http://www.ti.com/productcontent> for the latest availability information and additional product content details.

**TBD:** The Pb-Free/Green conversion plan has not been defined.

**Pb-Free (RoHS):** TI's terms "Lead-Free" or "Pb-Free" mean semiconductor products that are compatible with the current RoHS requirements for all 6 substances, including the requirement that lead not exceed 0.1% by weight in homogeneous materials. Where designed to be soldered at high temperatures, TI Pb-Free products are suitable for use in specified lead-free processes.

**Pb-Free (RoHS Exempt):** This component has a RoHS exemption for either 1) lead-based flip-chip solder bumps used between the die and package, or 2) lead-based die adhesive used between the die and leadframe. The component is otherwise considered Pb-Free (RoHS compatible) as defined above.

**Green (RoHS & no Sb/Br):** TI defines "Green" to mean Pb-Free (RoHS compatible), and free of Bromine (Br) and Antimony (Sb) based flame retardants (Br or Sb do not exceed 0.1% by weight in homogeneous material)

(3) MSL, Peak Temp. -- The Moisture Sensitivity Level rating according to the JEDEC industry standard classifications, and peak solder temperature.

**Important Information and Disclaimer:** The information provided on this page represents TI's knowledge and belief as of the date that it is provided. TI bases its knowledge and belief on information provided by third parties, and makes no representation or warranty as to the accuracy of such information. Efforts are underway to better integrate information from third parties. TI has taken and continues to take reasonable steps to provide representative and accurate information but may not have conducted destructive testing or chemical analysis on incoming materials and chemicals. TI and TI suppliers consider certain information to be proprietary, and thus CAS numbers and other limited information may not be available for release.

In no event shall TI's liability arising out of such information exceed the total purchase price of the TI part(s) at issue in this document sold by TI to Customer on an annual basis.

**TAPE AND REEL INFORMATION**

**QUADRANT ASSIGNMENTS FOR PIN 1 ORIENTATION IN TAPE**


\*All dimensions are nominal

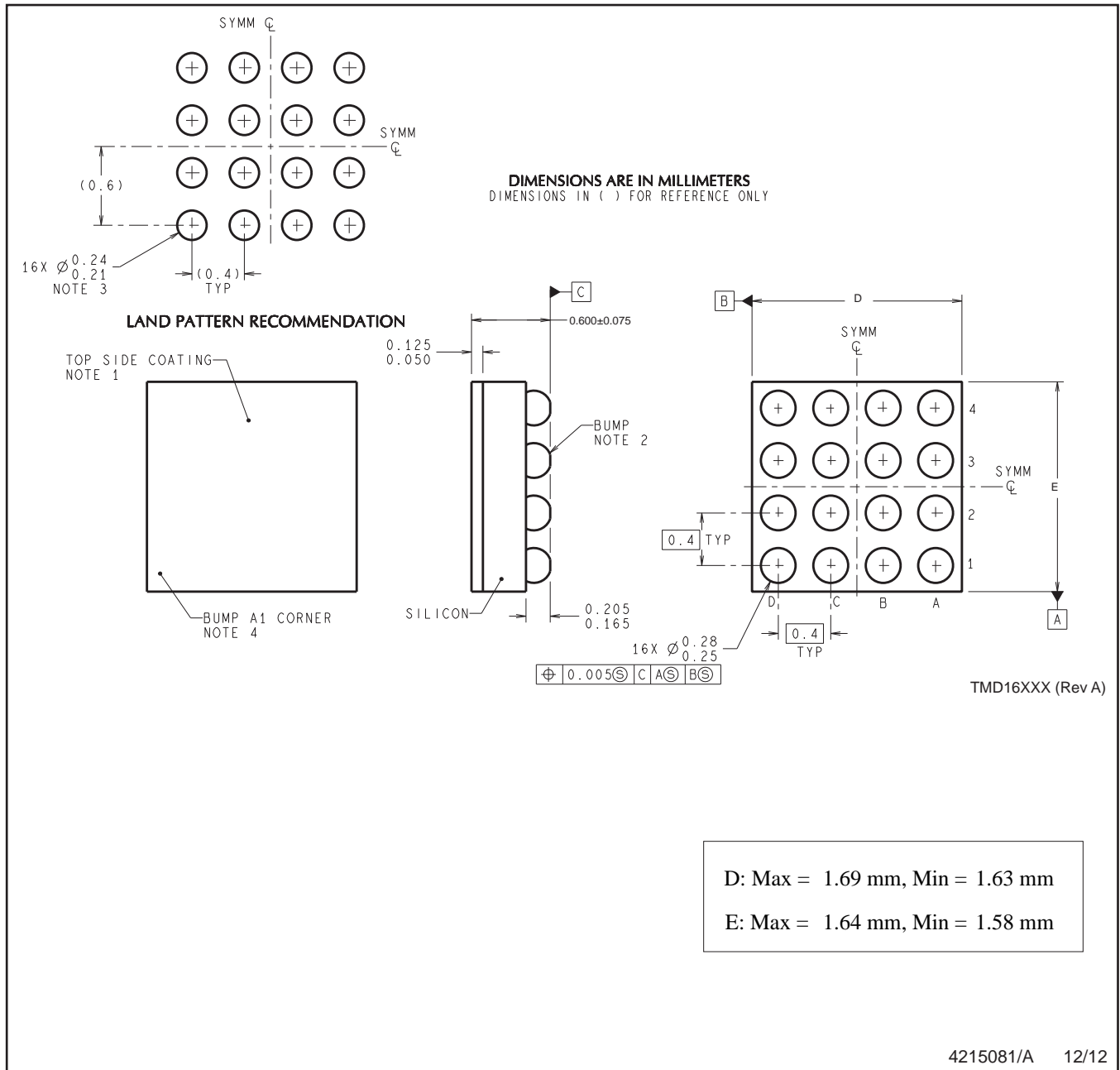
Device	Package Type	Package Drawing	Pins	SPQ	Reel Diameter (mm)	Reel Width W1 (mm)	A0 (mm)	B0 (mm)	K0 (mm)	P1 (mm)	W (mm)	Pin1 Quadrant
LM3556TME/NOPB	DSBGA	YFQ	16	250	178.0	8.4	1.78	1.78	0.69	4.0	8.0	Q1
LM3556TMX/NOPB	DSBGA	YFQ	16	3000	178.0	8.4	1.78	1.78	0.69	4.0	8.0	Q1

**TAPE AND REEL BOX DIMENSIONS**


\*All dimensions are nominal

Device	Package Type	Package Drawing	Pins	SPQ	Length (mm)	Width (mm)	Height (mm)
LM3556TME/NOPB	DSBGA	YFQ	16	250	210.0	185.0	35.0
LM3556TMX/NOPB	DSBGA	YFQ	16	3000	210.0	185.0	35.0

YFQ0016



NOTES: A. All linear dimensions are in millimeters. Dimensioning and tolerancing per ASME Y14.5M-1994.  
B. This drawing is subject to change without notice.

4215081/A 12/12

## IMPORTANT NOTICE

Texas Instruments Incorporated and its subsidiaries (TI) reserve the right to make corrections, enhancements, improvements and other changes to its semiconductor products and services per JESD46, latest issue, and to discontinue any product or service per JESD48, latest issue. Buyers should obtain the latest relevant information before placing orders and should verify that such information is current and complete. All semiconductor products (also referred to herein as "components") are sold subject to TI's terms and conditions of sale supplied at the time of order acknowledgment.

TI warrants performance of its components to the specifications applicable at the time of sale, in accordance with the warranty in TI's terms and conditions of sale of semiconductor products. Testing and other quality control techniques are used to the extent TI deems necessary to support this warranty. Except where mandated by applicable law, testing of all parameters of each component is not necessarily performed.

TI assumes no liability for applications assistance or the design of Buyers' products. Buyers are responsible for their products and applications using TI components. To minimize the risks associated with Buyers' products and applications, Buyers should provide adequate design and operating safeguards.

TI does not warrant or represent that any license, either express or implied, is granted under any patent right, copyright, mask work right, or other intellectual property right relating to any combination, machine, or process in which TI components or services are used. Information published by TI regarding third-party products or services does not constitute a license to use such products or services or a warranty or endorsement thereof. Use of such information may require a license from a third party under the patents or other intellectual property of the third party, or a license from TI under the patents or other intellectual property of TI.

Reproduction of significant portions of TI information in TI data books or data sheets is permissible only if reproduction is without alteration and is accompanied by all associated warranties, conditions, limitations, and notices. TI is not responsible or liable for such altered documentation. Information of third parties may be subject to additional restrictions.

Resale of TI components or services with statements different from or beyond the parameters stated by TI for that component or service voids all express and any implied warranties for the associated TI component or service and is an unfair and deceptive business practice. TI is not responsible or liable for any such statements.

Buyer acknowledges and agrees that it is solely responsible for compliance with all legal, regulatory and safety-related requirements concerning its products, and any use of TI components in its applications, notwithstanding any applications-related information or support that may be provided by TI. Buyer represents and agrees that it has all the necessary expertise to create and implement safeguards which anticipate dangerous consequences of failures, monitor failures and their consequences, lessen the likelihood of failures that might cause harm and take appropriate remedial actions. Buyer will fully indemnify TI and its representatives against any damages arising out of the use of any TI components in safety-critical applications.

In some cases, TI components may be promoted specifically to facilitate safety-related applications. With such components, TI's goal is to help enable customers to design and create their own end-product solutions that meet applicable functional safety standards and requirements. Nonetheless, such components are subject to these terms.

No TI components are authorized for use in FDA Class III (or similar life-critical medical equipment) unless authorized officers of the parties have executed a special agreement specifically governing such use.

Only those TI components which TI has specifically designated as military grade or "enhanced plastic" are designed and intended for use in military/aerospace applications or environments. Buyer acknowledges and agrees that any military or aerospace use of TI components which have **not** been so designated is solely at the Buyer's risk, and that Buyer is solely responsible for compliance with all legal and regulatory requirements in connection with such use.

TI has specifically designated certain components as meeting ISO/TS16949 requirements, mainly for automotive use. In any case of use of non-designated products, TI will not be responsible for any failure to meet ISO/TS16949.

### Products

Audio	<a href="http://www.ti.com/audio">www.ti.com/audio</a>
Amplifiers	<a href="http://amplifier.ti.com">amplifier.ti.com</a>
Data Converters	<a href="http://dataconverter.ti.com">dataconverter.ti.com</a>
DLP® Products	<a href="http://www.dlp.com">www.dlp.com</a>
DSP	<a href="http://dsp.ti.com">dsp.ti.com</a>
Clocks and Timers	<a href="http://www.ti.com/clocks">www.ti.com/clocks</a>
Interface	<a href="http://interface.ti.com">interface.ti.com</a>
Logic	<a href="http://logic.ti.com">logic.ti.com</a>
Power Mgmt	<a href="http://power.ti.com">power.ti.com</a>
Microcontrollers	<a href="http://microcontroller.ti.com">microcontroller.ti.com</a>
RFID	<a href="http://www.ti-rfid.com">www.ti-rfid.com</a>
OMAP Applications Processors	<a href="http://www.ti.com/omap">www.ti.com/omap</a>
Wireless Connectivity	<a href="http://www.ti.com/wirelessconnectivity">www.ti.com/wirelessconnectivity</a>

### Applications

Automotive and Transportation	<a href="http://www.ti.com/automotive">www.ti.com/automotive</a>
Communications and Telecom	<a href="http://www.ti.com/communications">www.ti.com/communications</a>
Computers and Peripherals	<a href="http://www.ti.com/computers">www.ti.com/computers</a>
Consumer Electronics	<a href="http://www.ti.com/consumer-apps">www.ti.com/consumer-apps</a>
Energy and Lighting	<a href="http://www.ti.com/energy">www.ti.com/energy</a>
Industrial	<a href="http://www.ti.com/industrial">www.ti.com/industrial</a>
Medical	<a href="http://www.ti.com/medical">www.ti.com/medical</a>
Security	<a href="http://www.ti.com/security">www.ti.com/security</a>
Space, Avionics and Defense	<a href="http://www.ti.com/space-avionics-defense">www.ti.com/space-avionics-defense</a>
Video and Imaging	<a href="http://www.ti.com/video">www.ti.com/video</a>

### TI E2E Community

[e2e.ti.com](http://e2e.ti.com)