

## DETAILS

<b>Product Number</b>	FN13323_STELLA-A
<b>Family</b>	STELLA
<b>Type</b>	Pack
<b>Color</b>	black
<b>Diameter</b>	90 mm
<b>Height</b>	22 mm
<b>Style</b>	round
<b>Optic Material</b>	Silicone
<b>Holder Material</b>	PA66GF30
<b>Fastening</b>	screw
<b>Status</b>	ready
<b>ROHS Compliant</b>	Yes
<b>Date Updated</b>	1/07/2015



## OPTICAL PROPERTIES

LED	Viewing Angle	Light Beam	Efficiency	cd/lm	Connector
LUXEON CoB 1202/1203	Asym deg	Asymmetric	88 %	0.910	Bender Wirth: 438 Typ L1
NSBxL066A/NFCxL036B	Asymmetric deg	Asymmetric	90 %	0.930	Bender Wirth: 438 Typ L1
CXM-18	Asymmetric deg	Asymmetric	89 %	0.460	-
V15	Asymmetric deg	Asymmetric	91 %	0.550	-
Soleriq P13	Asym deg	Asymmetric	90 %	0.610	-
CXA/B 15xx	Asymmetric deg	Asymmetric	92 %	0.850	Bender Wirth: 441 Typ L1
CXA/B 25xx	Asymmetric deg	Asymmetric	93 %	0.490	-
CXA/B 15xx	Asymmetric deg	Asymmetric	92 %	1.100	-
Soleriq S13	Asymmetric deg	Asymmetric	91 %	0.700	-
CLU710	Asymmetric deg	Asymmetric	89 %	0.960	-
CLU720	Asym deg	Asymmetric	sim: 90 %	0.730	-
CLU730	sim: Asymmetric	Asymmetric	sim: 90 %	sim: 0.000	-
CLU700	Asymmetric deg	Asymmetric	89 %	1.400	Bender Wirth: 434 Typ L1
CLU720	Asymmetric deg	Asymmetric	91 %	0.760	Bender Wirth: 433 Typ L1
VERO13	Asymmetric deg	Asymmetric	92 %	0.660	-
VERO18	Asymmetric deg	Asymmetric	92 %	0.500	-
Soleriq P13	Asymmetric deg	Asymmetric	94 %	0.660	Bender Wirth: 437 Typ L1
Soleriq S13	Asymmetric deg	Asymmetric	92 %	0.690	Bender Wirth: 437 Typ L1
CXM-14	Asym deg	Asymmetric	90 %	0.580	-
CLL03x/CLU034	Asymmetric deg	Asymmetric	92 %	0.616	Bender Wirth: 433 Typ L1
CXA/B 1816 & CXA/B 1820 & CXA 1850	Asym deg	Asymmetric	89 %	0.670	Bender Wirth: 437 Typ L1
LUXEON CoB 1208	Asymmetric deg	Asymmetric	-	0.300	-
CXA/B 1816 & CXA/B 1820 & CXA 1850	Asym deg	Asymmetric	87 %	0.670	-
Soleriq S19	Asymmetric deg	Asymmetric	90 %	0.500	-
Mega Zenigata (GW6DME)	Asym deg	Asymmetric	90 %	0.570	-

H G F E D C B A

Front view

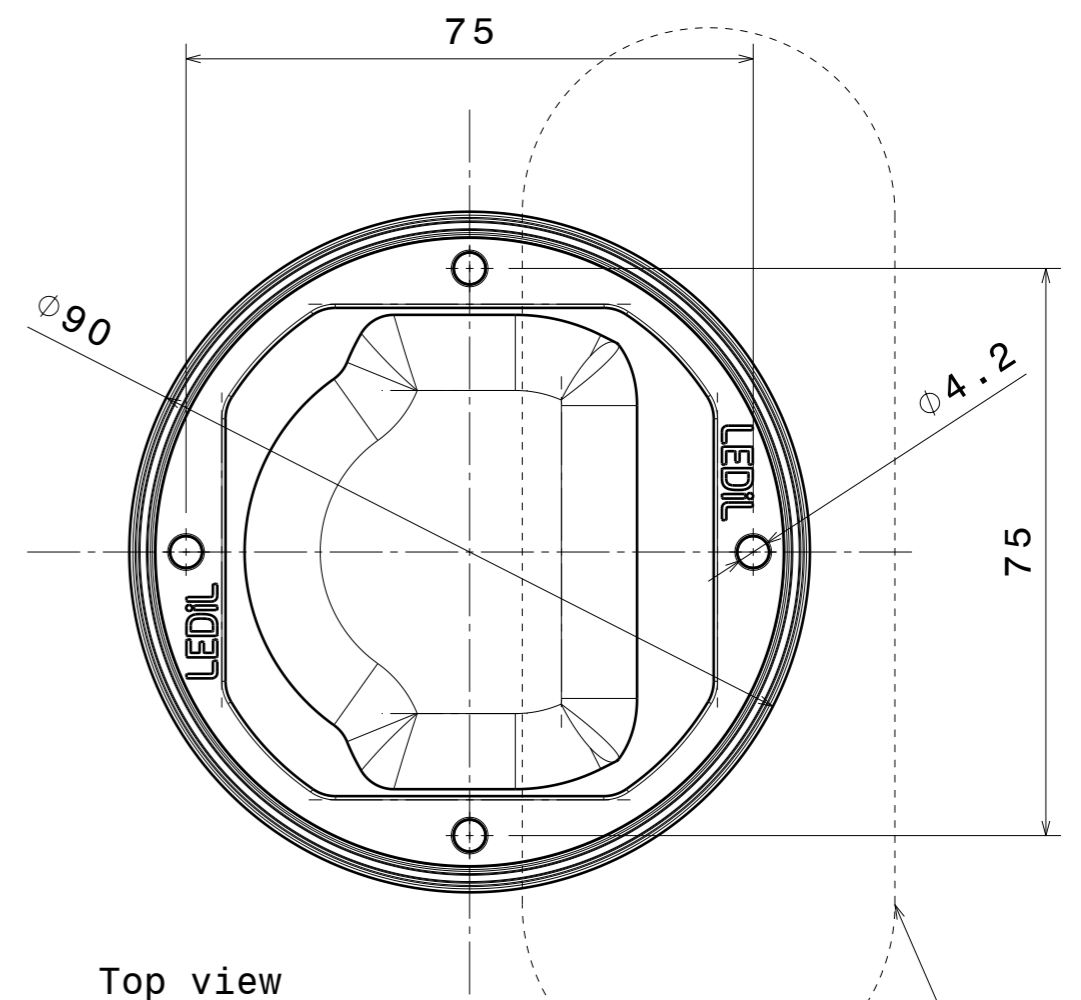
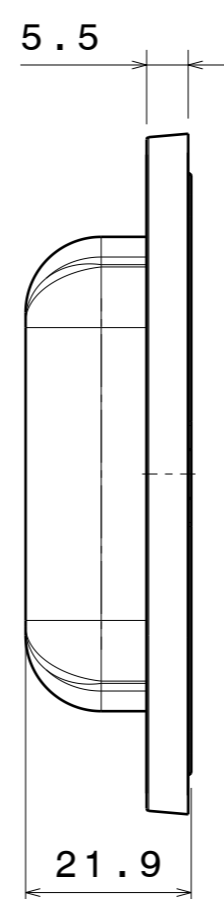
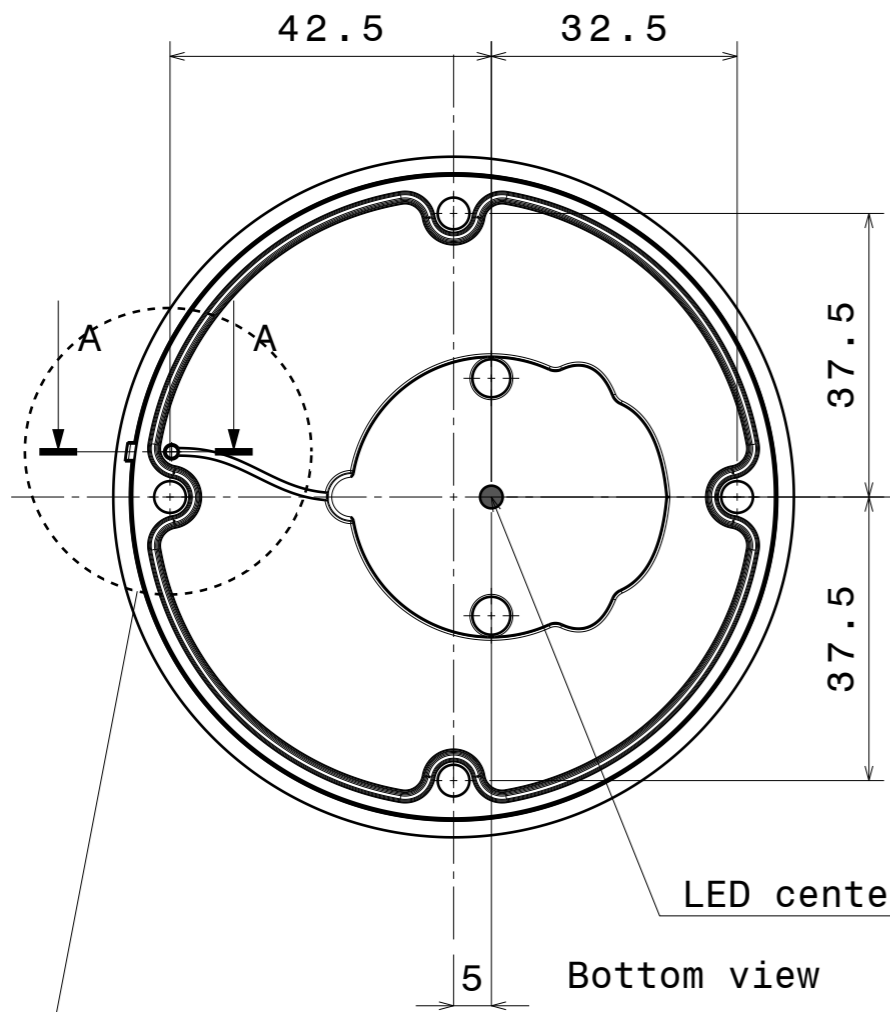

Top view

Light beam direction

Bottom view

Isometric view

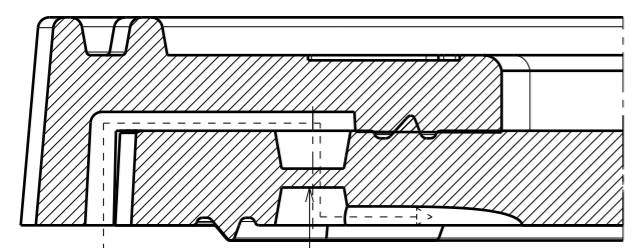

Section view A-A  
Scale: 5:1

Venting pipe:  
Piercing this membrane  
will Allow lens breathing

Lens material: Optical grade LSR  
Frame material: PA, black

<p>Tolerances if not otherwise shown According to DIN ISO 2768-1 Linear measures: class V Please note that due to the elasticity of products made of silicone actual measured values may vary, and therefore typical tolerance values may not be applied.</p>		<p><b>LEDiL</b> Ledi Oy Salorankatu 10 FIN 24240 SALO Finland</p>	
<p>THIRD ANGLE PROJECTION: </p>		<p>DRAWING TITLE <b>STELLA-A datasheet</b></p>	
<p>SIZE <b>A3</b></p>	<p>PART NUMBER <b>FN13323</b></p>		
<p>SCALE 1:1</p>	<p>WEIGHT (g)</p>	<p>SHEET 1/1</p>	

H G B A

Luminaire: LEDiL Oy FN13323\_STELLA-A (Luxeon\_CoB\_1203) (438\_Typ\_L1)  
Lamps: 1 x Luxeon\_CoB\_1203\_(LHC1-3080-1203)\_(438\_Typ\_L1)\_1005.18lm@250mA\_P=8.69829W\_I=0.2498A

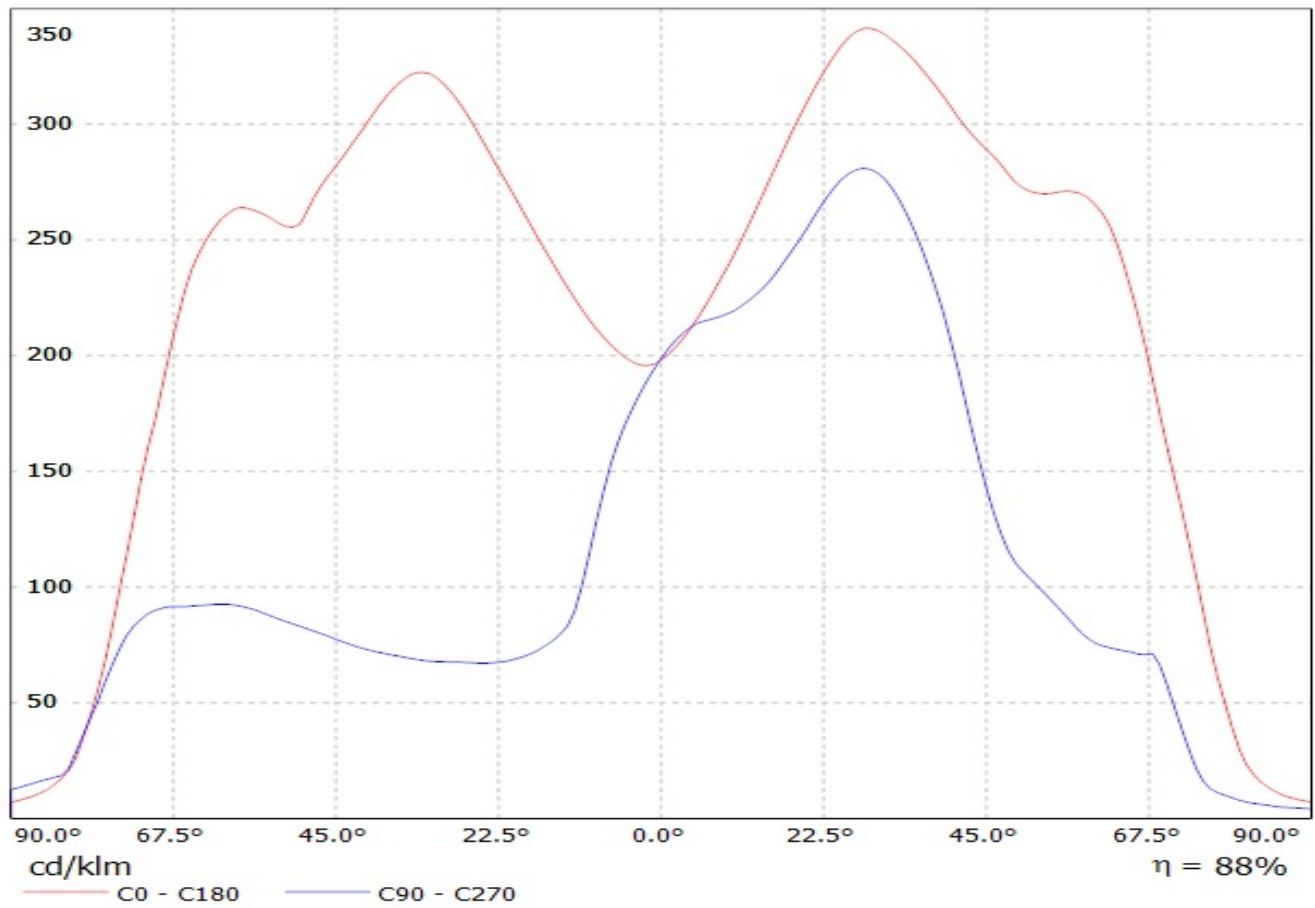

# Ledil FN13323\_STELLA-A\_(NFCLL036B) / LDC (Linear)

Luminaire: Ledil FN13323\_STELLA-A\_(NFCLL036B)  
Lamps: 1 x Nichia\_NFCLL036B\_(SM403J1300R8000)  
\_563.488lm@100mA\_CCT=4000K\_P=3.35W\_I=0.100A

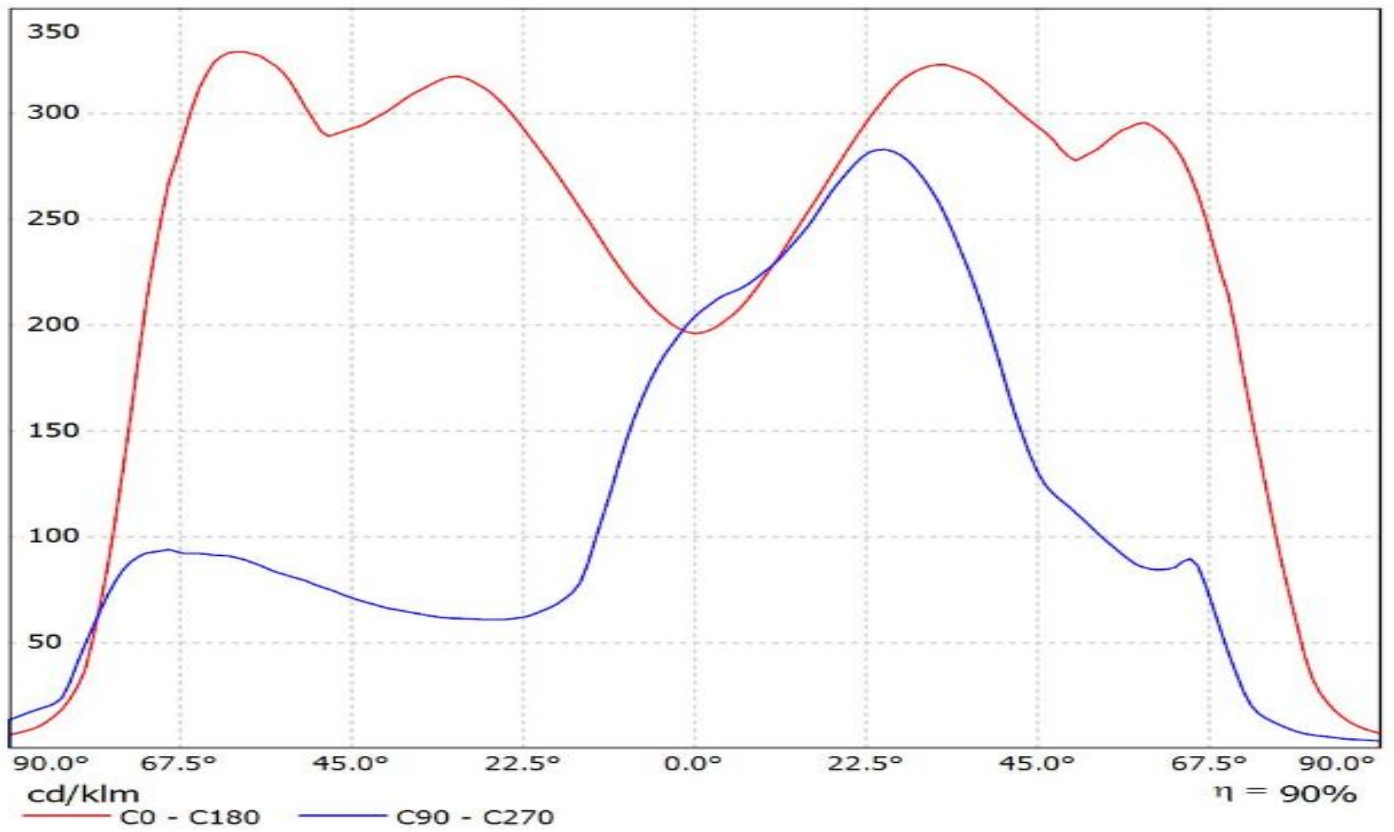

Luminaire: LEDiL Oy FN13323\_STELLA-A\_(CXM-18) Eff.89.2%  
Lamps: 1 x LUMINUS\_XNOVA\_CXM-18\_897.842lm@250mA\_P=8.12425W\_I=249.9mA

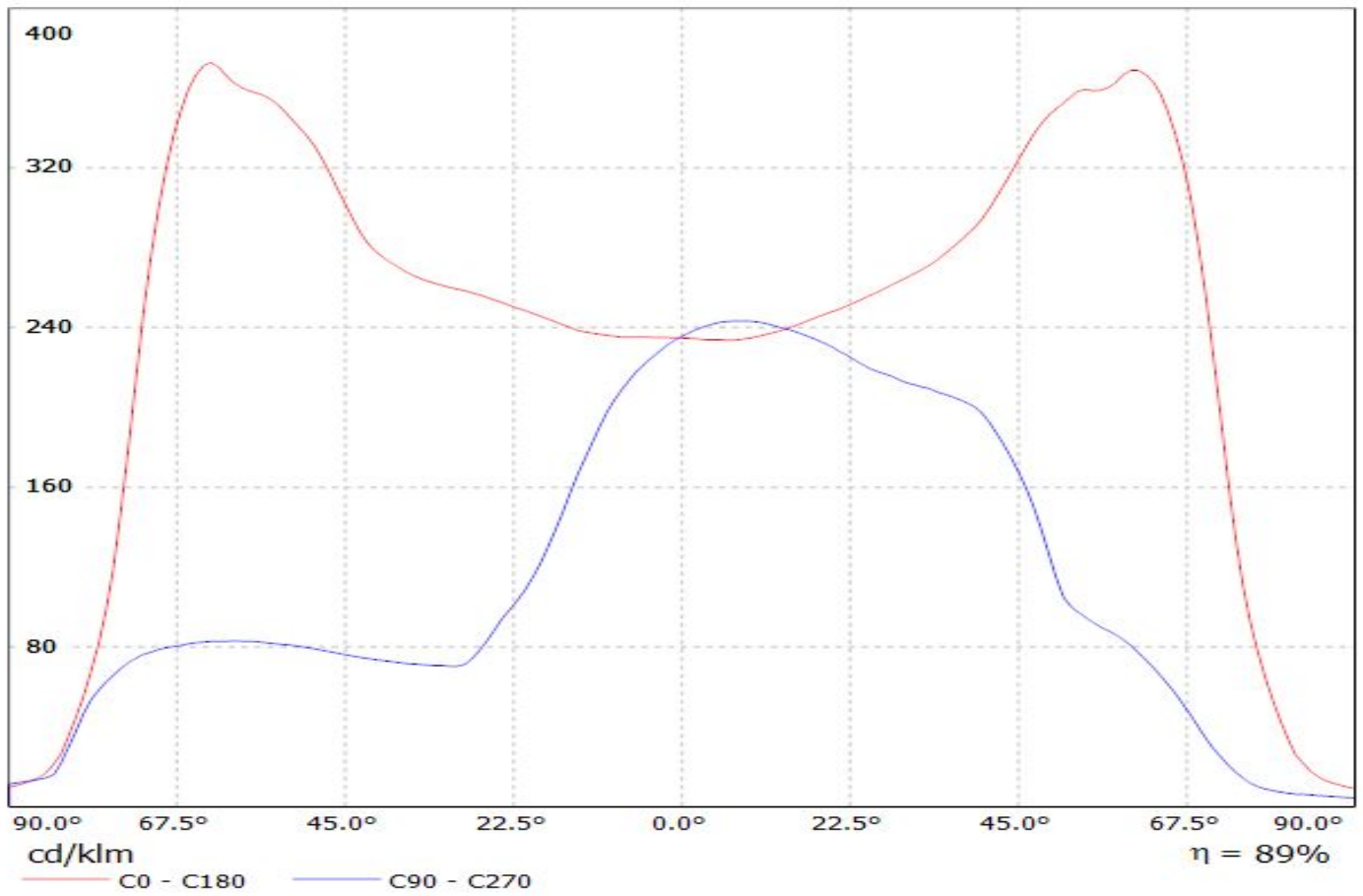

Luminaire: LEDiL Oy FN13323\_STELLA-A\_(V15)

Lamps: 1 x Bridgelux\_V15\_1050.21lm@250mA\_P=8.19169W\_I=249.8mA

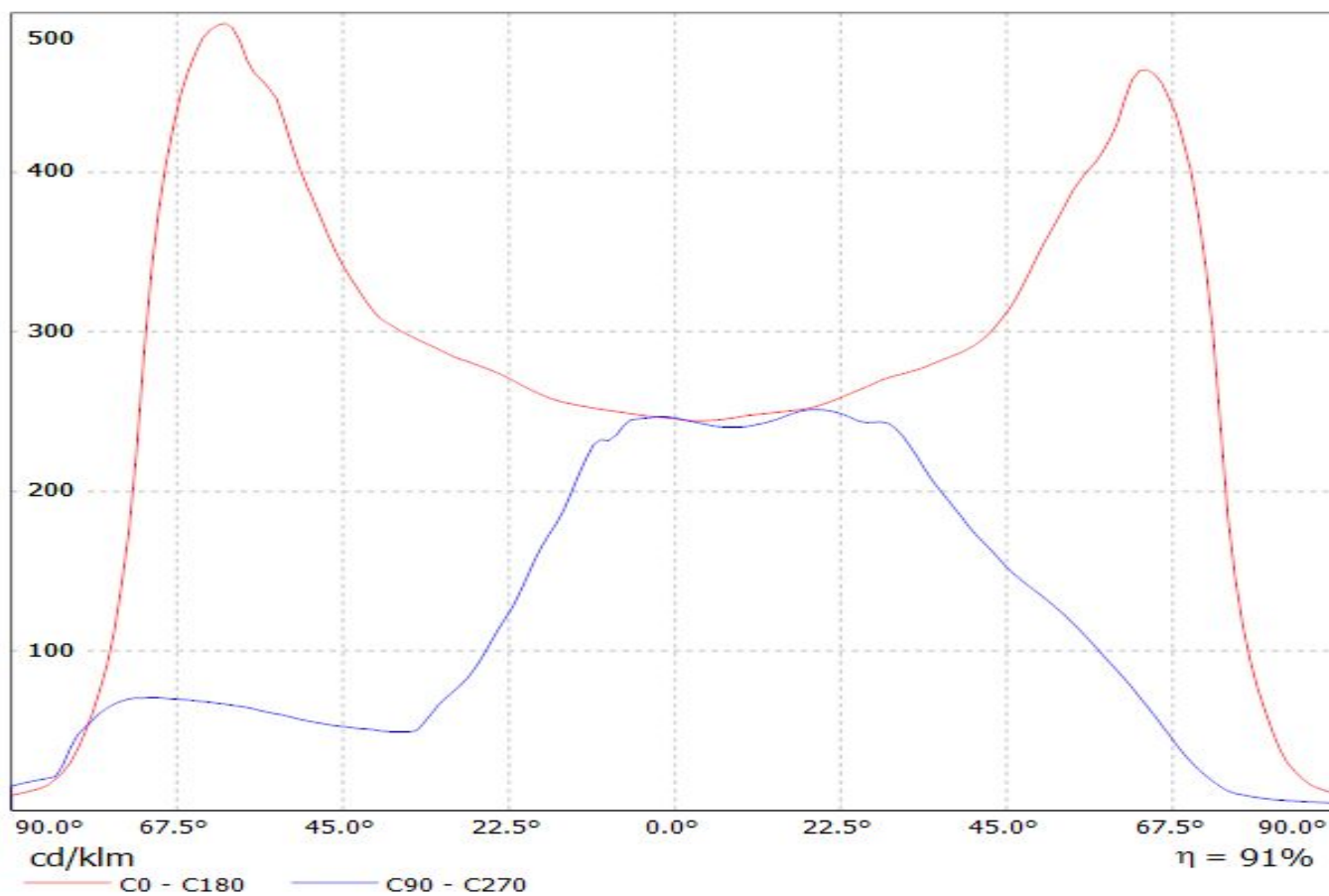

Luminaire: LEDiL Oy FN13323\_STELLA-A\_(SOLERIQ\_P13)

Lamps: 1 x SOLERIQ\_P13\_(GW\_MAGMB1.EM)\_929.576lm@250mA\_CCT=3500K\_P=8.72876W\_I=249.8mA

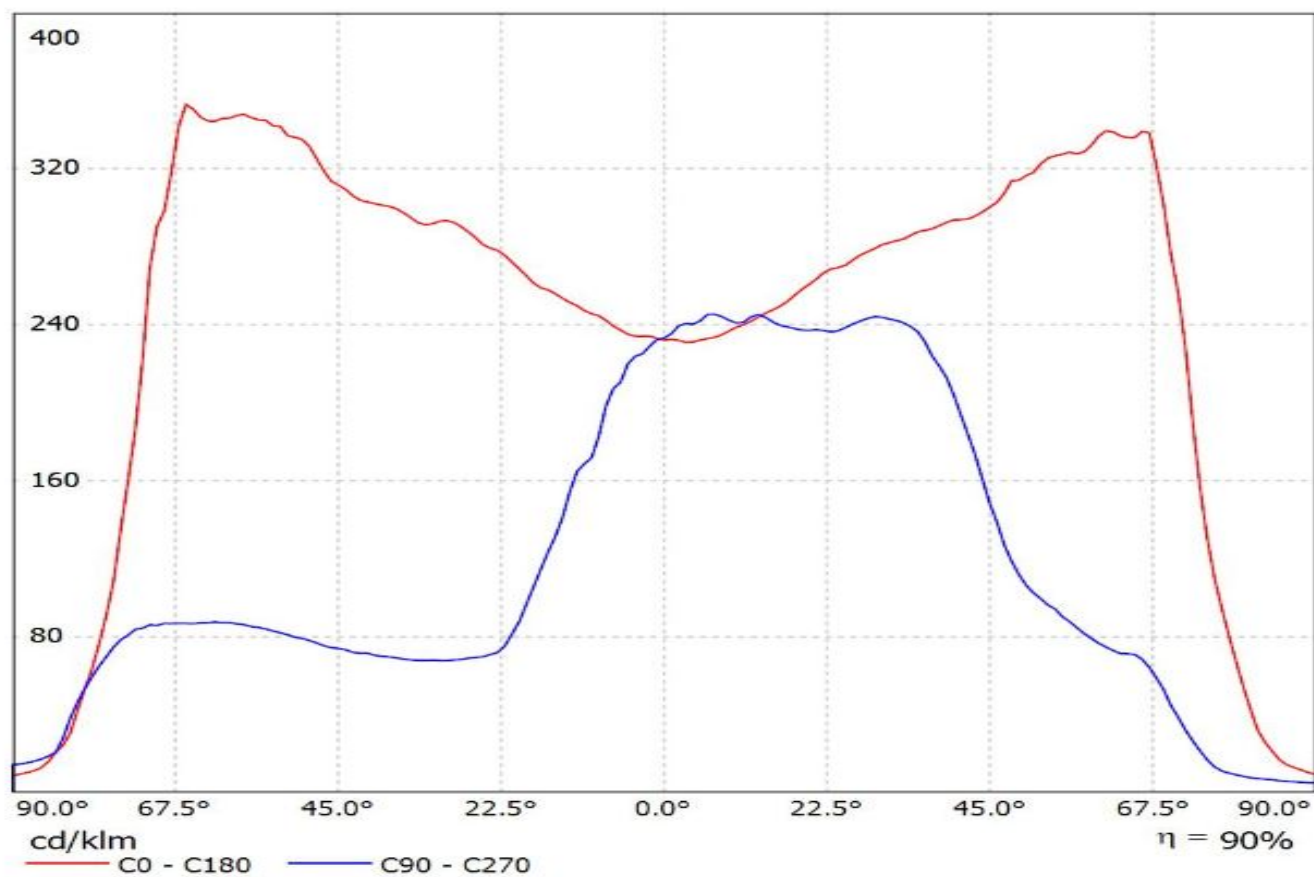

Luminaire: Ledil FN13323\_STELLA-A\_(CXA1520)\_(441\_Typ\_L1) Citizen\_CXA1520\_(CXA1520-30F-N4-N0H-00001)\_(441\_Typ\_L1)\_1038.48lm@250mA\_P=8.8025W\_I=0.25A  
Lamps: 1 x Citizen\_CXA1520\_(CXA1520-30F-N4-N0H-00001)\_(441\_Typ\_L1)  
\_1038.48lm@250mA\_P=8.8025W\_I=0.25A

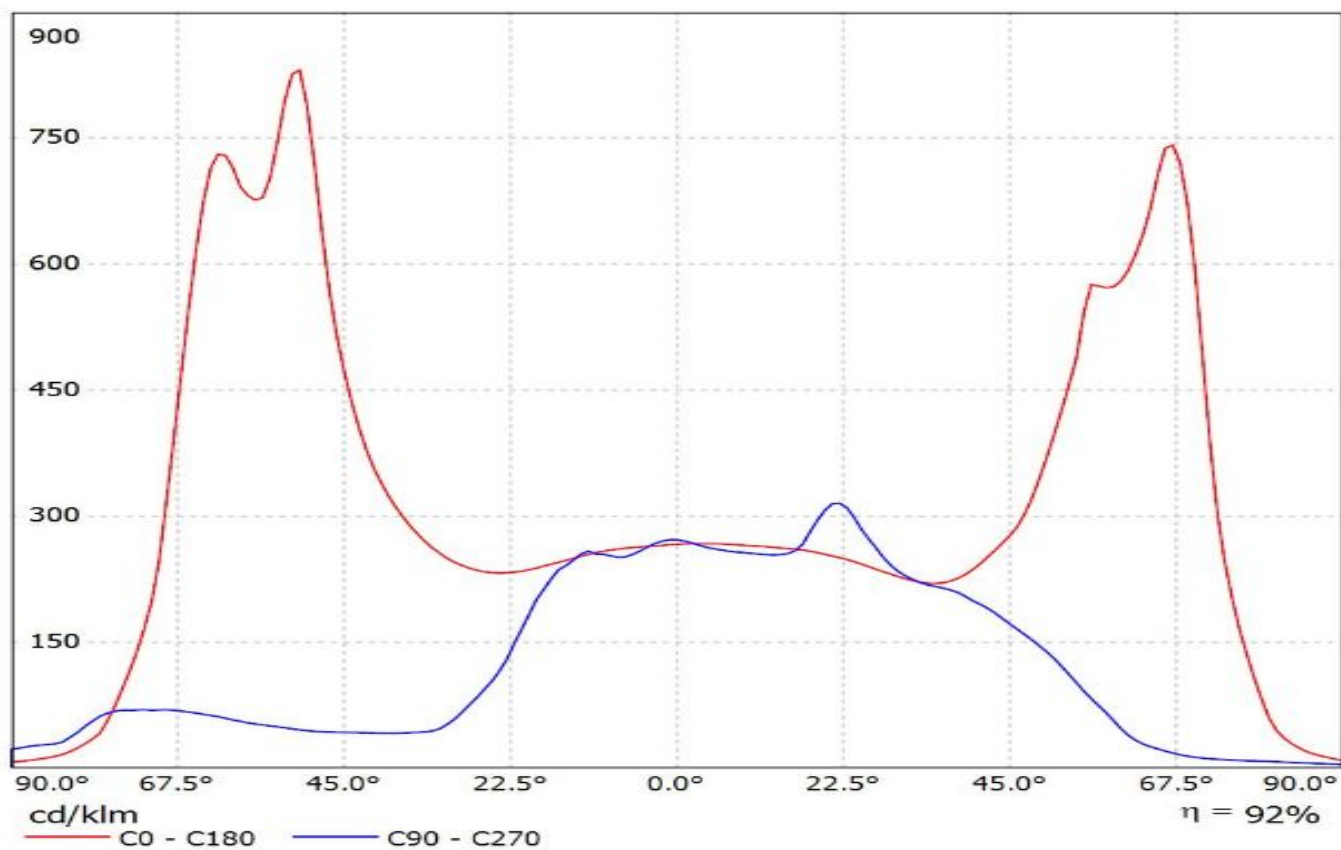



Luminaire: LEDiL Oy FN13323\_STELLA-A\_(CXA25) Eff. 93%  
Lamps: 1 x CREE\_CXA25 (CXA2530-7C0-T2-N0H)1100lm@250mA CCT=3000K P=8W I=250mA

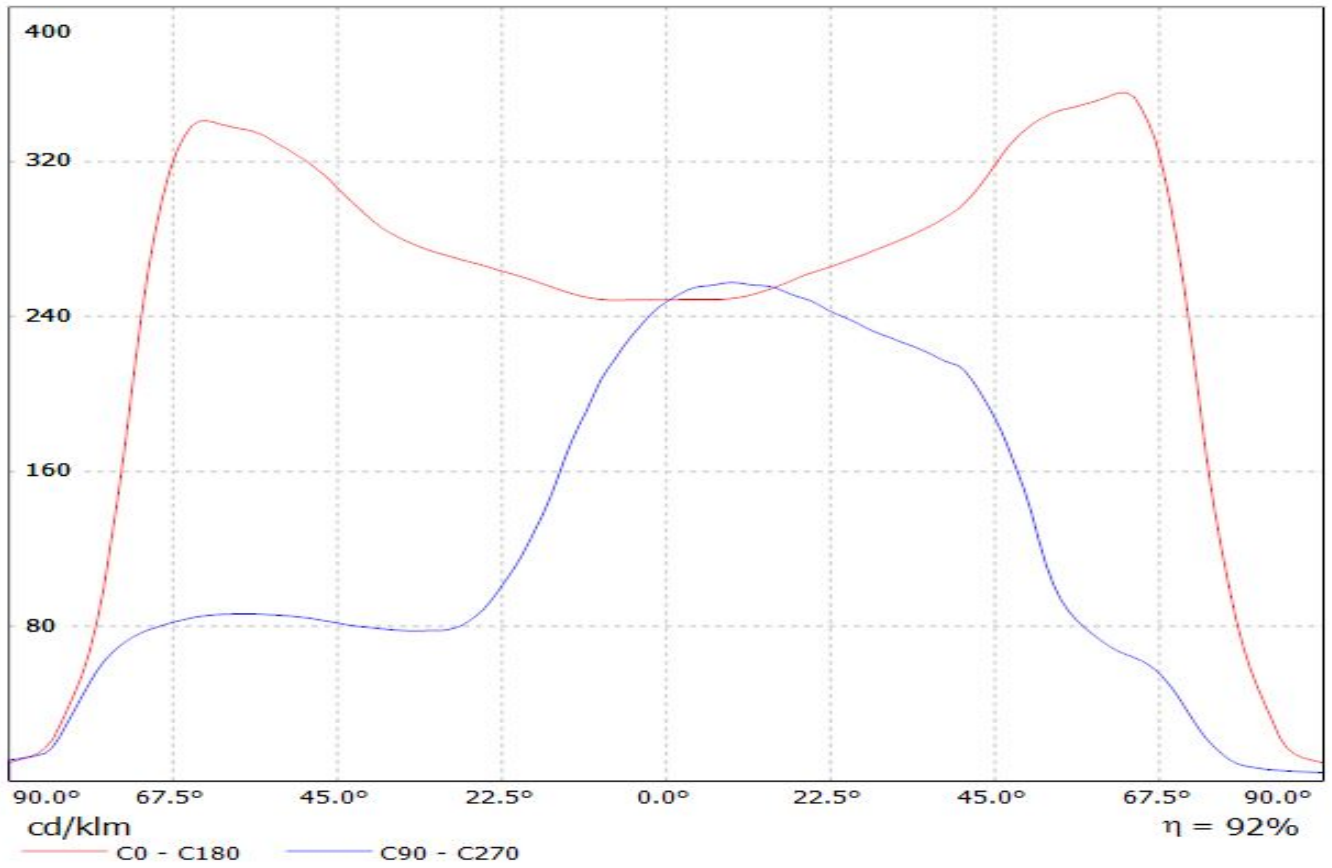

Luminaire: LEDiL Oy FN13323\_STELLA-A\_(CXA1507) Eff: 92%  
Lamps: 1 x Cree\_CXA1507\_(CXA1507-30F-F2-N0A-0000) 220lm@50mA CCT=3000K P=2W I=50mA

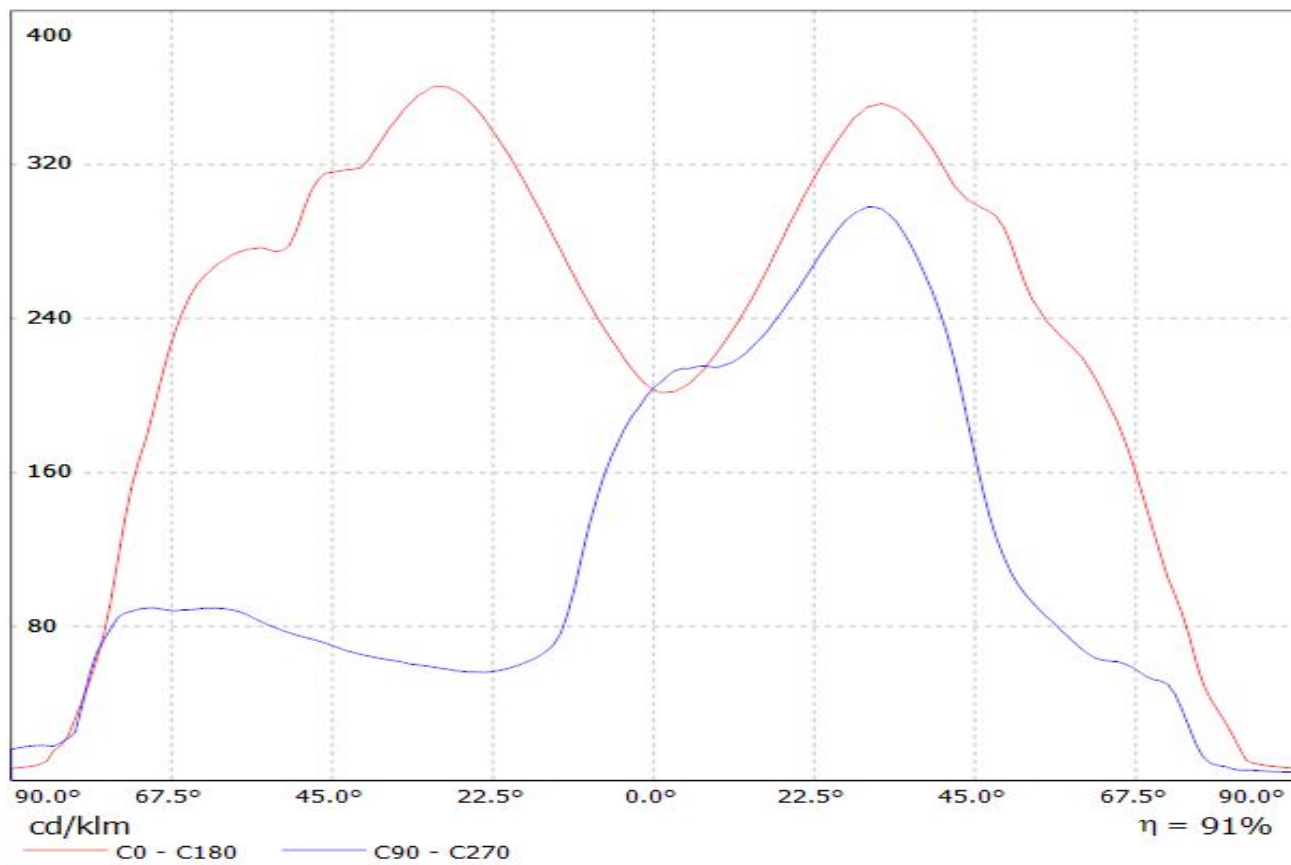

Luminaire: LEDiL Oy FN13323\_STELLA-A\_(Soleriq\_S13)

Lamps: 1 x Osram\_Soleriq\_S13\_802.964lm@250mA\_CCT=3125K\_P=7.26069W\_I=249.8mA

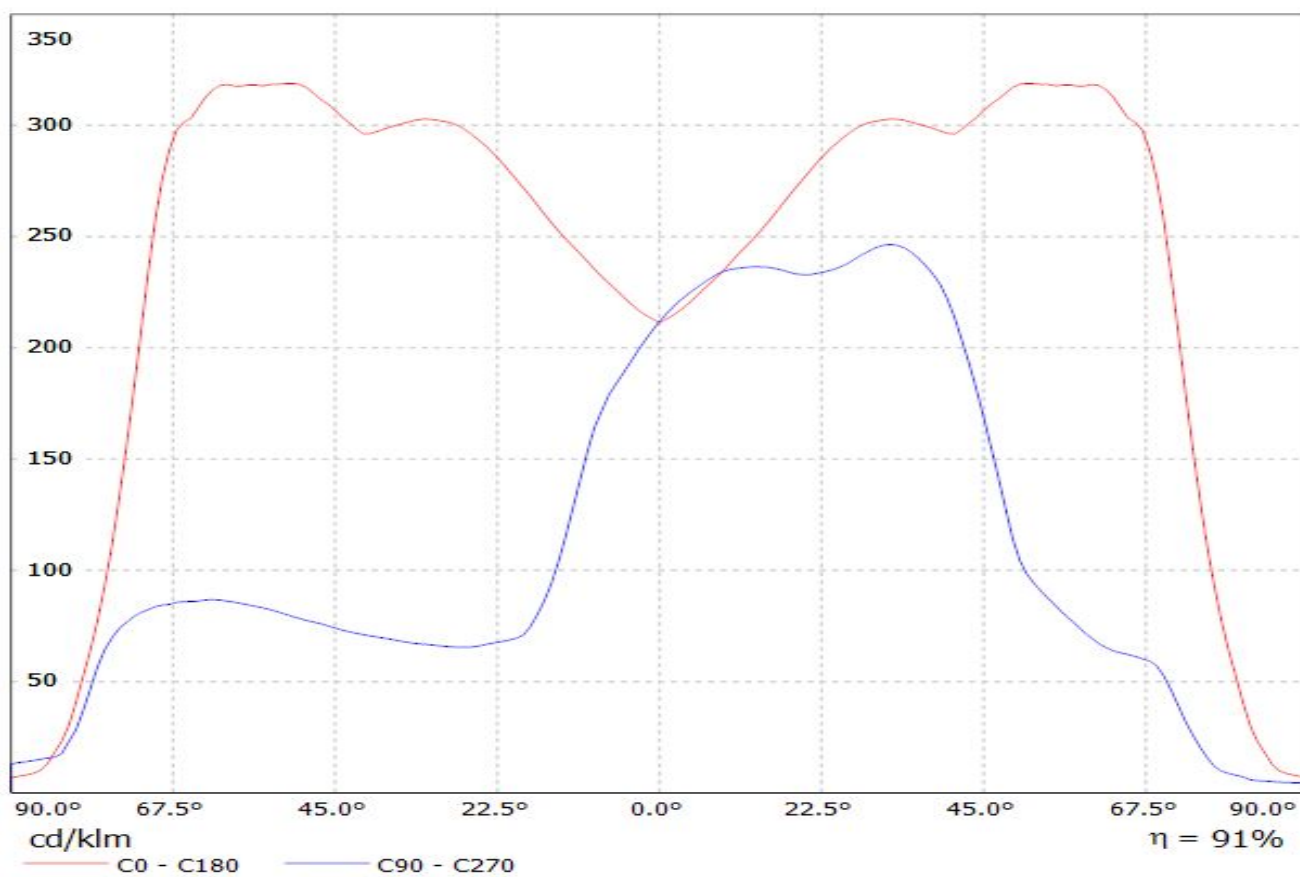

Luminaire: Ledil FN13323\_STELLA-A\_(CLU710)

Lamps: 1 x CITIZEN\_CLU710\_(CLU710-1204B8-273M2G1)\_1212.66lm@250mA\_P=8.5W\_I=0.25A

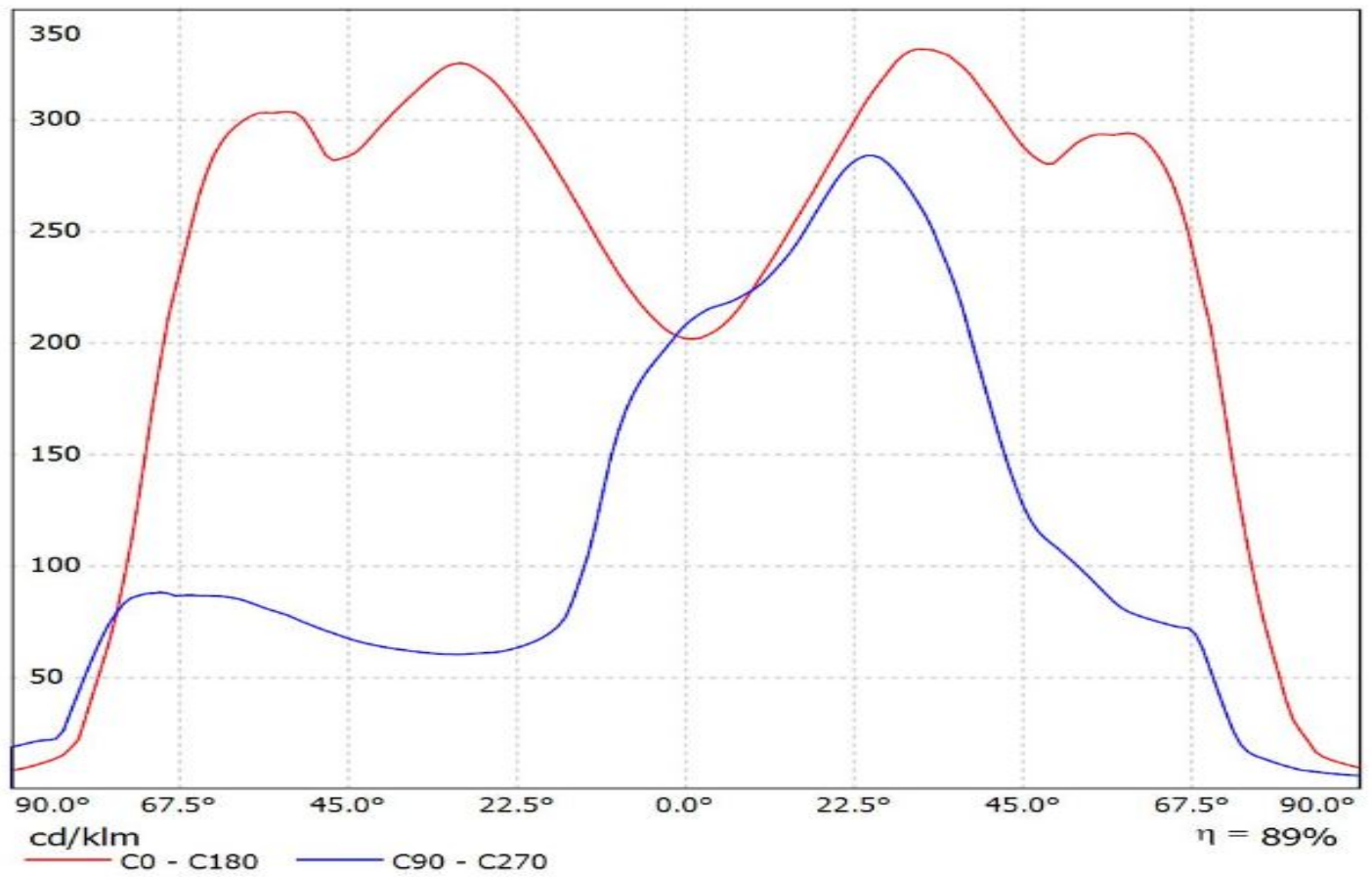

# Ledil FN13323\_STELLA-A\_(CLU720) / LDC (Linear)

Luminaire: Ledil FN13323\_STELLA-A\_(CLU720)  
Lamps: 1 x CITIZEN\_CLU720\_(CLU720-1206B8-273M2)  
\_1298.17lm@250mA\_CCT=2700K\_P=8.3W\_I=0.25A

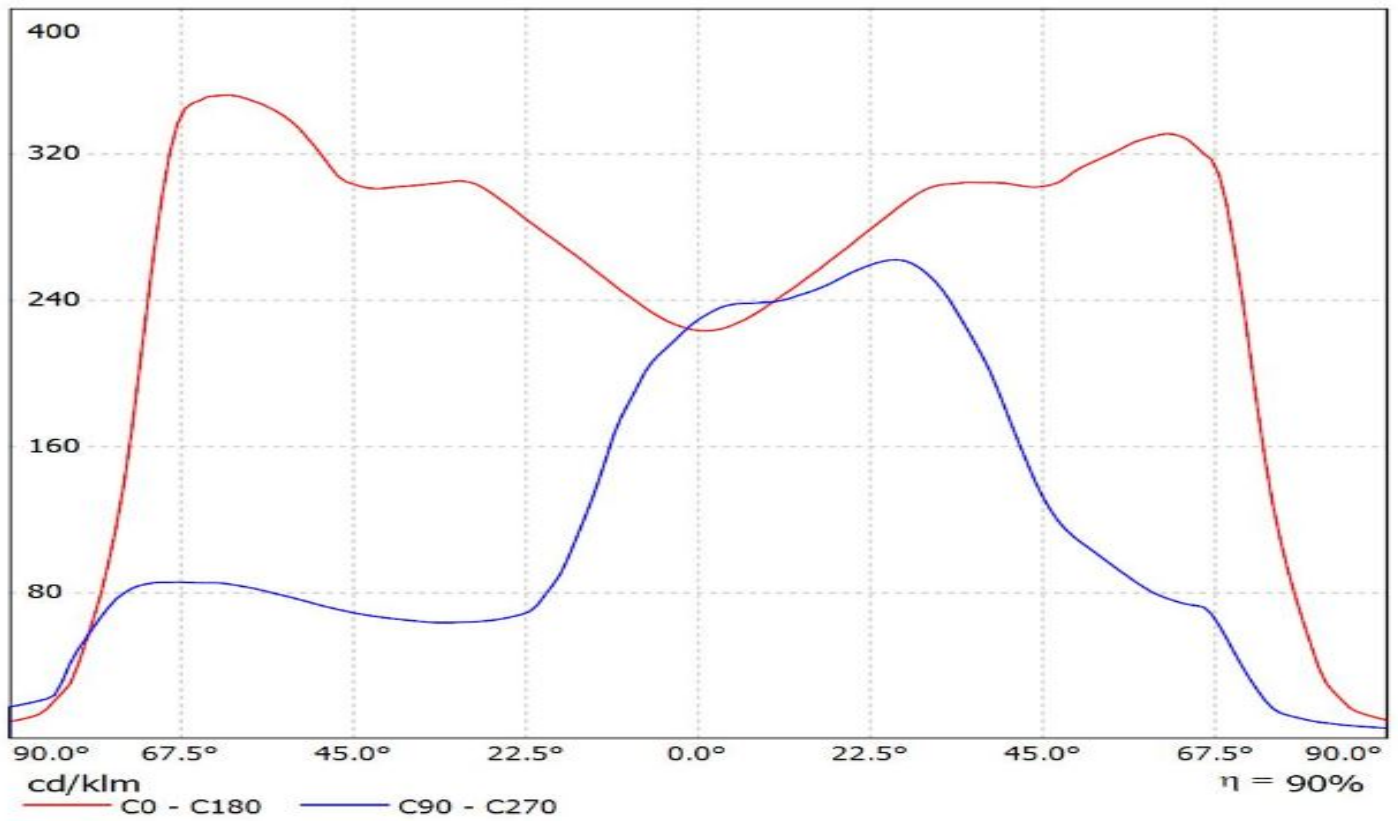

Luminaire: Ledil FN13323\_STELLA-A\_(CLU700)\_(434\_Typ\_L1)

Lamps: 1 x Citizen\_CLU700\_(CLU700-1002B8-273M2G1)\_(434\_Typ\_L1)\_390.128lm@100mA\_P=3W\_I=0.10A

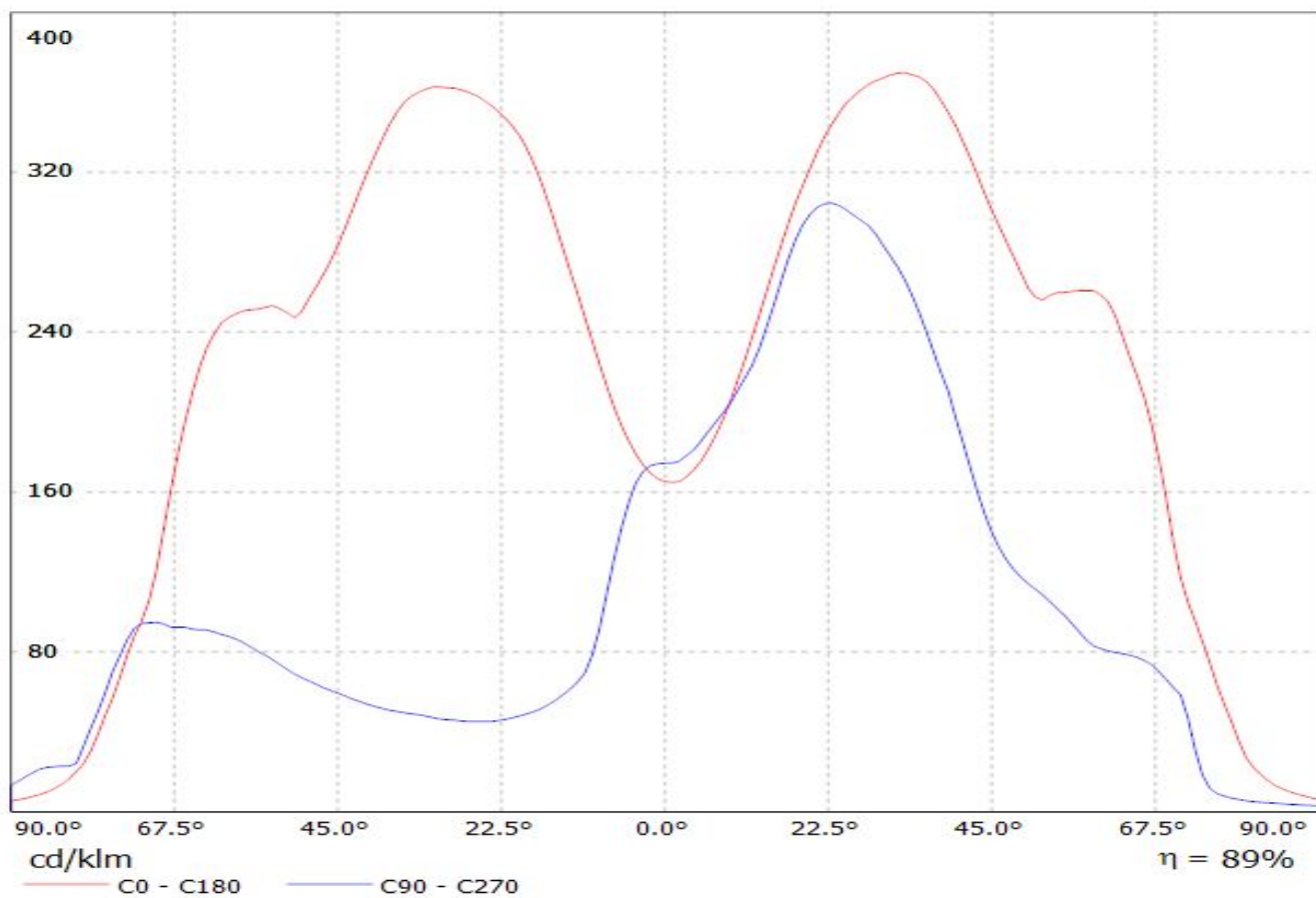

Luminaire: Ledil FN13323\_STELLA-A\_(CLU720)\_(433\_Typ\_L1)

Lamps: 1 x Citizen\_CLU720\_(CLU720-1206B8-273M2G1)\_1204.28lm@250mA\_P=8.25W\_I=0.25A

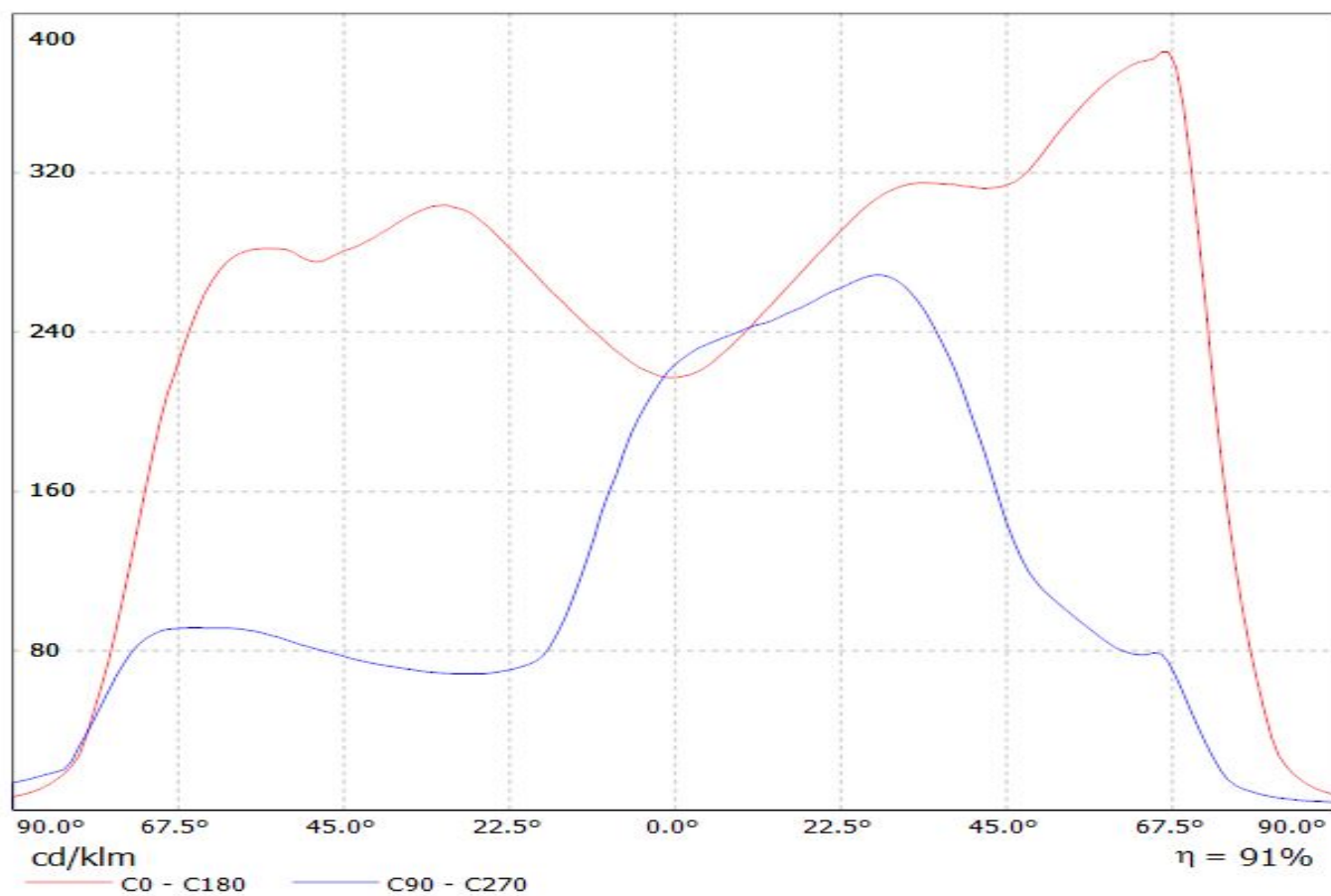

Luminaire: LEDiL Oy FN13323\_STELLA-A Eff. 92%  
Lamps: 1 x VERO13 (BXRC-30E4000F) 819lm@250mA CCT=3000K P=7.5W I=250mA

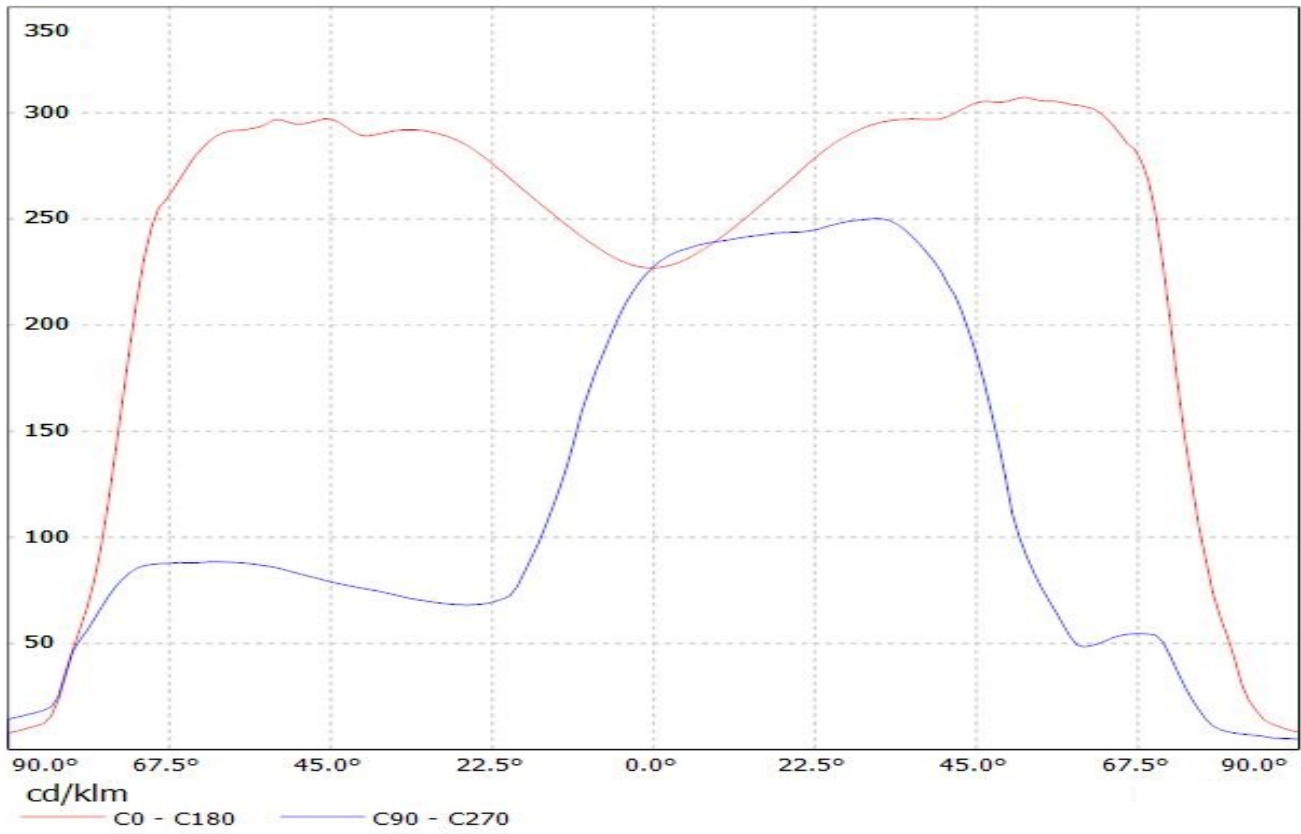



Luminaire: LEDiL Oy FN13323\_STELLA-A (VERO18) Eff. 92%  
Lamps: 1 x VERO18 (BXRC-30E4000F)786lm@250mA CCT=3000K P=6.84W I=250mA

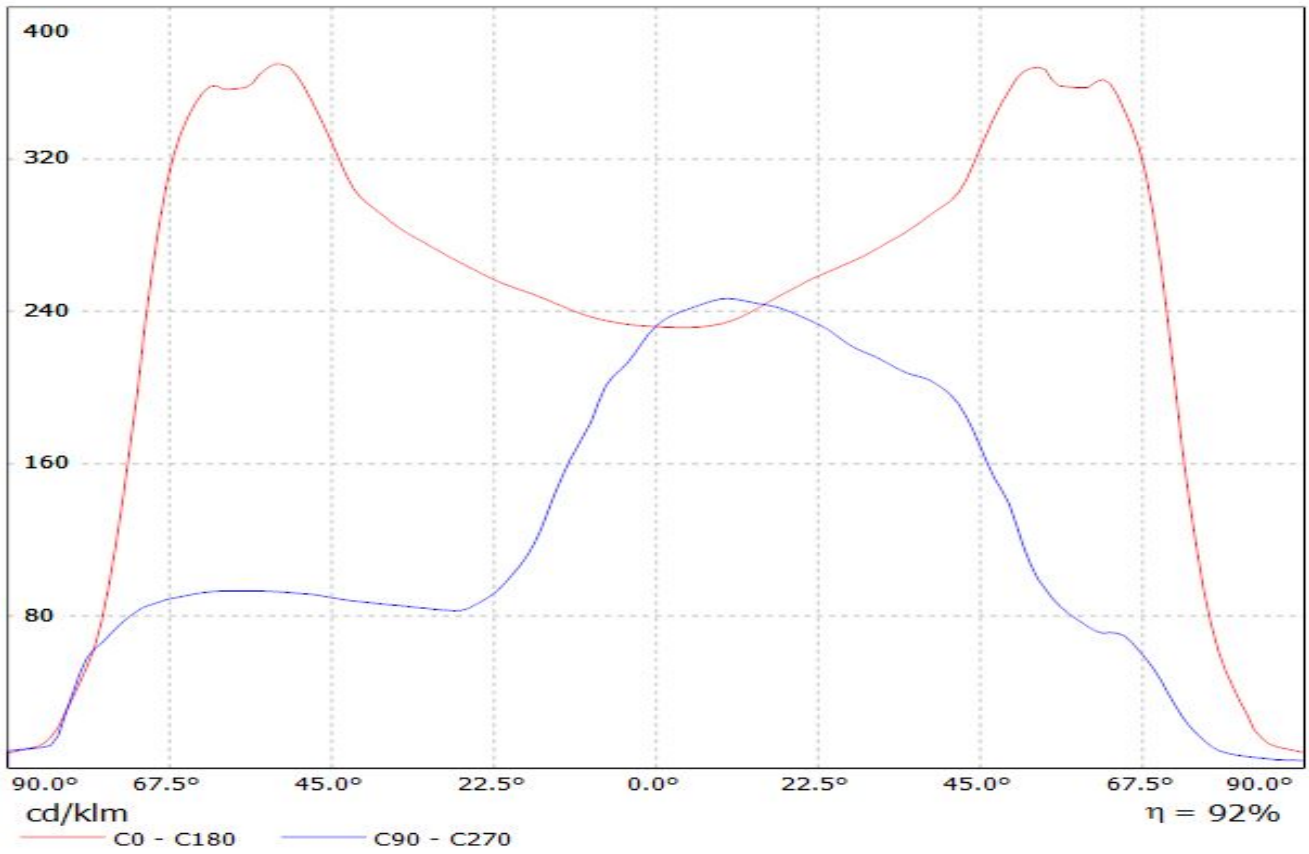

# Ledil FN13323\_STELLA-A\_(P13) / LDC (Linear)

Luminaire: Ledil FN13323\_STELLA-A\_(P13)  
Lamps: 1 x Osram Soleriq P13 (GW MAGMB1.EM)  
\_929.576lm@250mA\_CCT=3500K\_P=8.72876W\_I=249.8mA

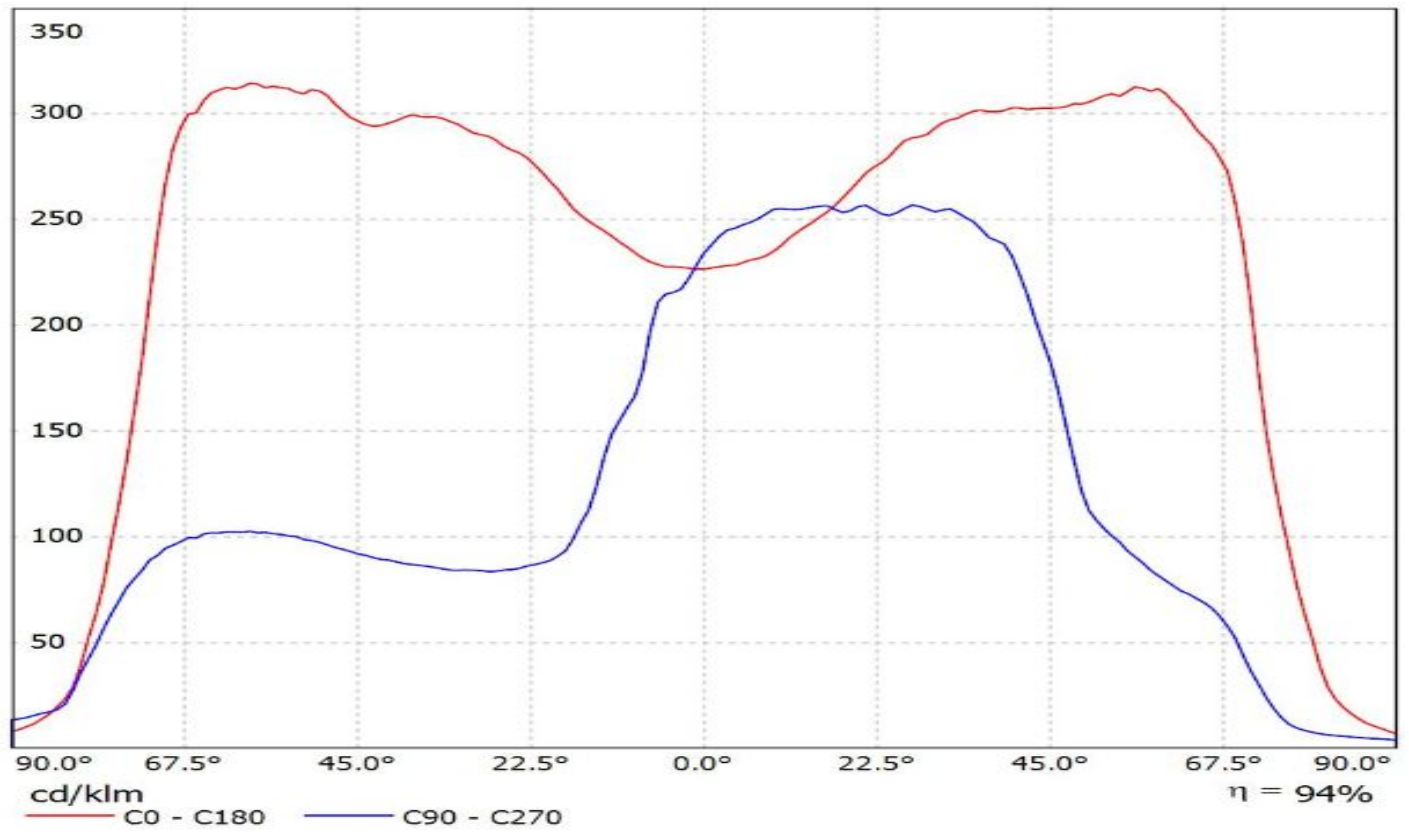

# Ledil FN13323\_STELLA-A\_(Soleriq\_S13) / LDC (Linear)

Luminaire: Ledil FN13323\_STELLA-A\_(Soleriq\_S13)

Lamps: 1 x Osram\_Soleriq\_S13\_(GW\_KAGHB1.EM)\_875.214lm@250mA\_P=7.44679W\_I=250mA

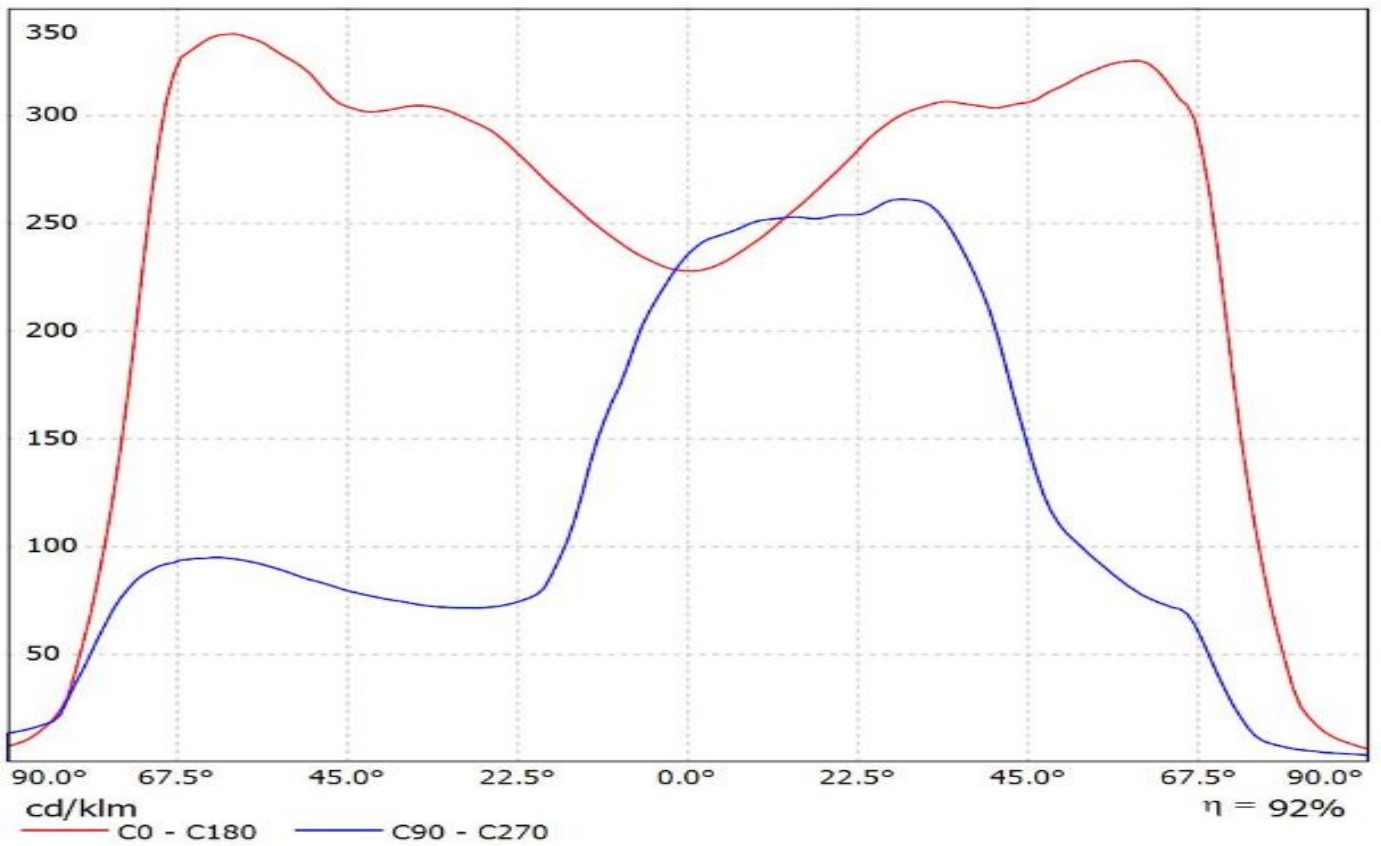

Luminaire: LEDiL Oy FN13323\_STELLA-A\_(CXM-14)  
Lamps: 1 x LUMINUS\_XNOVA\_CXM-14\_(AC00)  
\_1064.17lm@250mA\_CCT=3133K\_P=8.33558W\_I=249.8mA

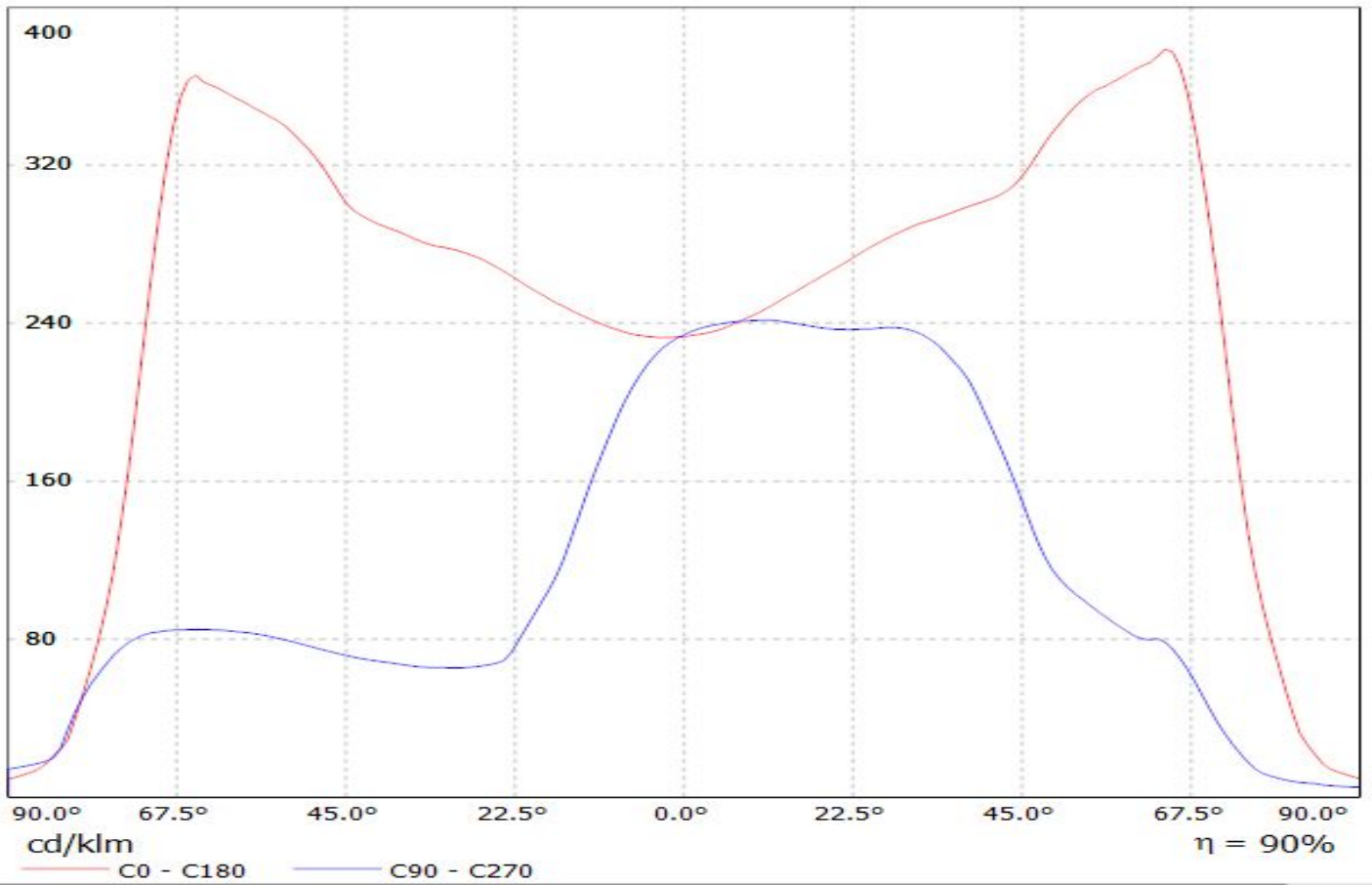

Luminaire: LEDiL Oy FN13323\_STELLA-A\_(CLL030) Eff. 92%

Lamps: 1 x Citizen\_CLL030\_(CLL030-1205A5-303H1A7) 690lm@250mA CCT=3000K P=9W I=250mA

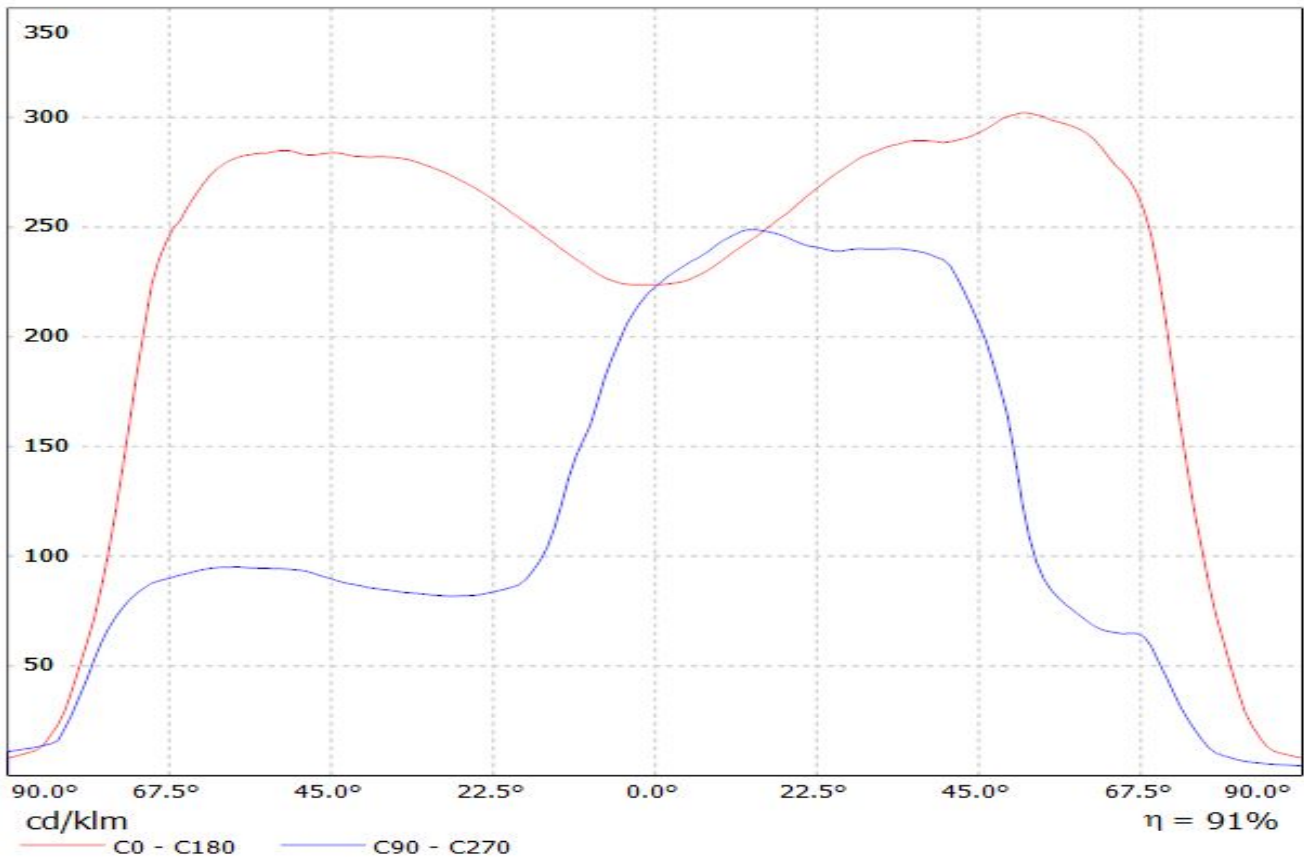

# Ledil FN13323\_STELLA-A\_(CXA1850) / LDC (Linear)

Luminaire: Ledil FN13323\_STELLA-A\_(CXA1850)  
Lamps: 1 x CREE\_CXA1850\_(CXA1850-30F-T4-N0Y-00001)  
\_837.004lm@250mA\_CCT=3000K\_P=8.24W\_I=0.25A

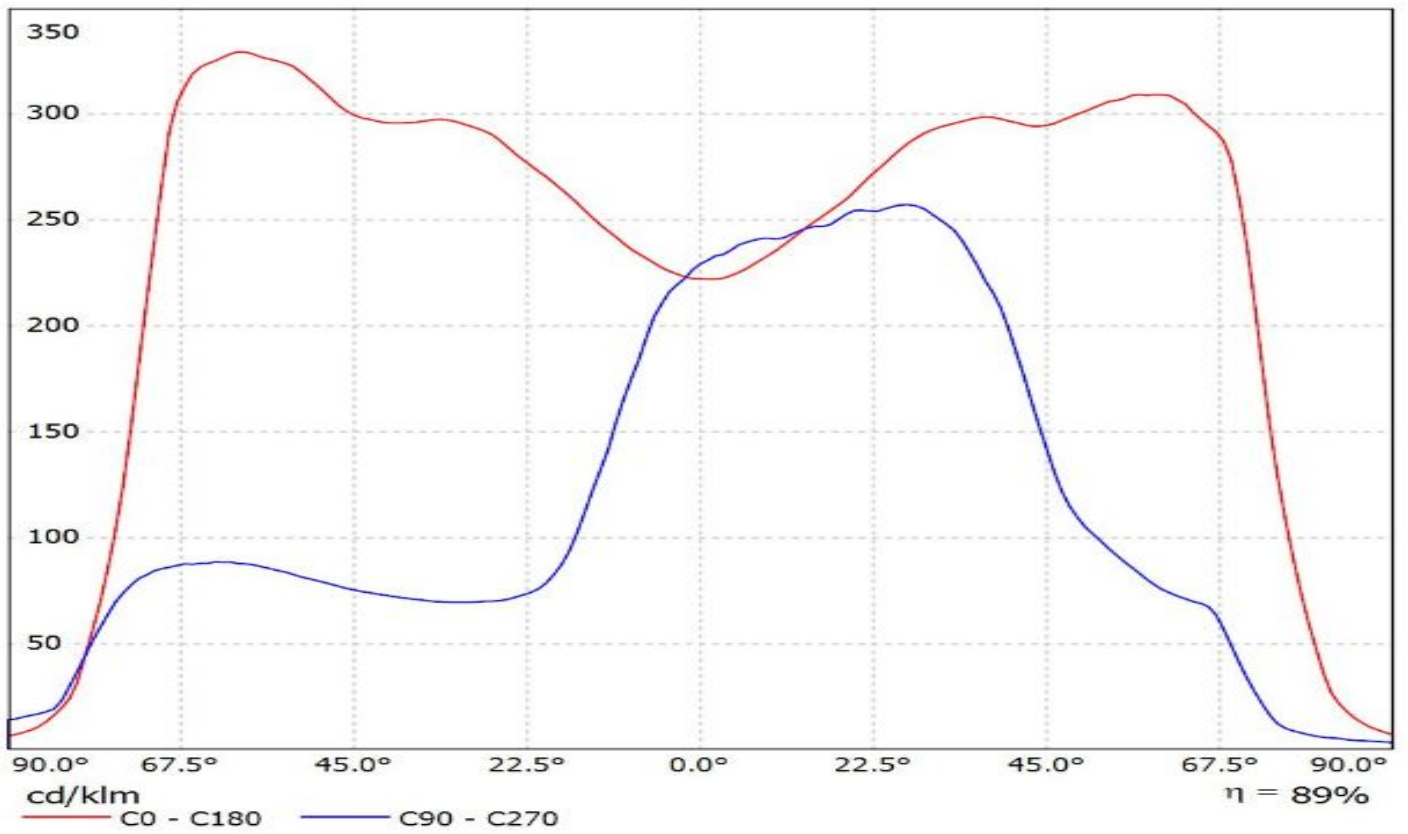

# LEDiL Oy FN13323\_STELLA-A\_(CXA1816) Eff.87.1% / LDC (Linear)

Luminaire: LEDiL Oy FN13323\_STELLA-A\_(CXA1816) Eff.87.1%  
Lamps: 1 x CREE\_CXA1816\_1075.33lm@250mA\_P=8.66981W\_I=249.8mA

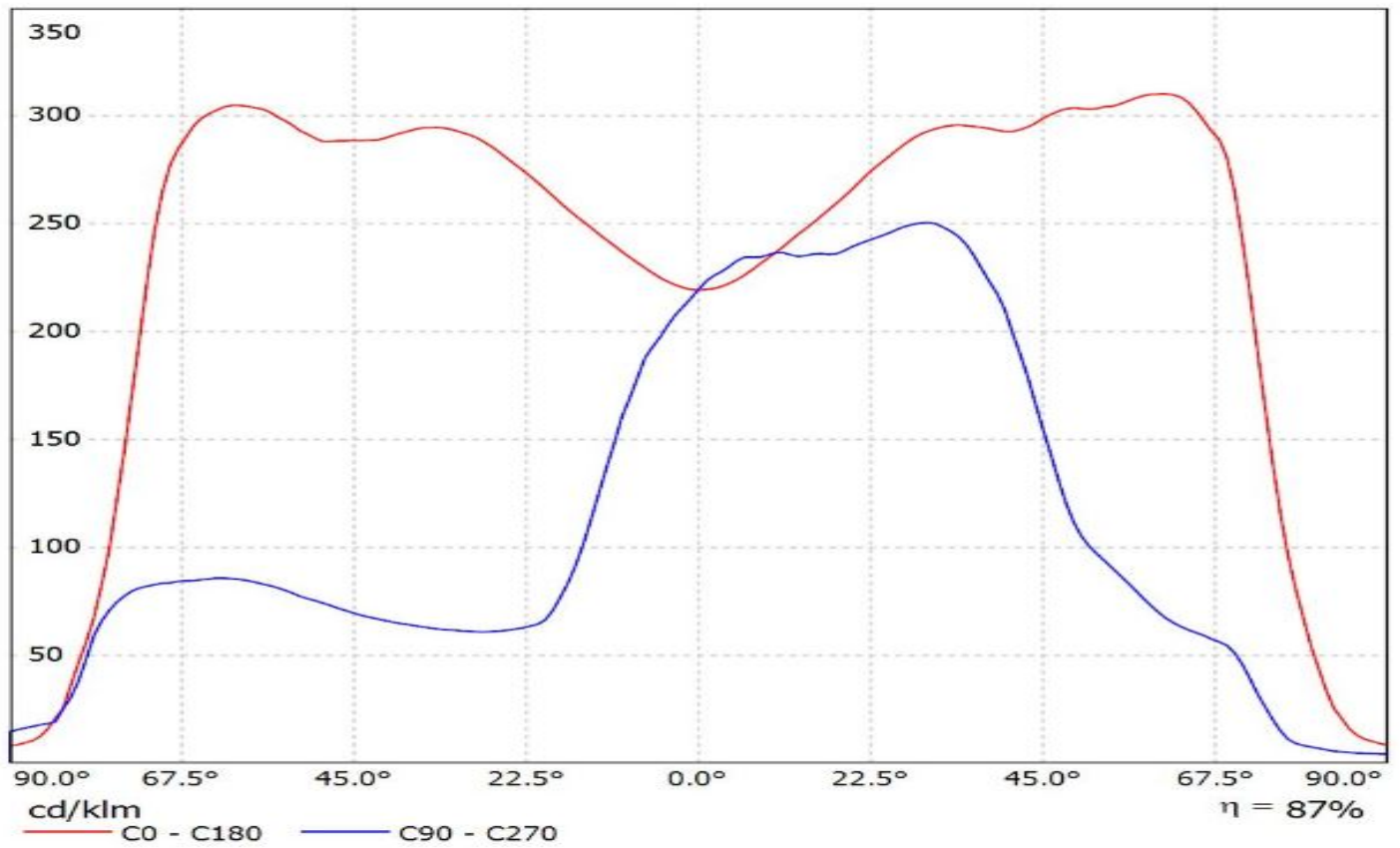

Luminaire: LEDiL Oy FN13323\_STELLA-A\_(SOLERIQ\_S19)

Lamps: 1 x OSRAM\_SOLERIQ\_S19\_(GW\_KAHJB1.EM)\_1340.3lm@250mA\_CCT=3000K\_P=10.4491W\_I=249.8mA

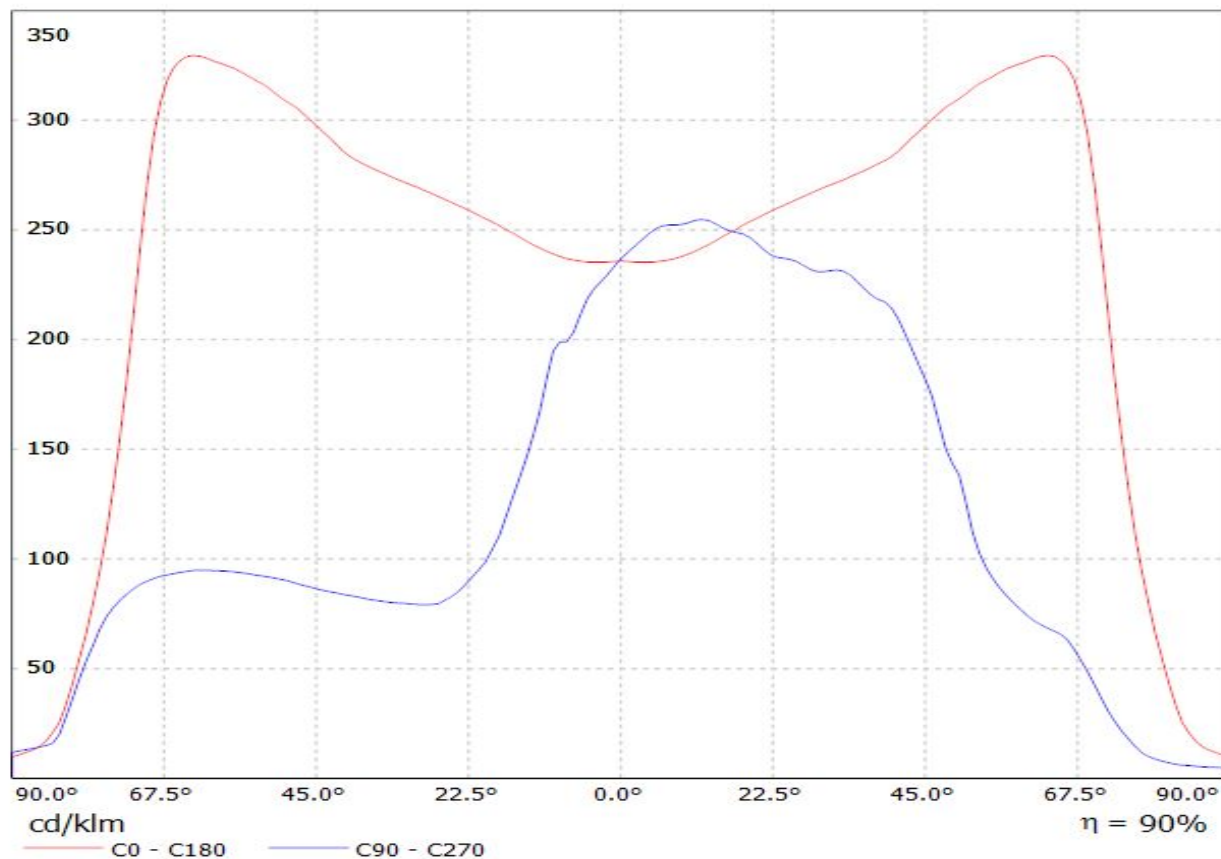



Luminaire: LEDiL Oy FN13323\_STELLA-A (Megazenigata\_GW6D) Eff.89.9%  
Lamps: 1 x SHARP\_Megazenigata\_(GW6DMC40NFC)\_1072.13lm@250mA\_P=8.51443W\_I=249.8mA

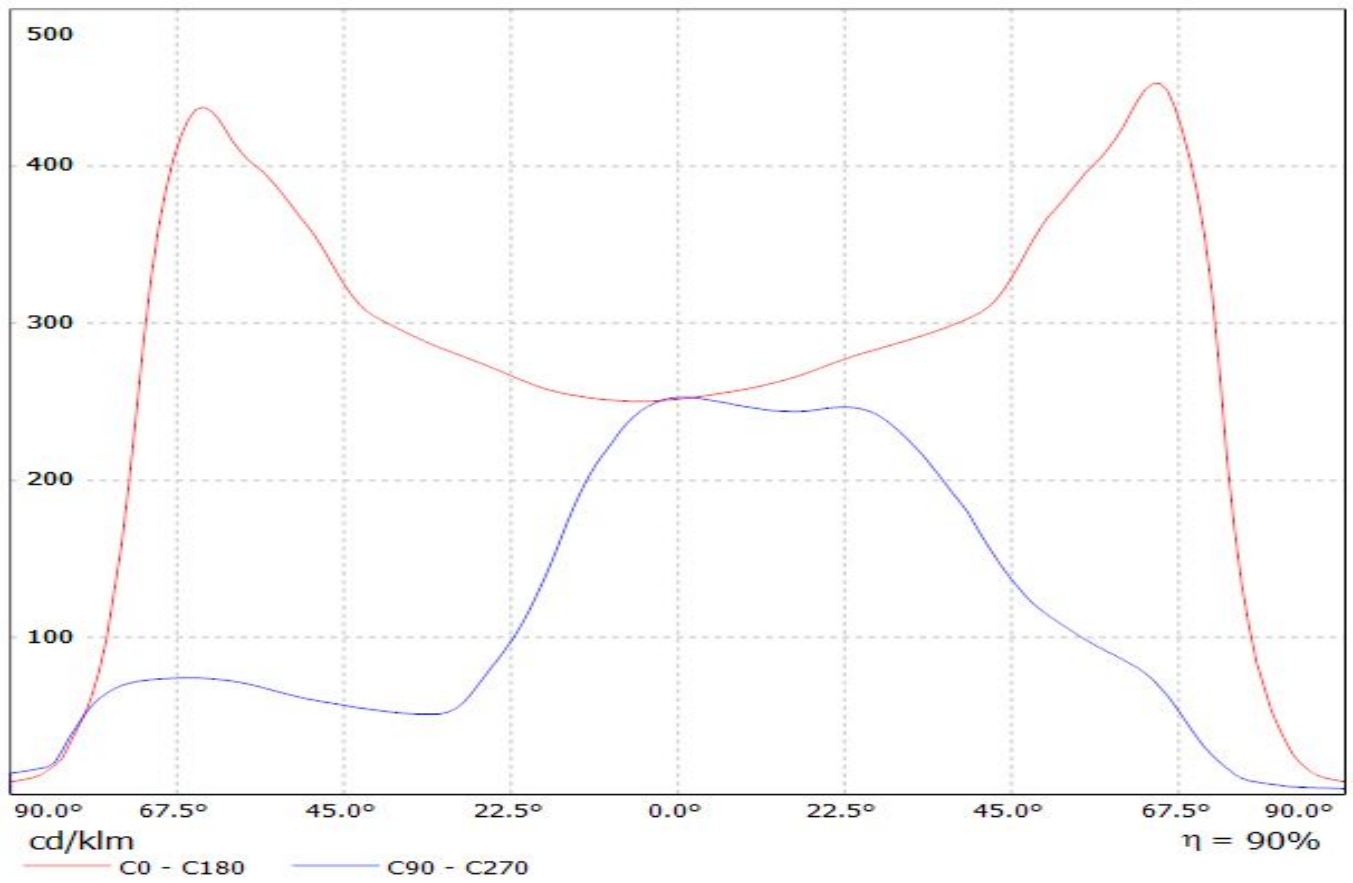

# Ledil FN13323\_STELLA-A\_(NFCLL060B) / LDC (Linear)

Luminaire: Ledil FN13323\_STELLA-A\_(NFCLL060B)

Lamps: 1 x Nichia\_NFCLL060B\_(sm406G2450R8000)\_1368.94lm@250mA\_P=8.5W\_I=0.25A

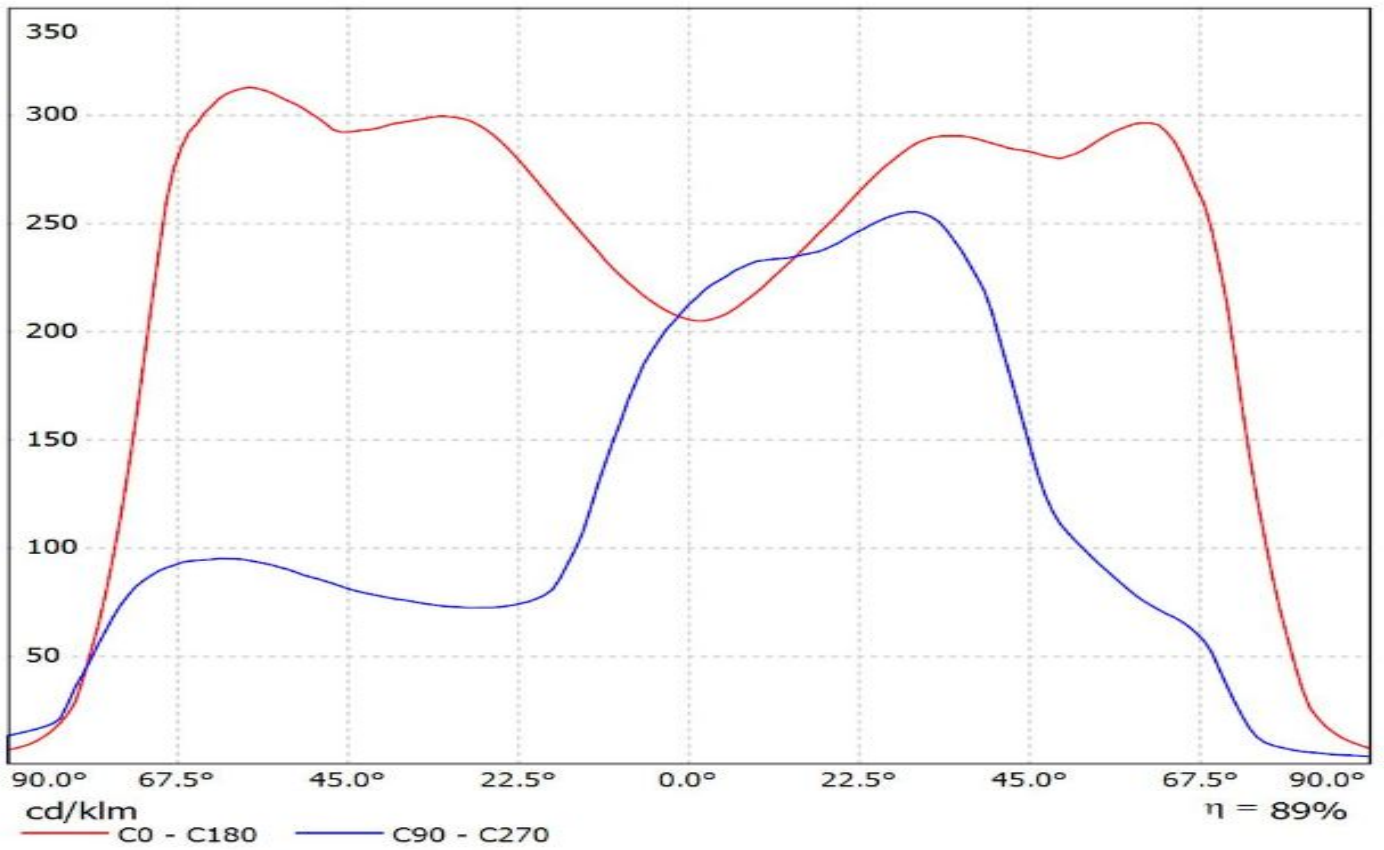

Luminaire: Ledil FN13323\_STELLA-A\_(Soleriq\_P9)

Lamps: 1 x Osram\_Soleriq\_P9\_(GW\_MAFJB1.EM)\_976.011lm@250mA\_CCT=4299K\_P=6.9W\_I=0.25A

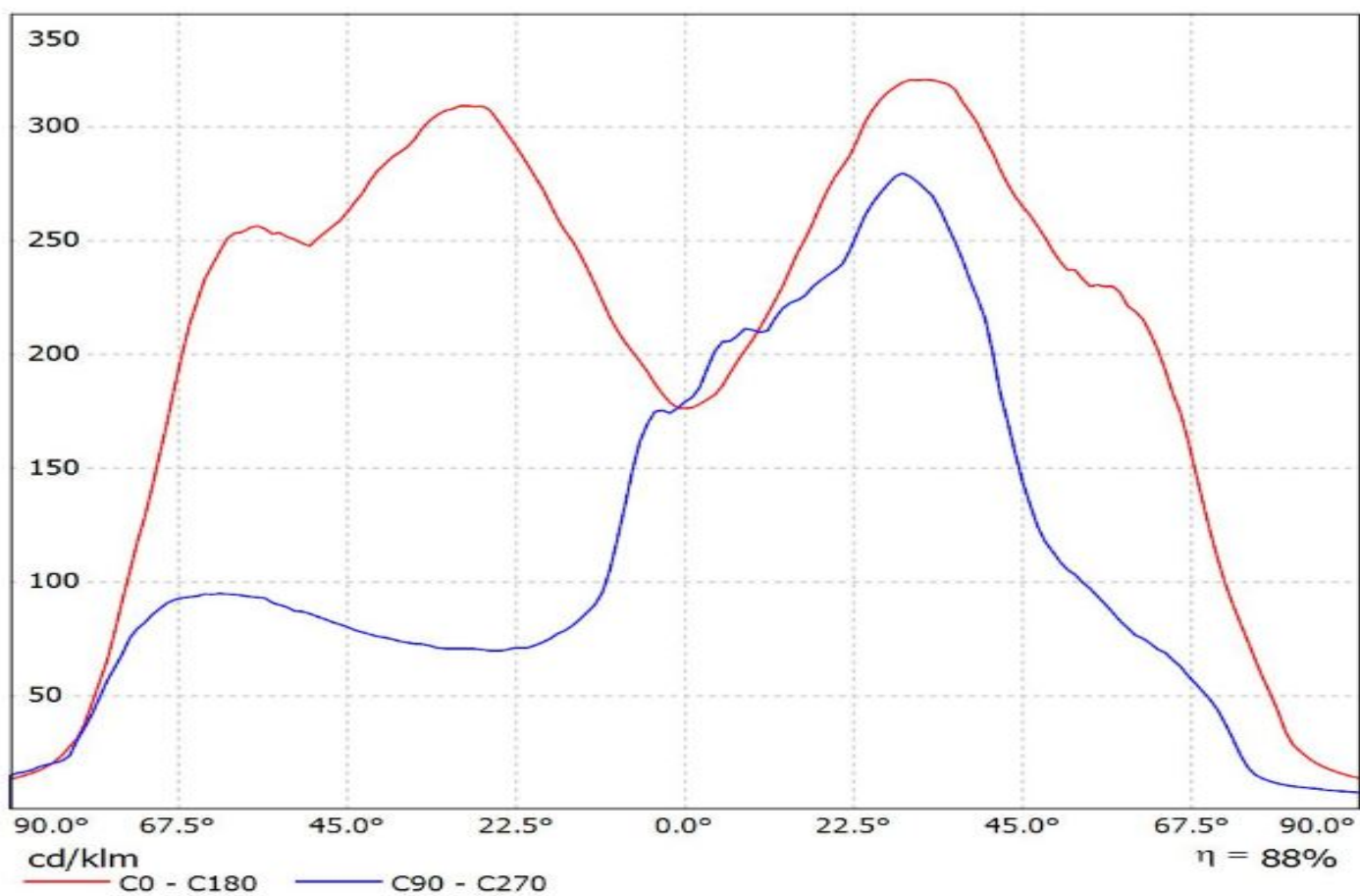

Luminaire: LEDiL Oy FN13323\_STELLA-A (Luxeon\_CoB\_1203)\_ (438\_Typ\_L1)

Lamps: 1 x Luxeon\_CoB\_1203\_(LHC1-3080-1203)\_ (438\_Typ\_L1)\_ 1005.18lm@250mA\_P=8.69829W\_I=0.2498A

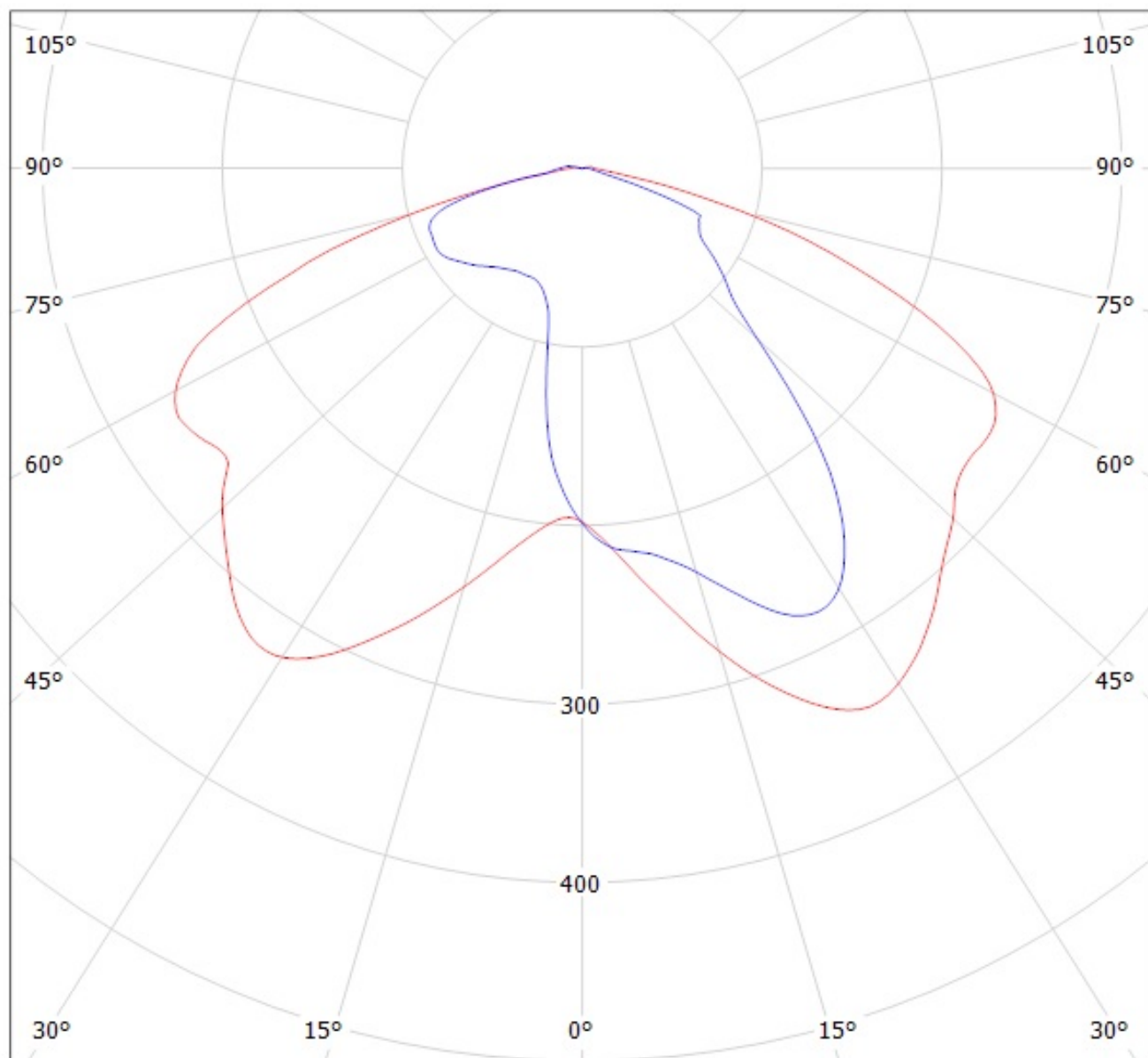

cd/klm

— C0 - C180

— C90 - C270

$\eta = 88\%$

# Ledil FN13323\_STELLA-A\_(NFCLL036B) / LDC (Polar)

Luminaire: Ledil FN13323\_STELLA-A\_(NFCLL036B)  
Lamps: 1 x Nichia\_NFCLL036B\_(SM403J1300R8000)  
\_563.488lm@100mA\_CCT=4000K\_P=3.35W\_I=0.100A

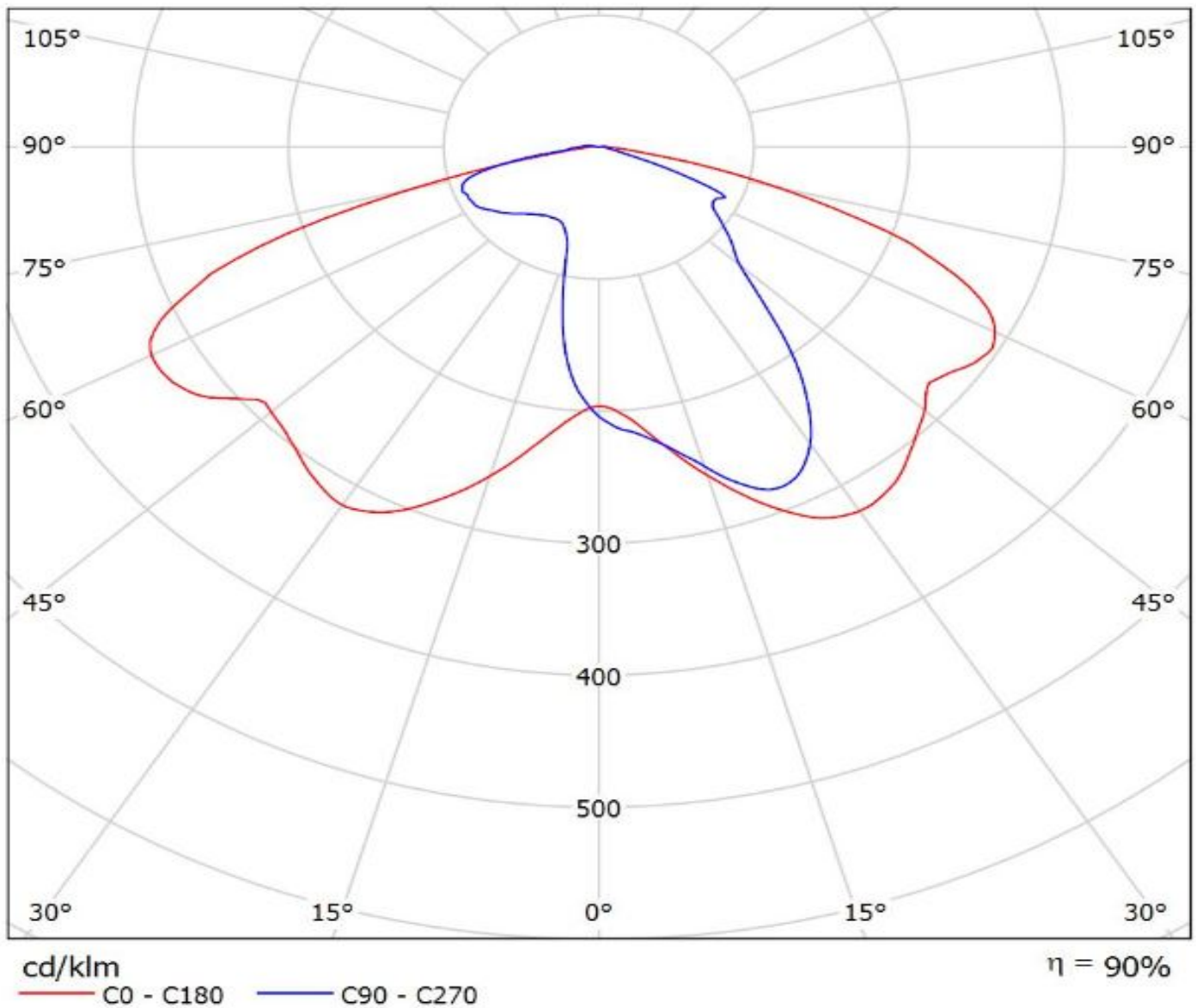

Luminaire: LEDiL Oy FN13323\_STELLA-A\_(CXM-18) Eff.89.2%  
Lamps: 1 x LUMINUS\_XNOVA\_CXM-18\_897.842lm@250mA\_P=8.12425W\_I=249.9mA

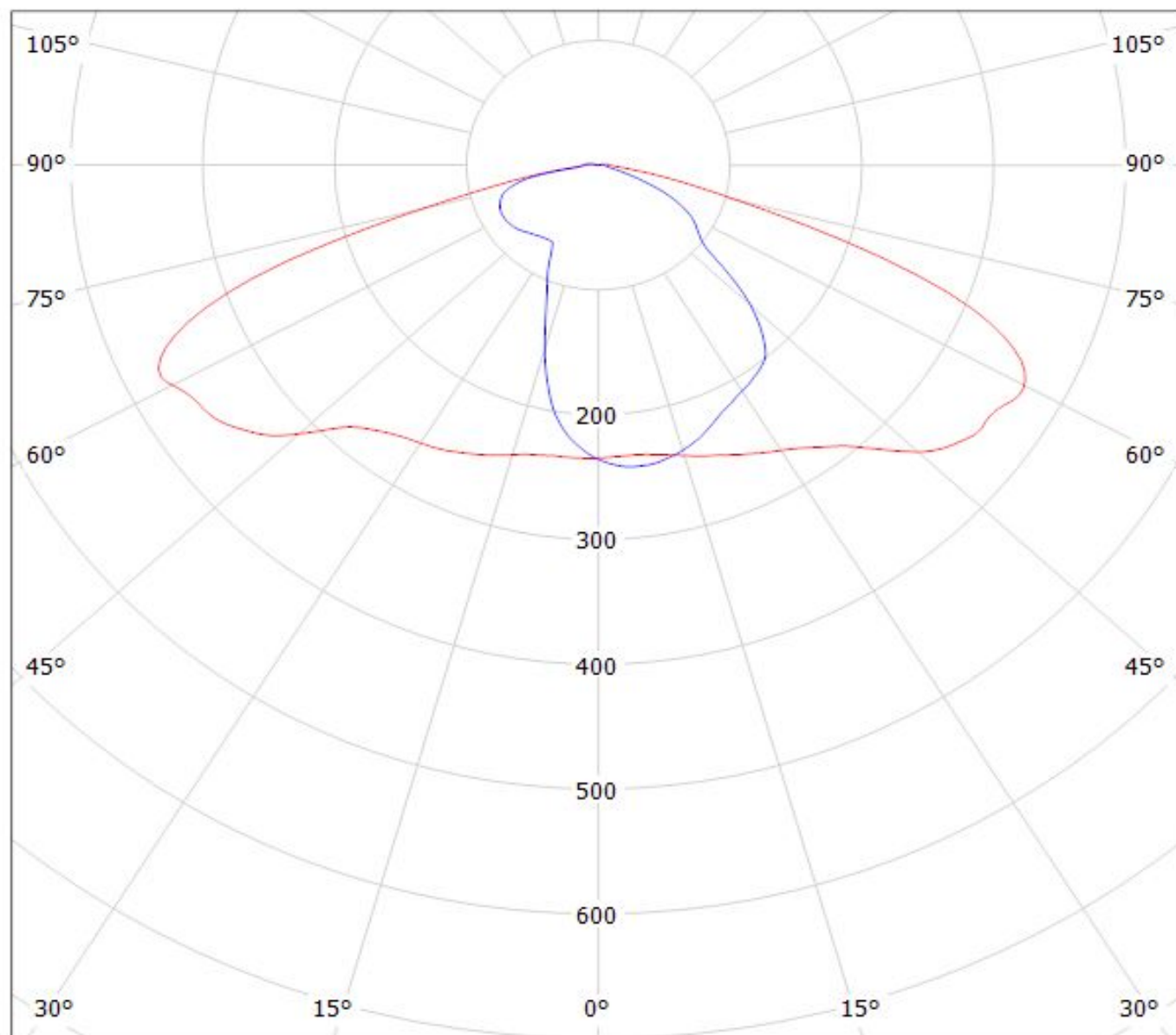

cd/klm

— C0 - C180 — C90 - C270

$\eta = 89\%$

Luminaire: LEDiL Oy FN13323\_STELLA-A\_(V15)

Lamps: 1 x Bridgelux\_V15\_1050.21lm@250mA\_P=8.19169W\_I=249.8mA

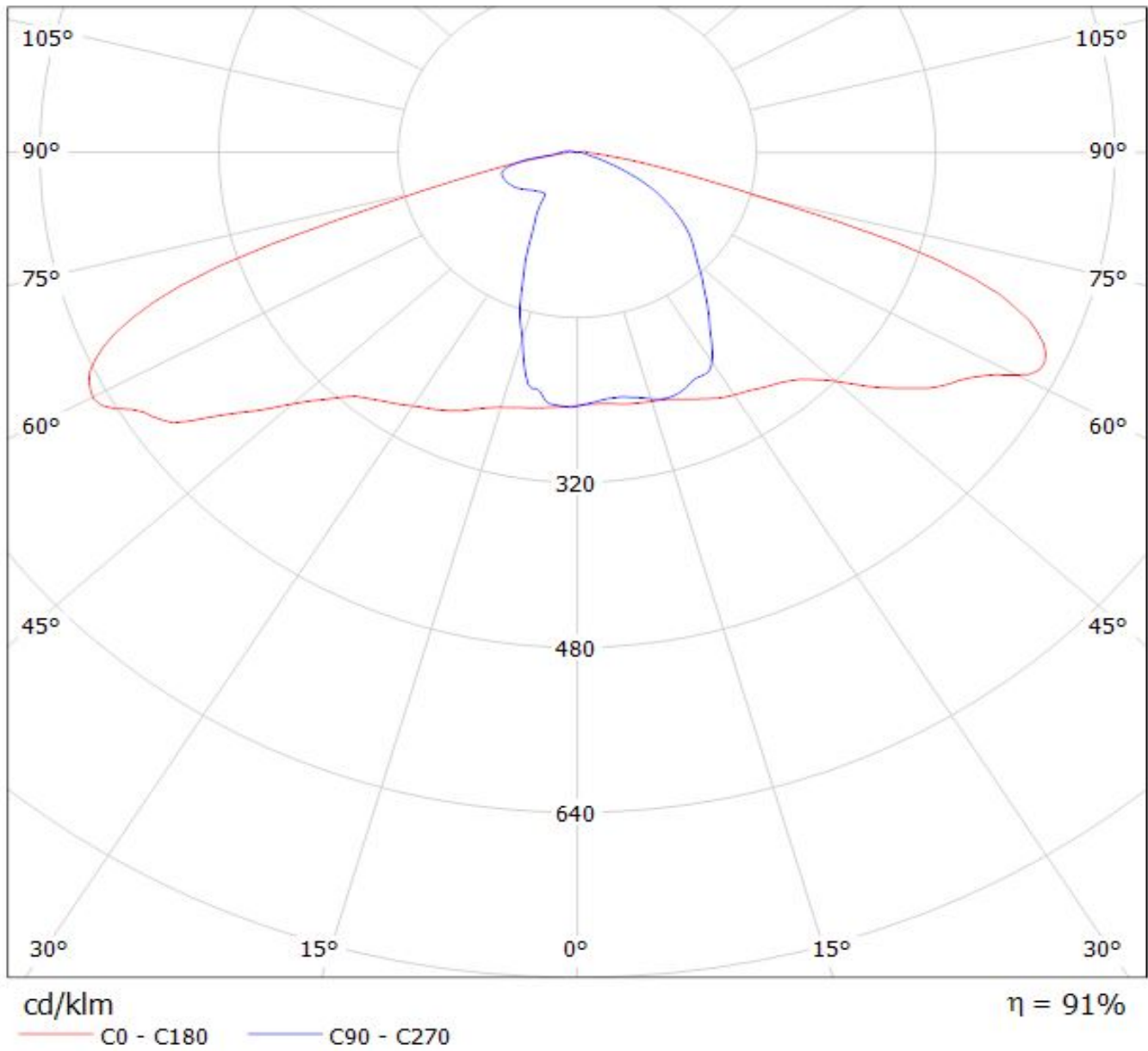

Luminaire: LEDiL Oy FN13323\_STELLA-A\_(SOLERIQ\_P13)

Lamps: 1 x SOLERIQ\_P13\_(GW\_MAGMB1.EM)\_929.576lm@250mA\_CCT=3500K\_P=8.72876W\_I=249.8mA

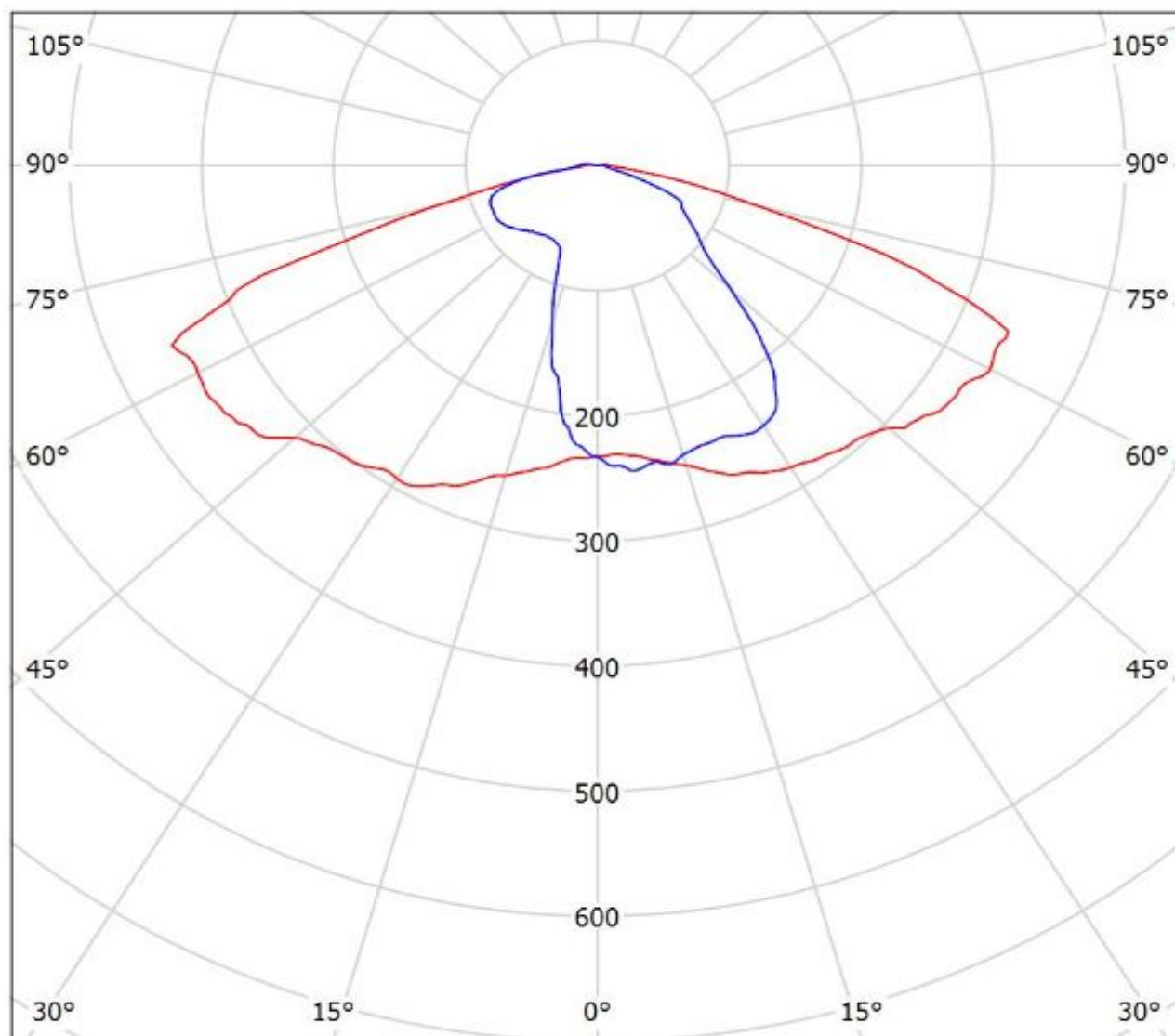

cd/klm

— C0 - C180 — C90 - C270

$\eta = 90\%$



Luminaire: Ledil FN13323\_STELLA-A\_(CXA1520)\_(441\_Typ\_L1) Citizen\_CXA1520\_(CXA1520-30F-N4-N0H-00001)\_(441\_Typ\_L1)\_1038.48lm@250mA\_P=8.8025W\_I=0.25A

Lamps: 1 x Citizen\_CXA1520\_(CXA1520-30F-N4-N0H-00001)\_(441\_Typ\_L1)  
\_1038.48lm@250mA\_P=8.8025W\_I=0.25A

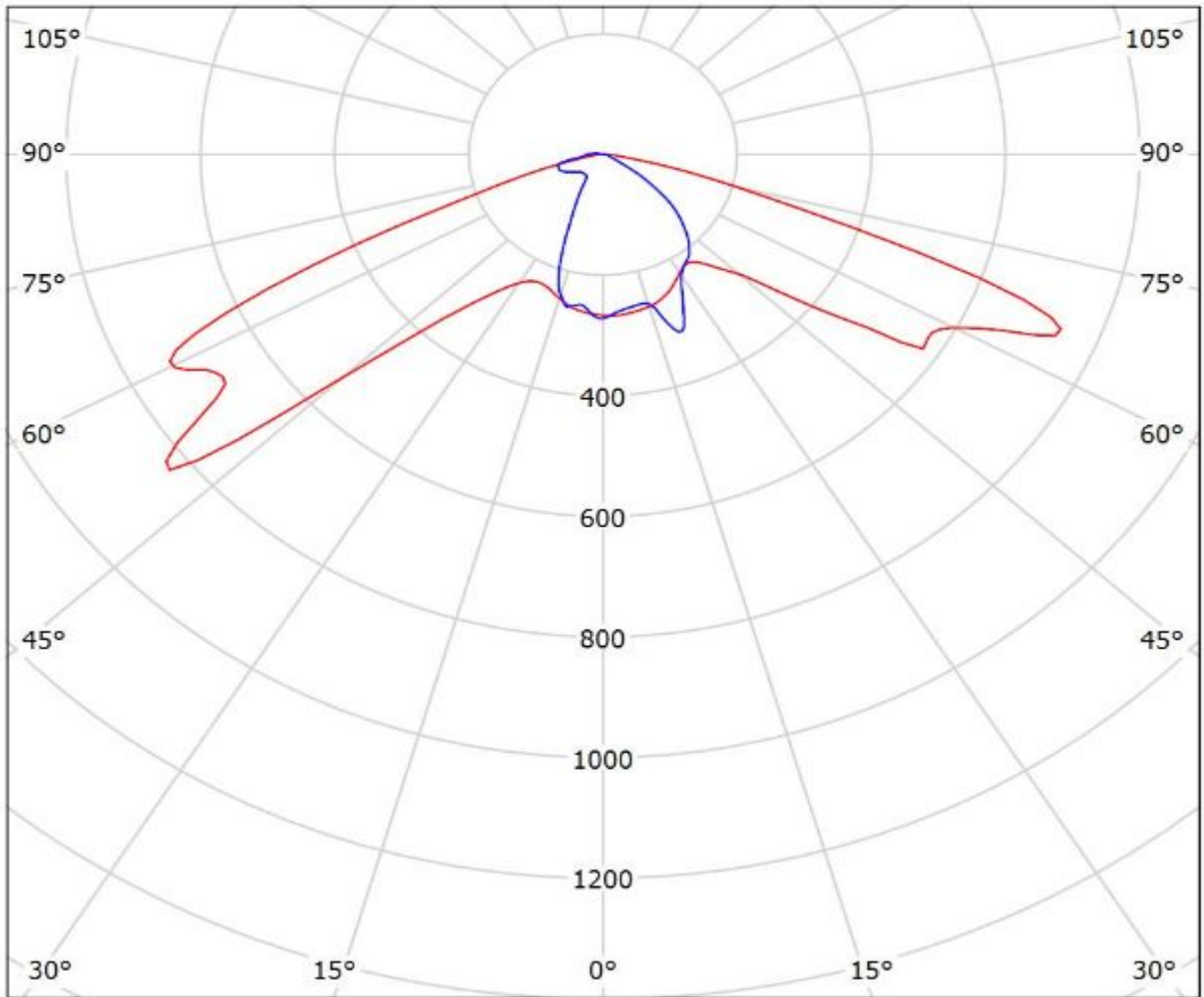

cd/klm

— C0 - C180    — C90 - C270

$\eta = 92\%$

Luminaire: LEDiL Oy FN13323\_STELLA-A\_(CXA25) Eff. 93%

Lamps: 1 x CREE\_CXA25 (CXA2530-7C0-T2-N0H)1100lm@250mA CCT=3000K P=8W I=250mA

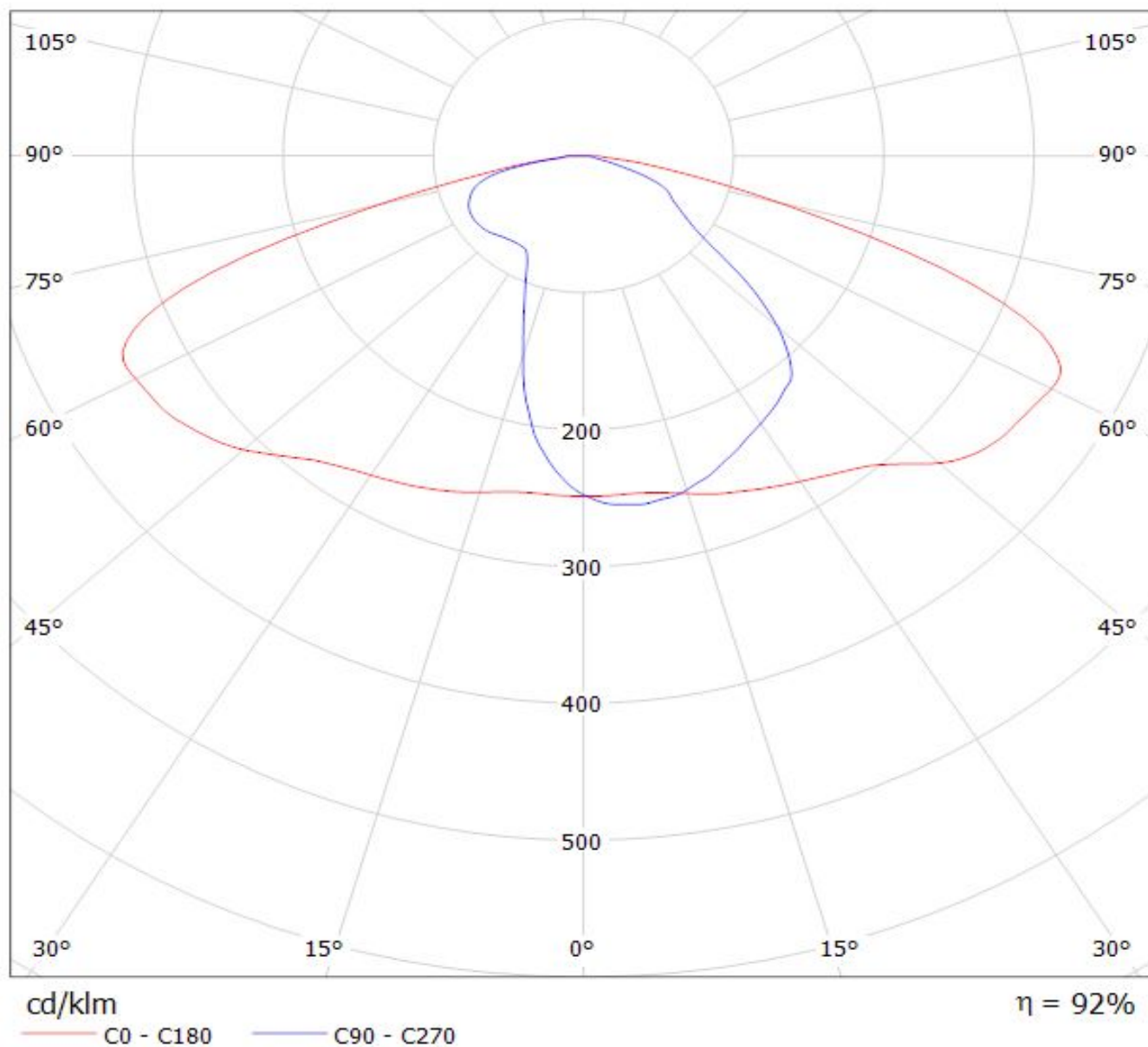

Luminaire: LEDiL Oy FN13323\_STELLA-A\_(CXA1507) Eff: 92%

Lamps: 1 x Cree\_CXA1507\_(CXA1507-30F-F2-N0A-0000) 220lm@50mA CCT=3000K P=2W I=50mA

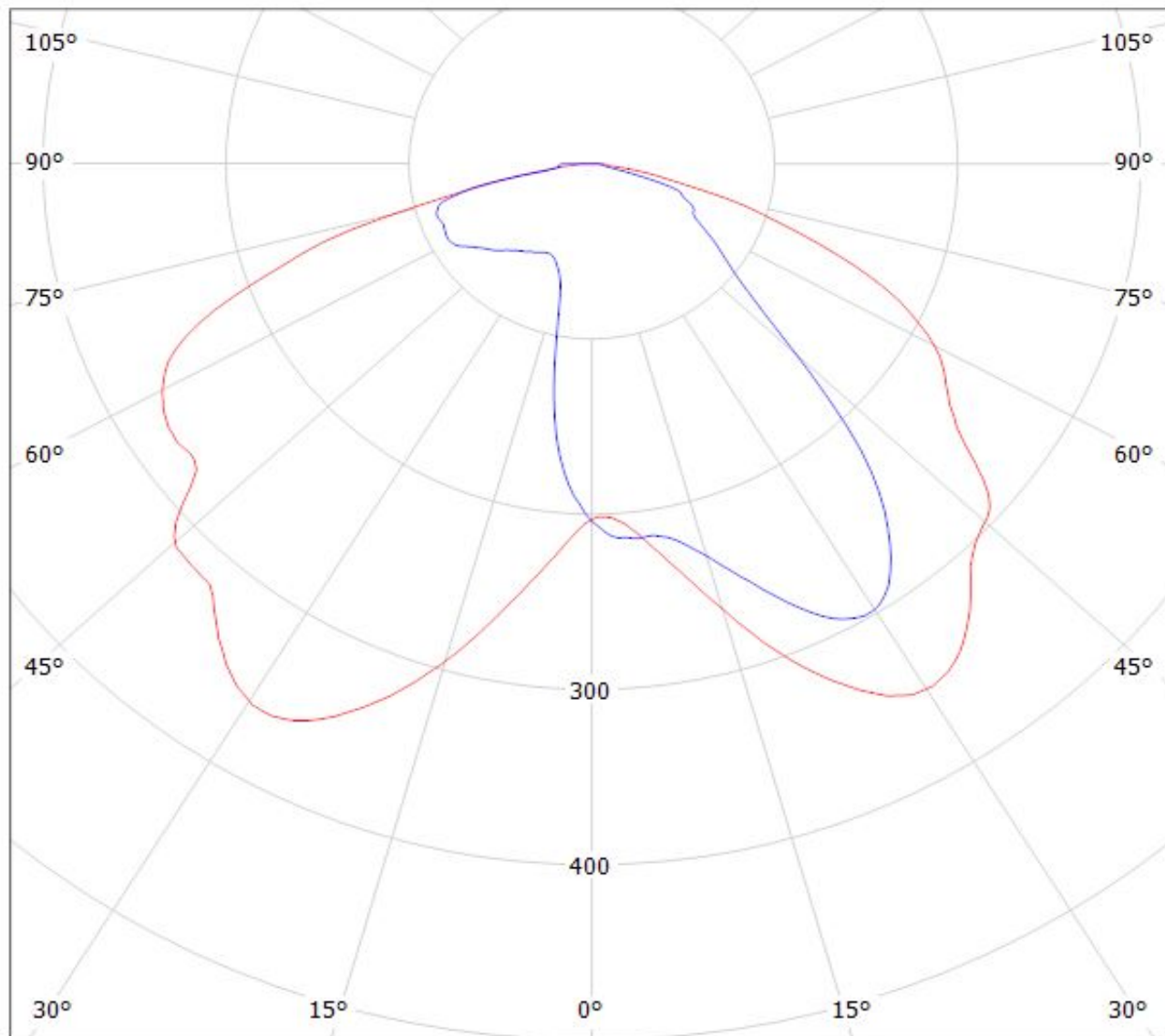

cd/klm

— C0 - C180

— C90 - C270

$\eta = 91\%$

Luminaire: LEDiL Oy FN13323\_STELLA-A\_(Soleriq\_S13)

Lamps: 1 x Osram\_Soleriq\_S13\_802.964lm@250mA\_CCT=3125K\_P=7.26069W\_I=249.8mA

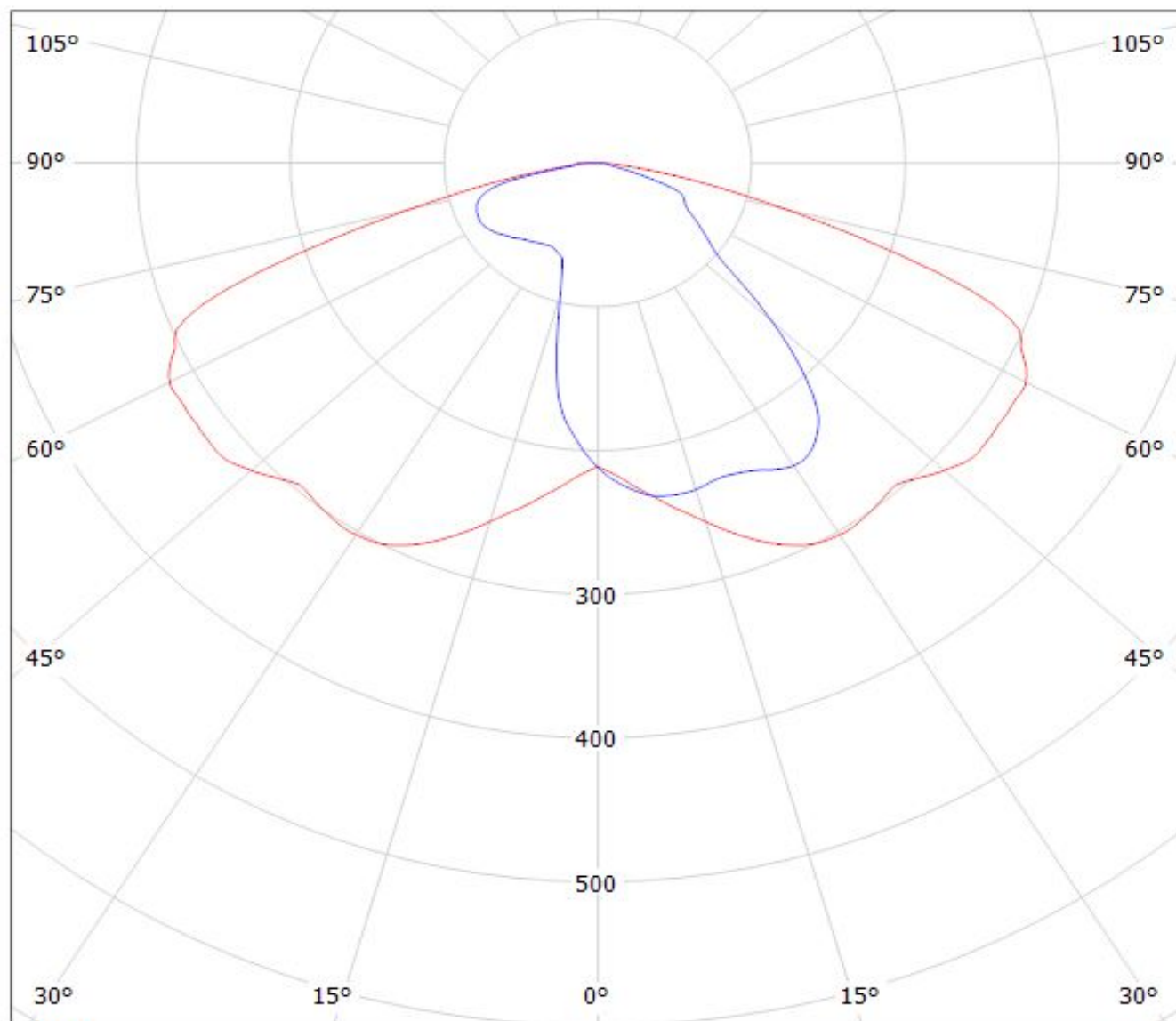

cd/klm

$\eta = 91\%$

— C0 - C180    — C90 - C270

Luminaire: Ledil FN13323\_STELLA-A\_(CLU710)

Lamps: 1 x CITIZEN\_CLU710\_(CLU710-1204B8-273M2G1)\_1212.66lm@250mA\_P=8.5W\_I=0.25A

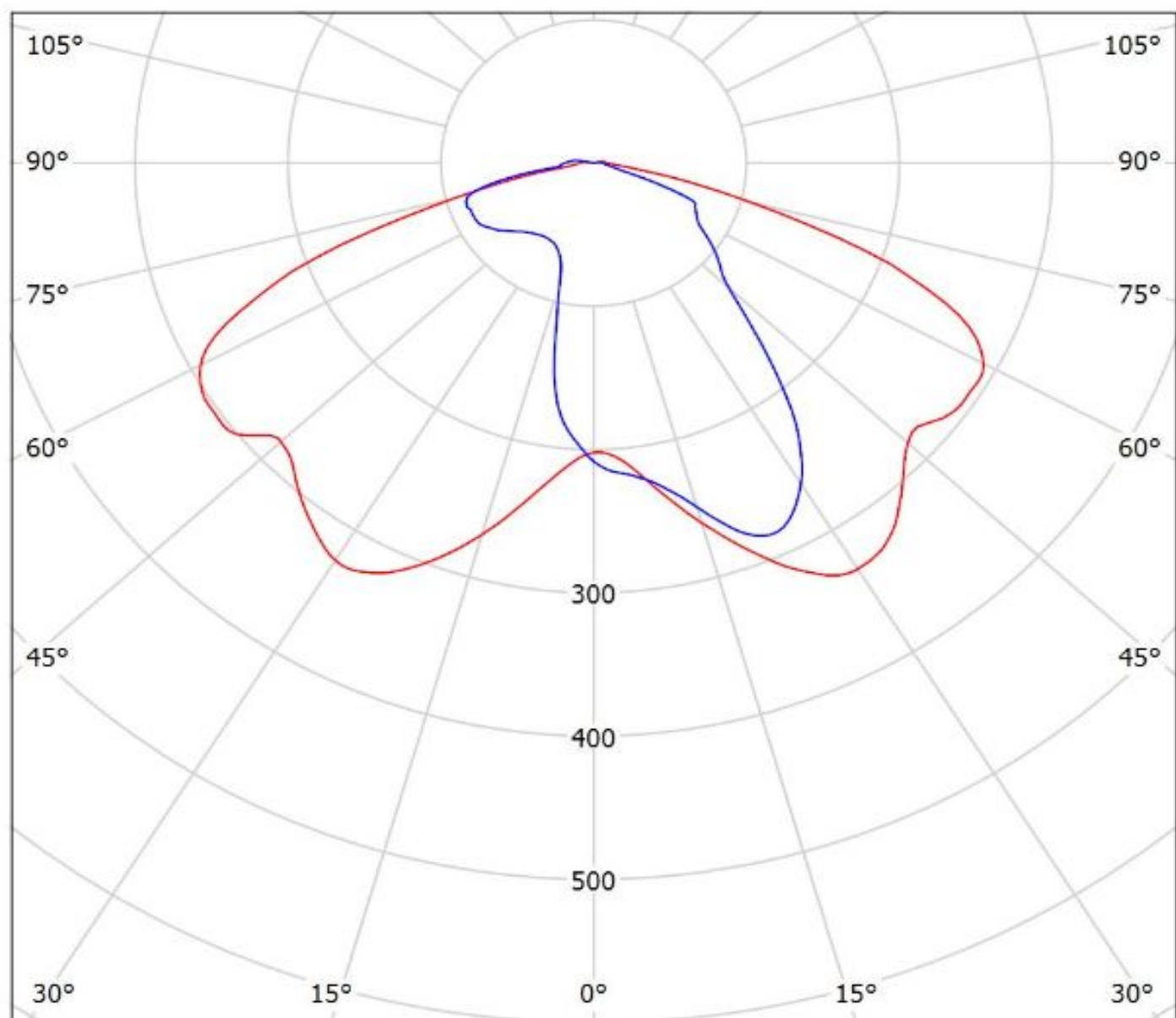

cd/klm

— C0 - C180

— C90 - C270

$\eta = 89\%$

# Ledil FN13323\_STELLA-A\_(CLU720) / LDC (Polar)

Luminaire: Ledil FN13323\_STELLA-A\_(CLU720)  
Lamps: 1 x CITIZEN\_CLU720\_(CLU720-1206B8-273M2)  
\_1298.17lm@250mA\_CCT=2700K\_P=8.3W\_I=0.25A

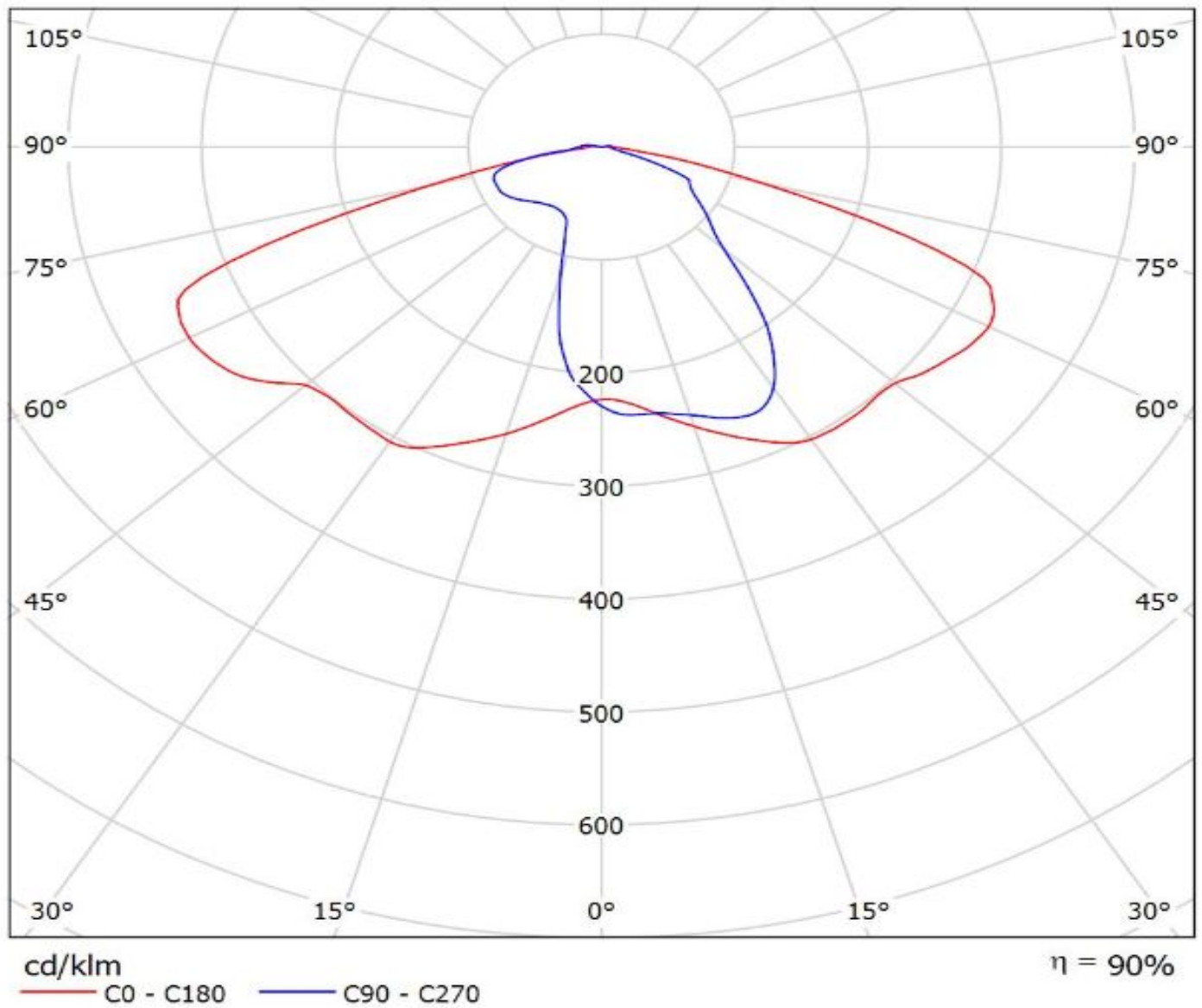

Luminaire: Ledil FN13323\_STELLA-A\_(CLU700)\_(434\_Typ\_L1)

Lamps: 1 x Citizen\_CLU700\_(CLU700-1002B8-273M2G1)\_(434\_Typ\_L1)\_390.128lm@100mA\_P=3W\_I=0.10A

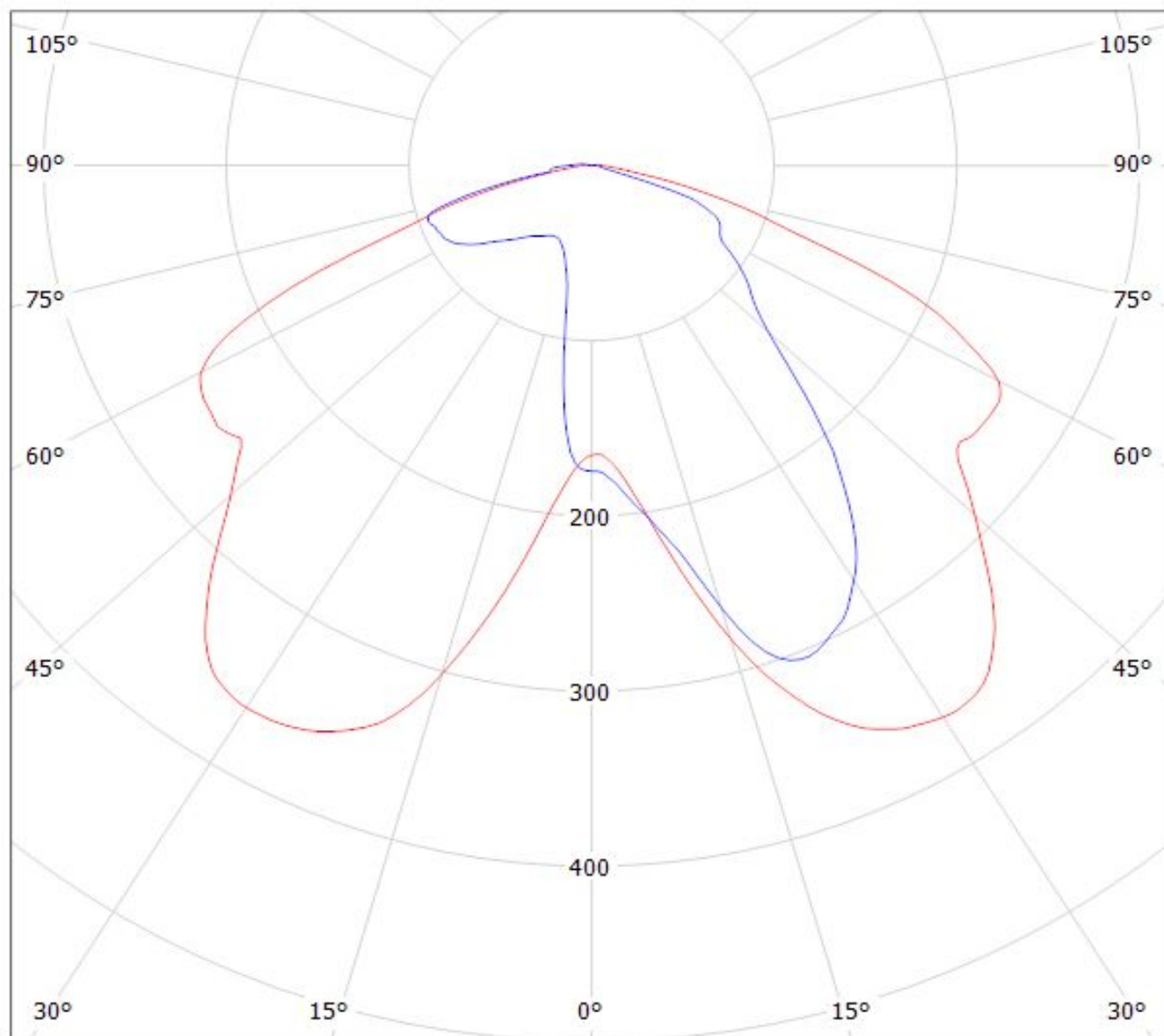

cd/klm

— C0 - C180

— C90 - C270

$\eta = 89\%$

Luminaire: Ledil FN13323\_STELLA-A\_(CLU720)\_(433\_Typ\_L1)

Lamps: 1 x Citizen\_CLU720\_(CLU720-1206B8-273M2G1)\_1204.28lm@250mA\_P=8.25W\_I=0.25A

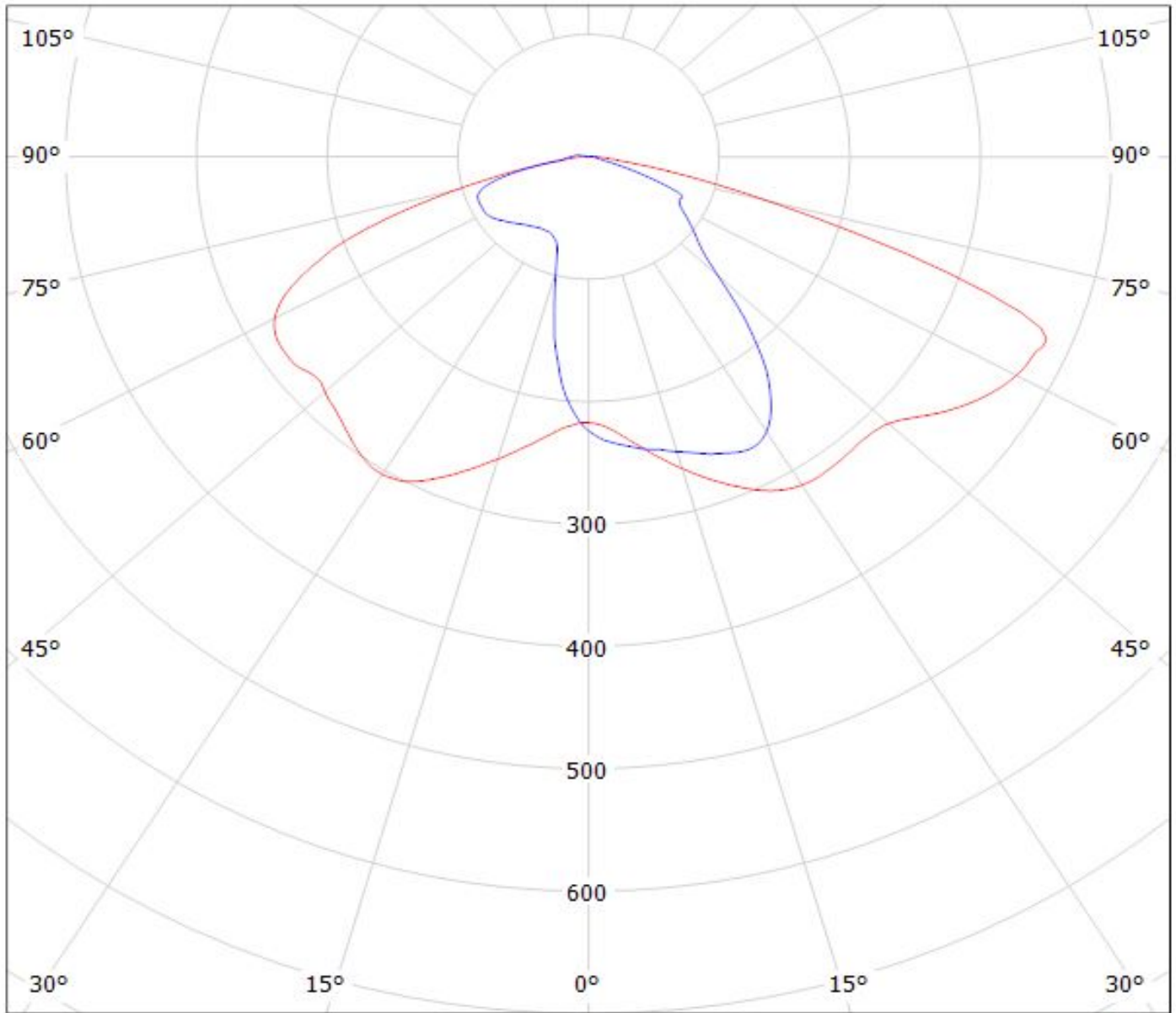

cd/klm

— C0 - C180

— C90 - C270

$\eta = 91\%$



Luminaire: LEDiL Oy FN13323\_STELLA-A Eff. 92%

Lamps: 1 x VERO13 (BXRC-30E4000F) 819lm@250mA CCT=3000K P=7.5W I=250mA

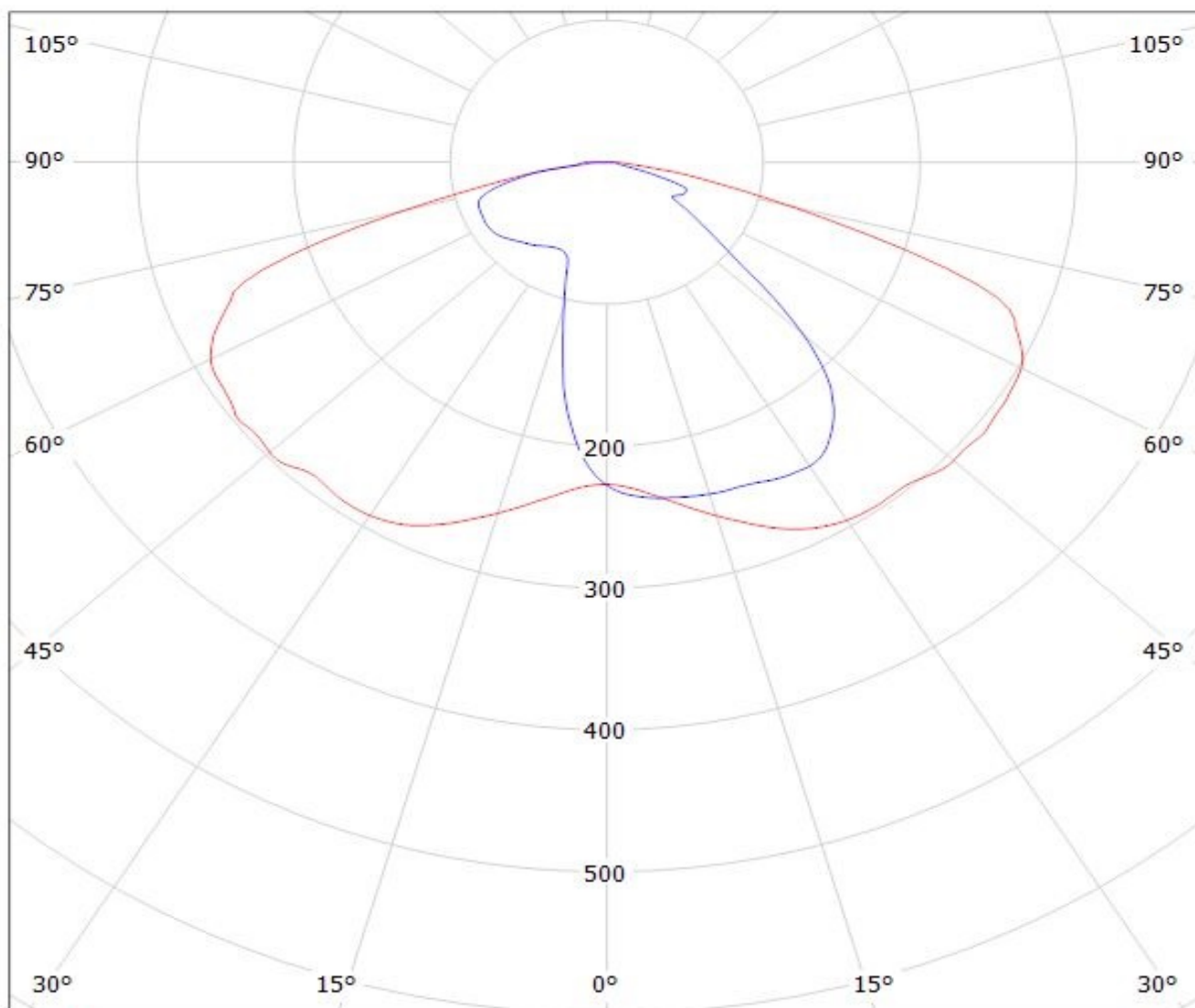

cd/klm

— C0 - C180

— C90 - C270

Luminaire: LEDiL Oy FN13323\_STELLA-A (VERO18) Eff. 92%

Lamps: 1 x VERO18 (BXRC-30E4000F)786lm@250mA CCT=3000K P=6.84W I=250mA

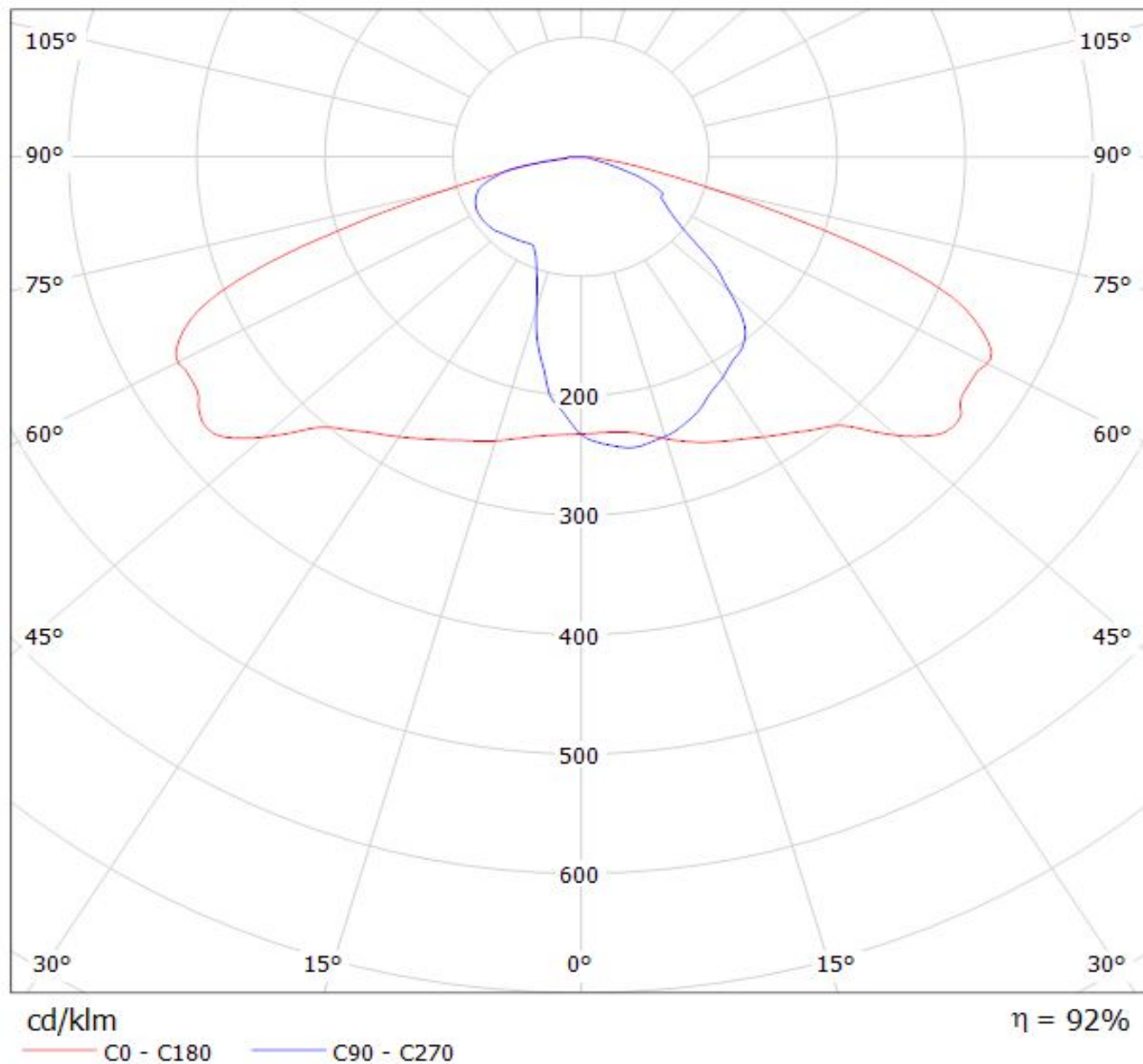

# Ledil FN13323\_STELLA-A\_(P13) / LDC (Polar)

Luminaire: Ledil FN13323\_STELLA-A\_(P13)  
Lamps: 1 x Osram Soleriq P13 (GW MAGMB1.EM)  
\_929.576lm@250mA\_CCT=3500K\_P=8.72876W\_I=249.8mA

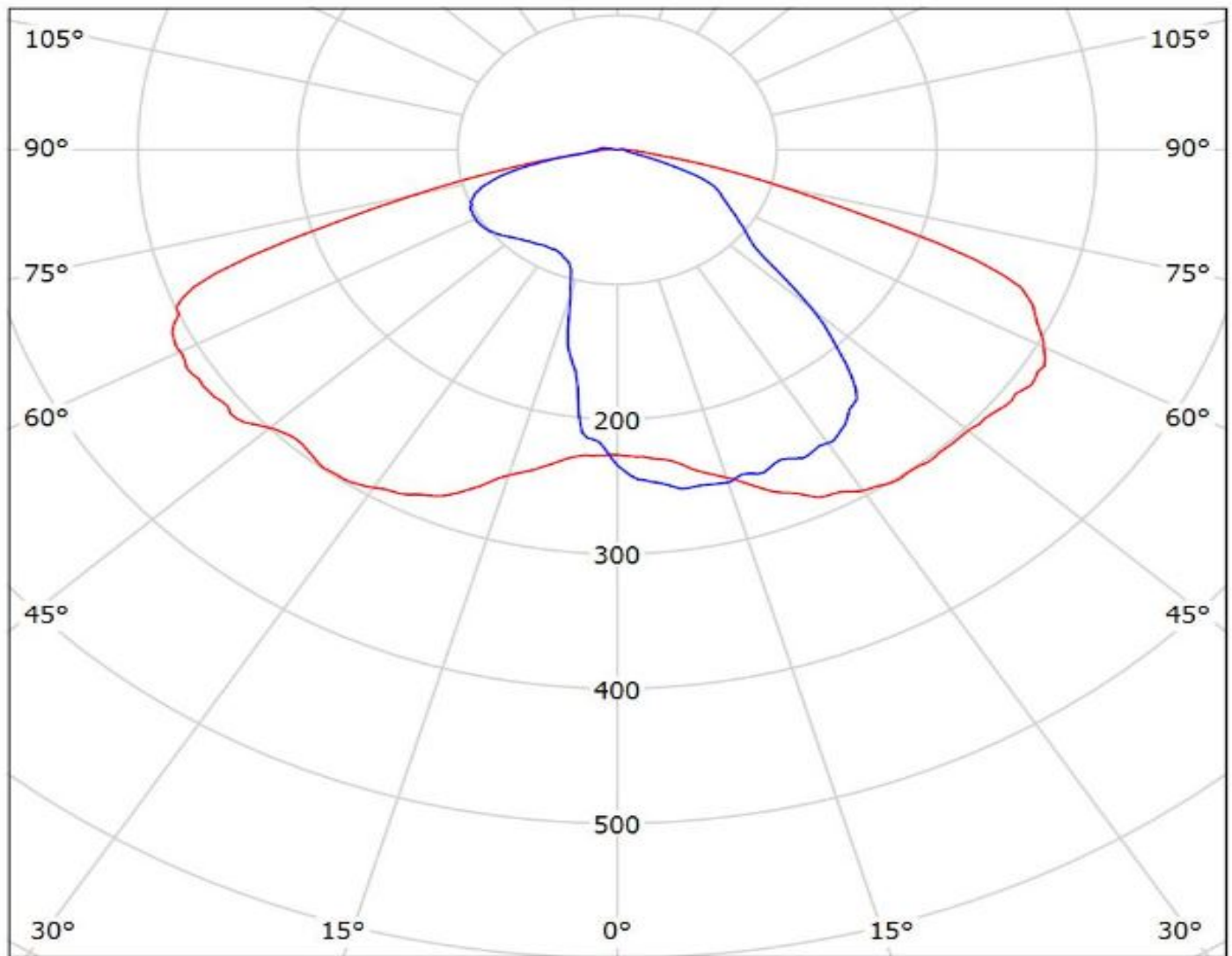

cd/klm  
— C0 - C180 — C90 - C270

$\eta = 94\%$

# Ledil FN13323\_STELLA-A\_(Soleriq\_S13) / LDC (Polar)

Luminaire: Ledil FN13323\_STELLA-A\_(Soleriq\_S13)

Lamps: 1 x Osram\_Soleriq\_S13\_(GW\_KAGHB1.EM)\_875.214lm@250mA\_P=7.44679W\_I=250mA

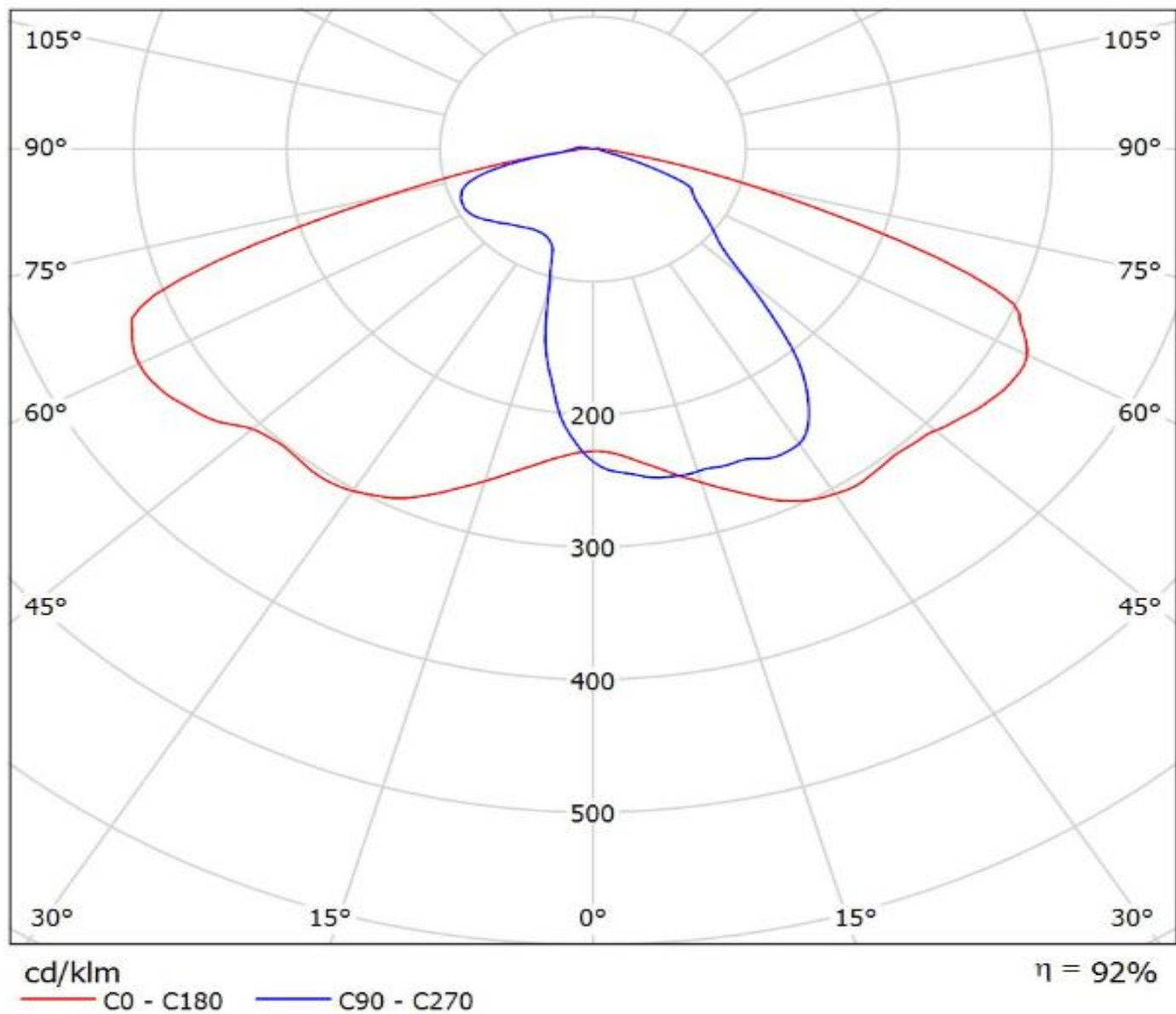

Luminaire: LEDiL Oy FN13323\_STELLA-A\_(CXM-14)  
Lamps: 1 x LUMINUS\_XNOVA\_CXM-14\_(AC00)  
\_1064.17lm@250mA\_CCT=3133K\_P=8.33558W\_I=249.8mA

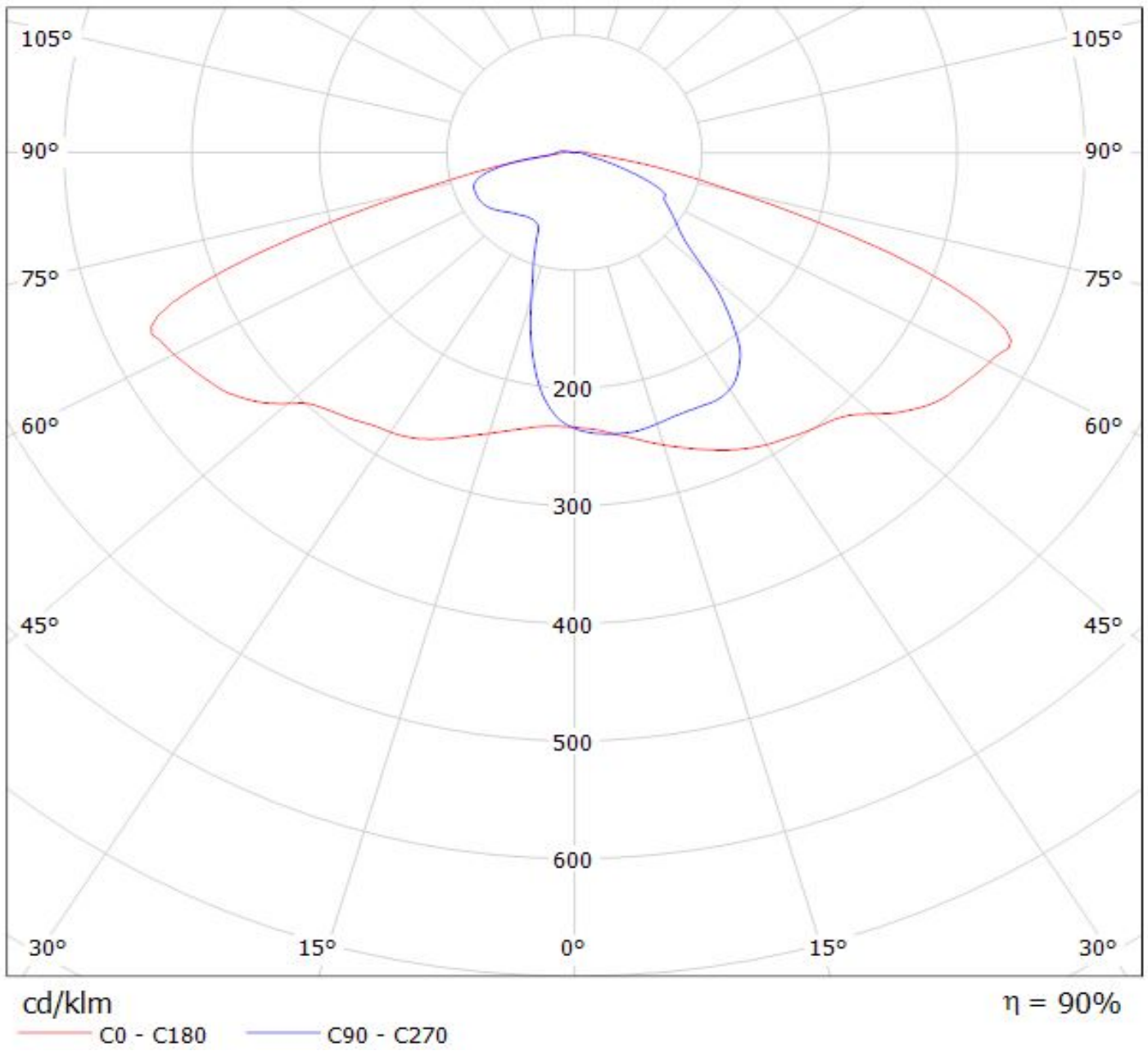

Luminaire: LEDiL Oy FN13323\_STELLA-A\_(CLL030) Eff. 92%

Lamps: 1 x Citizen\_CLL030\_(CLL030-1205A5-303H1A7) 690lm@250mA CCT=3000K P=9W I=250mA

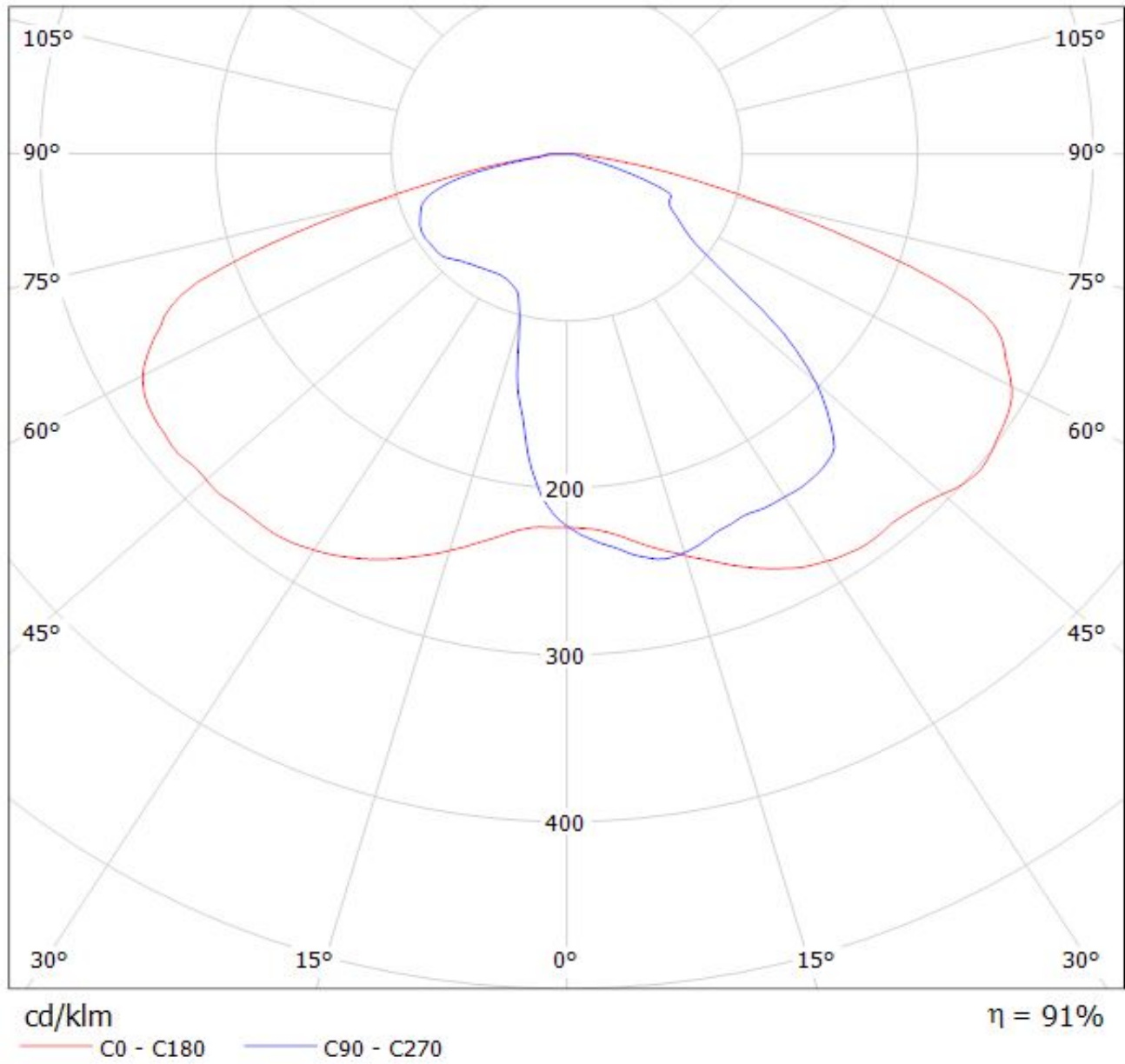

# Ledil FN13323\_STELLA-A\_(CXA1850) / LDC (Polar)

Luminaire: Ledil FN13323\_STELLA-A\_(CXA1850)

Lamps: 1 x CREE\_CXA1850\_(CXA1850-30F-T4-N0Y-00001)

\_837.004lm@250mA\_CCT=3000K\_P=8.24W\_I=0.25A

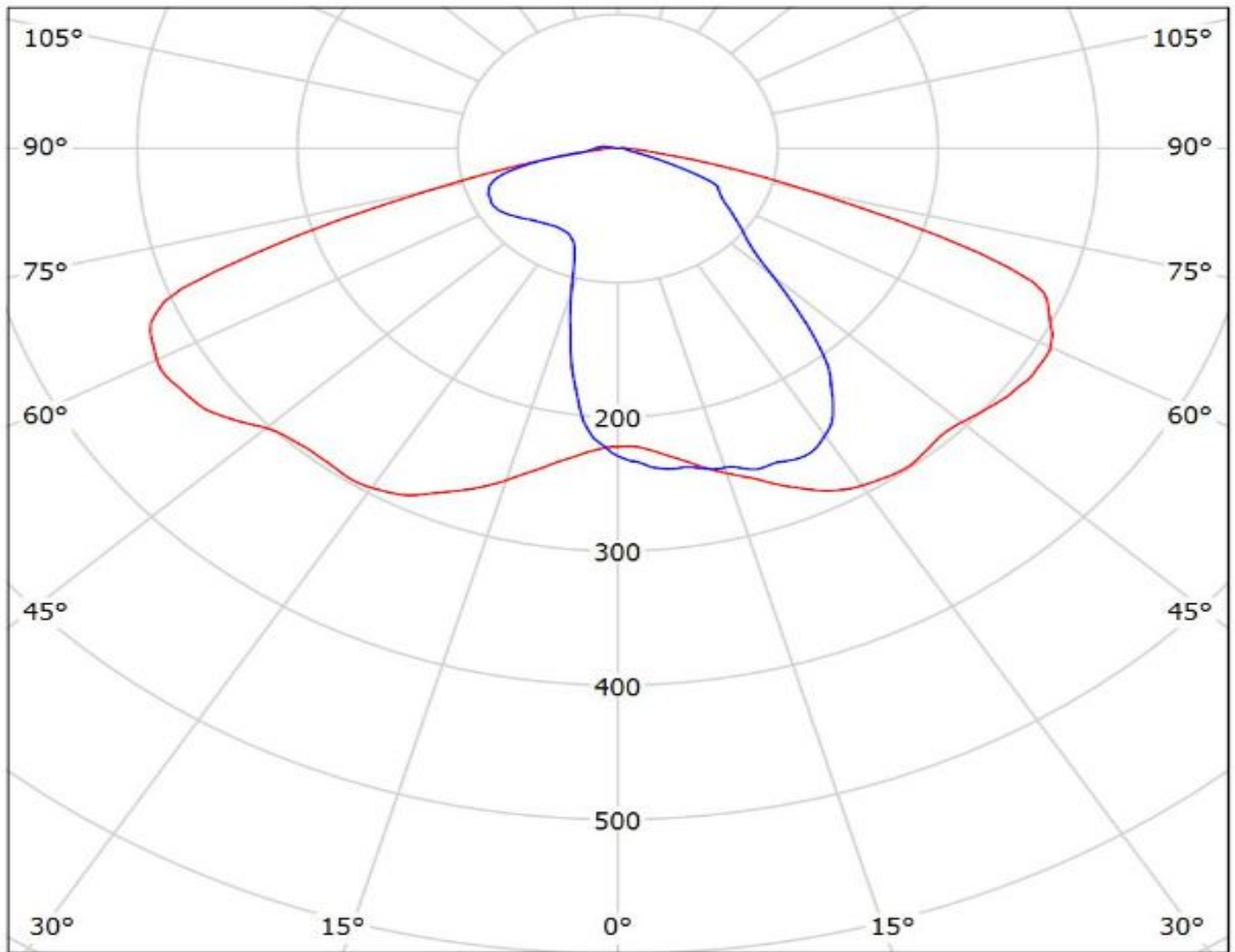

cd/klm

— C0 - C180    — C90 - C270

$\eta = 89\%$

# LEDiL Oy FN13323\_STELLA-A\_(CXA1816) Eff.87.1% / LDC (Polar)

Luminaire: LEDiL Oy FN13323\_STELLA-A\_(CXA1816) Eff.87.1%

Lamps: 1 x CREE\_CXA1816\_1075.33lm@250mA\_P=8.66981W\_I=249.8mA

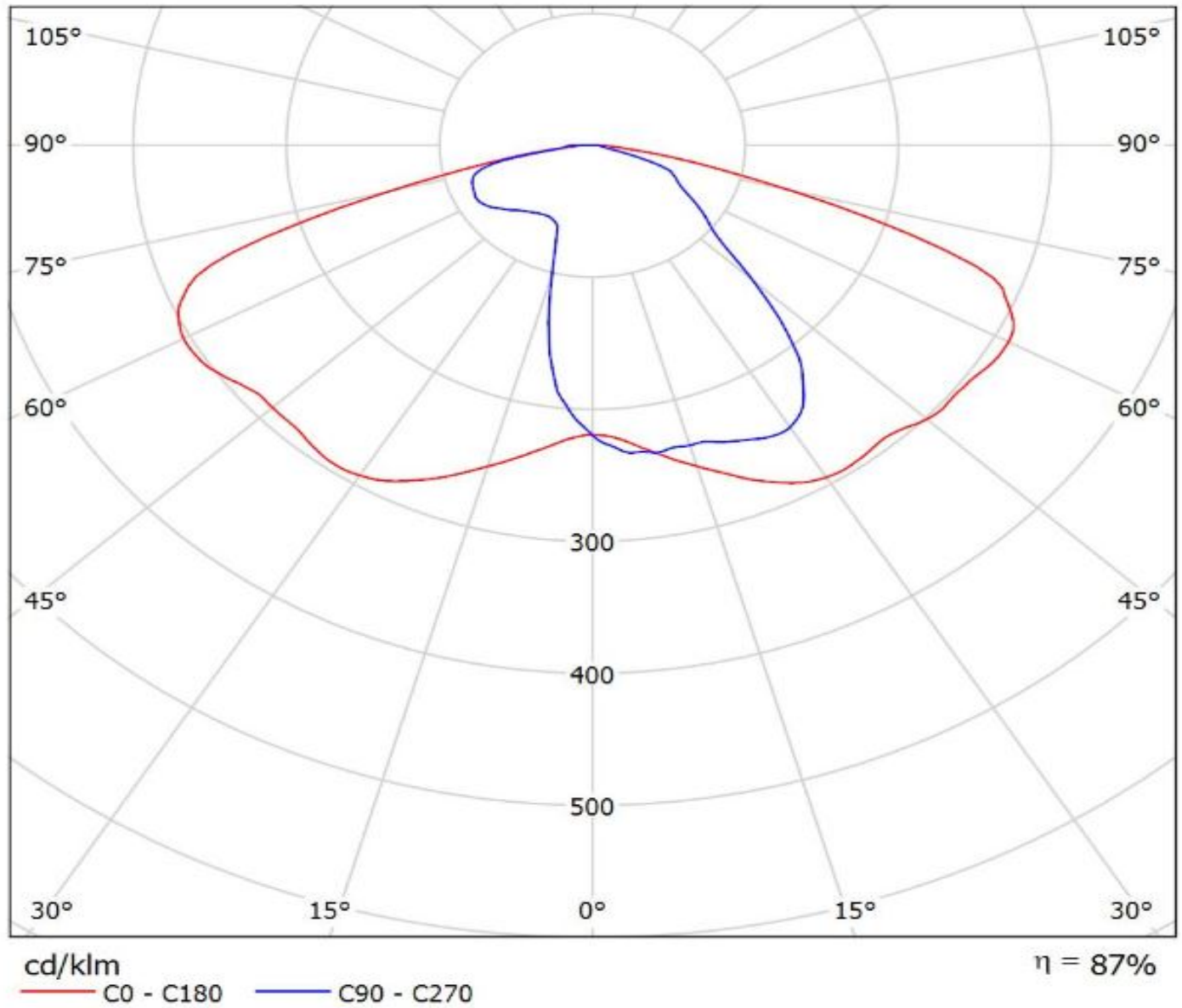



Luminaire: LEDiL Oy FN13323\_STELLA-A\_(SOLERIQ\_S19)

Lamps: 1 x OSRAM\_SOLERIQ\_S19\_(GW\_KAHJB1.EM)\_1340.3lm@250mA\_CCT=3000K\_P=10.4491W\_I=249.8mA

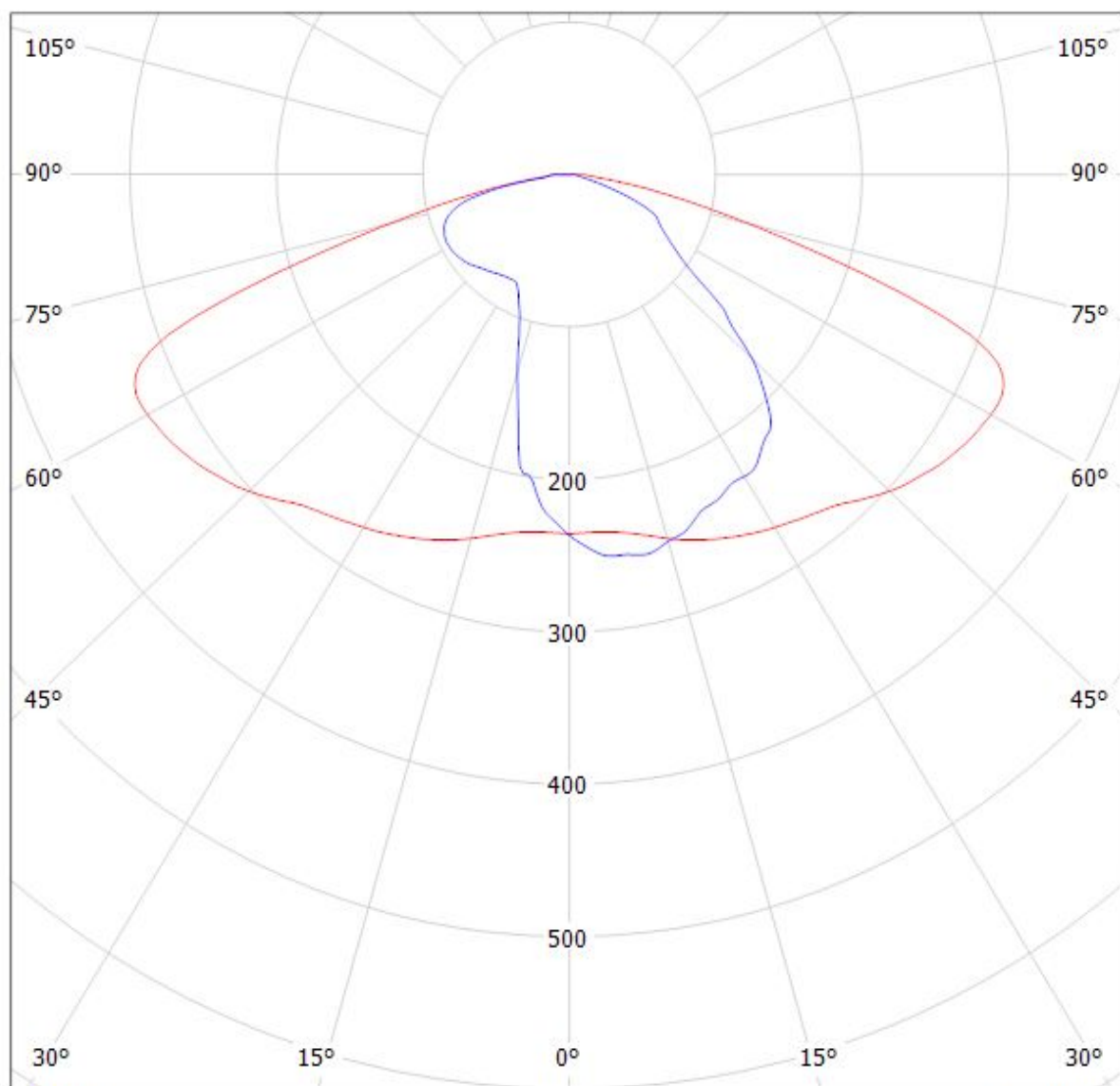

cd/klm

η = 90%

— C0 - C180

— C90 - C270

Luminaire: LEDiL Oy FN13323\_STELLA-A\_(Megazenigata\_GW6D) Eff.89.9%

Lamps: 1 x SHARP\_Megazenigata\_(GW6DMC40NFC)\_1072.13lm@250mA\_P=8.51443W\_I=249.8mA

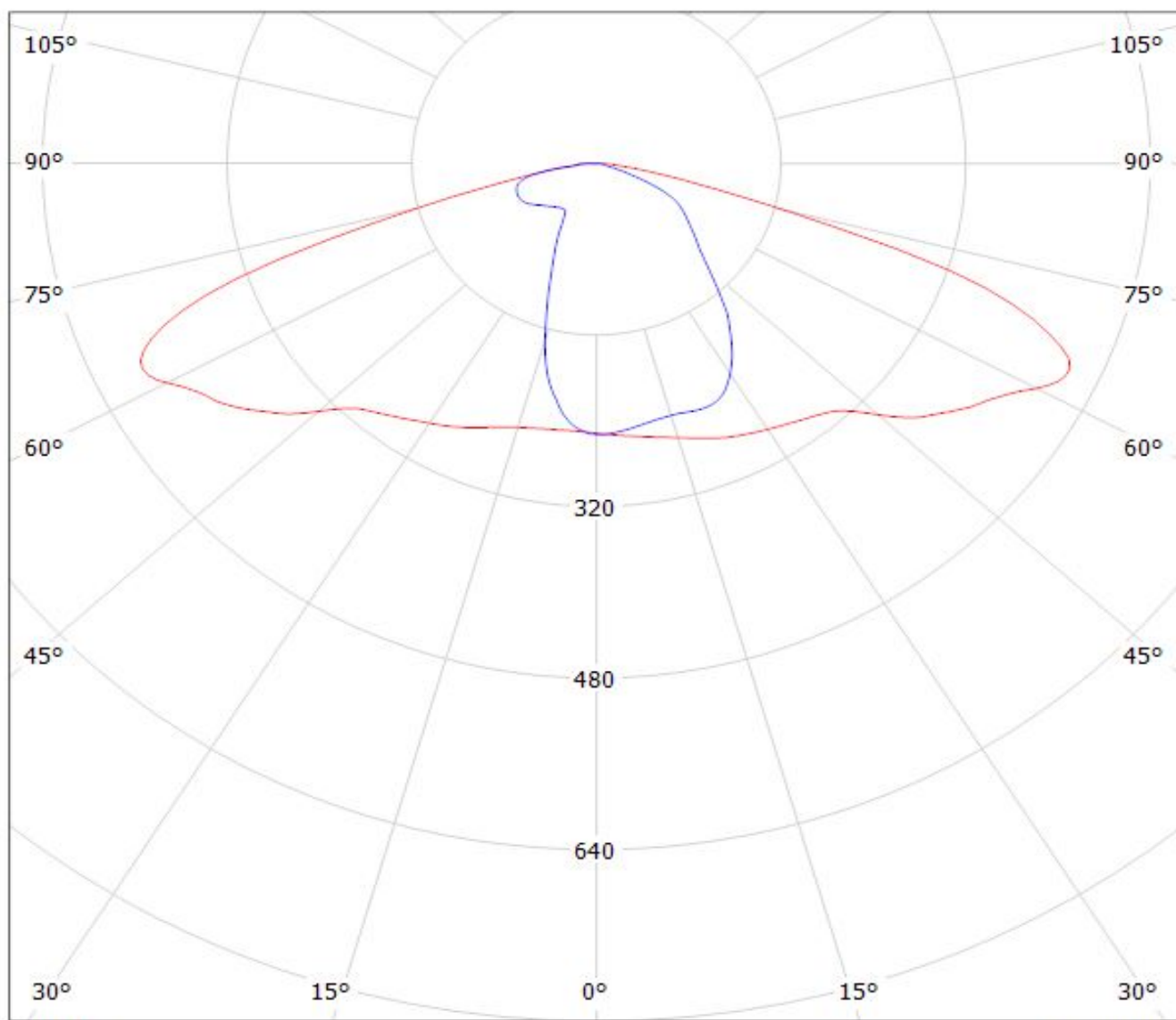

cd/klm

$\eta = 90\%$

— C0 - C180 — C90 - C270

# Ledil FN13323\_STELLA-A\_(NFCLL060B) / LDC (Polar)

Luminaire: Ledil FN13323\_STELLA-A\_(NFCLL060B)

Lamps: 1 x Nichia\_NFCLL060B\_(sm406G2450R8000)\_1368.94lm@250mA\_P=8.5W\_I=0.25A

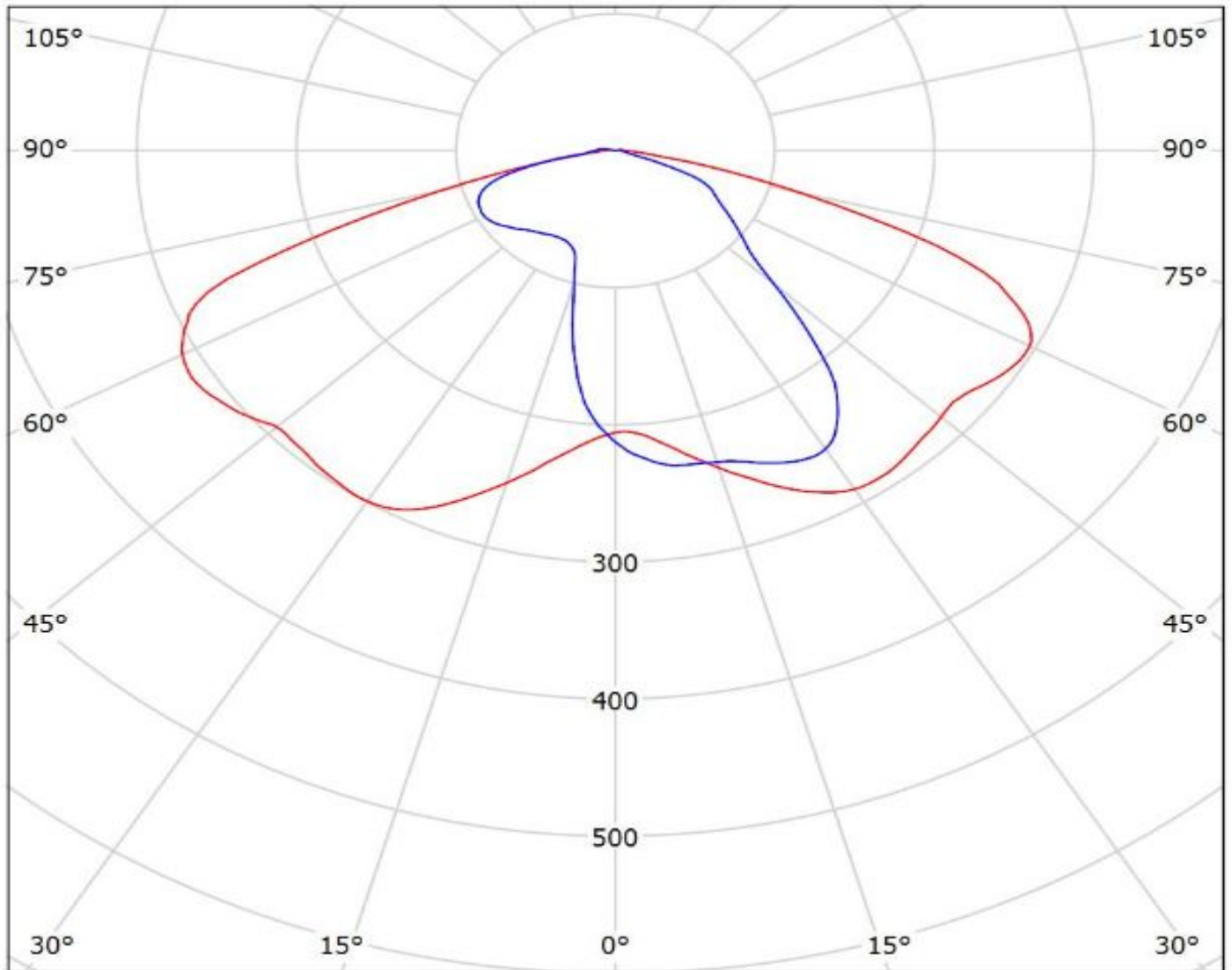

cd/klm

— C0 - C180    — C90 - C270

$\eta = 89\%$

Luminaire: Ledil FN13323\_STELLA-A\_(Soleriq\_P9)

Lamps: 1 x Osram\_Soleriq\_P9\_(GW\_MAFJB1.EM)\_976.011lm@250mA\_CCT=4299K\_P=6.9W\_I=0.25A

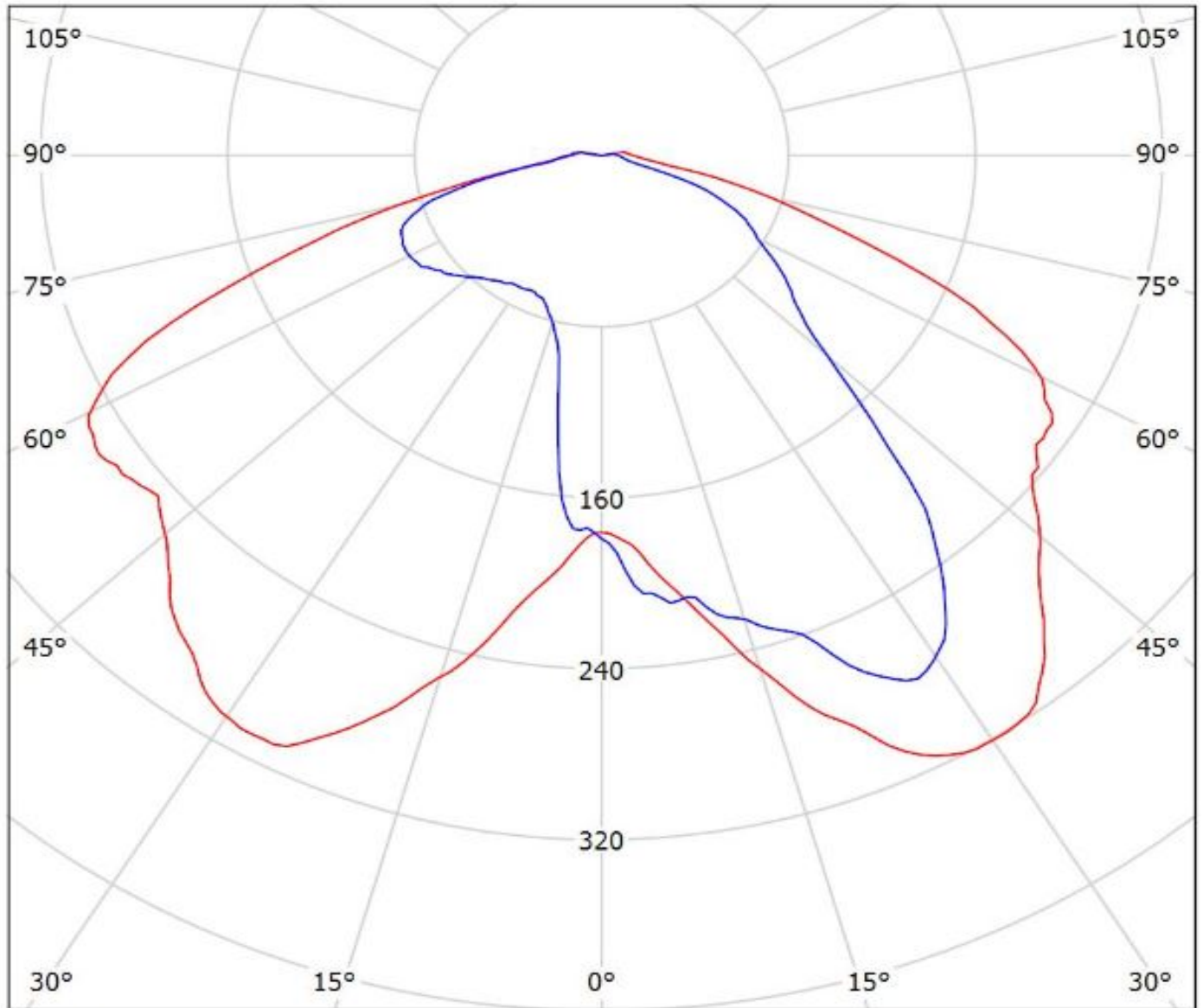

cd/klm  
— C0 - C180 — C90 - C270

$\eta = 88\%$

**NOTE: The typical divergence will be changed by different color, chip size and chip position tolerance. The typical total divergence is the full angle measured where the luminous intensity is half of the peak value.**

### **GENERAL INFORMATION**

- Product series especially designed & optimized for series of LEDs.
- Special care taken to make light distribution as uniform as possible.

Note! Due to use of high power COB's with this product, special attention to proper thermal design is highly recommended. LEDiL has no liability for direct, indirect or consecutive damages arising from the LEDiL products being used outside of the recommended temperature range.