

Multilayer Chip Bead Array Inductors (BK array series)

BK20104M431-T

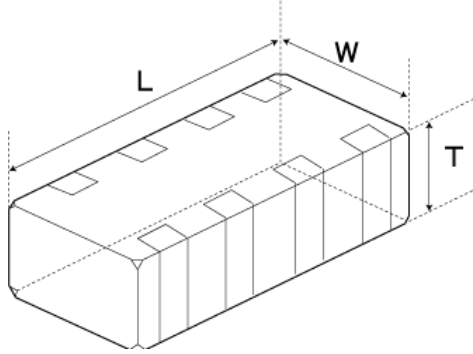

■ Features

- Item Summary
430Ω, 100mA, 0804
- Lifecycle Stage
Mass Production
- Standard packaging quantity (minimum)
Taping 4000pcs

■ Products characteristics table

CaseSize (EIA/JIS)	0804/2010
Impedance	430Ω
Impedance Measuring Frequency	100MHz
Rated Current	100mA
DC Resistance (max)	0.55Ω
Temperature Range	-55°C to 125°C
RoHS Compliance	Yes
Halogen Free	Yes
Soldering Method	Reflow

■ External Dimensions

L	2mm ±0.15
W	1mm ±0.15
T	0.45mm ±0.05
e	0.25mm +0.15:-0.1

■ Typical Characteristics Fig.

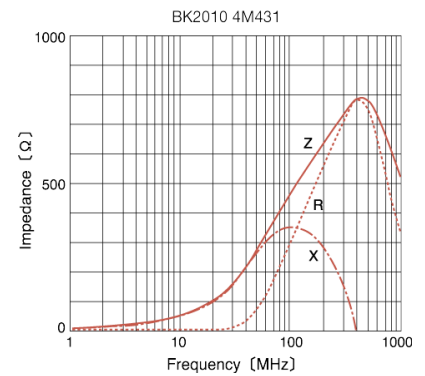

The data is reference only. Electrical characteristics vary depending on environment or measurement condition. TAIYO YUDEN reserves the right to make change to the Date at any time without notice. Before making final selection, please check product specification.