

# **M38 IP Camera Module User's Guide**

(Version 1.5)

## Preface

Congratulations on your purchase of this product. Read this manual carefully and keep it in a safe place for any future reference.

## About this manual

This user manual has been designed to help you make the most of your IP camera and its many features and functions. Information in this document has been carefully checked for accuracy; however, no guarantee is given to the correctness of the contents. The information in this document is subject to change without notice.

## Copyright

© Copyright 2011

This manual contains proprietary information, protected by copyright. All rights reserved.

## Contact Information

Leopard Imaging Inc.

1130 Cadillac CT

Milpitas, CA 95035

Phone: (408) 263-0988

Fax: (408) 217-1960

Email: [sales@leopardimaging.com](mailto:sales@leopardimaging.com)

Technical Support: [support@leopardimaging.com](mailto:support@leopardimaging.com)

Web site: [www.leopardimaging.com](http://www.leopardimaging.com)



## Contents

Introduction.....	4
Package contents.....	4
1. Product Introduction.....	5
1.1 Product outline.....	5
1.2 Key features.....	5
1.3 Technical Spec.....	6
2. Product Views.....	7
2.1 User Interface.....	7
2.2 Product Dimensions.....	8
2.3 Module BOM.....	9
3. System Installation.....	9
3.1 Operating Environment.....	9
3.2 System installation.....	10
4. Internet Explorer.....	10
4.1 Preparation.....	10
4.2 Accessing the video preview.....	12
4.3 IE Interface Overview.....	13
4.4 Settings.....	15
I. Image Setting.....	15
II. Video Setting.....	20
III. Video Analytics.....	26
IV. Audio Setting.....	28
V. Time Setting.....	29
VI. Network Setting.....	30
VII. Alarm Setting.....	33
VIII. RsPort.....	36
IX. System Maintenance.....	38
X. Recording Management.....	40
XI. About Product.....	41
5. FAQ.....	43
5.1. Client software can not access the network video server.....	43
5.2. The video server cannot be found by terminal configuration tool.....	43
Appendix.....	44
A1. How to enable the UPnP in Windows XP.....	44
A2. Milestone XProtect.....	44
A3. M38 IP Camera Module Interface.....	52
A4. Install Add-on to get the IE Interface.....	65
A5. How to use WIFI.....	67
A6. Streaming video via RTSP on VLC.....	69



## Introduction

This section covers unpacking your new IP camera Module, its key features, and basic technical information about the product. Refer to later chapters for information on setting up and configuring the product in more detail.

## Package contents

The package should contain all the following contents. If anything is missing or appears damaged, contact your dealer immediately.

1. M38 IP Camera Module (1)
2. 12V DC Power Adapter (1)
3. Interface Cable (1)
4. User's Guide (1)
5. Certificate and Warranty Card (1)

Optional Accessory:

1. PoE Board
2. WIFI Module
3. Back Interface Board



## 1. Product Introduction

### 1.1 Product outline

Leopard Imaging M38 IP camera is the next-generation IP Camera with different sensor boards from different manufacturers. It outputs full HD Video in H.264, MPEG-4, MJPEG and other video format at 30 frames per second, which makes clear images achievable even under high-contrast, low-light environment. The Leopard M38 IP Camera is ONVIF compliant and can be easily integrated into security systems.

### 1.2 Key features

- 1080P/720P Full HD video output at 30 frames per second
- Support single / dual media streaming output
- Support face detection (optional)
- Support motion detection, alarm linkage
- Support image enhancement, low-light treatment
- Optional PoE support
- Optional WIFI support
- ONVIF Compliance
- Standard H.264 video compression format
- Standard G.711 audio compression format
- Support 1080P, 720P, D1 resolution
- Built-in Web Server, fully support monitor, configure and manage via IE
- Dynamic frame rate control, real-time audio and video on the Internet to ensure transmission
- Support the adjustment of image parameters



# M38 IP Camera Module User's Guide

## 1.3 Technical Spec

	1080p	720p
<b>Image Input</b>		
Sensor	HD CMOS	
Day/Night	Auto Switch (Optional Feature)	
Active Pixels	About 200M	About 100M
e-shoot	1/2 to 1/10,000 s	
Image Enhance	Auto Gain, Auto Exposure, Auto White Balance	
Lens	Fix focus, IRIS support, C/CS mount lens support	
<b>Image Process</b>		
Resolution	1920x1080, 1280x720, D1	1280x720, D1
Format &Frame Rate	H264: 30f/s	
<b>Video Analytics</b>		
Motion Detection	Support	
Face Detection	Support (optional)	
<b>Audio</b>		
Encoding	G.711	
<b>Network</b>		
Protocols	TCP/IP, ARP, ICMP, HTTP, FTP (client/server), SMTP, DHCP, DNS, NTP, RTP/RTCP	
Wireless	Support (Optional WIFI Module)	
Protocol	ONVIF	
Authentication	IEEE802.1X	
UPnP protocol	Support	
Zero configuration protocol	Support	
<b>Interfaces</b>		
Network	10BASE-T/100BASE-TX (RJ-45)	
Serial Port	RS-485 (PELCO D protocol)	
Extension Storage	SD card x 1	
Alarm In/Out	x1 Input, x1 Output	
Audio In/Out	External Audio Input / Output Interface	
<b>Work Environment</b>		
Weight	36gram	
Dimensions	38mm(L)*38mm(W)*26mm(H)	
Power Supply	PoE (Optional), DC12V	
Power Consuming	<4w	
Temperature & Humidity	-20°C~ 45°C; 10% ~ 80% no condense	
<b>Video Management Software on PC</b>		
OS	Microsoft Windows XP/Vista/Win7/Win8/Win8.1	
Browser	Internet Explorer6.0 or above	
Other Software	<ul style="list-style-type: none"> <li>▪ Milestone XProtect (3rd party software, see <a href="#">Appendix 2</a>)</li> <li>▪ VLC Media Player (see <a href="#">Appendix 6</a>)</li> <li>▪ Any other software which support Onvif protocol</li> </ul>	



## 2. Product Views

### 2.1 User Interface

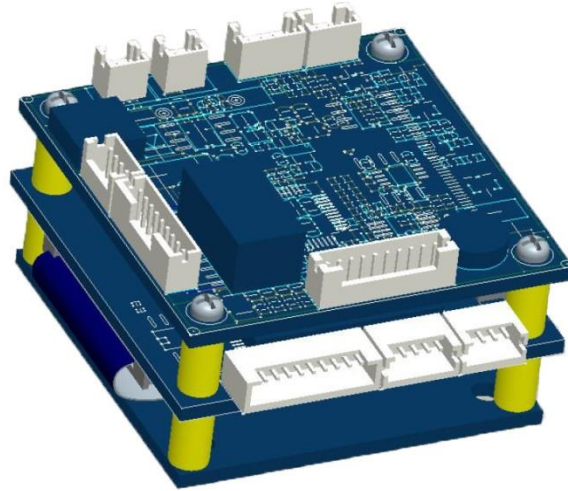

Figure 1: User Interface

Interface		Description
Power	J8	Power interface, DC 12V from external power supply or PoE
Network	J1	Network interface, Connect to RJ45 LAN connector
Audio	J19	Audio interface, Audio input and output
Video	J19	Video interface, Video Output
IR-CUT	J18	IR-CUT interface, Connect to IR cut switch or Lens with IR cut
Power of IR LED	J3	IR LED Power interface, Connect to IR LED board
IR LED Control	J6	IR LED Control interface, Connect to IR LED board
IRIS	J10	IRIS interface, Connect to Auto IRIS Lens
Software Reset	J2	Connect to Reset button, Reset software to factory default setting
Status LED	J2	Connect to system status LED
ALARM	J2	Alarm interface, Alarm input and output
RS485	J2	RS485 control interface, RS485(-) and RS485(+)
WIFI	J14	WIFI interface, Connect to WIFI module
SD Card	J23	SD card interface, Connect to SD card adapter board
PoE	J7	PoE interface, Connect to PoE board
Debug	J25	Debug interface, Connect to debug board and serial cable

Note: For more detailed information about the Interfaces, please refer to [Appendix 3](#).



## 2.2 Product Dimensions (mm)

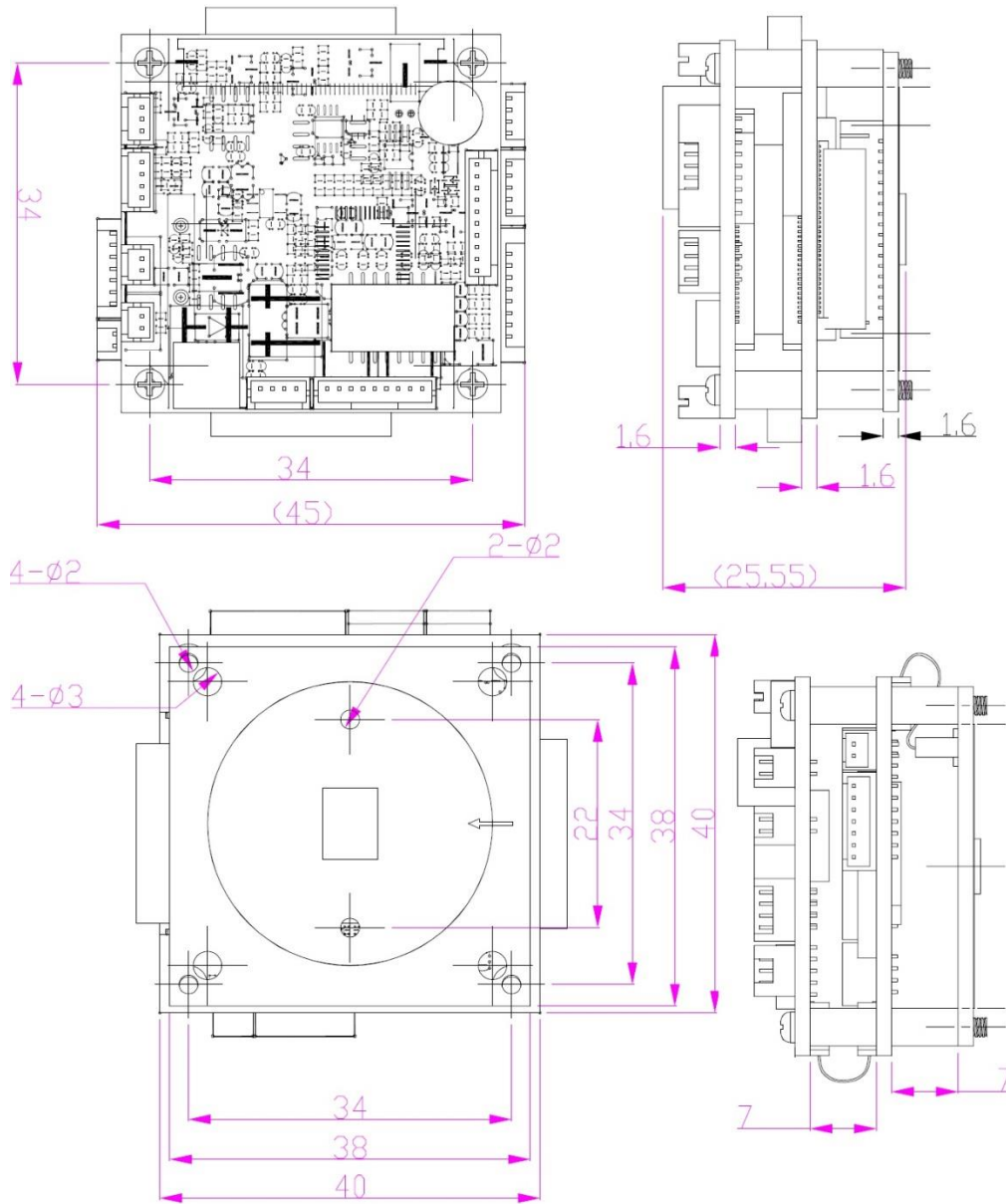



# M38 IP Camera Module User's Guide

## 2.3 Module BOM

CONFIDENTIAL  
 DRAWING FOR TOOLING

Assembly Process Instruction Summary

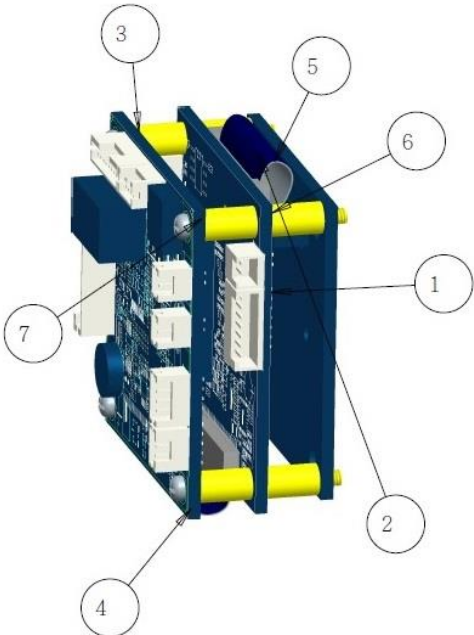

BOM				
Item	Name	Type	P/N	Q'ty
1	IPCAM-TE-MB	ASSEMBLY		1
2	SENSE-BOARD	PART		1
3	IPCAM-TE-INTERFACE	ASSEMBLY		1
4	CABLE40	PART		1
5	CABLE-36	PART		1
6	HINGE-M2X7-3	PART		8
7	M2X5	PART		4

NO.	COMMENTS FOR REVISION			REV	DATE
MODEL:	DWG NAME:		REVISION	SHEET	
	IPCAM_TE			1/1	
DRN	MATERIAL		DESCRIPTION		
DSN	FINISH		UNIT	mm	
RWD			SCALE 0.500		
APP'D	Leopard Imaging		DRAWING NO.		

## 3. System Installation

### 3.1 Operating Environment

The IP Camera video streaming can be viewed on a PC with Windows XP (or higher) OS via the TCP/IP protocol.



## 3.2 System installation

1. Connect the IP Camera to the network or directly to PC via Ethernet cable.
2. Connect the 12V DC Power to the camera.

## 4. Internet Explorer

### 4.1 Preparation

1. Connect the M38 module directly to a PC with the Ethernet cable. Power on the camera with the 12V DC power supply provided.

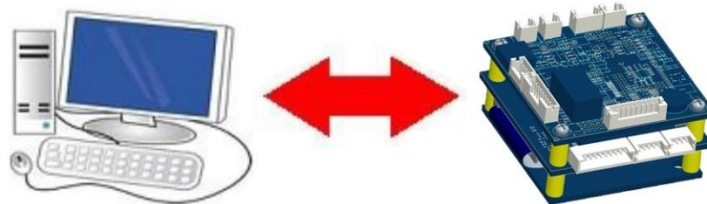

2. On Windows 7, go to Control Panel\Network and Sharing Center; Click “Local Area Connection” and then click “Properties”. On Windows XP, go to Control Panel\Network and Internet\Network Connections. Right click on the corresponding Network adapter and then click “Properties”.
3. In Local Area Connection Properties, Click Internet Protocol Version 4 (TCP/IPv4) Properties.

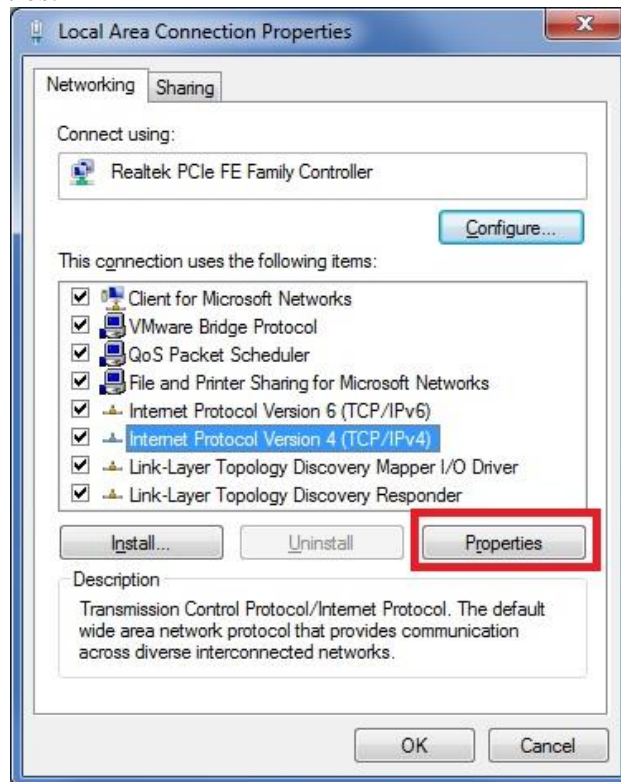

4. Specify IP address and DNS server as in the screenshot below.

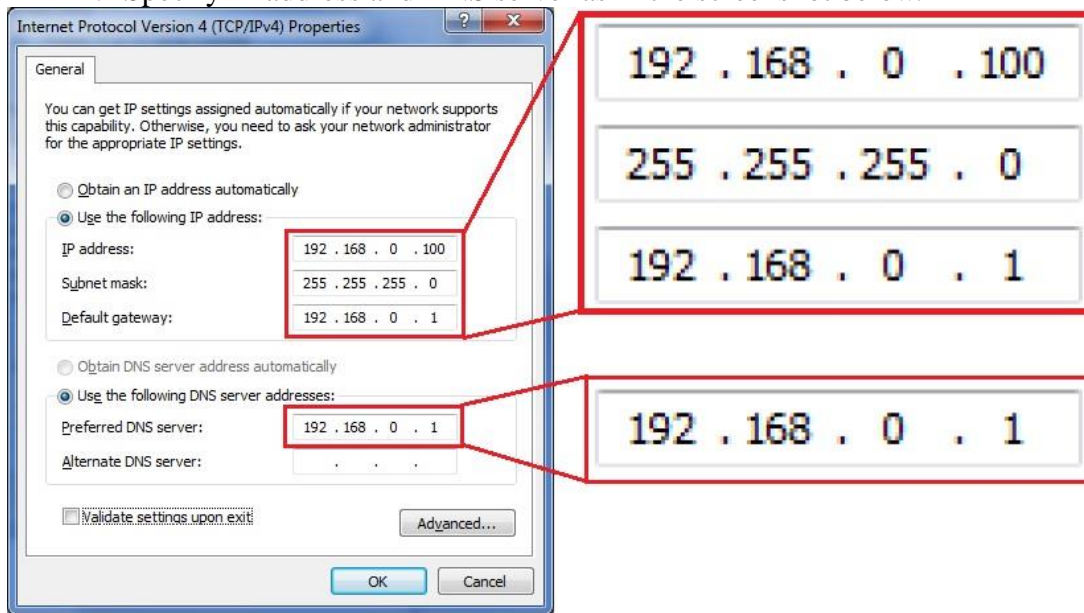

Figure 2: Set static IP

5. If necessary, wait for around 45 seconds for the IP Camera to boot up.
6. Open Internet Explorer, browse for the IP address of the M38 IP Camera (<http://192.168.0.168/>).
7. You should see a login Window where you can enter the username and Password.  
User Name: admin  
Password: admin
8. If you run this camera at the first time, you may not be able to see the live video before you install ActiveX. Please refer to [Appendix 4](#) to install the ActiveX control.

**Note:** The default IP address is static IP 192.168.0.168. You can change the static IP address or set network setting to DHCP in Web Interface.

The IP Camera can also be connected to a network:



To connect the IP Camera to a network via a Router:

- Make sure the client PC with correct OS is also connected to the same network.
- Connect the external Power to the IP Camera.
- The router will assign an IP address to the IP Camera.
- The IP Camera will show up on the PC as a UPnP device.

UPnP device can be found in File Explorer → Network (left Pane) → Other Devices.



## 4.2 Accessing the video preview

To access the video preview, please follow the steps below:

1. Input the IP address to IE, and you will get the following interface:



Figure 3: Login Interface

2. In order to complete the installation of the Control successfully through the browser, the version of IE must be upgraded to 6.0 or above.
3. Enter user Name: admin
4. Enter password: admin
5. Click “OK”. You will the get to the video preview as show below:

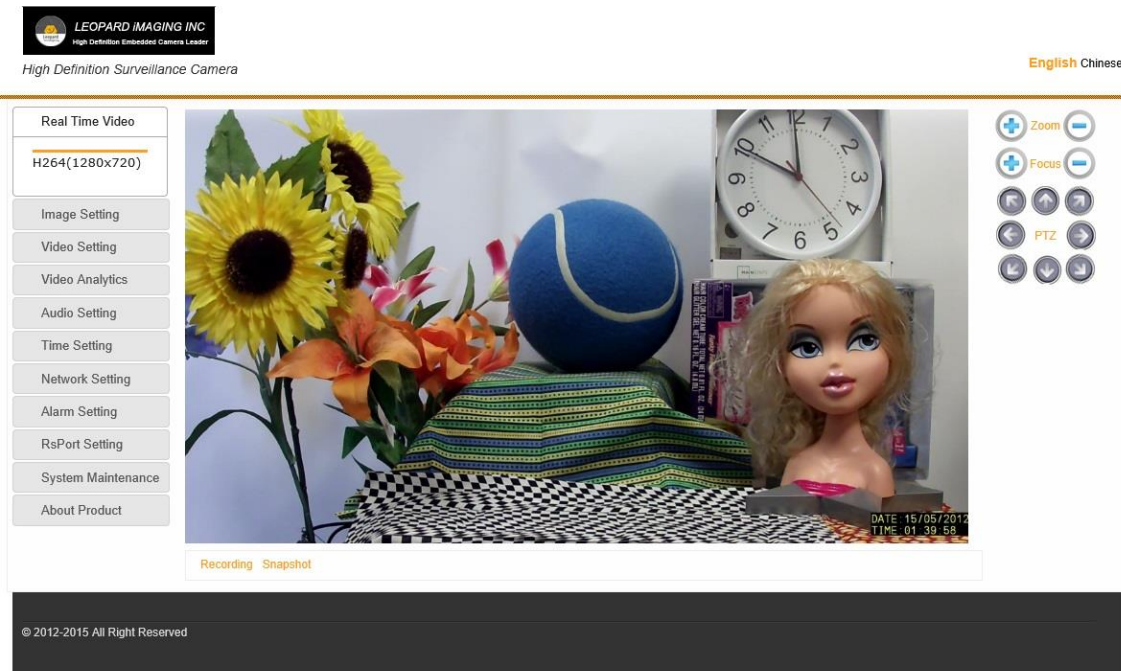

Figure 4: Live Video Interfaces



## 4.3 IE Interface Overview

The Window displays real-time video images, as shown in Figure 4.

The Client interface includes:

- ❖ Live video Preview.
- ❖ Navigation interface on the left part of the webpage, shown in Figure 5. These Interfaces will be introduced in detail in the following sections.

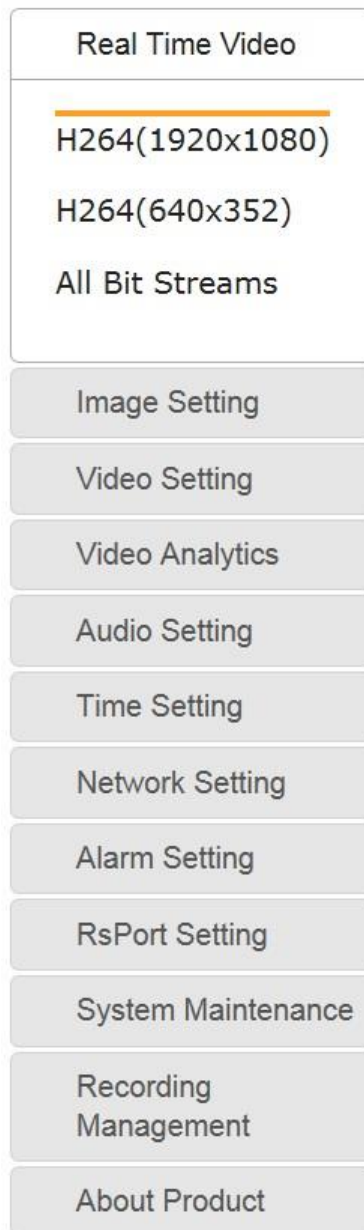

Figure 5: Navigation Interface



- ❖ PTZ interface on the right of the webpage.



Figure 6: PTZ Interface

- Zoom: Zoom level is from 1 to 18. Click “+” or “-” to adjust the zoom level. Auto Focus function will be enabled during zooming.
  - Focus: Click “+” or “-” to focus the camera manually. Focus Step is from 2 to 30.
  - PTZ: Click the arrow buttons to adjust the PTZ. Auto Focus function will be enabled when adjust the PTZ.
- ❖ Recording and Snapshot

Note: When use the Recording function, please run IE as Administrator.

- Start recording: After click “Start recording”, video will be saved to your PC; Click again, video recording will stop. A window will pop up to show the path of the saved video.
- Snapshot: After click “Snapshot”, you will capture an image.



Figure 7: Recording and Snapshot

## 4.4 Settings

### I. Image Setting

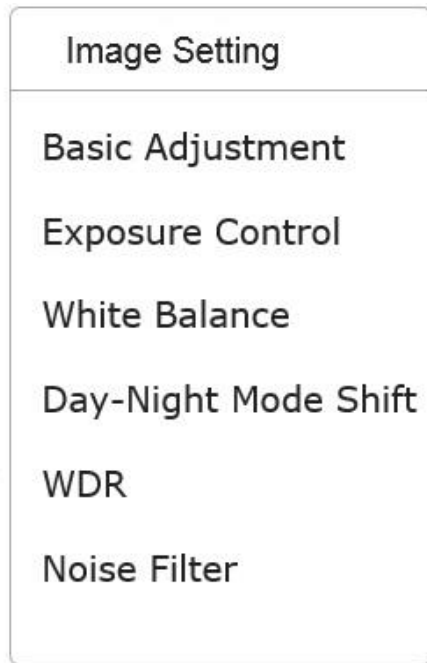

Figure 8: Image Setting

#### ❖ Basic Adjustment

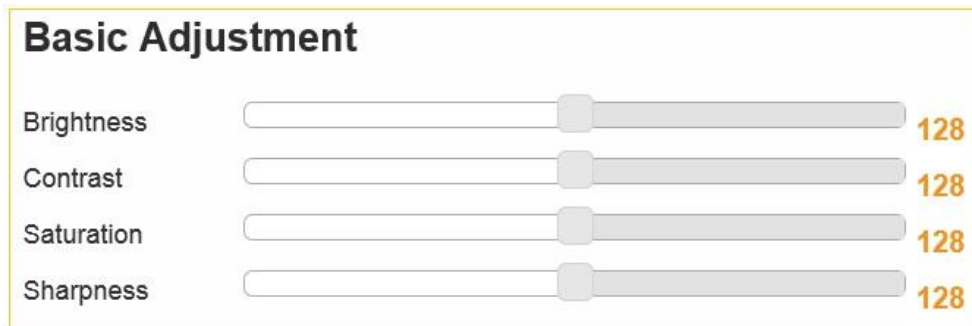

Figure 9: Basic Adjustment

- Brightness: Scroll bar to control brightness. (value ranges from 1 to 255)
- Contrast: Scroll bar to control contrast. (value ranges from 1 to 255)
- Saturation: Scroll bar to control saturation. (value ranges from 1 to 255)
- Sharpness: Scroll bar to control sharpness. (value ranges from 1 to 255)

#### ❖ Exposure Control

- Auto Exposure



### Exposure Control

**Auto Exposure**

Min Frame Rate  ▼

Max Gain  ▼

Max Digital Gain  ▼

Auto Iris  Open  Close

Flicker Control  ▼

**Manual Exposure**

Figure 10: Auto Exposure

- Minimal Framerate: Use the pull-down list to choose the minimal framerate.
  - 30
  - 25
  - 15
  - 8
  - 1
- Max Gain: 1 ~ 10
- Max Digital Gain:
  - 1024
  - 2048
  - 4096
  - 8191
- Auto Iris: Open/ Close
- Flicker Control: Use the pull-down list to choose the anti-flicker frequency
  - 60hz flicker
  - 50hz flicker



- Manual Exposure:

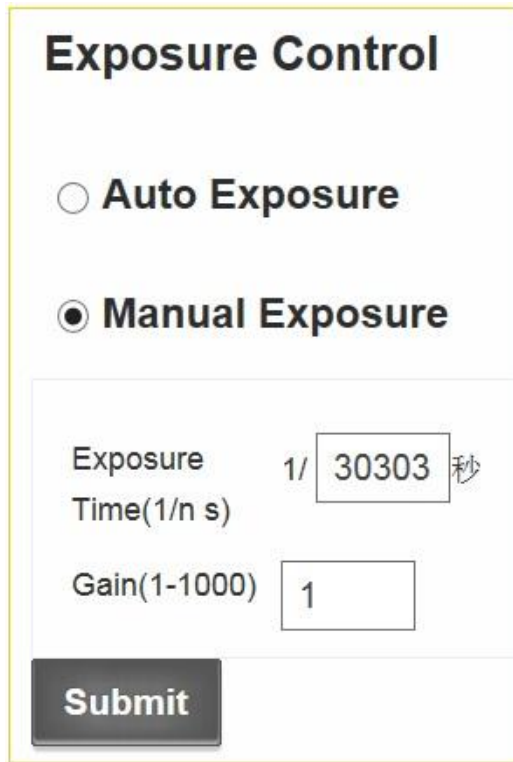

**Exposure Control**

Auto Exposure

Manual Exposure

Exposure Time(1/n s) 1/ 30303 秒

Gain(1-1000) 1

**Submit**

Figure 11: Manual Exposure

- Exposure Time
- Gain: 1 ~ 10

- ❖ White Balance: Open/Close

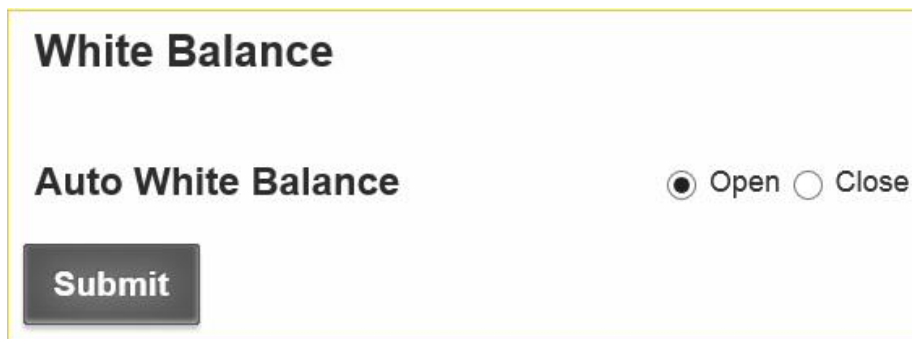

**White Balance**

**Auto White Balance**  Open  Close

**Submit**

Figure 12: Auto White Balance



## ❖ Day Night Mode Setting

### Day Night Shift

Manual

Dynamic

D-N shift value (1-45)  20

N-D shift value (1-45)  40

Depend on photosensitive sensor

**Submit**

Figure 13: Auto Day-night mode shift

- Manual: The day/night mode can be set manually.
  - Day
  - Night
- Dynamic: The day/night mode can auto switch depending on the brightness.
  - Min Brightness(1- 45): when the brightness is lower than min, night mode will open
  - Max Brightness(1- 45): when the brightness is higher than max, day mode will open
- Depend on photosensitive sensor
  - High When Day
  - High When Night

## ❖ WDR



**WDR**

No WDR

Low strength

Medium strength

High strength

**Save**

Figure 14: WDR

- No WDR
- Low strength
- Medium strength
- High strength

## ❖ Noise Filter

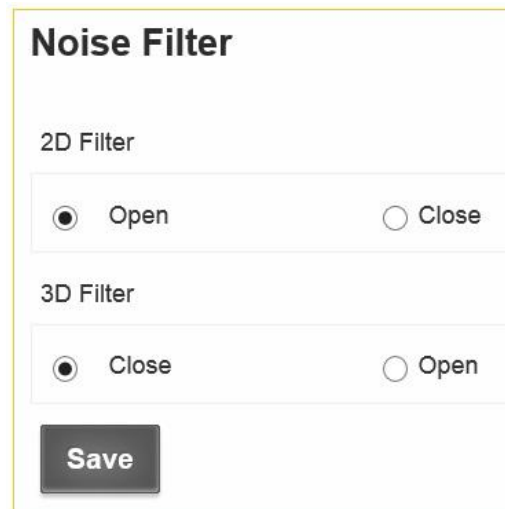

**Noise Filter**

2D Filter

Open  Close

3D Filter

Close  Open

**Save**

Figure 15: Noise Filter

- 2D Filter: Close / Open
- 3D Filter: Close / Open



## II. Video Setting

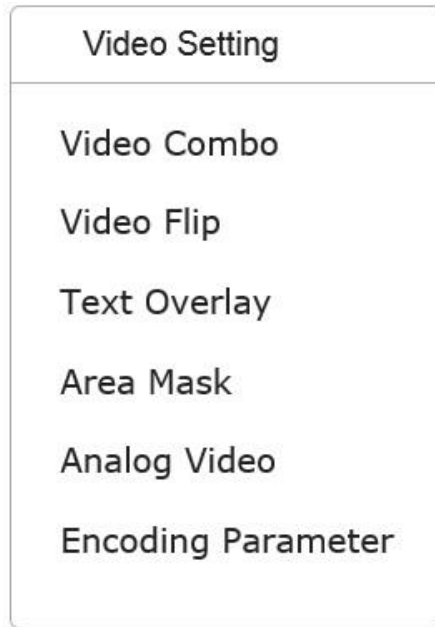

Figure 16: Video Setting

### ❖ Video Combo

- Main stream

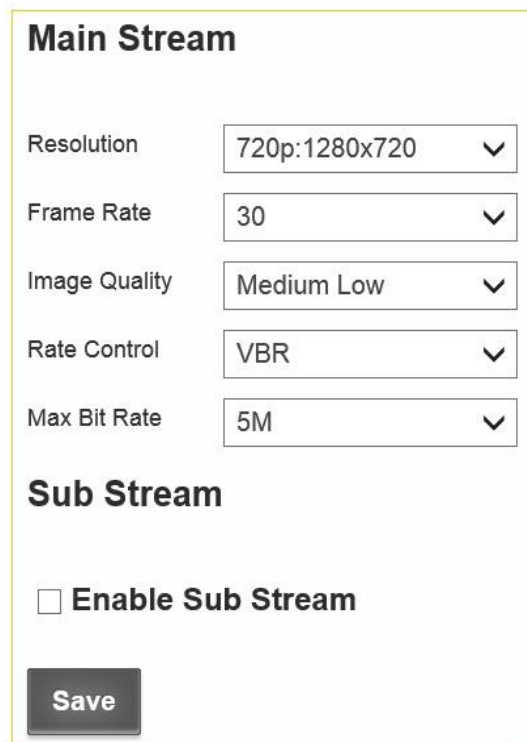

Figure 17: Main stream



- Resolution:
    - 1080p: 1920x1080
    - 720p: 1280x720
    - D1: 704x576
  - Framerate: 1~30
  - Image Quality:
    - High
    - Medium High
    - Medium
    - Medium Low
    - Low
    - Very Low
  - Rate Control
    - VBR
    - CBR
  - Max Bit-rate
    - 5M
    - 4M
    - 3M
    - 2M
- Sub stream

### Sub Stream

**Enable Sub Stream**

Resolution	VGA:640x352	▼
Frame Rate	30	▼
Image Quality	Medium Low	▼
Rate Control	VBR	▼
Max Bit Rate	1M	▼

**Save**

Figure 18: Sub stream

- Enable Sub stream: After Enable Sub stream, go to “Live video” and click the stream name to refresh it, you will get two steam names.



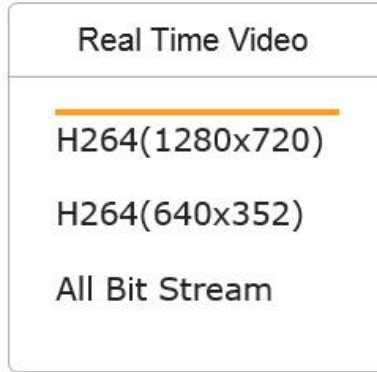

Click “All Bit Streams”, you will get two live videos on the interface.

- Resolution:
  - D1: 704x576
  - VGA: 640x352
  - QVGA: 320x192
- Framerate:
  - 30
  - 25
  - 16
  - 8
  - 1
- Image Quality:
  - High
  - Medium High
  - Medium
  - Medium Low
  - Low
  - Very Low
- Rate Control
  - VBR
  - CBR
- Max Bit-rate
  - 2M
  - 1M
  - 512KB

## ❖ Video Flip

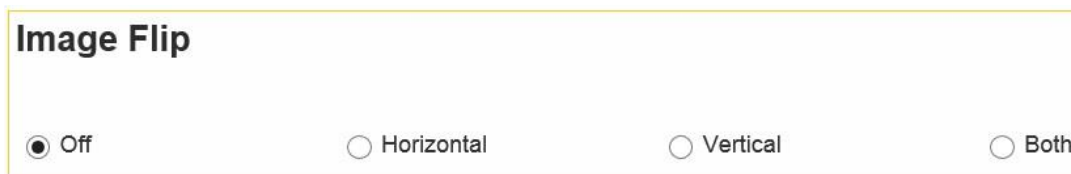



Figure 19: Video Flip



- OFF
- Horizontal
- Vertical
- Both

## ❖ Text Overlay



**Overlay Setting**

Enable	Content	Position	Offset X	Offset Y
<input type="checkbox"/> Main Stream	<input type="text" value="IPNC"/>	<input type="text" value="Lower Right"/>	<input type="text" value="0"/>	<input type="text" value="0"/>
<input type="checkbox"/> Sub Stream	<input type="text" value="IPNC"/>	<input type="text" value="Lower Left"/>	<input type="text" value="0"/>	<input type="text" value="0"/>

**Time Overlay**

Enable	Date Format	Time Format	Position
<input checked="" type="checkbox"/>	<input type="text" value="YYYY/MM/I"/>	<input type="text" value="24Hrs"/>	<input type="text" value="Lower Right"/>

Figure 20: Text Overlay

- Main stream overlay
  - Enable
  - Text
  - Position
    - Lower-left corner
    - Lower-right corner
    - Upper-left corner
    - Upper-right corner
  - Offset X
  - Offset Y

- Sub stream overlay
    - Enable
    - Text
    - Position
      - Lower-left corner
      - Lower-right corner
      - Upper-left corner
      - Upper-right corner
    - Offset X
    - Offset Y
  - Time
    - Enable
    - Date Format
      - YYYY/MM/DD
      - MM/DD/YYYY
      - DD/MM/YYYY
    - Time Format
      - 12 Hrs
      - 24 Hrs
    - Position
      - Lower-left corner
      - Lower-right corner
      - Upper-left corner
      - Upper-right corner
- ❖ Area Mask

Apply
Reset

---

**Block Mask**

Enable	X	Y	Width	Height	Operate
<input type="checkbox"/>	<input style="width: 40px;" type="text" value="0"/>	<input style="width: 40px;" type="text" value="0"/>	<input style="width: 40px;" type="text" value="0"/>	<input style="width: 40px;" type="text" value="0"/>	Edit
<input type="checkbox"/>	<input style="width: 40px;" type="text" value="0"/>	<input style="width: 40px;" type="text" value="0"/>	<input style="width: 40px;" type="text" value="0"/>	<input style="width: 40px;" type="text" value="0"/>	Edit
<input type="checkbox"/>	<input style="width: 40px;" type="text" value="0"/>	<input style="width: 40px;" type="text" value="0"/>	<input style="width: 40px;" type="text" value="0"/>	<input style="width: 40px;" type="text" value="0"/>	Edit
<input type="checkbox"/>	<input style="width: 40px;" type="text" value="0"/>	<input style="width: 40px;" type="text" value="0"/>	<input style="width: 40px;" type="text" value="0"/>	<input style="width: 40px;" type="text" value="0"/>	Edit

Figure 21: Area Mask

There are two ways to select the area mask. Quick select and Value input select  
Up to 4 area masks can be set on the video.

- ❖ Quick select
  - 1) Check “Enable” and click “Edit” on the right.





- 2) Drag mouse on the video to select the area mask.
  - 3) Click "Apply".
- ❖ Value input select
    - 1) Check "Enable".
    - 2) Input the values of X, Y, Width and Height, then click "Edit".
    - 3) Click "Apply".
  - ❖ Clean area mask
    - 1) Click "Edit" of the area mask you want to remove.
    - 2) Click "Reset".
    - 3) Click "Apply".
- 
- ❖ Analog Video

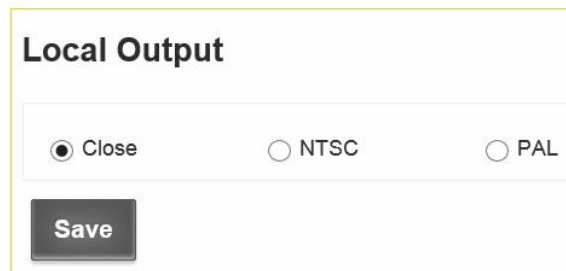

**Local Output**

Close       NTSC       PAL

**Save**

Figure 22: Analog Video

- OFF
- NTSC
- PAL

- ❖ Encoding Parameter

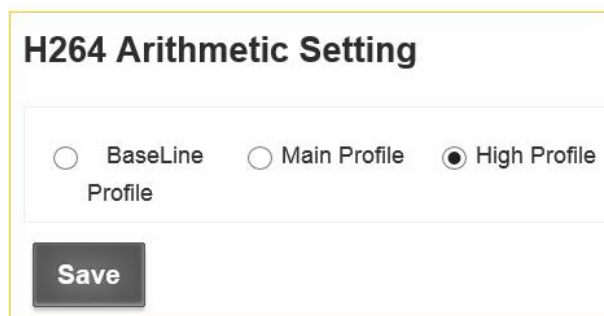

**H264 Arithmetic Setting**

BaseLine Profile       Main Profile       High Profile

**Save**

Figure 23: Encoding Parameter

- BaseLine Profile
- Main Profile
- High Profile

## III. Video Analytics



Figure 24: Video Analytics

### ❖ Face Detection (Optional)

A screenshot of a web interface for configuring face recognition and privacy mask settings. The interface is divided into two main sections: "Face Recognition" and "Privacy Mask".  
**Face Recognition Section:**  
- "Face Recognition" is set to "Off" via a dropdown menu.  
- "Region of Interest" is configured with x: 0, y: 0, w: 1280, and H: 720.  
- "Confidence Level (1-100)" is shown as a slider set to 75.  
- "Direction" is set to "Up" via a dropdown menu.  
**Privacy Mask Section:**  
- "Enable Privacy Mask" is set to "Off" via a dropdown menu.  
- "Mask Option" is set to "Black Box" via a dropdown menu.  
A "Submit" button is located at the bottom left of the form.

Figure 25: Face Detection

- Face Recognition
  - Face Detect
    - OFF
    - DETECT
    - ENHANCED DETECT
  - Region of Interest:
    - X: Enter the x-axis value of the starting pixel for ROI
    - Y: Enter the y-axis value of the starting pixel for ROI

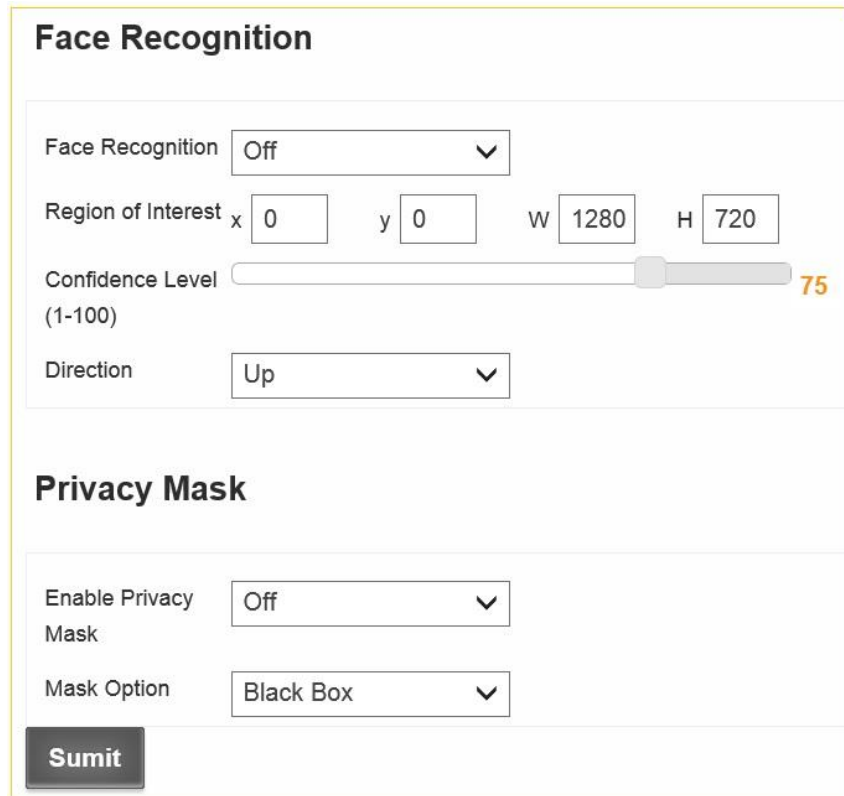

## M38 IP Camera Module User's Guide

- W: Enter the width of the ROI
- H: Enter the height of the ROI
- Confidence Level: To adjust the accuracy of the face detection algorithm. The value ranges from 1 (lowest) to 100 (highest). The default value is 75.
- Direction: To set the priority of detecting faces in the following directions
  - UP
  - LEFT
  - RIGHT
- Privacy Mask
  - Enable Privacy Mask: OFF / ON
  - Mask Option: Choose privacy mask pattern. The default value is Black Box.

### ❖ Motion Detection

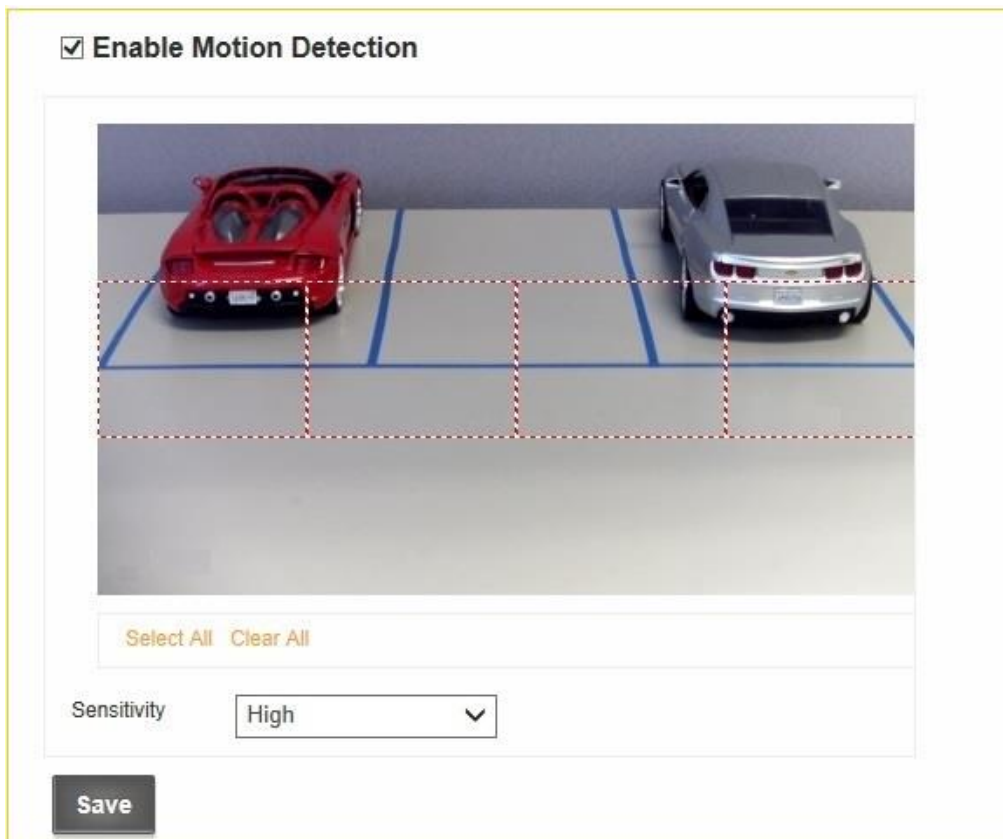

Figure 26: Motion Detection

- Click on the video interface or click “Select All” to select region of interest.
- Click “Clear All” to clear the region of interest.
- Sensitivity
  - Low
  - Medium
  - High



## IV. Audio Setting



Figure 27: Audio Setting

### ❖ Audio Input

A screenshot of the "Audio Input" configuration page. The page has a title "Audio Input" and a checked checkbox labeled "Enable Audio Input". Below this, there are several settings: "Input Gain(1-100)" is a slider set to 75; "Encoding" is a dropdown menu set to "G711"; "Sample Rate" is a dropdown menu set to "8Khz"; "Bit Rate" is a dropdown menu set to "AUTO: 64Kbps"; and "Alarm Level (1-100)" is a slider set to 50. At the bottom left, there is a "Submit" button.

Figure 28: Audio Input

- Enable Audio Input
- Input Gain: Set the input gain to adjust the volume of audio input. The range is from 1 to 100, and the minimum value does not mute the camera.
- Encoding is G711
- Sample Rate is 8Khz

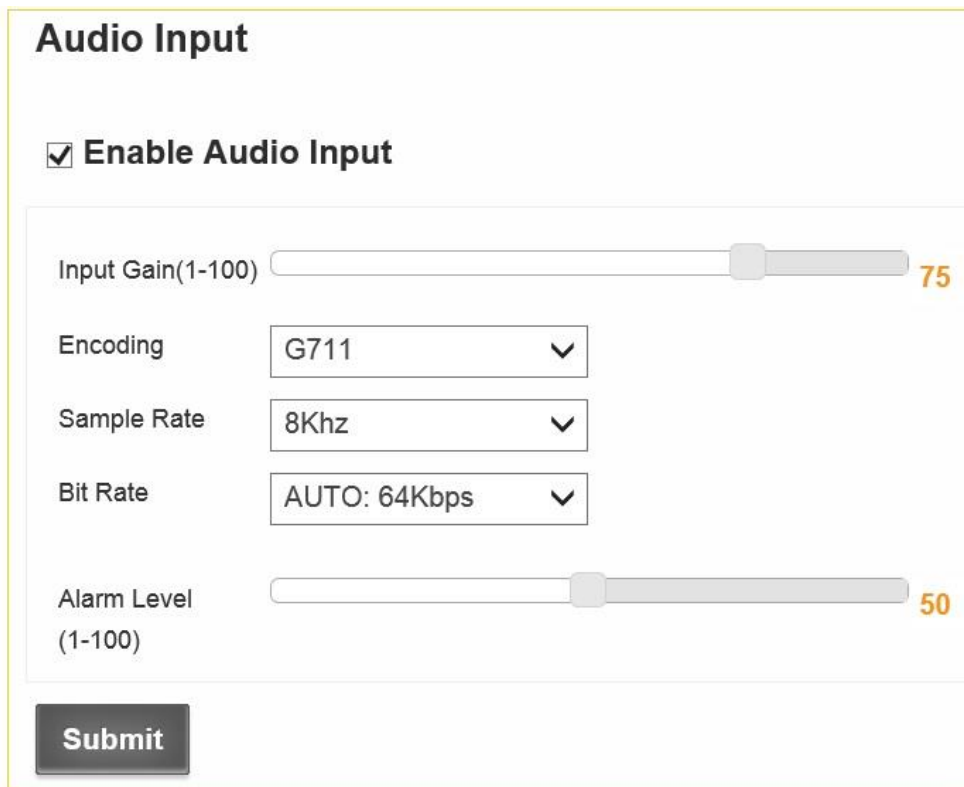

# M38 IP Camera Module User's Guide

- Bit Rate: The IP Camera supports 64Kbps bit rate.
- Alarm Level: Use the scroll bar to adjust alarm level. When the audio input reaches the alarm level, the alarm will be triggered. ( Audio Alarm function must be enabled in Alarm Setting.)

## ❖ Audio Output

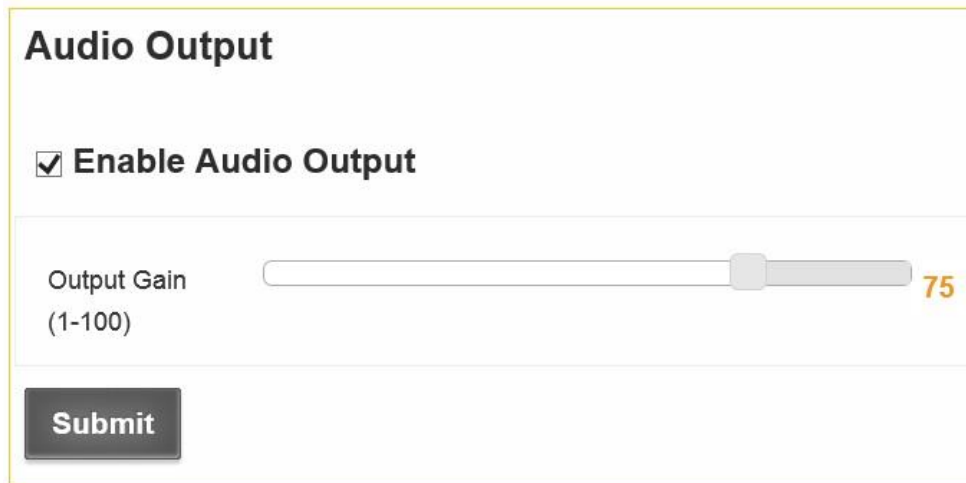

Figure 29: Audio Output

- Output Gain: Set the audio playback volume. The range is from 1 to 100

## V. Time Setting

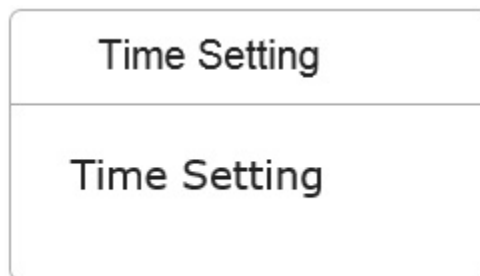

Figure 30: Time Setting

## ❖ Time Setting



## Time Setting

Time Zone

Time Setting

Synchronize with computer time

Local Time **2013/6/7 18:25:29**

Synchronize with NTP server

NTP Server IP

**Save**

Figure 31: Time Setting

- Time Zone
- Synchronize with computer time
- Synchronize with Sntp server

## VI. Network Setting

### Network Setting

LAN Setting

WIFI Access

WIFI Setting

Streaming Media

Figure 32: Network Setting



## ❖ LAN Setting

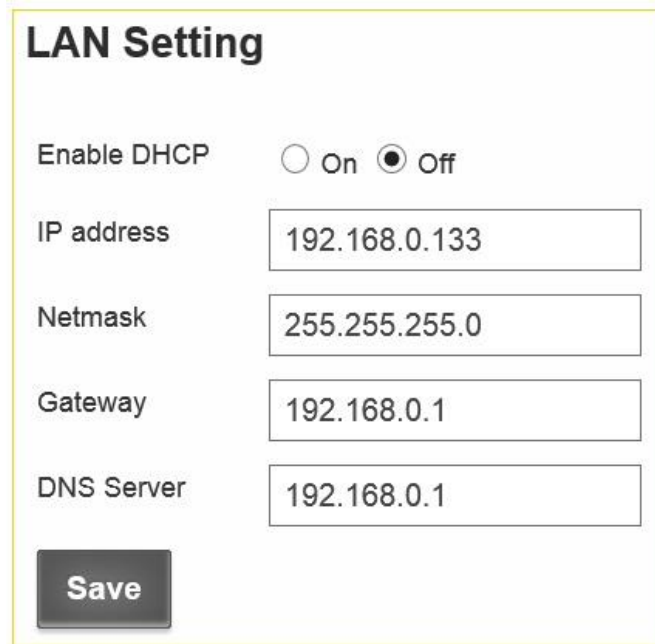

**LAN Setting**

Enable DHCP  On  Off

IP address

Netmask

Gateway

DNS Server

**Save**

Figure 33: LAN Setting

- Enable DHCP: ON / OFF
- IP address: If you disable DHCP, you can set static IP address.
- Netmask
- Gateway
- DNS Server

## ❖ WIFI Access (Optional)

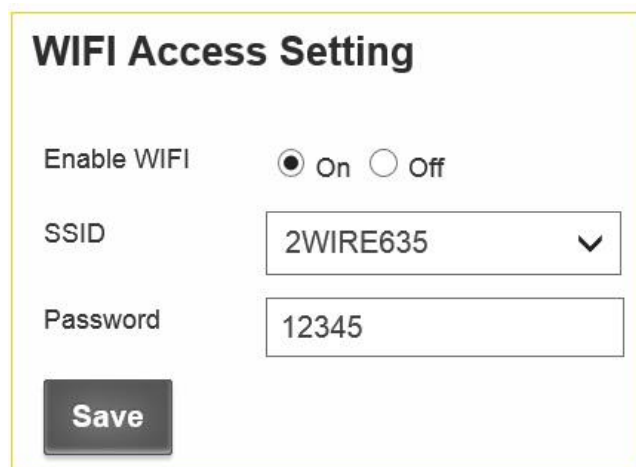

**WIFI Access Setting**

Enable WIFI  On  Off

SSID  ▼

Password

**Save**

Figure 34: WIFI Access

- Enable WIFI: ON / OFF
- SSID: WIFI ID around the camera will be shown on the pull-down list.



- Password: The password of your Wireless network  
Note: For how to use WIFI, please refer to [Appendix 5](#).

## ❖ WIFI Setting (Optional)

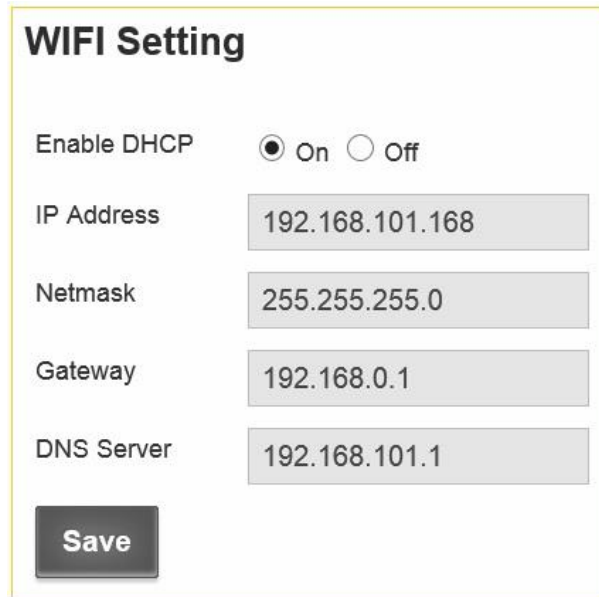

Figure 35: WIFI Setting

- Enable DHCP: ON / OFF
- IP address: If you disable DHCP, you can set static IP address.
- Netmask
- Gateway
- DNS Server

## ❖ Streaming Media

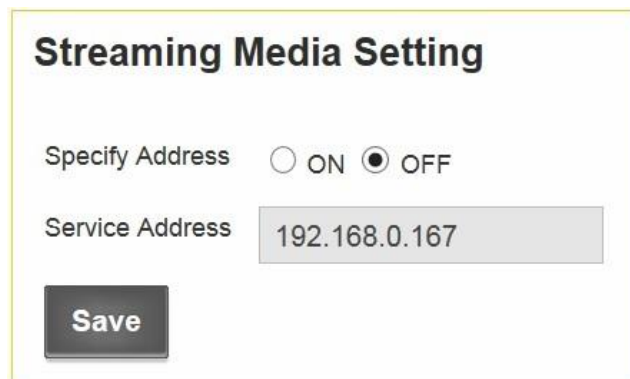

Figure 36: Streaming Media

- Specify Address
- Service Address





## VII. Alarm Setting

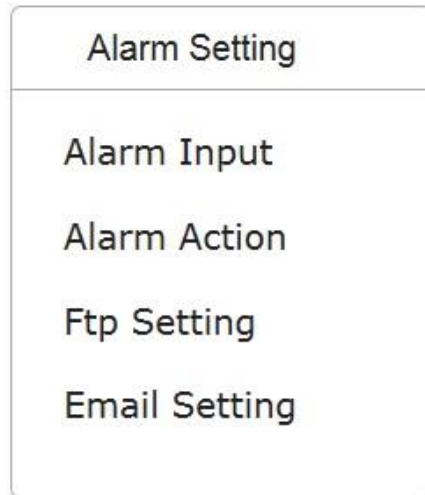
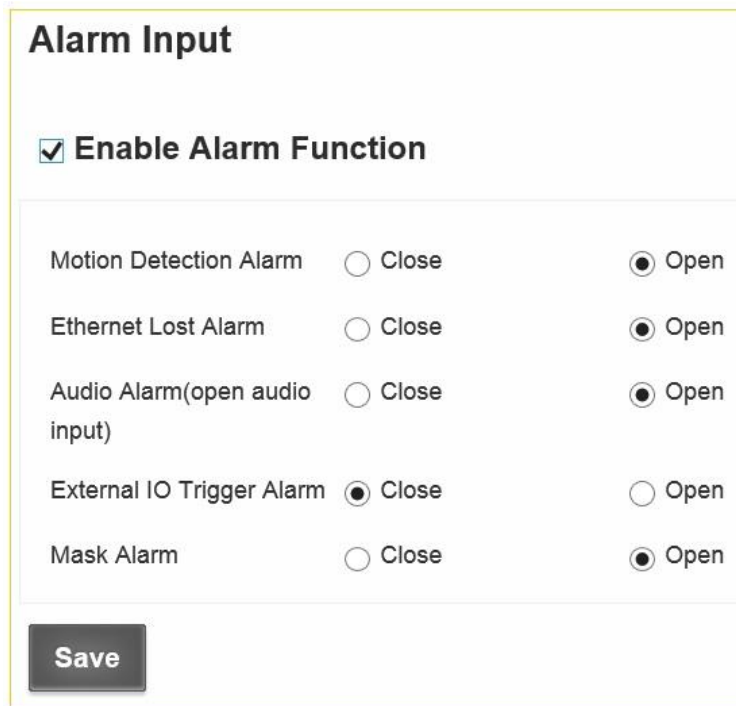

Figure 37: Alarm Setting

### ❖ Alarm Input



**Alarm Input**

**Enable Alarm Function**

Motion Detection Alarm	<input type="radio"/> Close	<input checked="" type="radio"/> Open
Ethernet Lost Alarm	<input type="radio"/> Close	<input checked="" type="radio"/> Open
Audio Alarm(open audio input)	<input type="radio"/> Close	<input checked="" type="radio"/> Open
External IO Trigger Alarm	<input checked="" type="radio"/> Close	<input type="radio"/> Open
Mask Alarm	<input type="radio"/> Close	<input checked="" type="radio"/> Open

**Save**

Figure 38: Alarm Input

- Enable Alarm
- Motion Detection
- Ethernet Lost Alarm
- Audio Alarm
- External Triggers



- Mask Alarm

## ❖ Alarm Action

### Alarm Process

Voice Play	<input type="radio"/> Close	<input checked="" type="radio"/> Open	Long Type ▾
IO Output	<input checked="" type="radio"/> Close	<input type="radio"/> Open	5 s ▾
UDP report	<input checked="" type="radio"/> Close	<input type="radio"/> Open	

Warning:Please plug in the SD card when save the alarm video

SD Storage	<input type="radio"/> Close	<input checked="" type="radio"/> Open	Main Stream ▾
FTP Storage	<input checked="" type="radio"/> Close	<input type="radio"/> Open	Main Stream ▾
Send Email	<input checked="" type="radio"/> Close	<input type="radio"/> Open	Snapshot ▾
Video Length	5s ▾	Quantity of Image	One ▾

**Save**

Figure 39: Alarm Action

- Voice Play: Close / Open
  - Short Type
  - Long Type
- IO Output: Close / Open
  - 5 s
- UDP report: Close / Open
- SD Storage: Close / Open
  - Main Sream
  - Sub Stream
  - Snapshot
- FTP Storage: Close / Open
  - Main Sream
  - Sub Stream
  - Snapshot
- Send Email: Close / Open
  - Snapshot



- Video Length
  - 5 s
  - 10 s
  - 30 s
- Quantity of Image
  - One

### ❖ FTP Setting

### FTP Setting

FTP Server	<input type="text" value="192.168.10.241"/>
FTP Port	<input type="text" value="21"/>
FTP Account	<input type="text" value="joe"/>
FTP Password	<input type="text" value="welcome"/>
FTP Directory	<input type="text" value="test"/>

Figure 40: FTP Setting

- FTP Server
- FTP Port
- FTP Account
- FTP Password
- FTP Directory

## ❖ Email Setting

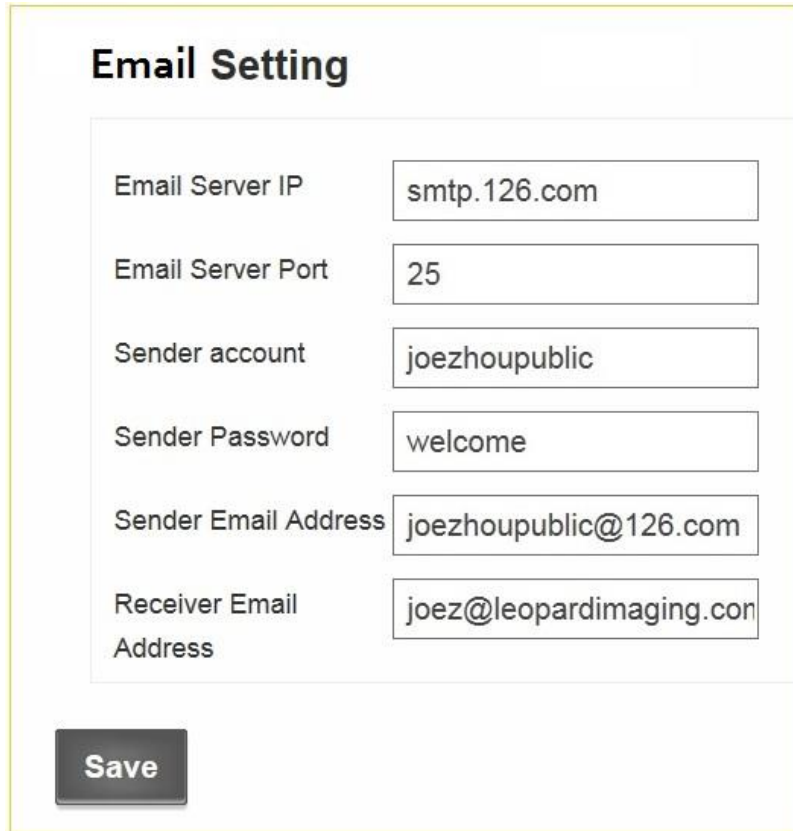

Email Server IP	smtp.126.com
Email Server Port	25
Sender account	joezhoupublic
Sender Password	welcome
Sender Email Address	joezhoupublic@126.com
Receiver Email Address	joez@leopardimaging.com

**Save**

Figure 41: Email Setting

- Email Server IP
- Email Server Port
- Sender account
- Sender Password
- Sender Email Address
- Receiver Email Address

## VIII. RsPort

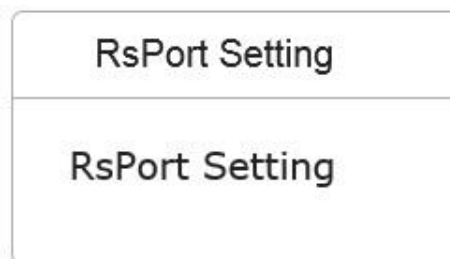

**RsPort Setting**

**RsPort Setting**

Figure 42: RsPort



## ❖ RsPort Setting

### Camera Information

Enable rs485  On  Off

Baud Rate

Data Bits

Parity Check

Stop Bits

PTZ Protocol

**Save**

Figure 43: RsPort Setting

- Enable RS485: ON / OFF
- Baud Rate
  - 19200
  - 9600
  - 4800
  - 2400
  - 1200
- Data Bit
  - 8
  - 7
  - 6
  - 5
- Parity
  - None
  - Odd
  - Even
  - Space
- Stop Bits



- 1
- 2
- Protocol
  - Pelco-d
  - Pelco-e
  - User-Defined

## IX. System Maintenance



Figure 44: System Maintenance

### ❖ Device Upgrade

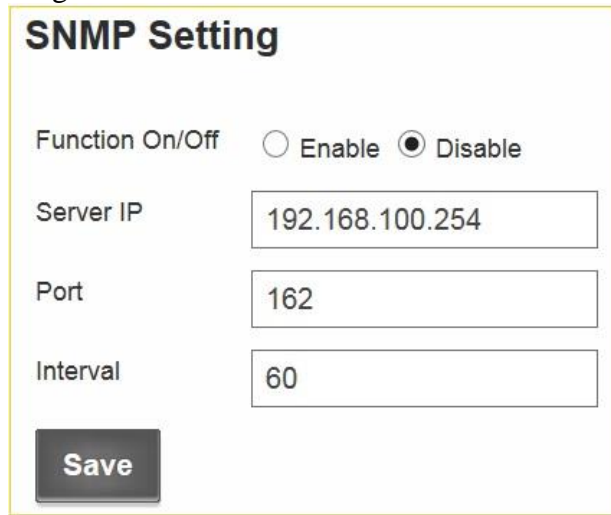

Figure 45: Device Upgrade

- ❖ Restart Camera: Click “Restart” button to restart camera.
- ❖ Restore to factory settings: Click “Submit” button to reset the camera
- ❖ Event Log: You can check the system log in this section.



## ❖ SNMP Setting



The figure shows a web form titled "SNMP Setting". It contains the following elements:

- Function On/Off:** Two radio buttons, "Enable" (unselected) and "Disable" (selected).
- Server IP:** A text input field containing "192.168.100.254".
- Port:** A text input field containing "162".
- Interval:** A text input field containing "60".
- Save:** A dark grey button with the text "Save".

Figure 46: SNMP Setting

- Function On/Off: Enable / Disable
- Server IP
- Port
- Interval

## ❖ Edit User



The figure shows a "User Account" section with a "Create User" button and a table of existing users.

User Name	Authority	Operation Option
admin	Administrator	Edit Delete

Figure 47: Edit User

- Add new user: Click "Add new user", you will get following window.



The figure shows a "Add/Edit User" form with the following fields:

- User:** A text input field.
- Authority:** A dropdown menu.
- Password:** A text input field.
- Buttons:** "Create/Edit" and "Cancel".

Figure 48: Add new user



- User: Enter the new user name
- Authority
  - Admin
  - Operator
  - Viewer
- Password: Enter the password of new user
- Edit User: Click “Edit” to edit user
- Delete User: Click “Delete” to delete user

## X. Recording Management



Figure 49: Recording Management

### ❖ Recording Plan

#### Recording Plan

SD Storage  OFF  ON Image ▼

Shared Folder Storage  OFF  ON Image ▼

Update to FTP  OFF  ON Image ▼

Repeat   End after a week  Recording always on

#### Recording Schedule

Monday	3	6	9	12	15	18	21	24
Tuesday	3	6	9	12	15	18	21	24
Wednesday	3	6	9	12	15	18	21	24
Thursday	3	6	9	12	15	18	21	24
Friday	3	6	9	12	15	18	21	24
Saturday	3	6	9	12	15	18	21	24
Sunday	3	6	9	12	15	18	21	24

Figure 50: Recording Plan





- SD Storage: OFF / ON
  - Image
  - Video
- Shared Folder Storage: OFF / ON
  - Image
  - Video
- Update to FTP: OFF / ON
  - Image
- Repeat
- Recording always on
- Recording Schedule

## ❖ SD Management

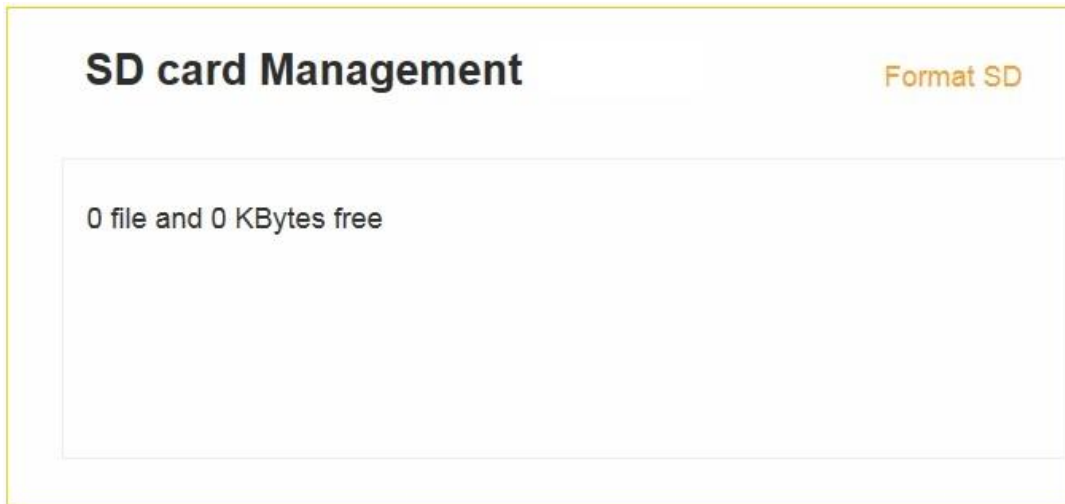

Figure 51: Recording Plan

After plug in the SD card, you can manage or format the SD card in this interface.

## XI. About Product



Figure 52: About Product



## ❖ Camera Information

### Camera Information

Camera Name	<input type="text" value="IPCAM"/>
Product Model	LI-M38-AR0331-W
Hardware Version	M38_V11
Software Version	1.2.060 build 1645
Sensor	AR0331_3.1MP

**Save**

Figure 53: Camera information

- Camera Name
- Product Model
- Hardware Version
- Software Version
- Sensor

## 5. FAQ

### 5.1. Client software can not access the network video server:

- ❖ Possible Cause: No network connection
  - *Solution*: Check the Ethernet cable first and then double check whether the problem is caused by a virus on the PC. Try to plug another device in the network to make sure the PC has network access.
- ❖ Possible Cause: Incorrect IP address entered
  - *Solution*: Double check the IP address from the server.
- ❖ Possible Cause: There is an IP conflict
  - *Solution*: Disconnect the video server and network. Connect video server and PC separately, then reset the IP address.
- ❖ Possible Cause: IP addresses are in different subnets
  - *Solution*: Check the server's IP address, subnet mask and gateway address settings.
- ❖ Possible Cause: Unknown
  - *Solution*: Restore to factory settings.

### 5.2. The video server cannot be found by terminal configuration tool:

- ❖ Possible Cause: Check whether the network works
  - *Solution*: 1.) Turn off firewall
  - *Solution*: 2.) If the device can be found, first check whether the network works. If the network works, but the network interface indicator is not a regular green light flashing, please contact our technical support engineer for equipment maintenance.



# Appendix

## A1. How to enable the UPnP in Windows XP

To enable the UPnP Protocol on Windows XP, please refer to the link below from Microsoft Support:

<http://support.microsoft.com/kb/941206>

## A2. Milestone XProtect

Milestone XProtect is a third-party software. You can try it free for 30 days and need to purchase a license if you wish to keep using it.

This guide just briefly illustrates the procedure to run LNC IP camera with Milestone XProtect. If you want more information, please refer to the user guide of Milestone XProtect, which will come with the software you download with the link below.

### 1. Download Milestone XProtect

Please use the following link to download Milestone XProtect

<http://www.milestonesys.com/Support-and-Upgrades/Technical-Support/Self-Help/downloads/>

There are different versions in the download list, and we use the Milestone XProtect Enterprise in this user guide.

### 2. Install Milestone XProtect

### 3. Run Milestone XProtect

After installation, you will get two icons on your desktop (**Milestone XProtect Management Application** and **Milestone XProtect Smart Client**).

#### 3.1 Run Management Application

Open **Milestone XProtect Management Application**.

##### 3.1.1 Add Hardware Device



# M38 IP Camera Module User's Guide

When you get the interface, click **Add Hardware Device**.

*Note: Before this step, the IP camera must be running.*



Then you will get the following window,



Select **Express** , then click **Next**.

*Note: Please refer to the user guide of Milestone XProtect if you want to use other ways to add hardware device.*



# M38 IP Camera Module User's Guide

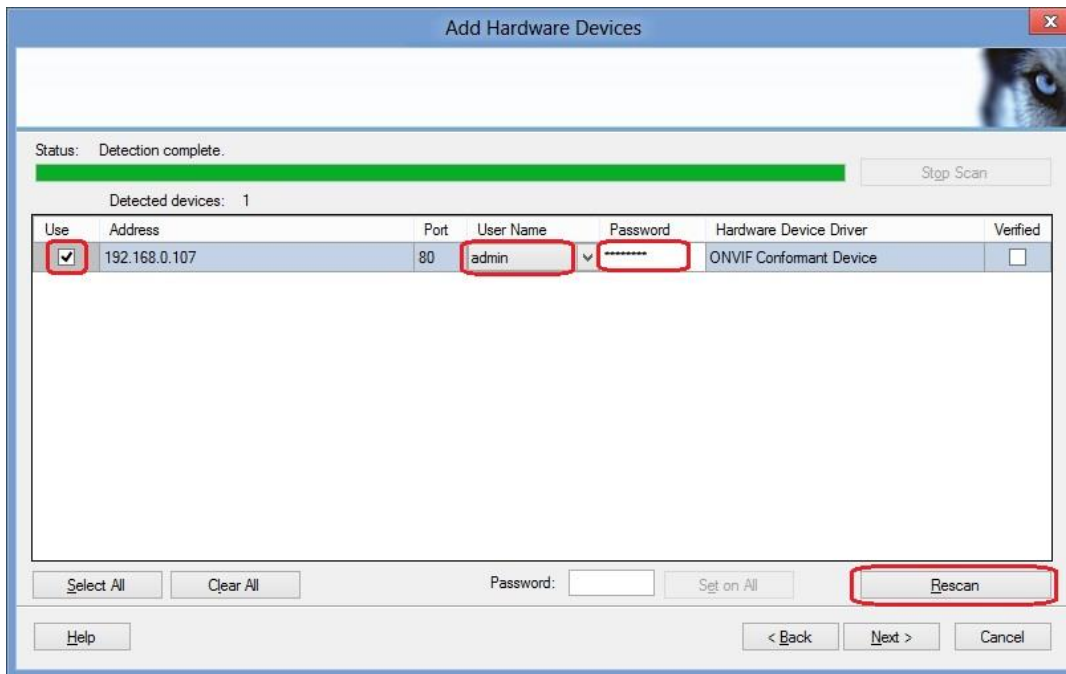

After the auto-scan gets the device, please fill in **User Name** (admin) and **Password** (9999), then check **Use** and click **Next** to verify the hardware device.

*Note: If the auto-scan can not get the device, please click **Rescan** to scan it again, or you can also use other ways in last window to get the device.*

If the device is successfully verified, you will get the following window.

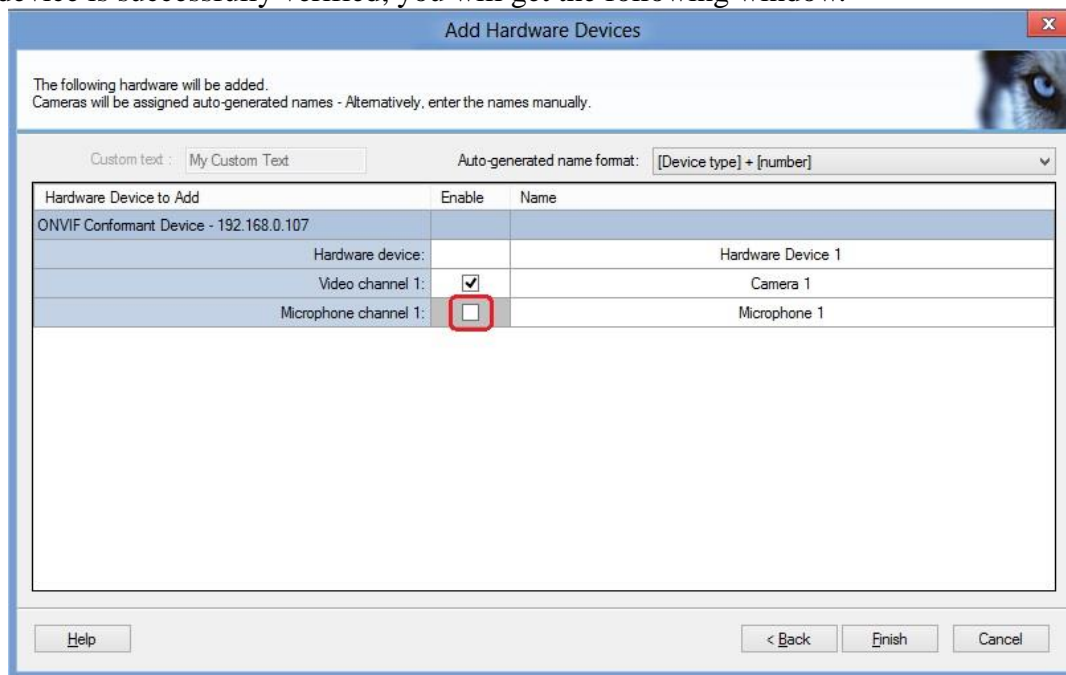

Uncheck the **Microphone channel**, then click **Finish** to add this device.



# M38 IP Camera Module User's Guide

## 3.1.2 Manage the functions

In next window, go to **Advanced Configuration** → **Hardware Devices** → **Hardware Device #** → **Camera #**, after you click **Camera #**, you will get the live video.

*Note: Hardware Device# is the hardware device you just added, for example, Hardware device 1  
Camera # is the video channel name you just added, for example, Camera 1.*

The screenshot shows the Milestone XProtect Enterprise Management Application interface. The left sidebar contains a tree view with categories like Surveillance Server, Wizards, Advanced Configuration, Hardware Devices, Cameras and Storage Information, Events and Output, Scheduling and Archiving, Matrix, Logs, E-mail, SMS, Central, Server Access, Master/Slave, Users, Services, and Alarms. The main window displays the 'Camera Settings Summary' for 'Camera 1'. The summary table is as follows:

Enabled	Camera Name	Video Format	Record on	Retention Time	Recording Path	Archiving Path
<input checked="" type="checkbox"/>	Camera 1	Querying...	Motion Detection	5 Day(s)	C:\MediaDatabase	C:\MediaDatabase

Below the table is a live video feed showing a parking lot with several cars. The video resolution is 1920x1080 (1.3 Mbit/s, average size per frame 11.3 KB). The date and time are 27/06/2015 02:03:16. At the bottom right, there are 'Settings changes:' buttons for 'Apply' and 'Discard'.

On the left side bar, there are many functions can be used. Please refer to the user guide of Milestone XProtect for how to manage them.

*Note: Some of the functions may not be available in current IP camera version.*

## 3.1.3 Set camera properties

Right click **Camera #** → **Properties**.

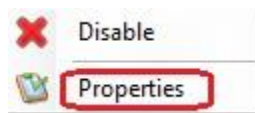

In next window, you can set the properties of the camera.



# M38 IP Camera Module User's Guide

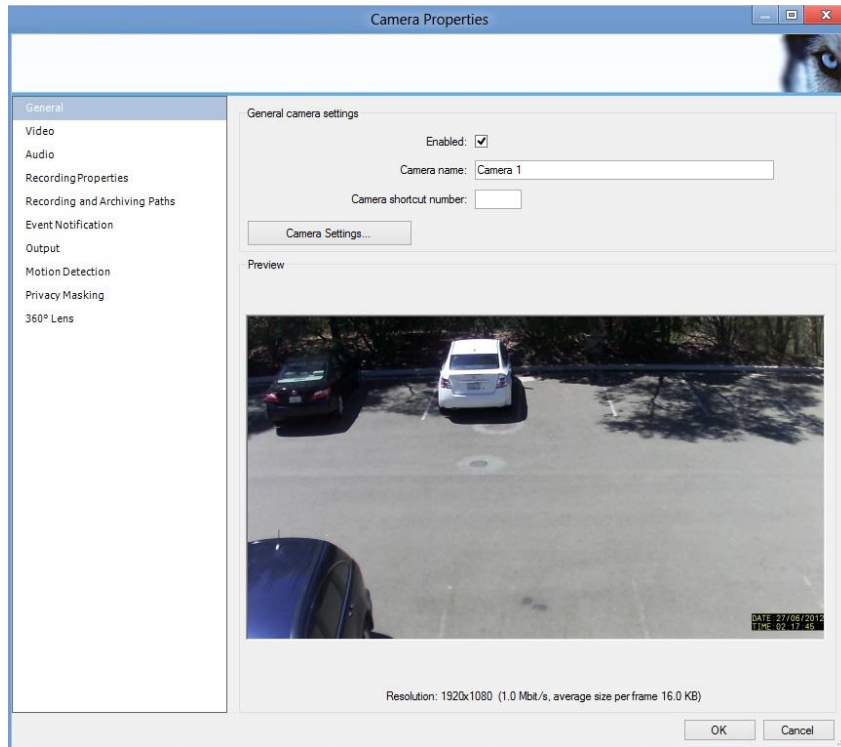

For example, you can set **Motion Detection** and **Privacy Masking**.

- **Set Motion Detection.**

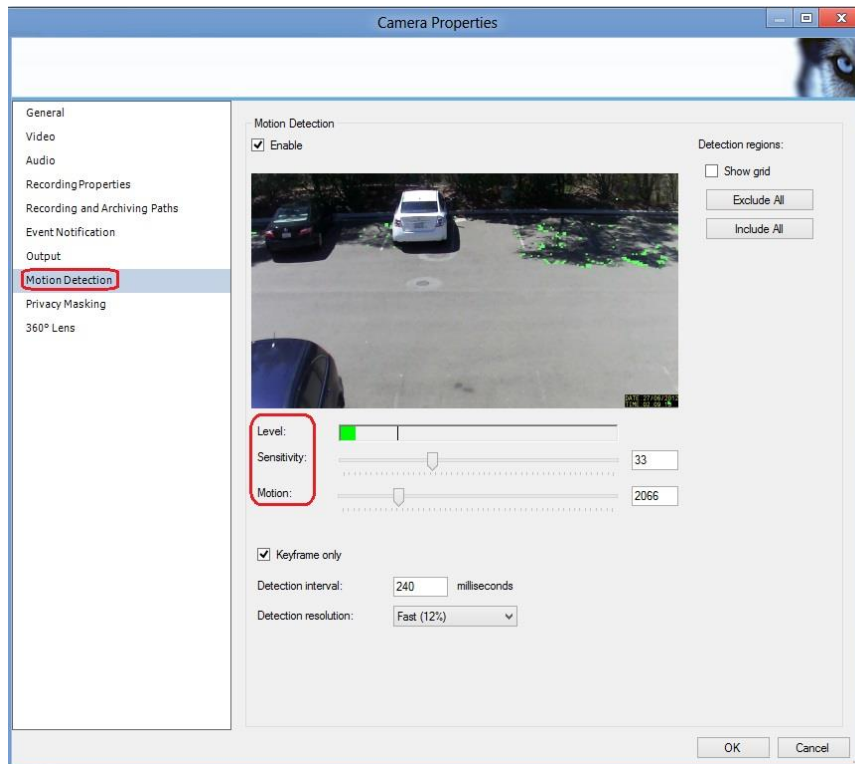

**Sensitivity** and **Motion** can be used to adjust the **level**.  
When the green bar is over the line, the video from the camera will be recorded.





# M38 IP Camera Module User's Guide

You can also check **Show grid** to set the detection regions.

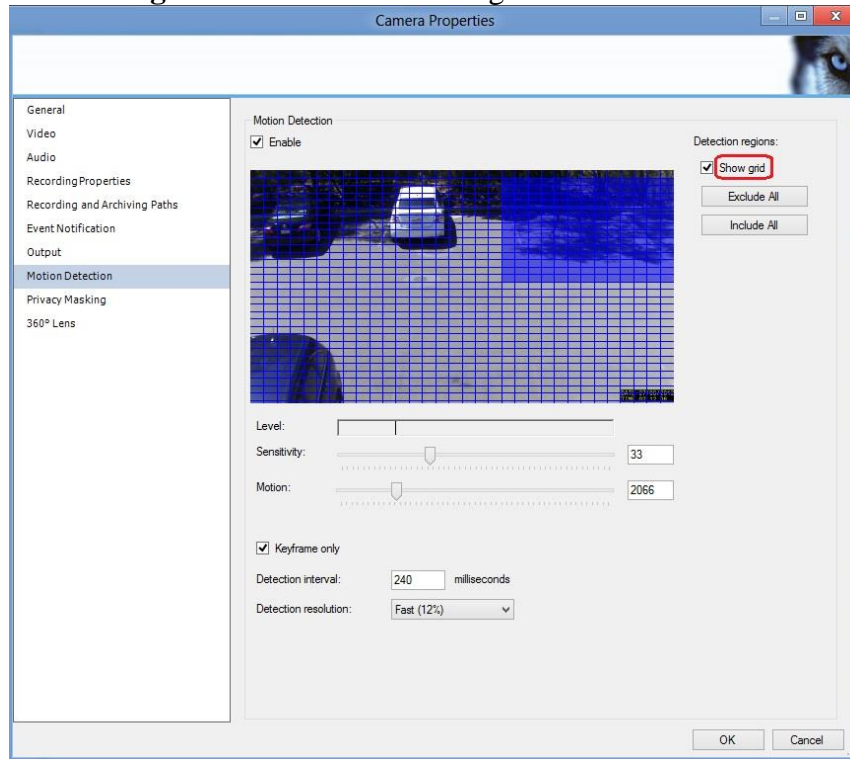

- **Set Privacy Masking.**

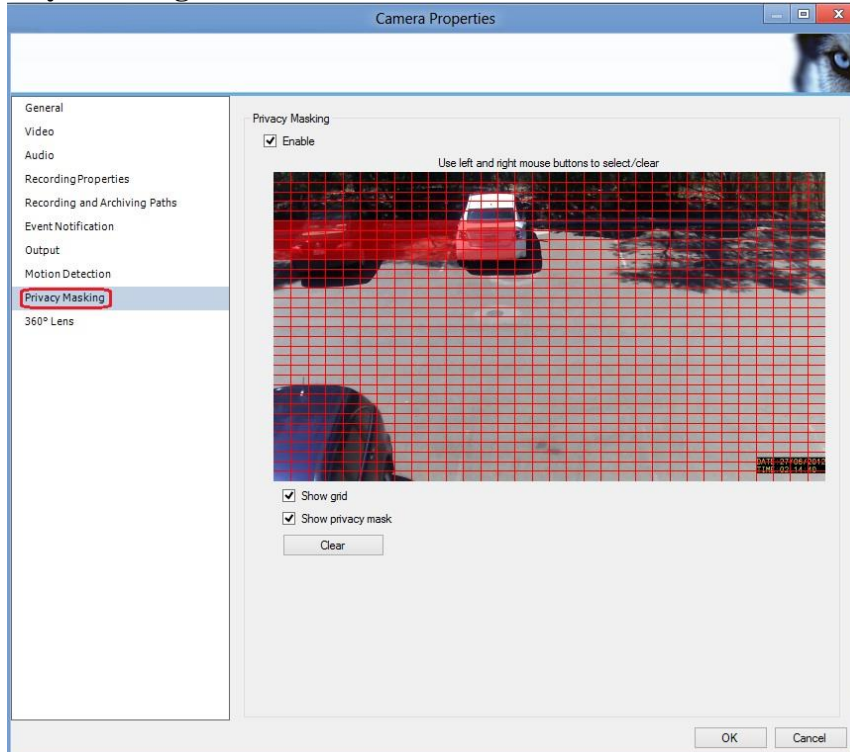

The blocks you select will be a black area in video you get from camera.  
After you set the properties, click **OK** to save it.



## M38 IP Camera Module User's Guide

When you finish the configuration and close Management Application, you will get the following window.

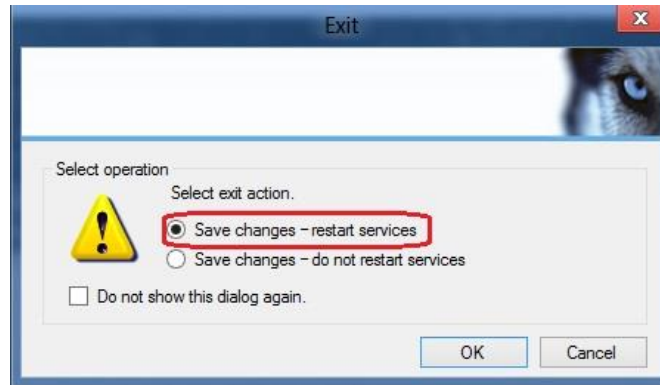

Select **Save changes – restart services**, then click **OK**.

### 3.2 Run Smart Client

Open **Milestone XProtect Smart Client**.

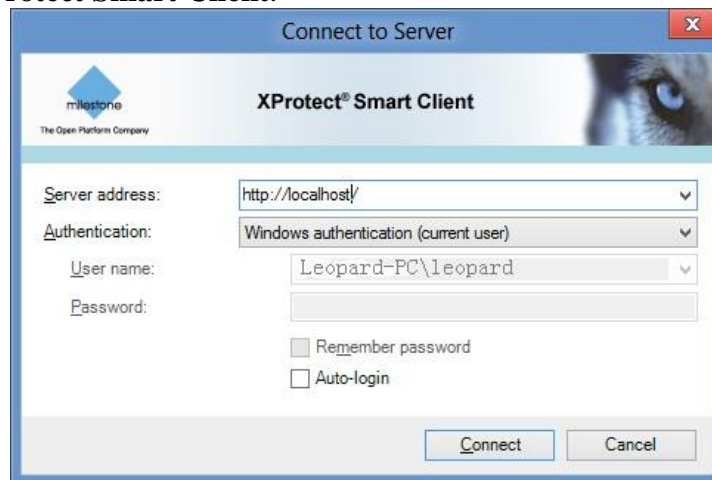

Click **Connect**.

**Note:** If you use the default port 80, the **Server address** is **http://localhost/** ; if you change the port, for example, change to 81, the **Server address** should be **http://localhost:81/**.

#### 3.2.1 Live Video

In next window, go to **Server → Cameras → Camera #**.

Select the required camera from the list, and drag the camera to the required position in the view. You will see the live video from the camera.



# M38 IP Camera Module User's Guide

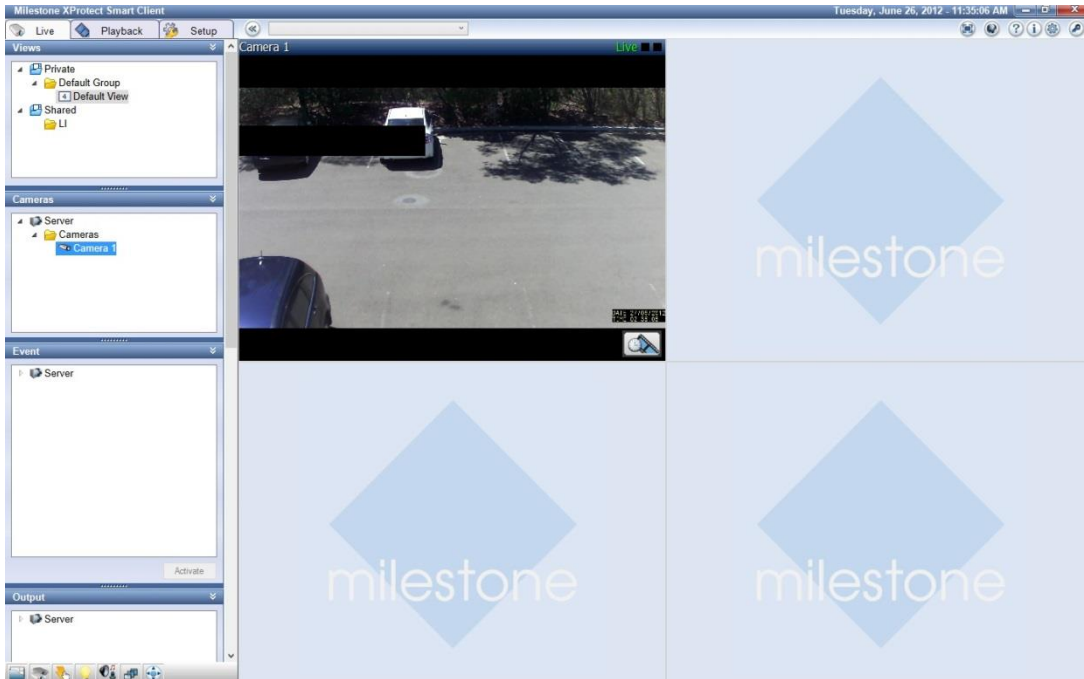

## 3.2.2 Playback

If you want to playback the video, select **Playback** tab.

Right click the view → **Launch Sequence Explorer**, you will get the following window.

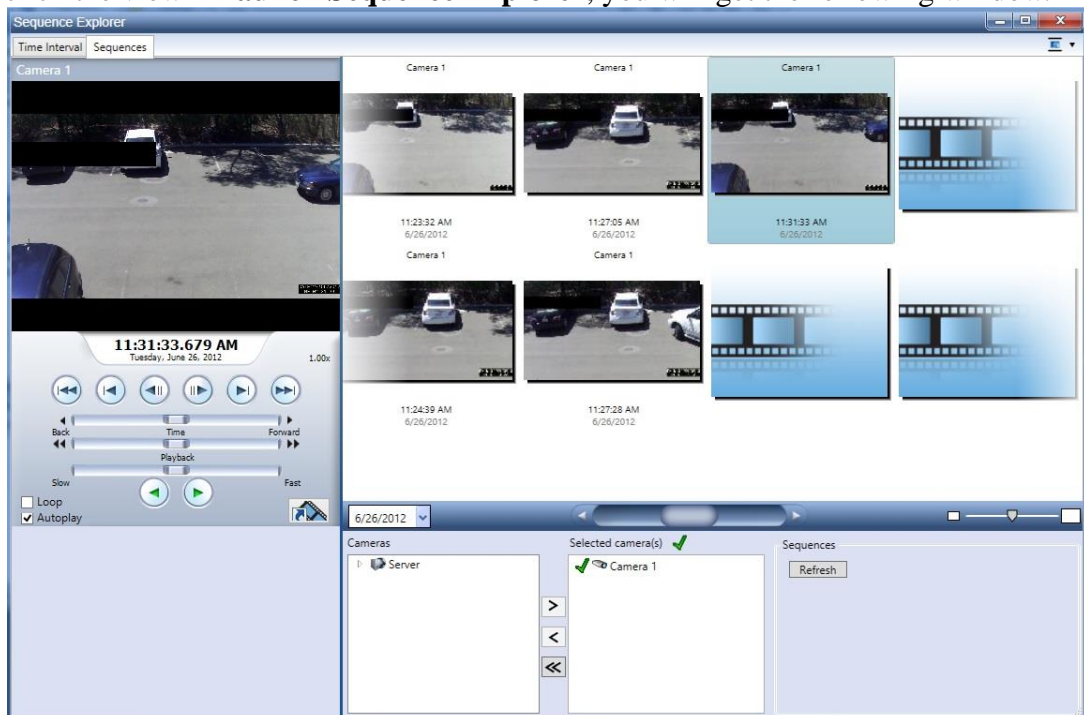

You can select the video which you want to playback.

*Note: If you want to know more about the functions and settings, please refer to the user guide of Milestone XProtect.*



## A3. M38 IP Camera Module Interface

### 1. Common Interface

#### 1.1 Power

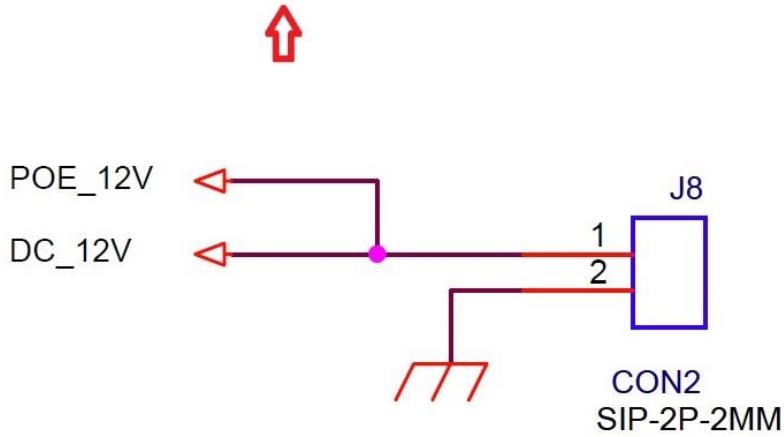
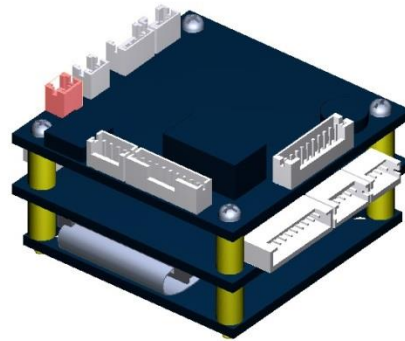
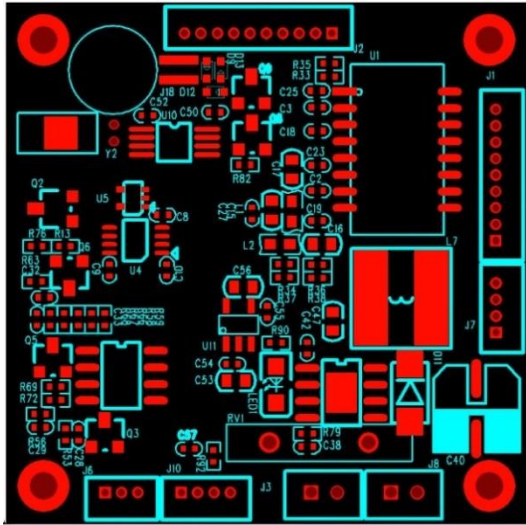

2.0mm distance

DC 12V FROM EXTERNAL ADAPTER OR POE		
PIN #	I/O	Description
1	I	POSITIVE
2	--	GND

## 1.2 Network

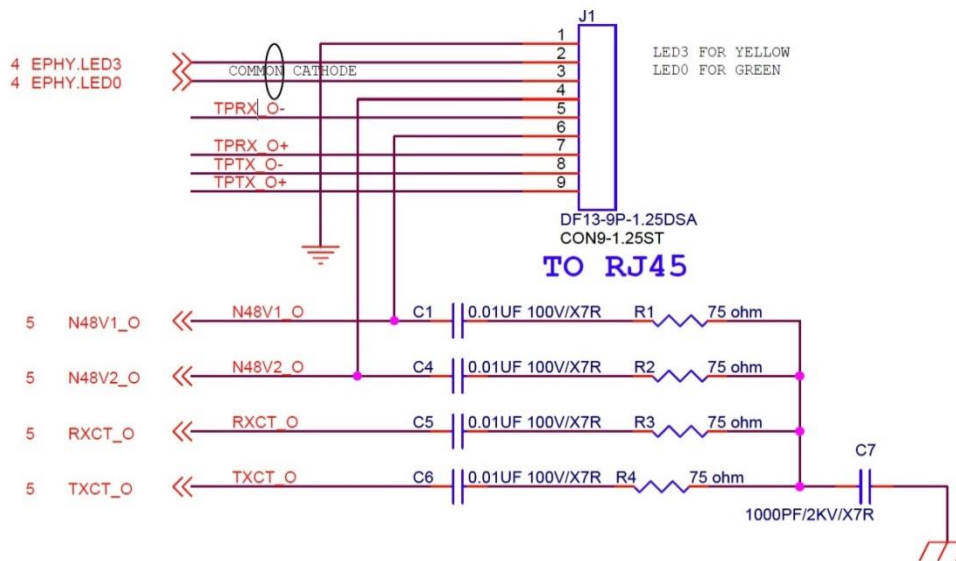
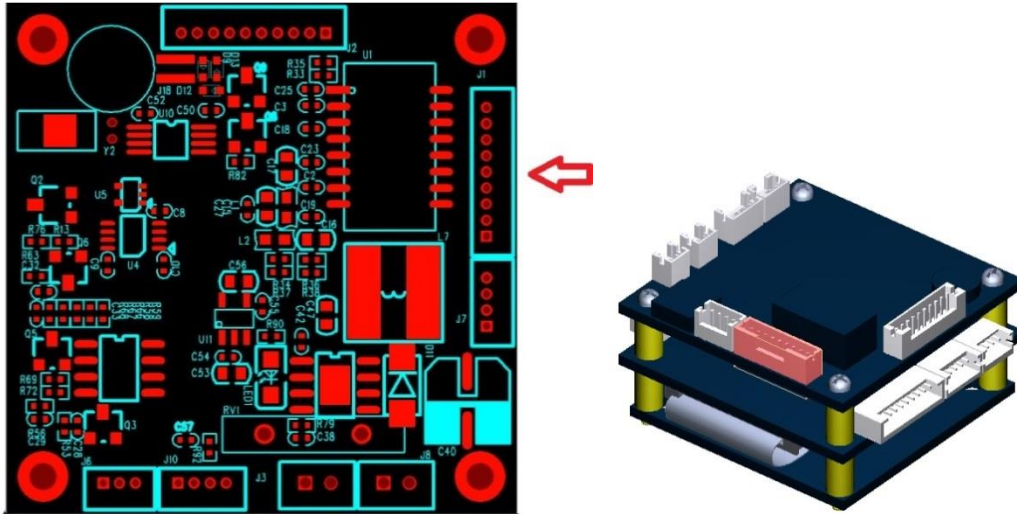

1.25mm distance

Network Interface		
PIN #	I/O	Description
1	--	GND
2	O	POWER FOR YELLOW LED IN RJ45
3	O	POWER FOR GREEN LED IN RJ45
4	--	48V FOR POE
5	I	ETHERNET TRANSMIT DATA NEGATIVE
6	--	48V FOR POE
7	I	ETHERNET RECEIVE DATA POSITIVE
8	O	ETHERNET TRANSMIT DATA NEGATIVE
9	O	ETHERNET TRANSMIT DATA POSITIVE



## 1.3 Audio and Video

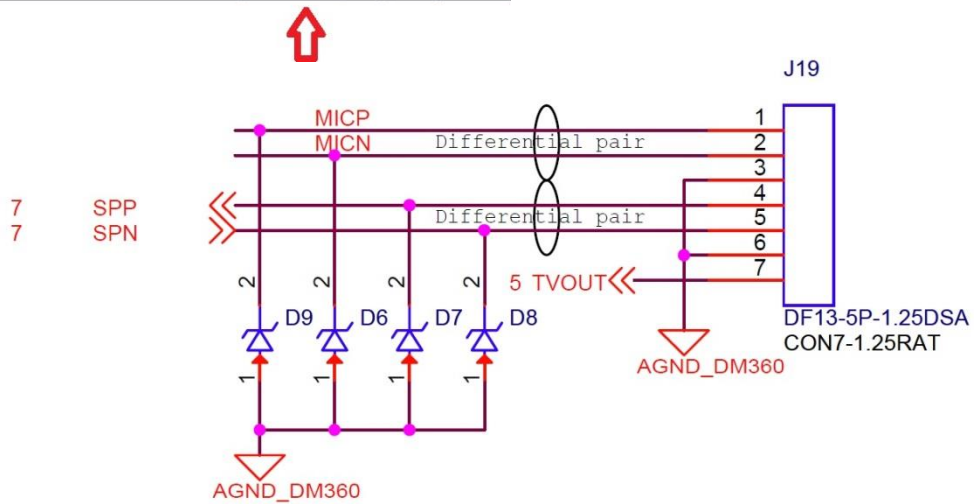
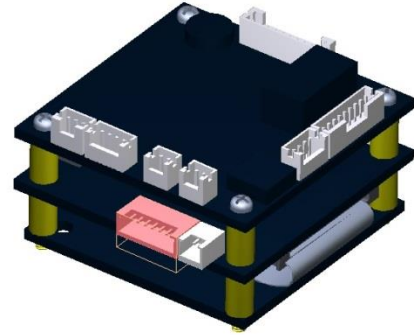
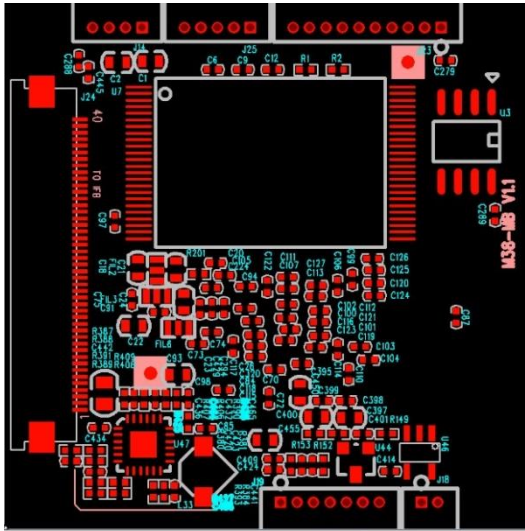

1.25mm distance

Audio and Video Interface		
PIN #	I/O	Description
1	I	MIC+
2	I	MIC-
3	--	GND
4	O	SPEAKER+
5	O	SPEAKER-
6	--	GND
7	O	VIDEO SIGNAL



## 1.4 IR-CUT

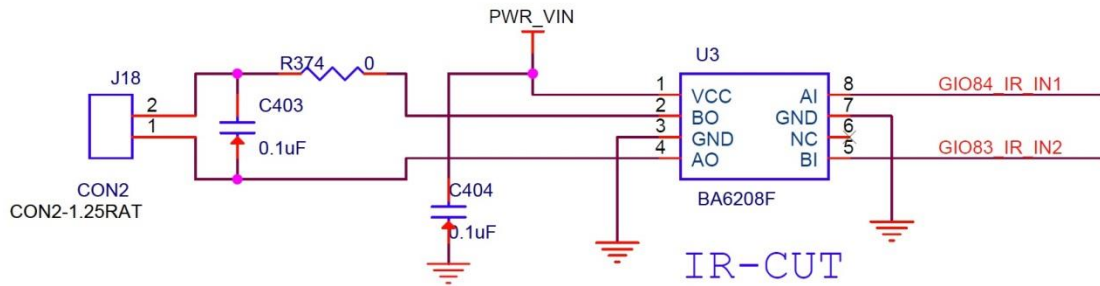
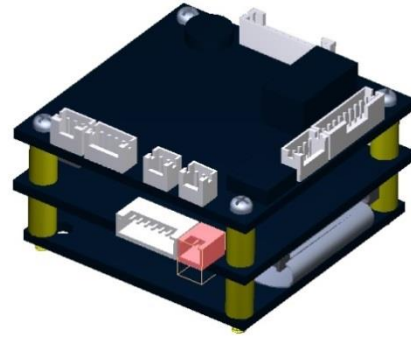
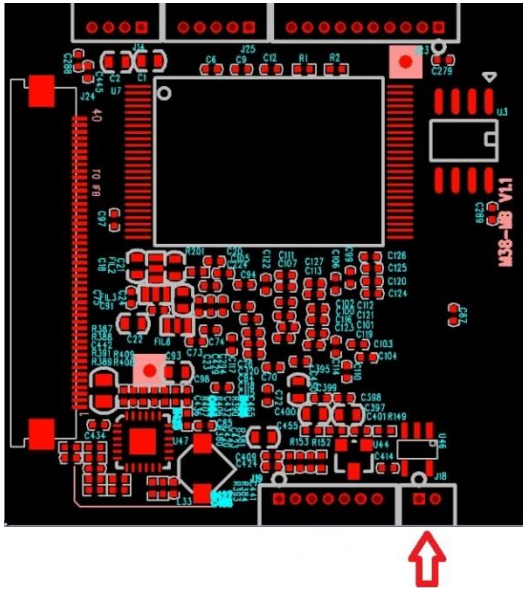

1.25mm distance

IR-CUT Interface		
PIN #	I/O	Description
1	O	IR-CUT+
2	--	IR-CUT-

## 1.5 Power of IR LED

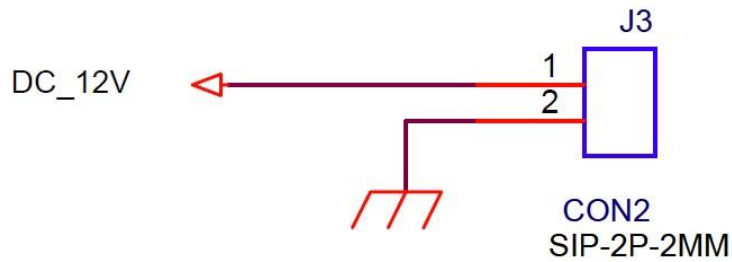
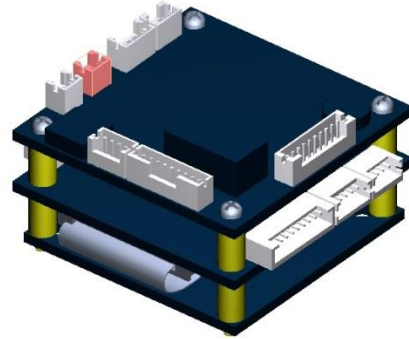
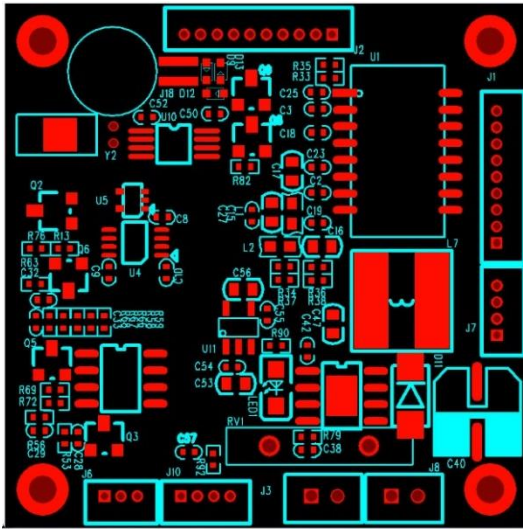

2.0mm distance

TO IR-LED BOARD		
PIN #	I/O	Description
1	I	DC 12V FOR IR LED
2	--	GND



## 1.6 IR LED Control

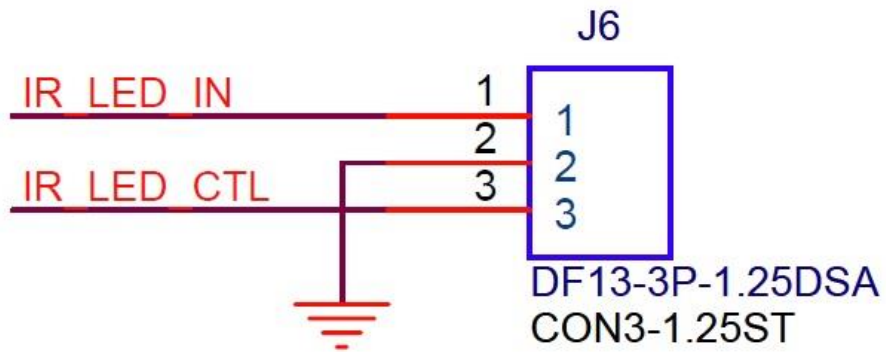
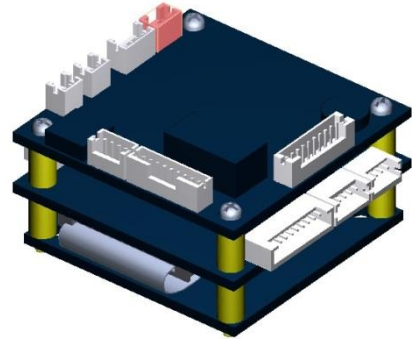
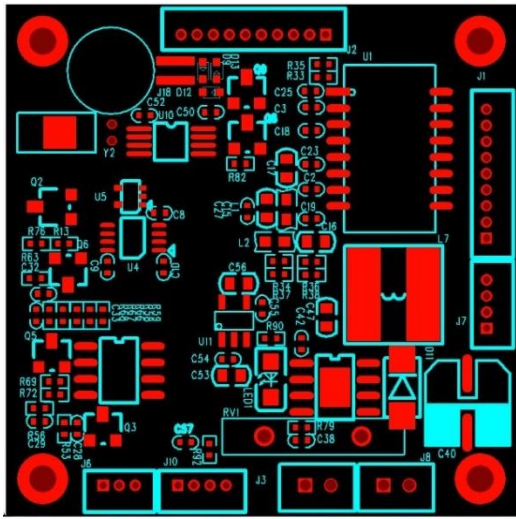

1.25mm distance

TO IR-LED BOARD		
PIN #	I/O	Description
1	I	IR LED SYNC INPUT
2	--	GND
3	O	IR LED CONTROL OUTPUT

## 1.7 IRIS

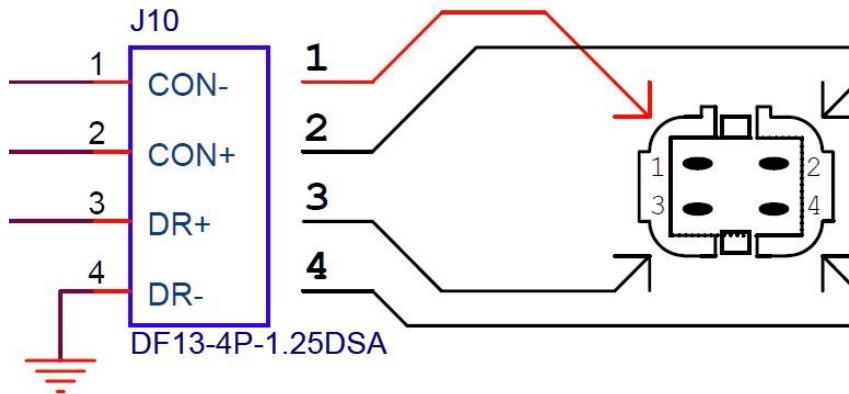
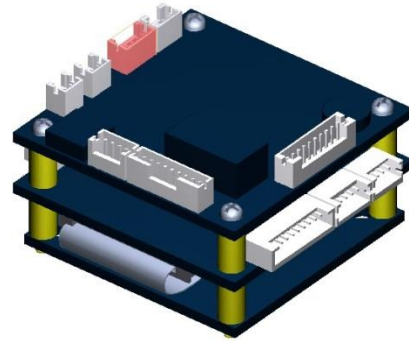
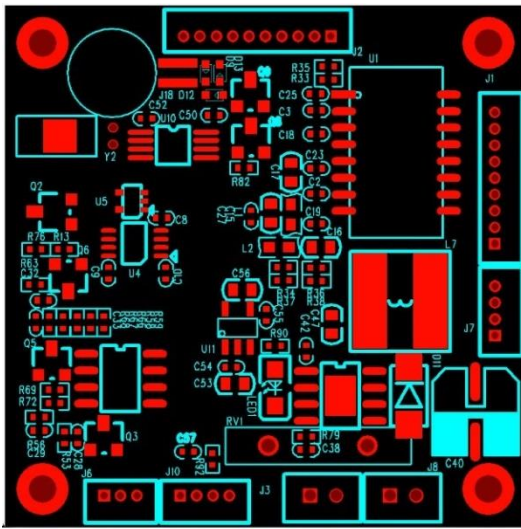

1.25mm distance

IRIS Interface		
PIN #	I/O	Description
1	O	CON-
2	O	CON+
3	O	DR+
4	--	GND

## 1.8 Software Reset, Status LED, Alarm and RS485

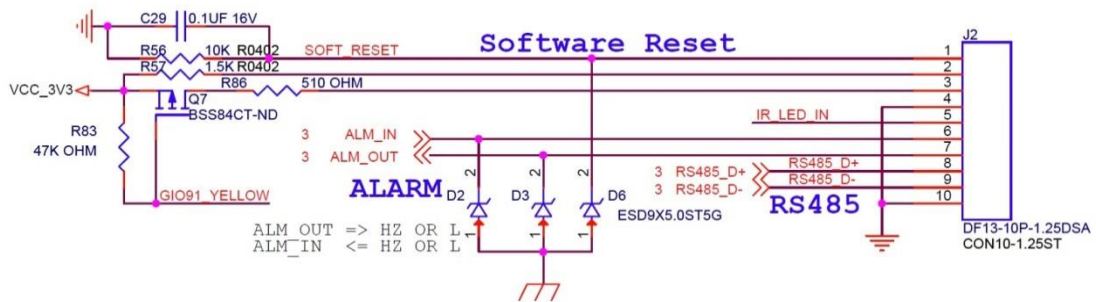
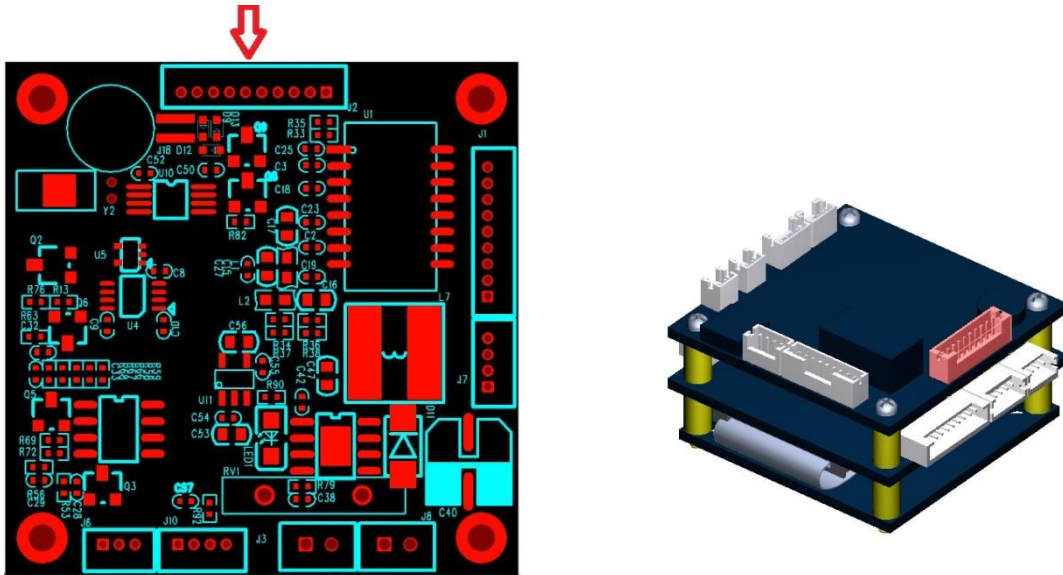

1.25mm distance

Software Reset, Status LED, Alarm and RS485 Interface		
PIN #	I/O	Description
1	I	SOFTWARE RESET
2	O	3V3 FOR SOFTWARE RESET
3	O	LED+
4	I	LED-
5	I	IR LED SYNC INPUT
6	I	ALARM INPUT
7	O	ALARM OUTPUT
8	I/O	485+
9	I/O	485-
10	--	GND



## 2. Extended Interface

### 2.1 WIFI

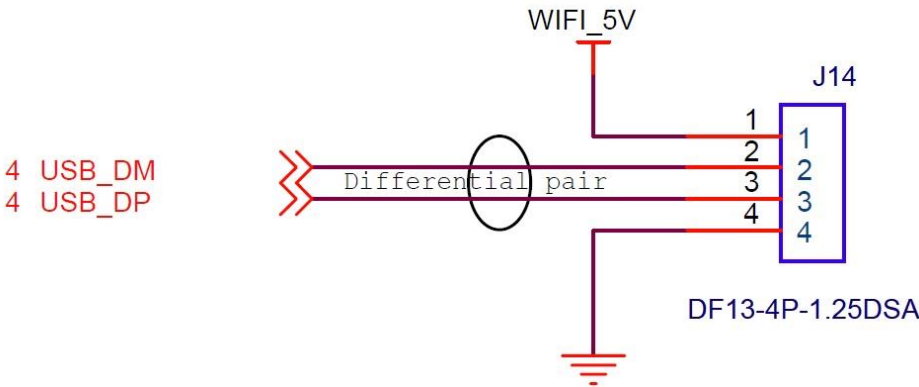
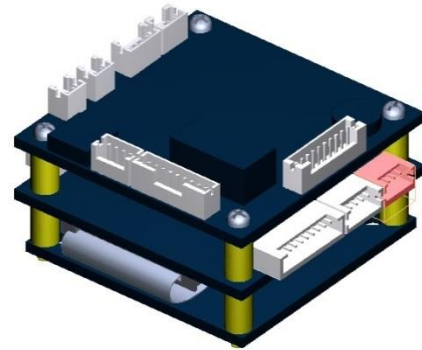
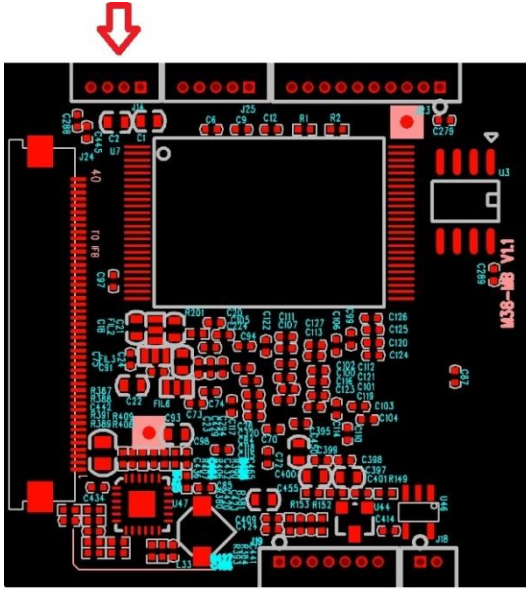

1.25mm distance

WIFI Interface		
PIN #	I/O	Description
1	--	5V
2	I/O	USB DATA POSITIVE I/O
3	I/O	USB DATA NEGATIVE I/O
4	--	GND



## 2.2 SD card

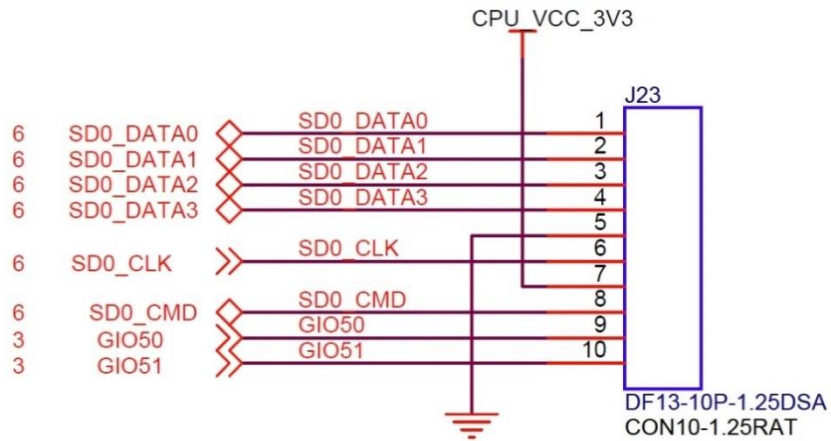
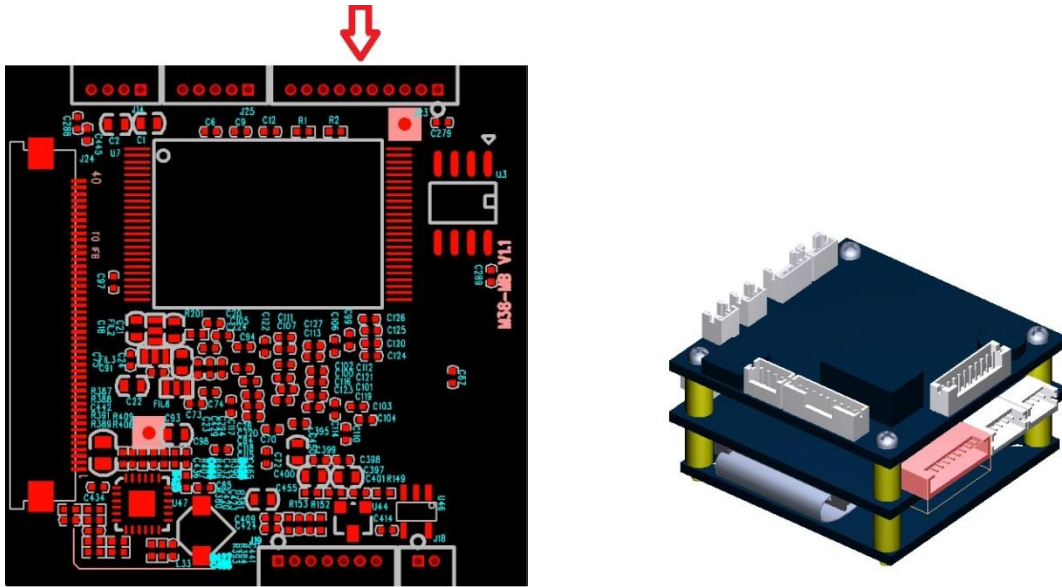

1.25mm distance

SD Card Interface		
PIN #	I/O	Description
1	I/O	SD CARD DATA 0
2	I/O	SD CARD DATA 1
3	I/O	SD CARD DATA 2
4	I/O	SD CARD DATA 3
5	--	GND
6	O	SD CARD CLOCK OUTPUT
7	O	3V3 FOR SD CARD
8	I/O	SD CARD COMMAND
9	I	SD CARD DETECT
10	O	SD CARD WRITE PROTECT



## 2.3 PoE

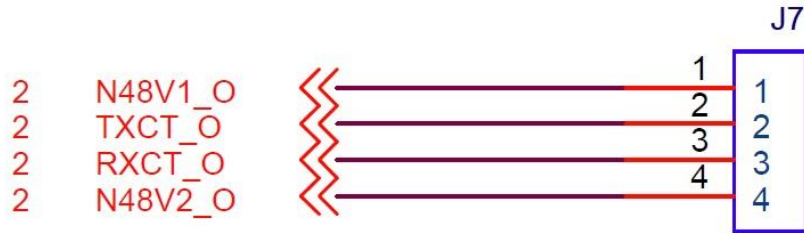
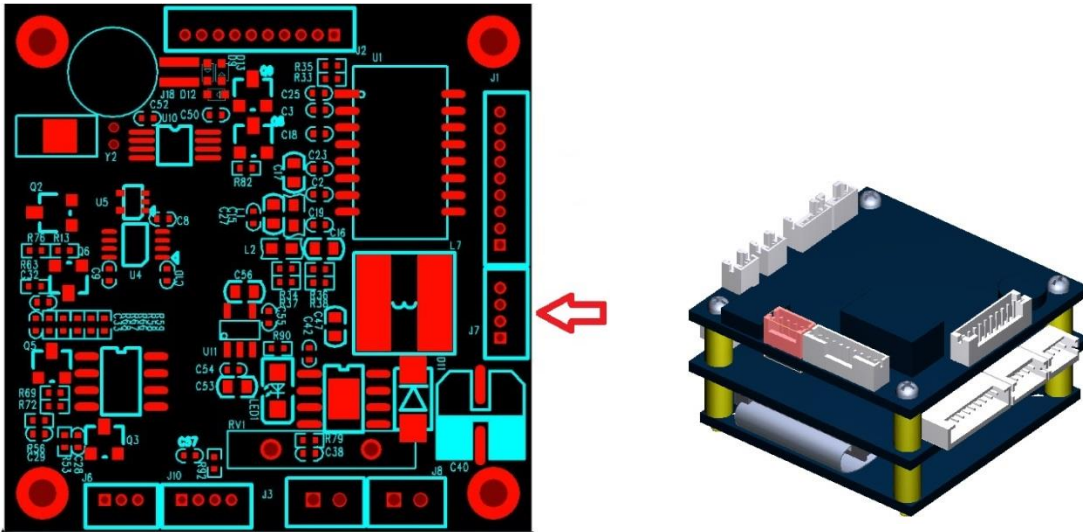

DF13-4P-1.25DSA

## TO POE BOARD

1.25mm distance

TO POE BOARD		
PIN #	I/O	Description
1	O	ETHERNET 48V FROM RJ45
2	O	ETHERNET 48V FROM TRANSFORMER
3	O	ETHERNET 48V FROM TRANSFORMER
4	O	ETHERNET 48V FROM RJ45



## 2.4 Debug

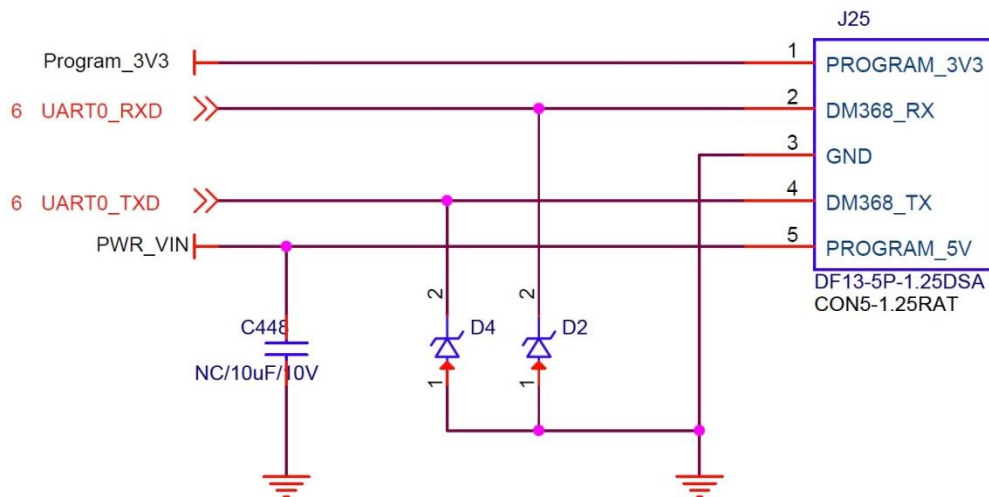
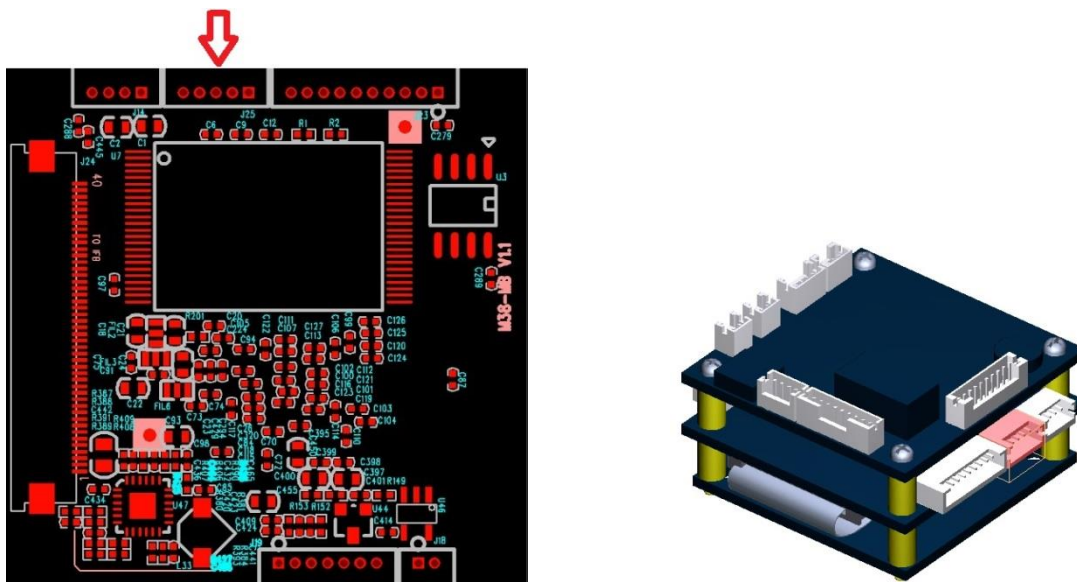

1.25mm distance

DEBUG Interface		
PIN #	I/O	Description
1	O	3V3 FOR PROGRAM
2	I	UART0 RECEIVE
3	--	GND
4	O	UART0 TRANSMIT
5	--	5V



## 3. Back Interface



Interface	Description
LAN	RJ45 LAN CONNECTOR
POWER	POWER INPUT DC 12V/1A
AUDIO OUT	AUDIO OUTPUT
AUDIO IN	AUDIO INPUT
RESET	RESET BUTTON
ANT	WIRELESS LAN INTERFACE
VIDEO	VIDEO OUTPUT

Terminal Block		
PIN #	I/O	Description
1	O	485+
2	O	485-
3	I	ALARM INPUT
4	O	ALARM OUTPUT
5	I	IR LED SYNC INPUT
6	N	GND



## A4. Install Add-on to get the IE Interface

Open IE, Go to **Internet Options** → **Security** → **Trusted sites**.

Click **Sites**, uncheck **Require server verification (https:)** for all sites in this zone and add the IP address of camera to **Websites**.

For example: `http://192.168.0.*`

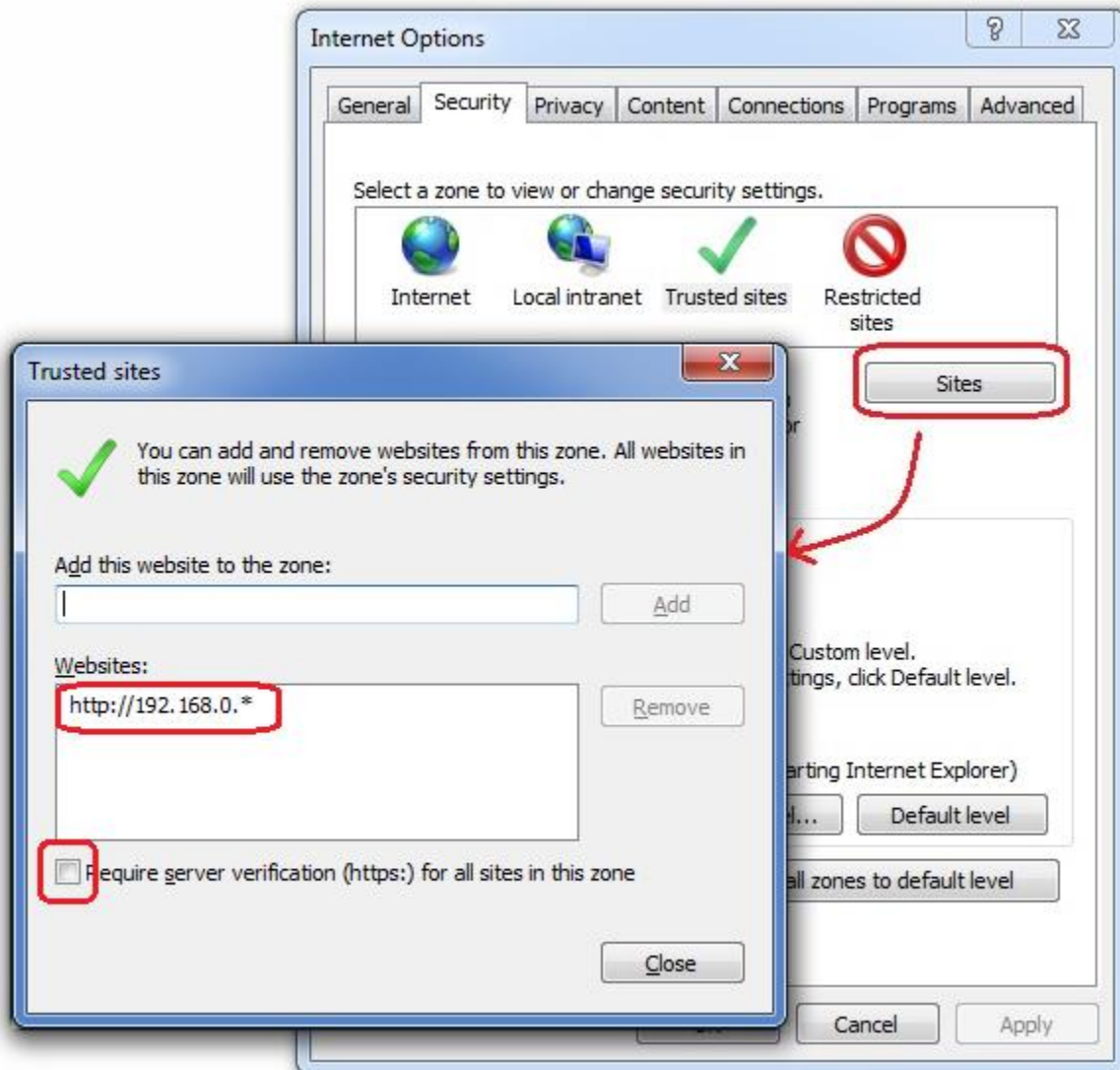

Click **Custom level**, enable **Download unsigned ActiveX controls** and **Initialize and script ActiveX controls not marked as safe for scripting**.

# M38 IP Camera Module User's Guide

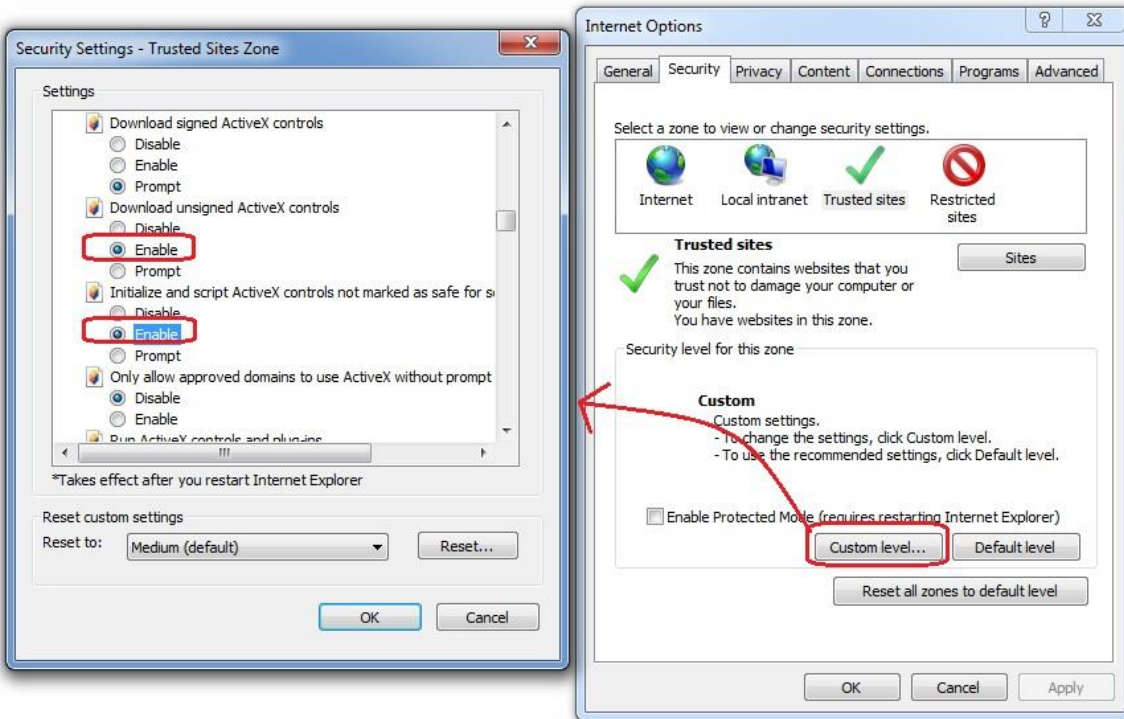

On IE interface (after login), reload the page.



If you get a message above, click **Install**.

After install the ActiveX control, you will see the live video.

## A5. How to use WIFI

If there is an optional WIFI module on your camera board, you can run this camera with WIFI.

1. Please check the Product Model in “[About Product](#)”.

If the Model# is **LI-M38-xxx-W**, the WIFI function can be used directly via WIFI module.

If the Model# is **LI-M38-xxx-P**, please refer to section 4.4 (Page 6) of the Reprogram guide (Reprogram\_M38\_Module.pdf) to set the mode to WIFI.

Command: **setenv pro\_extent W**

2. Plug the WIFI module to J14 of M38 camera module.

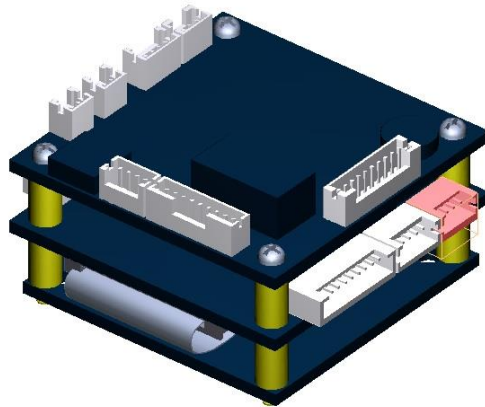

3. For the first time you use the WIFI function, you need to enter IE interface with network cable and go to **Network Setting** → **WIFI Access** to enable the WIFI. Then select the WIFI ID and enter password.

### WIFI Access Setting

Enable WIFI       On     Off

SSID                      SNet   

Password                      12345

After click **Save**, the camera will reboot.



## M38 IP Camera Module User's Guide

4. After the camera boots up, you can get the IP address from the serial log screen ( the WIFI IP address is behind the IP address from network cable) or the UPnP device.

Note: 1. Please make sure the camera module and your PC (which access the camera via WIFI) are in the same network (wifi router).

2. You can also set the static IP of WIFI.

Go to **WIFI Settings**.

### WIFI Setting

Enable DHCP  On  Off

IP Address

Netmask

Gateway

DNS Server

Select **Static IP**, enter the static IP address, and click **submit**.

The IP camera will reboot in next step. After the camera boots up, the static IP address can be used to open the IE interface.



## A6. Streaming video via RTSP on VLC

Open VLC media player. Got to **Media** → **Open Network Stream**.

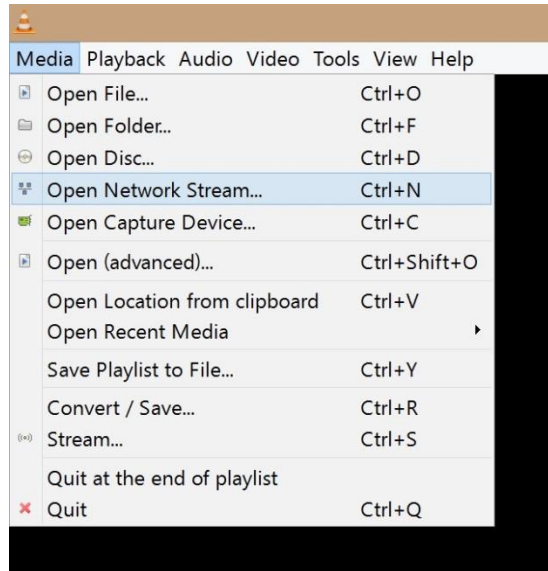

In Next window, enter the URL [rtsp://<IP\\_address>:554/0](rtsp://<IP_address>:554/0) for main stream or [rtsp://<IP\\_address>:554/1](rtsp://<IP_address>:554/1) for sub stream, then click **Play**, you will get the video.

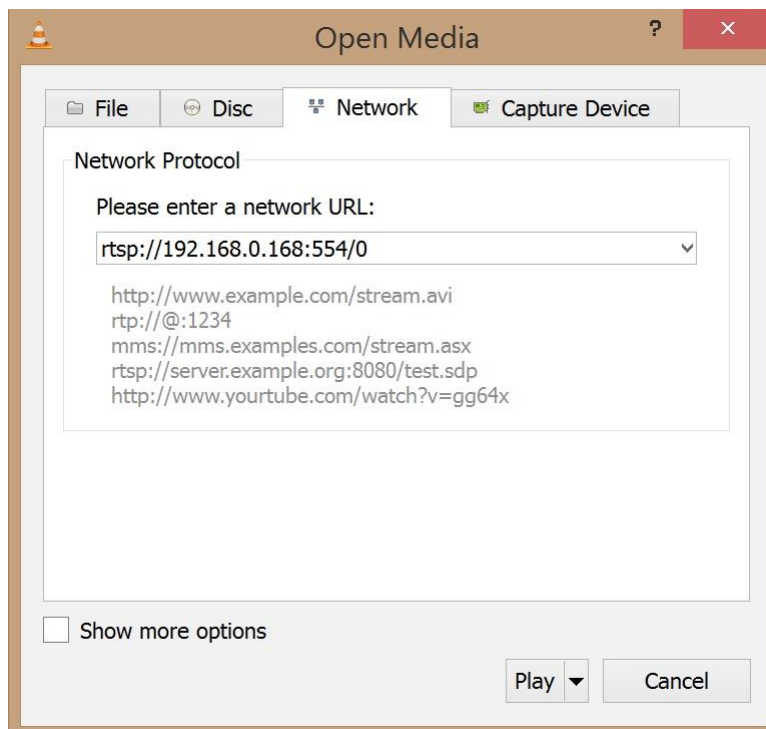

### Glossary

- ❖ **Alert:** An alert can be in the form of an e-mail or an ftp upload of an image, that occurs when a sensor is triggered, or motion is detected.
- ❖ **AVI:** Audio Video Interleaved. A Windows multimedia video format from Microsoft.
- ❖ **CIF:** Common Interface Format. A standard video resolution format used in video conferencing. CIF resolution is 352x288 and bit rate is 36.5 Mbps (at 30fps)
- ❖ **DHCP:** Dynamic Host Configuration Protocol. A system by which each piece of equipment on a network is allocated an address IP dynamically.
- ❖ **Ethernet:** The most widely used local area network (LAN) access method, defined by the IEEE as the 802.3 standard.
- ❖ **FTP:** File Transfer Protocol. A standard protocol designed for transferring files over a TCP/IP net-work.
- ❖ **IP:** Internet Protocol. The network layer protocol in the TCP/IP communications protocol suite (the “IP” in TCP/IP). IP contains a network address and allows messages to be routed to a different network or subnet.
- ❖ **LED:** Light Emitting Diode. A semiconductor device that emits light when a voltage is applied.
- ❖ **Motion detection:** Camera function that causes an alert to be triggered when movement is detected in the field of view.
- ❖ **Protocol:** Standards governing the transmission and reception of data.
- ❖ **Resolution:** Screen resolution is expressed as a matrix of dots. For example, the VGA resolution of 640x480 means 640 dots (pixels) across each of the 480 lines.
- ❖ **RJ-45:** Registered Jack 45. RJ-45 type connections are used in Ethernet devices.



- ❖ **SNTP:** Simple Network Time Protocol. A protocol that allows devices to update internal clocks using a standard source available on a network.
- ❖ **Static IP address:** A static IP address that is assigned manually and never changes.
- ❖ **TCP/IP:** Transmission Control Protocol/Internet Protocol. A communications protocol developed under contract from the U.S.
- ❖ **VGA:** Video Graphic Array. The video display standard for the PC.

