

# DATA SHEET

## **MAC223 series** **Triacs**

Product specification

July 2001

**Triacs**

**MAC223 series**

**GENERAL DESCRIPTION**

Passivated triacs in a plastic envelope, intended for use in applications requiring high bidirectional transient and blocking voltage capability and high thermal cycling performance. Typical applications include motor control, industrial and domestic lighting, heating and static switching.

**QUICK REFERENCE DATA**

| SYMBOL       | PARAMETER                            | MAX. |     | UNIT |
|--------------|--------------------------------------|------|-----|------|
|              |                                      | A6   | A8  |      |
| $V_{DRM}$    | Repetitive peak off-state voltages   | 400  | 600 | V    |
| $I_{T(RMS)}$ | RMS on-state current                 | 25   | 25  | A    |
| $I_{TSM}$    | Non-repetitive peak on-state current | 230  | 230 | A    |

**PINNING - TO220AB**

| PIN | DESCRIPTION     |
|-----|-----------------|
| 1   | main terminal 1 |
| 2   | main terminal 2 |
| 3   | gate            |
| tab | main terminal 2 |

**PIN CONFIGURATION**

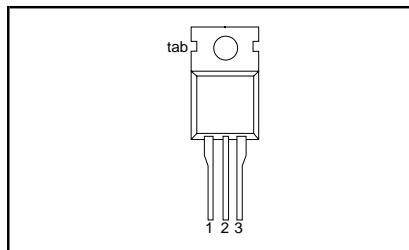

**SYMBOL**

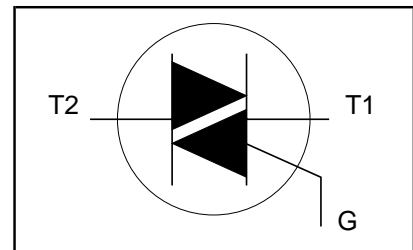

**LIMITING VALUES**

Limiting values in accordance with the Absolute Maximum System (IEC 134).

| SYMBOL       | PARAMETER  | CONDITIONS  | MIN. | MAX.             |                  | UNIT             |
|--------------|--|---|------|------------------|------------------|------------------|
|              |  |   |      | A6               | A8               |                  |
| $V_{DRM}$    | Repetitive peak off-state voltages                           | MAC223  | -    | 400 <sup>1</sup> | 600 <sup>1</sup> | V                |
| $I_{T(RMS)}$ | RMS on-state current   | full sine wave; $T_{mb} \leq 91\text{ }^\circ\text{C}$                                  | -    | 25               |                  | A                |
| $I_{TSM}$    | Non-repetitive peak on-state current                         | full sine wave; $T_j = 25\text{ }^\circ\text{C}$ prior to surge                         | -    | 190              |                  | A                |
|              |  | $t = 20\text{ ms}$  | -    | 230              |                  | A                |
|              |  | $t = 16.7\text{ ms}$  | -    | 230              |                  | A                |
|              |  | $t = 10\text{ ms}$  | -    | 180              |                  | A <sup>2</sup> s |
| $I^2t$       | $I^2t$ for fusing  |   |      |                  |                  |                  |
| $di_T/dt$    | Repetitive rate of rise of on-state current after triggering | $I_{TM} = 30\text{ A}$ ; $I_G = 0.2\text{ A}$ ;<br>$di_G/dt = 0.2\text{ A}/\mu\text{s}$ |      |                  |                  |                  |
|              |  | T2+ G+  | -    | 50               |                  | A/ $\mu\text{s}$ |
|              |  | T2+ G-  | -    | 50               |                  | A/ $\mu\text{s}$ |
|              |  | T2- G-  | -    | 50               |                  | A/ $\mu\text{s}$ |
|              |  | T2- G+  | -    | 10               |                  | A/ $\mu\text{s}$ |
| $I_{GM}$     | Peak gate current  |   | -    | 2                |                  | A                |
| $V_{GM}$     | Peak gate voltage  |   | -    | 5                |                  | V                |
| $P_{GM}$     | Peak gate power  |   | -    | 5                |                  | W                |
| $P_{G(AV)}$  | Average gate power   | over any 20 ms period   | -    | 0.5              |                  | W                |
| $T_{stg}$    | Storage temperature  |   | -40  | 150              |                  | $^\circ\text{C}$ |
| $T_j$        | Operating junction temperature                               |   | -    | 125              |                  | $^\circ\text{C}$ |

<sup>1</sup> Although not recommended, off-state voltages up to 800V may be applied without damage, but the triac may switch to the on-state. The rate of rise of current should not exceed 15 A/ $\mu\text{s}$ .

## Triacs

## MAC223 series

**THERMAL RESISTANCES**

| SYMBOL         | PARAMETER                                    | CONDITIONS  | MIN. | TYP. | MAX. | UNIT |
|----------------|--|-------------|------|------|------|------|
| $R_{th\ j-mb}$ | Thermal resistance junction to mounting base | full cycle  | -    | -    | 1.0  | K/W  |
|                |  | half cycle  | -    | -    | 1.4  | K/W  |
| $R_{th\ j-a}$  | Thermal resistance junction to ambient       | in free air | -    | 60   | -    | K/W  |

**STATIC CHARACTERISTICS** $T_j = 25\text{ °C}$  unless otherwise stated

| SYMBOL   | PARAMETER                 | CONDITIONS  | MIN. | TYP. | MAX. | UNIT |
|----------|---------------------------|---|------|------|------|------|
| $I_{GT}$ | Gate trigger current      | $V_D = 12\text{ V}; I_T = 0.1\text{ A}$                       |      |      |      |      |
|          |                           | T2+ G+  | -    | 6    | 50   | mA   |
|          |                           | T2+ G-  | -    | 10   | 50   | mA   |
|          |                           | T2- G-  | -    | 11   | 50   | mA   |
|          |                           | T2- G+  | -    | 23   | 75   | mA   |
| $I_L$    | Latching current          | $V_D = 12\text{ V}; I_{GT} = 0.1\text{ A}$                    |      |      |      |      |
|          |                           | T2+ G+  | -    | 8    | 40   | mA   |
|          |                           | T2+ G-  | -    | 30   | 60   | mA   |
|          |                           | T2- G-  | -    | 18   | 40   | mA   |
|          |                           | T2- G+  | -    | 15   | 60   | mA   |
| $I_H$    | Holding current           | $V_D = 12\text{ V}; I_{GT} = 0.1\text{ A}$                    |      |      |      |      |
|          |                           | T2+   | -    | 7    | 30   | mA   |
|          |                           | T2-   | -    | 12   | 30   | mA   |
| $V_T$    | On-state voltage          | $I_T = 30\text{ A}$   | -    | 1.3  | 1.55 | V    |
| $V_{GT}$ | Gate trigger voltage      | $V_D = 12\text{ V}; I_T = 0.1\text{ A}$                       | -    | 0.7  | 1.5  | V    |
|          |                           | $V_D = 400\text{ V}; I_T = 0.1\text{ A}; T_j = 125\text{ °C}$ | 0.25 | 0.4  | -    | V    |
| $I_D$    | Off-state leakage current | $V_D = V_{DRM(max)}; T_j = 125\text{ °C}$                     | -    | 0.1  | 0.5  | mA   |

**DYNAMIC CHARACTERISTICS** $T_j = 25\text{ °C}$  unless otherwise stated

| SYMBOL        | PARAMETER                                      | CONDITIONS   | MIN. | TYP. | MAX. | UNIT       |
|---------------|--|--|------|------|------|------------|
| $dV_D/dt$     | Critical rate of rise of off-state voltage     | $V_{DM} = 67\% V_{DRM(max)}; T_j = 125\text{ °C};$<br>exponential waveform; gate open circuit                              | 100  | 300  | -    | V/ $\mu$ s |
| $dV_{com}/dt$ | Critical rate of change of commutating voltage | $V_{DM} = 400\text{ V}; T_j = 95\text{ °C}; I_{T(RMS)} = 25\text{ A};$<br>$dI_{com}/dt = 9\text{ A/ms};$ gate open circuit | -    | 10   | -    | V/ $\mu$ s |
| $t_{gt}$      | Gate controlled turn-on time                   | $I_{TM} = 30\text{ A}; V_D = V_{DRM(max)}; I_G = 0.1\text{ A};$<br>$dI_G/dt = 5\text{ A}/\mu$ s                            | -    | 2    | -    | $\mu$ s    |

Triacs

MAC223 series

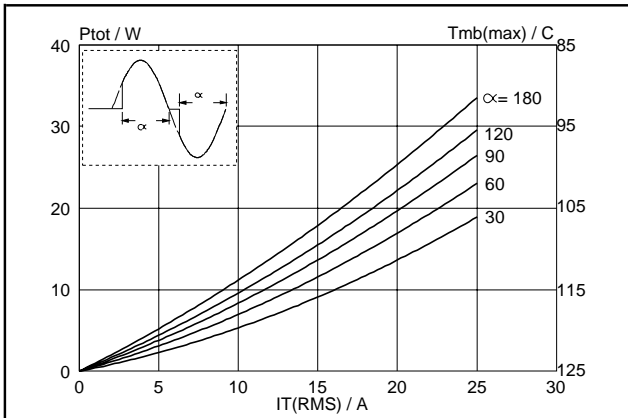

Fig.1. Maximum on-state dissipation,  $P_{tot}$ , versus rms on-state current,  $I_{T(RMS)}$ , where  $\alpha$  = conduction angle.

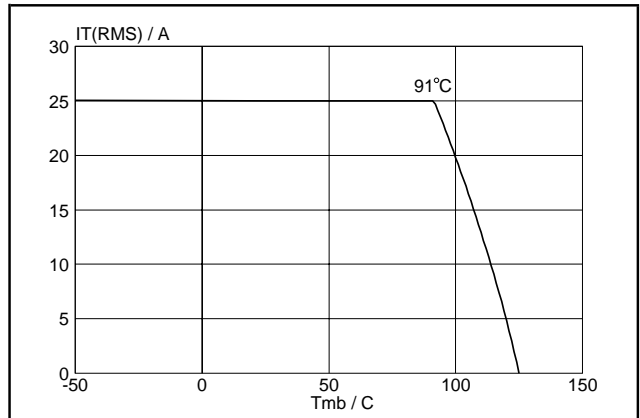

Fig.4. Maximum permissible rms current  $I_{T(RMS)}$ , versus mounting base temperature  $T_{mb}$ .

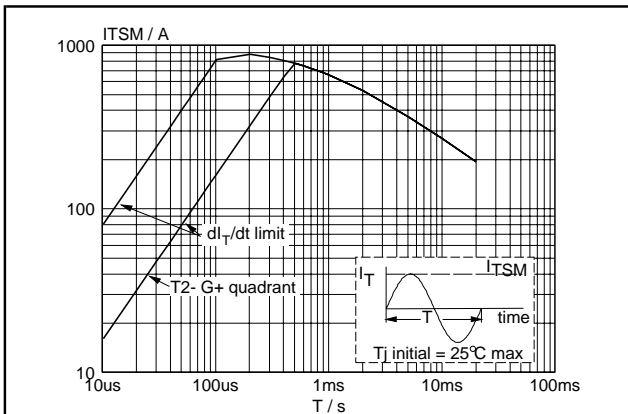

Fig.2. Maximum permissible non-repetitive peak on-state current  $I_{TSM}$ , versus pulse width  $t_p$ , for sinusoidal currents,  $t_p \leq 20ms$ .

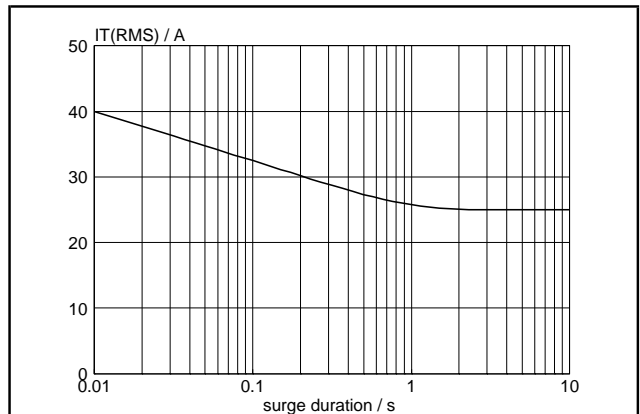

Fig.5. Maximum permissible repetitive rms on-state current  $I_{T(RMS)}$ , versus surge duration, for sinusoidal currents,  $f = 50 Hz$ ;  $T_{mb} \leq 91^\circ C$ .

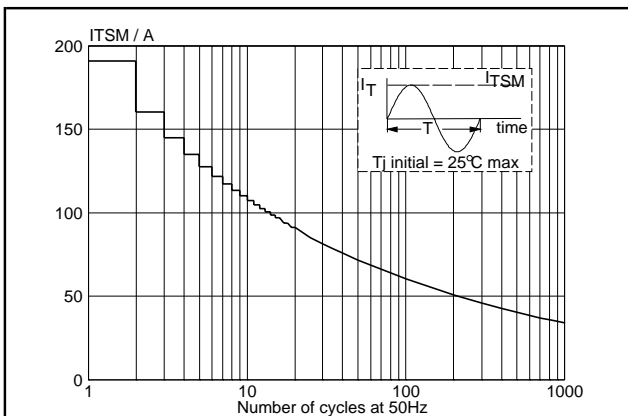

Fig.3. Maximum permissible non-repetitive peak on-state current  $I_{TSM}$ , versus number of cycles, for sinusoidal currents,  $f = 50 Hz$ .

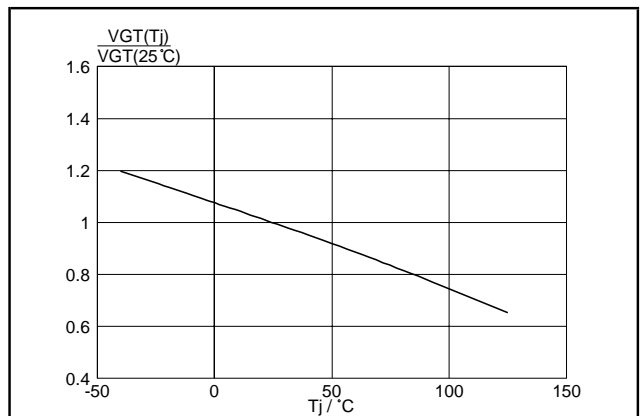
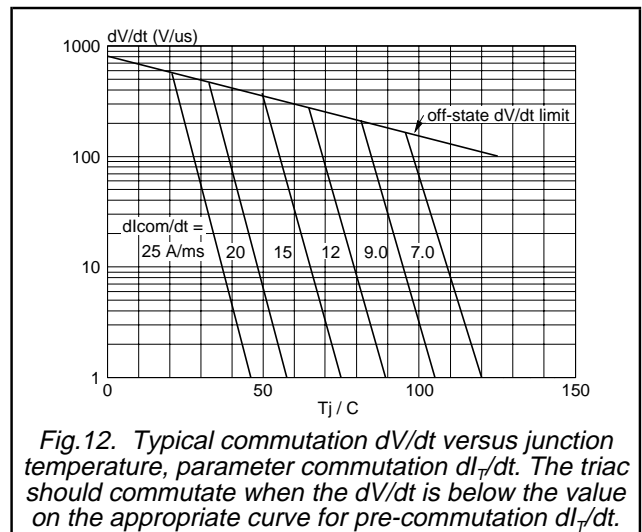
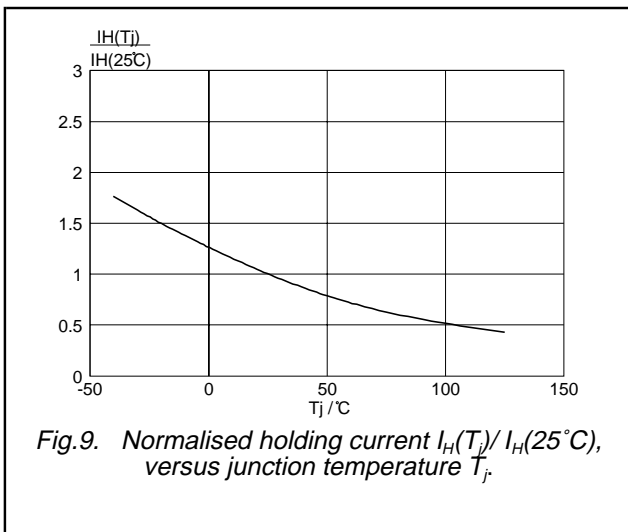
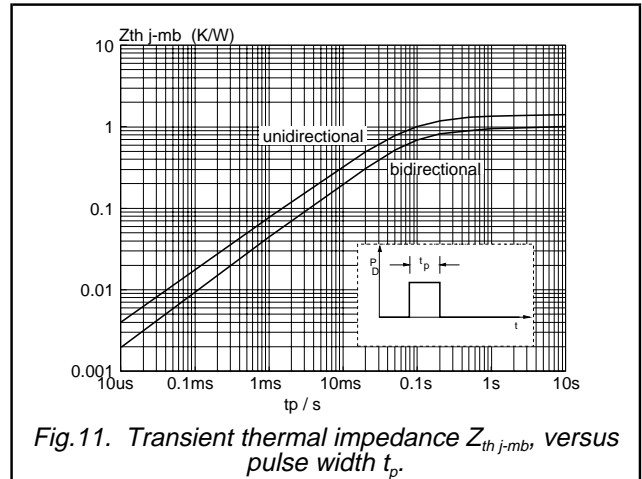
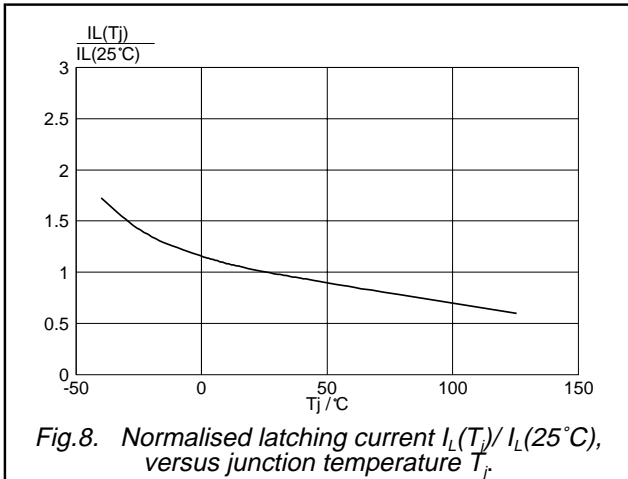
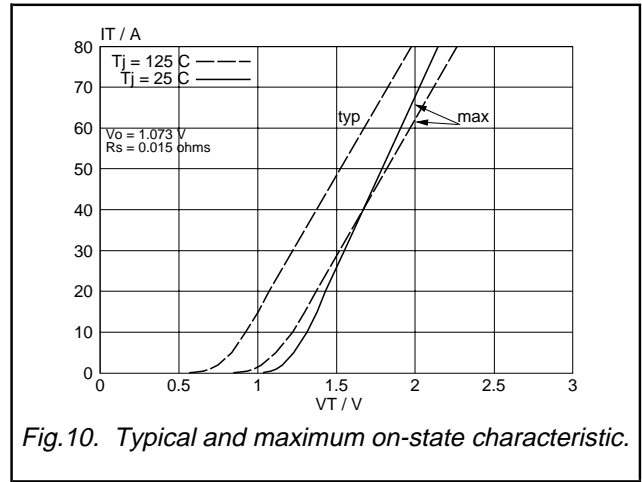
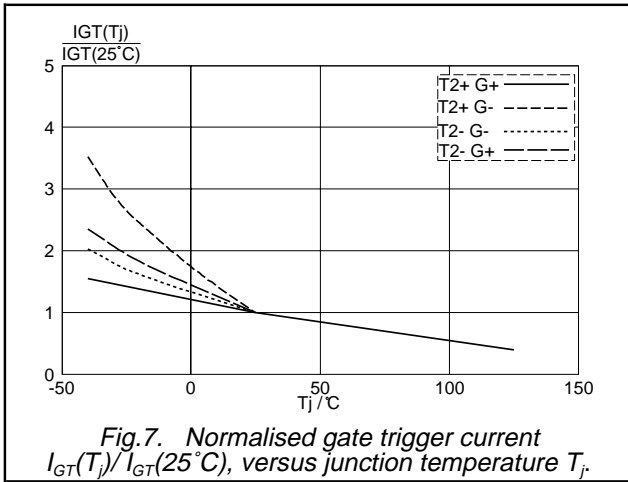

Fig.6. Normalised gate trigger voltage  $V_{GT}(T_j) / V_{GT}(25^\circ C)$ , versus junction temperature  $T_j$ .

Triacs

MAC223 series



Triacs

MAC223 series

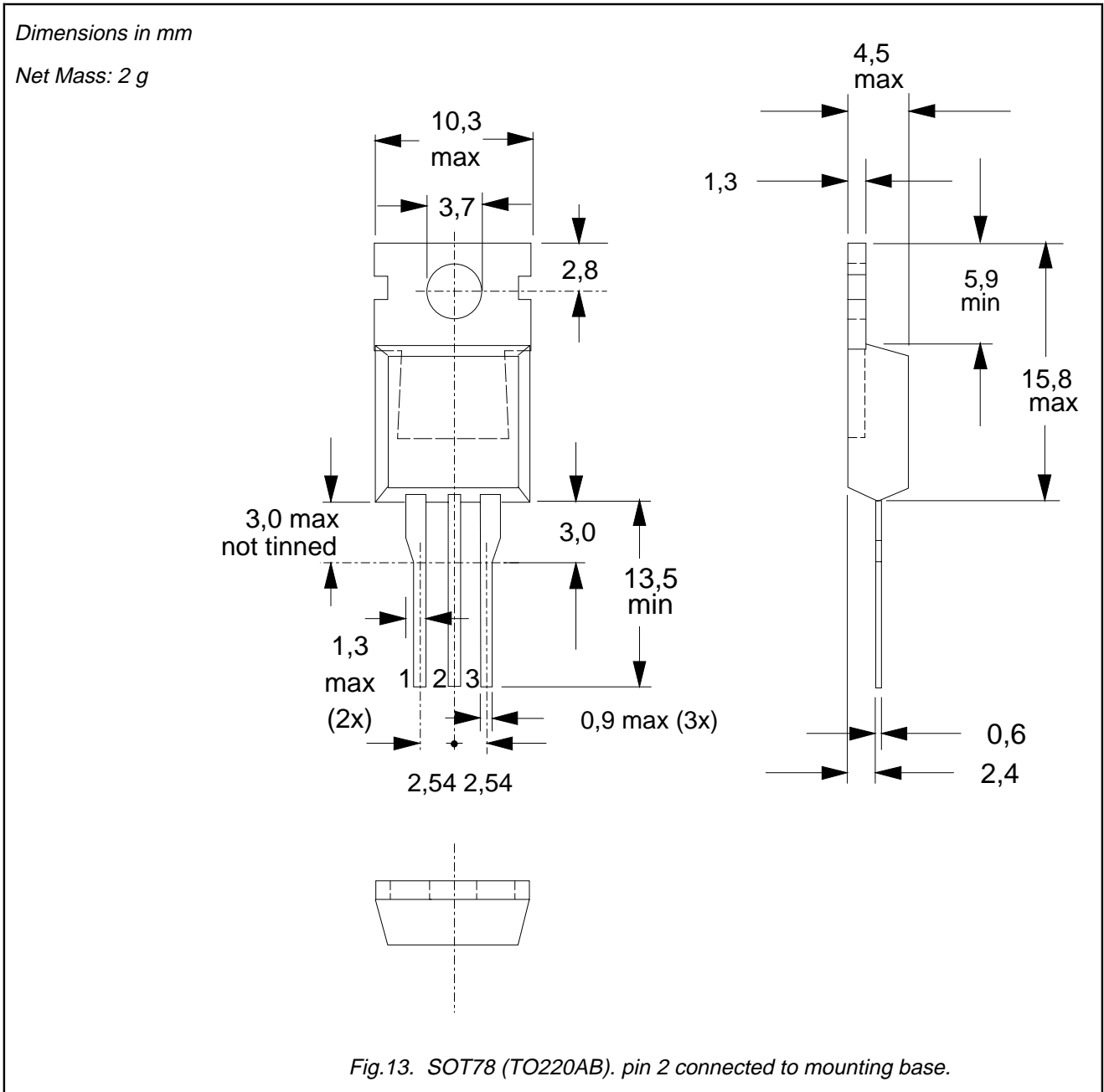

Notes

1. Refer to mounting instructions for SOT78 (TO220) envelopes.
2. Epoxy meets UL94 V0 at 1/8".

## Triacs

## MAC223 series

**DEFINITIONS**

|  |   |
|--|---|
| <b>Data sheet status</b>   |   |
| Objective specification  | This data sheet contains target or goal specifications for product development.       |
| Preliminary specification  | This data sheet contains preliminary data; supplementary data may be published later. |
| Product specification  | This data sheet contains final product specifications.                                |
| <b>Limiting values</b>   |   |
| Limiting values are given in accordance with the Absolute Maximum Rating System (IEC 134). Stress above one or more of the limiting values may cause permanent damage to the device. These are stress ratings only and operation of the device at these or at any other conditions above those given in the Characteristics sections of this specification is not implied. Exposure to limiting values for extended periods may affect device reliability. |   |
| <b>Application information</b>   |   |
| Where application information is given, it is advisory and does not form part of the specification.  |   |
| © Philips Electronics N.V. 2001  |   |
| All rights are reserved. Reproduction in whole or in part is prohibited without the prior written consent of the copyright owner.  |   |
| The information presented in this document does not form part of any quotation or contract, it is believed to be accurate and reliable and may be changed without notice. No liability will be accepted by the publisher for any consequence of its use. Publication thereof does not convey nor imply any license under patent or other industrial or intellectual property rights.   |   |

**LIFE SUPPORT APPLICATIONS**

These products are not designed for use in life support appliances, devices or systems where malfunction of these products can be reasonably expected to result in personal injury. Philips customers using or selling these products for use in such applications do so at their own risk and agree to fully indemnify Philips for any damages resulting from such improper use or sale.

# ***Philips Semiconductors – a worldwide company***

## **Contact information**

For additional information please visit <http://www.semiconductors.philips.com>. Fax: +31 40 27 24825

For sales offices addresses send e-mail to: [sales.addresses@www.semiconductors.philips.com](mailto:sales.addresses@www.semiconductors.philips.com).

© Koninklijke Philips Electronics N.V. 2001

SCA73

All rights are reserved. Reproduction in whole or in part is prohibited without the prior written consent of the copyright owner.

The information presented in this document does not form part of any quotation or contract, is believed to be accurate and reliable and may be changed without notice. No liability will be accepted by the publisher for any consequence of its use. Publication thereof does not convey nor imply any license under patent- or other industrial or intellectual property rights.

Printed in The Netherlands

XXXXXX/700/02/pp8

Date of release: July 2001

Document order number: 9397 750 08942

*Let's make things better.*

**Philips  
Semiconductors**



**PHILIPS**