

DE1B3KX331KA4BL01

" # " indicates a package specification code.

Available  Complies with RoHS

< List of part numbers with package codes >
DE1B3KX331KA4BL01

Shape

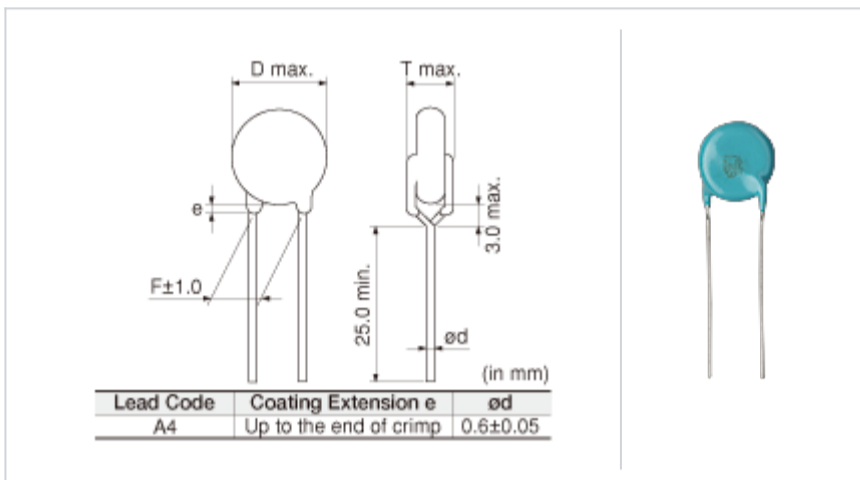

L size or outer diameter D (mm)	8.0 mm max.
Lead spacing F	10 ± 1.0mm
Thickness T	7.0mm max.
Lead diameter d	0.6 ± 0.05mm
Paint dripping e	Up to the end of crimp

Specifications

Capacitance	330pF ± 10%
Rated voltage	250Vac
Temperature characteristics (complied standard)	B(JIS)
Capacitance change rate	± 10%
Temperature range of temperature characteristics	-25 to 85
Operating temperature range	-25 to 125

Notes

X1/Y1 Class Certified Products

References

Packaging	Specifications	Minimum quantity
	Packing in bulk	250

⚠ Attention

- 1.This datasheet is downloaded from the website of Murata Manufacturing Co., Ltd. Therefore, it ' s specifications are subject to change or our products in it may be discontinued without advance notice. Please check with our sales representatives or product engineers before ordering.
- 2.This datasheet has only typical specifications because there is no space for detailed specifications. Therefore, please review our product specifications or consult the approval sheet for product specifications before ordering.