

SIOV metal oxide varistors

Housed (ThermoFuse) varistors, AdvancedD series

Series/Type: **ETFV20**
Date: April 2011

Construction

- Round varistor element, leaded
- Coating: epoxy resin, flame-retardant to UL 94 V-0
- Terminals: tinned copper wire, metal compound wire
- Housing: thermoplastic, flame-retardant to UL 94 V-0

Features

- Wide operating voltage range 130 ... 420 V_{RMS}
- Self-protected under abnormal overvoltage conditions
- High-energy Advanced series E2

Approvals

- UL
- IEC
- VDE

Applications

- Air conditioner, refrigerator, TV, etc.
- Power meter, inverter, telecom equipment, etc.
- Transient voltage surge suppressors (TVSS)
- Solar inverter

Delivery mode

- Bulk (standard)

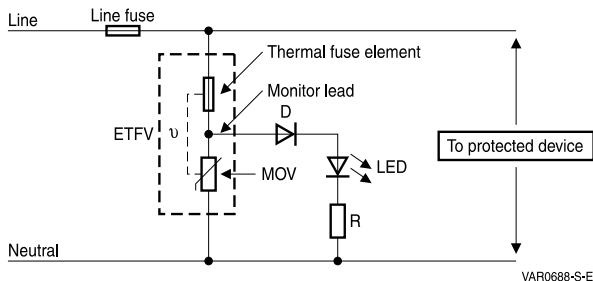
Typical applications

General technical data

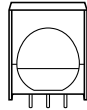
Climatic category	to IEC 60068-1	40/85/56	
Operating temperature	to IEC 61051	-40 ... + 85	°C
Storage temperature		-40 ... + 85	°C
Electric strength	to IEC 61051	≥ 2.5	kV _{RMS}
Insulation resistance	to IEC 61051	≥ 100	MΩ
Response time		< 25	ns

Electrical specifications and ordering codes
Maximum ratings ($T_A = 85\text{ }^\circ\text{C}$)

Ordering code	Type (untaped) SIOV-	V_{RMS} V	V_{DC} V	i_{max} (8/20 μs) A	W_{max} (2 ms) J	P_{max} W
B72220T2131K101	ETFBV20K130E2	130	170	10000	100	1.0
B72220T2141K101	ETFBV20K140E2	140	180	10000	110	1.0
B72220T2151K101	ETFBV20K150E2	150	200	10000	120	1.0
B72220T2171K101	ETFBV20K175E2	175	225	10000	135	1.0
B72220T2211K101	ETFBV20K210E2	210	270	10000	160	1.0
B72220T2231K101	ETFBV20K230E2	230	300	10000	180	1.0
B72220T2251K101	ETFBV20K250E2	250	320	10000	195	1.0
B72220T2271K101	ETFBV20K275E2	275	350	10000	215	1.0
B72220T2301K101	ETFBV20K300E2	300	385	10000	250	1.0
B72220T2321K101	ETFBV20K320E2	320	420	10000	273	1.0
B72220T2351K101	ETFBV20K350E2	350	460	10000	273	1.0
B72220T2381K101	ETFBV20K385E2	385	505	10000	273	1.0
B72220T2421K101	ETFBV20K420E2	420	560	10000	273	1.0

Characteristics ($T_A = 25\text{ }^\circ\text{C}$)

Ordering code	Type (untaped) SIOV-	V_V (1 mA) V	ΔV_V (1 mA) %	$V_{c,max}$ (i_c) V	i_c A	C_{typ} (1 kHz) pF
B72220T2131K101	ETFBV20K130E2	205	± 10	340	100	1340
B72220T2141K101	ETFBV20K140E2	220	± 10	360	100	1240
B72220T2151K101	ETFBV20K150E2	240	± 10	395	100	1160
B72220T2171K101	ETFBV20K175E2	270	± 10	455	100	1000
B72220T2211K101	ETFBV20K210E2	330	± 10	545	100	835
B72220T2231K101	ETFBV20K230E2	360	± 10	595	100	760
B72220T2251K101	ETFBV20K250E2	390	± 10	650	100	700
B72220T2271K101	ETFBV20K275E2	430	± 10	710	100	630
B72220T2301K101	ETFBV20K300E2	470	± 10	775	100	580
B72220T2321K101	ETFBV20K320E2	510	± 10	840	100	540
B72220T2351K101	ETFBV20K350E2	560	± 10	910	100	500
B72220T2381K101	ETFBV20K385E2	620	± 10	1025	100	450
B72220T2421K101	ETFBV20K420E2	680	± 10	1120	100	420

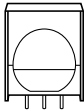

Housed varistors

ETFV20

ThermoFuse varistors, ETFV20 series

Dimensional drawings

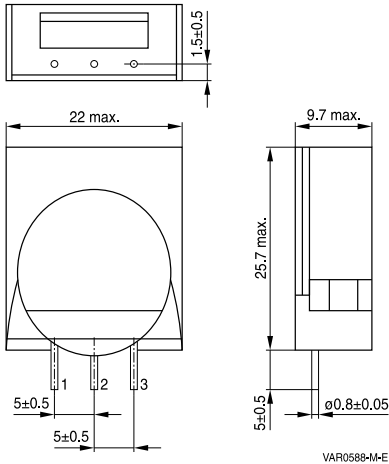

Weight

Nominal diameter mm	V _{RMS} V	Weight g
20	130 ... 420	5.2 ... 8.4

Lead configuration

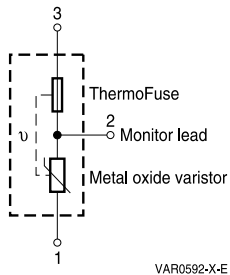

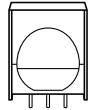

Reliability data

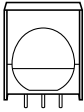
Test	Test methods/conditions	Requirement
Varistor voltage	The voltage between two terminals with the specified measuring current applied is called V_V (1 mA _{DC} @ 0.2 ... 2 s).	To meet the specified value
Clamping voltage	The maximum voltage between two terminals with the specified standard impulse current (8/20 μ s) applied.	To meet the specified value
Endurance at upper category temperature	1000 h at UCT After having continuously applied the maximum allowable AC voltage at UCT ± 2 °C for 1000 h, the specimen shall be stored at room temperature and normal humidity for 1 to 2 h. Thereafter, the change of V_V shall be measured.	$ \Delta V/V (1 \text{ mA}) \leq 10\%$
Surge current derating, 8/20 μ s	10 surge currents (8/20 μ s), unipolar, interval 30 s, amplitude corresponding to derating curve for 10 impulses at 20 μ s	$ \Delta V/V (1 \text{ mA}) \leq 10\%$ (measured in direction of surge current) No visible damage
Surge current derating, 2 ms	10 surge currents (2 ms), unipolar, interval 120 s, amplitude corresponding to derating curve for 10 impulses at 2 ms	$ \Delta V/V (1 \text{ mA}) \leq 10\%$ (measured in direction of surge current) No visible damage
Electric strength	IEC 61051-1, test 4.9.2 Metal balls method, 2500 V _{RMS} , 60 s The varistor is placed in a container holding 1.6 \pm 0.2 mm diameter metal balls such that only the terminations of the varistor are protruding. The specified voltage shall be applied between both terminals of the specimen connected together and the electrode inserted between the metal balls.	No breakdown

Housed varistors
ETFV20
ThermoFuse varistors, ETFV20 series

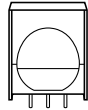
Test	Test methods/conditions	Requirement
Climatic sequence	<p>The specimen shall be subjected to:</p> <p>a) dry heat at UCT, 16 h, IEC 60068-2-2, test Ba</p> <p>b) damp heat, 1st cycle: 55 °C, 93% r. H., 24 h, IEC 60068-2-30, test Db</p> <p>c) cold, LCT, 2 h, IEC 60068-2-1, test Aa</p> <p>d) damp heat, additional 5 cycles: 55 °C/25 °C, 93% r. H., 24 h/cycle, IEC 60068-2-30, test Db.</p> <p>Then the specimen shall be stored at room temperature and normal humidity for 1 to 2 h.</p> <p>Thereafter, the change of V_V shall be measured. Thereafter, insulation resistance R_{ins} shall be measured at $V = 500$ V.</p>	$ \Delta V/V (1 \text{ mA}) \leq 10\%$ $R_{ins} \geq 100 \text{ M}\Omega$
Rapid change of temperature	IEC 60068-2-14, test Na, LCT/UCT, dwell time 30 min, 5 cycles	$ \Delta V/V (1 \text{ mA}) \leq 5\%$ No visible damage
Damp heat, steady state	IEC 60068-2-78, test Ca The specimen shall be subjected to 40 ± 2 °C, 90 to 95% r. H. for 56 days without load / with 10% of the maximum continuous DC operating voltage V_{DC} . Then stored at room temperature and normal humidity for 1 to 2 h. Thereafter, the change of V_V shall be measured. Thereafter, insulation resistance R_{ins} shall be measured at $V = 500$ V (insulated varistors only).	$ \Delta V/V (1 \text{ mA}) \leq 10\%$ $R_{ins} \geq 100 \text{ M}\Omega$

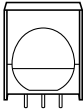

Test	Test methods/conditions	Requirement
Solderability	<p>IEC 60068-2-20, test Ta, method 1 with modified conditions for lead-free solder alloys: 245 °C, 3 s:</p> <p>After dipping the terminals to a depth of approximately 3 mm from the body in a soldering bath of 245 °C for 3 s, the terminals shall be visually examined.</p>	<p>The inspection shall be carried out under adequate light with normal eyesight or with the assistance of a magnifier capable of giving a magnification of 4 to 10 times. The dipped surface shall be covered with a smooth and bright solder coating with no more than small amounts of scattered imperfections such as pinholes or un-wetted or de-wetted areas. These imperfections shall not be concentrated in one area.</p>
Resistance to soldering heat	<p>IEC 60068-2-20, test Tb, method 1A, 260 °C, 10 s:</p> <p>Each lead shall be dipped into a solder bath having a temperature of 260 ±5 °C to a point 2.0 to 2.5 mm from the body of the specimen, be held there for 10 ±1 s and then be stored at room temperature and normal humidity for 1 to 2 h.</p> <p>The change of V_V shall be measured and the specimen shall be visually examined.</p>	<p>$\Delta V/V (1 \text{ mA}) \leq 5\%$</p> <p>No visible damage</p>
Tensile strength	<p>IEC 60068-2-21, test Ua1</p> <p>After gradually applying the force specified below and keeping the unit fixed for 10 s, the terminal shall be visually examined for any damage.</p> <p>Force for wire diameter:</p> <p>0.6 mm = 10 N 0.8 mm = 10 N 1.0 mm = 20 N</p>	<p>$\Delta V/V (1 \text{ mA}) \leq 5\%$</p> <p>No break of solder joint, no wire break</p>

Housed varistors
ETFV20
ThermoFuse varistors, ETFV20 series

Test	Test methods/conditions	Requirement
Vibration	IEC 60068-2-6, test Fc, method B4 Frequency range: 10 ... 55 Hz Amplitude: 0.75 mm or 98 m/s ² Duration: 6 h (3 · 2 h) Pulse: sine wave After repeatedly applying a single harmonic vibration according to the table above. The change of V_v shall be measured and the specimen shall be visually examined.	$ \Delta V/V (1 \text{ mA}) \leq 5\%$ No visible damage
Bump	IEC 60068-2-29, test Eb Pulse duration: 6 ms Max. acceleration: 400 m/s ² Number of bumps: 4000 Pulse: half sine	$ \Delta V/V (1 \text{ mA}) \leq 5\%$ No visible damage
Fire hazard	IEC 60695-11-5 (needle flame test) Severity: vertical 10 s	5 s max.

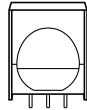

Test	Test methods/conditions	Requirement																																										
Abnormal overvoltage test	The device is designed to meet the limited current abnormal overvoltage condition, outlined in section 39.4 of UL 1449, 3 rd edition. Detailed test voltage applied onto the device for different types as in the following table:	Any of these phenomena shall not be observed, or this specimen will be judged as failed part: <ol style="list-style-type: none"> 1. Emission of flame, molten metal, glowing or flaming particles through any openings (pre-existed or created as a result of the test) in the product. 2. Charring, glowing, or flaming of the supporting surface, tissue paper, or cheesecloth. 3. Ignition of the enclosure. 4. Creation of any openings in the enclosure that result in accessibility of live parts, when evaluated in accordance with accessibility of live parts test in section 58.2 of UL1449, 3rd edition. 																																										
	<table border="1"> <thead> <tr> <th>Type</th> <th>Device rating V</th> <th>Test voltage V</th> </tr> </thead> <tbody> <tr> <td>ETFV20K130E2</td> <td>130</td> <td>260</td> </tr> <tr> <td>ETFV20K140E2</td> <td>140</td> <td>280</td> </tr> <tr> <td>ETFV20K150E2</td> <td>150</td> <td>300</td> </tr> <tr> <td>ETFV20K175E2</td> <td>175</td> <td>350</td> </tr> <tr> <td>ETFV20K210E2</td> <td>210</td> <td>420</td> </tr> <tr> <td>ETFV20K230E2</td> <td>230</td> <td>415</td> </tr> <tr> <td>ETFV20K250E2</td> <td>250</td> <td>500</td> </tr> <tr> <td>ETFV20K275E2</td> <td>275</td> <td>480</td> </tr> <tr> <td>ETFV20K300E2</td> <td>300</td> <td>600</td> </tr> <tr> <td>ETFV20K320E2</td> <td>320</td> <td>600</td> </tr> <tr> <td>ETFV20K350E2</td> <td>350</td> <td>600</td> </tr> <tr> <td>ETFV20K385E2</td> <td>385</td> <td>600</td> </tr> <tr> <td>ETFV20K420E2</td> <td>420</td> <td>600</td> </tr> </tbody> </table>		Type	Device rating V	Test voltage V	ETFV20K130E2	130	260	ETFV20K140E2	140	280	ETFV20K150E2	150	300	ETFV20K175E2	175	350	ETFV20K210E2	210	420	ETFV20K230E2	230	415	ETFV20K250E2	250	500	ETFV20K275E2	275	480	ETFV20K300E2	300	600	ETFV20K320E2	320	600	ETFV20K350E2	350	600	ETFV20K385E2	385	600	ETFV20K420E2	420	600
	Type		Device rating V	Test voltage V																																								
	ETFV20K130E2		130	260																																								
	ETFV20K140E2		140	280																																								
	ETFV20K150E2		150	300																																								
	ETFV20K175E2		175	350																																								
	ETFV20K210E2		210	420																																								
	ETFV20K230E2		230	415																																								
	ETFV20K250E2		250	500																																								
	ETFV20K275E2		275	480																																								
	ETFV20K300E2		300	600																																								
	ETFV20K320E2		320	600																																								
	ETFV20K350E2		350	600																																								
ETFV20K385E2	385	600																																										
ETFV20K420E2	420	600																																										

Note:

UCT = Upper category temperature

LCT = Lower category temperature

 R_{ins} = Insulation resistance

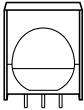

v/i characteristics

$v = f(i)$ for explanation of the characteristics refer to "General technical information", chapter 1.6.3
 A = Leakage current, B = Protection level } for worst-case varistor tolerances

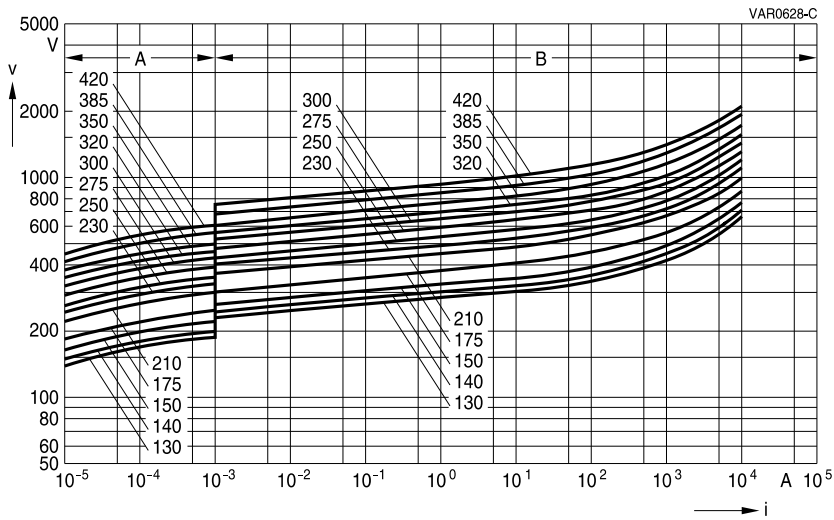

SIOV-ETFV20 ... E2

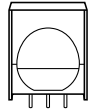

Derating curves

Maximum surge current $i_{max} = f(t_r, \text{pulse train})$

For explanation of the derating curves refer to "General technical information", section 1.8.1

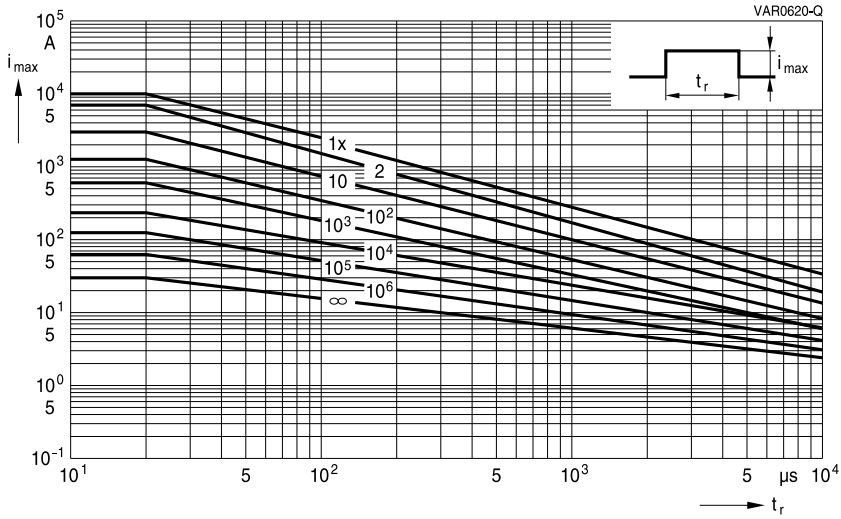

SIOV-ETFV20 ... E2

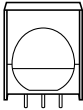

Cautions and warnings

General

1. EPCOS metal oxide varistors are designed for specific applications and should not be used for purposes not identified in our specifications, application notes and data books unless otherwise agreed with EPCOS during the design-in-phase.
2. Ensure suitability of SIOVs through reliability testing during the design-in phase. SIOVs should be evaluated taking into consideration worst-case conditions.
3. For applications of SIOVs in line-to-ground circuits based on various international and local standards there are restrictions existing or additional safety measures required.

Storage

1. Store SIOVs only in original packaging. Do not open the package before storage.
2. Storage conditions in original packaging:
 Storage temperature: $-25\text{ }^{\circ}\text{C} \dots +45\text{ }^{\circ}\text{C}$,
 Relative humidity: $<75\%$ annual average,
 $<95\%$ on maximum 30 days a year.
 Dew precipitation: is to be avoided.
3. Avoid contamination of an SIOV's during storage, handling and processing.
4. Avoid storage of SIOVs in harmful environments that can affect the function during long-term operation (examples given under operation precautions).
5. The SIOV type series should be soldered within the time specified:

SIOV-S, -Q, -LS, -B, -SFS	24 months
ETFV	12 months.

Handling

1. SIOVs must not be dropped.
2. Components must not be touched with bare hands. Gloves are recommended.
3. Avoid contamination of the surface of SIOV electrodes during handling, be careful of the sharp edge of SIOV electrodes.

Soldering (where applicable)

1. Use rosin-type flux or non-activated flux.
2. Insufficient preheating may cause ceramic cracks.
3. Rapid cooling by dipping in solvent is not recommended.
4. Complete removal of flux is recommended.

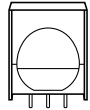

Mounting

1. Potting, sealing or adhesive compounds can produce chemical reactions in the SIOV ceramic that will degrade the component's electrical characteristics.
2. Overloading SIOVs may result in ruptured packages and expulsion of hot materials. For this reason SIOVs should be physically shielded from adjacent components.

Operation

1. Use SIOVs only within the specified temperature operating range.
2. Use SIOVs only within the specified voltage and current ranges.
3. Environmental conditions must not harm SIOVs. Use SIOVs only in normal atmospheric conditions. Avoid use in deoxidizing gases (chlorine gas, hydrogen sulfide gas, ammonia gas, sulfuric acid gas etc), corrosive agents, humid or salty conditions. Contact with any liquids and solvents should be prevented.

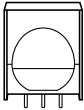
Symbols and terms

Symbol	Term
C	Capacitance
C_{typ}	Typical capacitance
i	Current
i_c	Current at which $V_{c, max}$ is measured
I_{leak}	Leakage current
i_{max}	Maximum surge current (also termed peak current)
I_{max}	Maximum discharge current to IEC 61643-1
I_{nom}	Nominal discharge current to IEC 61643-1
LCT	Lower category temperature
L_{typ}	Typical inductance
P_{max}	Maximum average power dissipation
R_{ins}	Insulation resistance
R_{min}	Minimum resistance
T_A	Ambient temperature
t_r	Duration of equivalent rectangular wave
UCT	Upper category temperature
v	Voltage
V_{clamp}	Clamping voltage
$V_{c, max}$	Maximum clamping voltage at specified current i_c
V_{DC}	DC operating voltage
V_{jump}	Maximum jump start voltage
V_{max}	Maximum voltage
V_{op}	Operating voltage
V_{RMS}	AC operating voltage, root-mean-square value
$V_{RMS, op, max}$	Root-mean-square value of max. DC operating voltage incl. ripple current
V_{surge}	Super imposed surge voltage
V_V	Varistor voltage
ΔV_V	Tolerance of varistor voltage
W_{LD}	Maximum load dump
W_{max}	Maximum energy absorption
e	Lead spacing

All dimensions are given in mm.

The commas used in numerical values denote decimal points.

Important notes

The following applies to all products named in this publication:

1. Some parts of this publication contain **statements about the suitability of our products for certain areas of application**. These statements are based on our knowledge of typical requirements that are often placed on our products in the areas of application concerned. We nevertheless expressly point out **that such statements cannot be regarded as binding statements about the suitability of our products for a particular customer application**. As a rule, EPCOS is either unfamiliar with individual customer applications or less familiar with them than the customers themselves. For these reasons, it is always ultimately incumbent on the customer to check and decide whether an EPCOS product with the properties described in the product specification is suitable for use in a particular customer application.
2. We also point out that **in individual cases, a malfunction of electronic components or failure before the end of their usual service life cannot be completely ruled out in the current state of the art, even if they are operated as specified**. In customer applications requiring a very high level of operational safety and especially in customer applications in which the malfunction or failure of an electronic component could endanger human life or health (e.g. in accident prevention or lifesaving systems), it must therefore be ensured by means of suitable design of the customer application or other action taken by the customer (e.g. installation of protective circuitry or redundancy) that no injury or damage is sustained by third parties in the event of malfunction or failure of an electronic component.
3. **The warnings, cautions and product-specific notes must be observed.**
4. In order to satisfy certain technical requirements, **some of the products described in this publication may contain substances subject to restrictions in certain jurisdictions (e.g. because they are classed as hazardous)**. Useful information on this will be found in our Material Data Sheets on the Internet (www.epcos.com/material). Should you have any more detailed questions, please contact our sales offices.
5. We constantly strive to improve our products. Consequently, **the products described in this publication may change from time to time**. The same is true of the corresponding product specifications. Please check therefore to what extent product descriptions and specifications contained in this publication are still applicable before or when you place an order. We also **reserve the right to discontinue production and delivery of products**. Consequently, we cannot guarantee that all products named in this publication will always be available. The aforementioned does not apply in the case of individual agreements deviating from the foregoing for customer-specific products.
6. Unless otherwise agreed in individual contracts, **all orders are subject to the current version of the "General Terms of Delivery for Products and Services in the Electrical Industry" published by the German Electrical and Electronics Industry Association (ZVEI)**.
7. The trade names EPCOS, BAOKE, Alu-X, CeraDiode, CSMP, CSSP, CTVS, DeltaCap, DigiSiMic, DSSP, FormFit, MiniBlue, MiniCell, MKK, MKD, MLSC, MotorCap, PCC, PhaseCap, PhaseCube, PhaseMod, PhiCap, SIFERRIT, SIFI, SIKOREL, SilverCap, SIMDAD, SiMic, SIMID, SineFormer, SIOV, SIP5D, SIP5K, ThermoFuse, WindCap are **trade-marks registered or pending** in Europe and in other countries. Further information will be found on the Internet at www.epcos.com/trademarks.