

Material Guard, cover: Resin (PPE+PS) UL file no. E82268 94V-0 Filter: Polyurethane foam UL file no. E74916 (S) 94HF-1  
 PPI: Particles Per Inch Indicates the number of holes per inch. Note that the higher the number, the finer the grain of the sponge.

**60 mm sq. type**

Model no.	Mass (g)
109-1003F13 (13 PPI)	11
109-1003F20 (20 PPI)	
109-1003F30 (30 PPI)	
109-1003F40 (40 PPI)	
Replacement filter model no.	Quantity
109-1003M13 (13 PPI)	5
109-1003M20 (20 PPI)	
109-1003M30 (30 PPI)	
109-1003M40 (40 PPI)	



**Airflow - Static pressure characteristics**

Measured with our double chamber measuring device (120 mm sq. type)

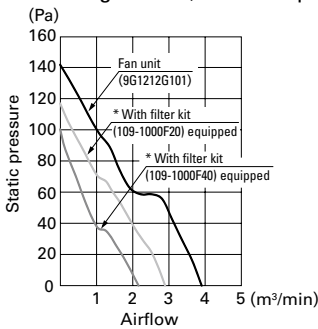

Applied voltage: 12 VDC

\* Filter kit is attached on air inlet side of fan.

**Mounting example**

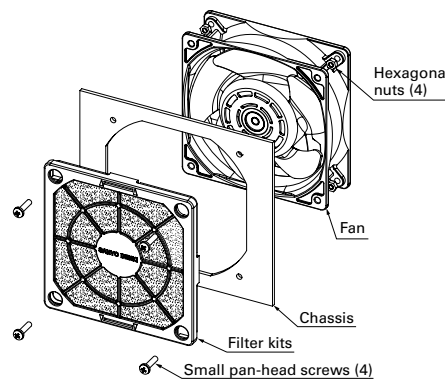

**Filter replacement (example)**

Replacement filters can be replaced by taking off the front part of the filter kit. There is no need to remove the screws.

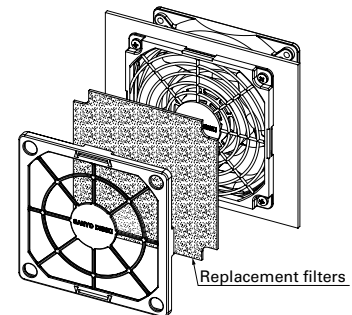

- Filter kit is one of the option to keep air in the chassis clean filtering dust in external atmosphere when pulling-air cooling is implemented. The filter kit is hooked up through mounting hole of fan frame with screw as well as finger guard. Some performances (airflow & static pressure) of the fan motor decreases when filter kit is hooked up.
- This Filter Kit is composed of 3 components, including a guard, a filter and a cover. It is delivered as a finished product at delivery, saving assembly time when mounting. It can be mounted by inserting a screw in the apertures of the cover.
- The filter and cover can be easily removed from the guard with one touch. There is no need for fan removal when undertaking maintenance. ● Operating temperature limit is between -10 to +60°C. (non condensing)
- The filter will deteriorate with age, and the level of deterioration will vary upon usage conditions. Please be aware that the filter has a greater tendency to deteriorate under high temperature and humidity. For long-term storage, please store under the temperature range of 10 to 30°C, humidity range of 20 to 65%. Usage and storage period is approximately 2 years.
- Cooling ability decreases with filter contamination due to clogging. Filter replacement is recommended approximately every six months of usage. Please replace the filter if deterioration or clogging is seen at inspection.
- When replacing the filter, please use genuine SANYO DENKI filters. ● Do not water-wash the filter.
- Avoid use and storage under high temperature or humidity, direct sunlight or exposure to ultraviolet light, or in corrosive gas. ● No nuts or screws for use in attachment included.