



### FEATURES

- RF frequency: 700 MHz to 3000 MHz, continuous
- LO input frequency: 200 MHz to 2700 MHz, high-side or low-side injection
- IF range: 40 MHz to 500 MHz
- Power conversion gain of 9.0 dB
- Phase noise performance of  $-144$  dBc/Hz at 800 kHz offset supporting stringent GSM standards in both 800 MHz to 900 MHz and 1800 MHz to 1900 MHz bands
- Single-sideband (SSB) noise figure of 11.3 dB
- Input IP3 of 30 dBm
- Input P1dB of 10.6 dBm
- Typical LO input drive of 0 dBm
- Single-ended, 50  $\Omega$  RF port
- Single-ended or balanced LO input port
- Serial port interface (SPI) control on all functions
- Exposed pad, 7 mm  $\times$  7 mm, 48-lead LFCSP

### APPLICATIONS

- Multiband/multistandard cellular base station diversity receivers
- Wideband radio link diversity downconverters
- Multimode cellular extenders and picocells

### GENERAL DESCRIPTION

The **ADRF6614** is a dual radio frequency (RF) mixer and intermediate frequency (IF) amplifier with an integrated phase-locked loop (PLL) and voltage controlled oscillators (VCOs). The **ADRF6614** uses revolutionary broadband square wave limiting local oscillator (LO) amplifiers to achieve a wideband RF bandwidth of 700 MHz to 3000 MHz. Unlike narrow-band sine wave LO amplifier solutions, the LO can be applied above or below the RF input over a wide bandwidth. Energy storage elements are not utilized in the LO amplifier, thus dc current consumption also decreases with decreasing LO frequency.

The **ADRF6614** utilizes highly linear, doubly balanced passive mixer cores with integrated RF and LO balancing circuits to allow single-ended operation. Integrated RF baluns allow optimal performance over the 700 MHz to 3000 MHz RF input frequency. The balanced passive mixer arrangement provides outstanding LO to RF and LO to IF leakages, excellent RF to IF isolation, and excellent intermodulation performance over the full RF bandwidth.

The balanced mixer cores provide extremely high input linearity, allowing the device to be used in demanding wideband applications where in-band blocking signals may otherwise result in the degradation of dynamic range. Noise performance under blocking is comparable to narrow-band passive mixer designs. High linearity

### FUNCTIONAL BLOCK DIAGRAM

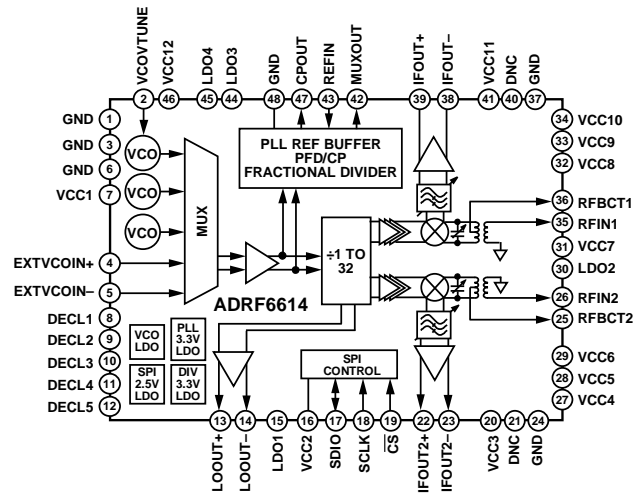

Figure 1.

IF buffer amplifiers follow the passive mixer cores, yielding typical power conversion gains of 9.0 dB, and can be matched to a wide range of output impedances.

The PLL architecture supports both integer-N and fractional-N operation and can generate the entire LO frequency range of 200 MHz to 2700 MHz using an external reference input frequency anywhere in the range of 12 MHz to 320 MHz. An external loop filter provides flexibility in trading off phase noise vs. acquisition time. To reduce fractional spurs in fractional-N mode, a  $\Sigma$ - $\Delta$  modulator controls the post VCO-programmable divider. The device integrates six VCO cores, four of which provide complete frequency coverage between 200 MHz and 2700 MHz, and meet the GSM phase noise requirements in the 800 MHz and 900 MHz bands. Two additional GSM only cores enable the **ADRF6614** to meet the GSM phase noise requirements in the digital cellular system 1800 MHz (DCS1800) and personal communications service 1900 MHz (PCS1900) bands.

All features of the **ADRF6614** are controlled via a 3-wire SPI, resulting in optimum performance and minimum external components.

The **ADRF6614** is fabricated using a BiCMOS, high performance IC process. The device is available in a 7 mm  $\times$  7 mm, 48-lead LFCSP package and operates over a  $-40^{\circ}\text{C}$  to  $+85^{\circ}\text{C}$  temperature range. An evaluation board is available.

Rev. 0

[Document Feedback](#)

Information furnished by Analog Devices is believed to be accurate and reliable. However, no responsibility is assumed by Analog Devices for its use, nor for any infringements of patents or other rights of third parties that may result from its use. Specifications subject to change without notice. No license is granted by implication or otherwise under any patent or patent rights of Analog Devices. Trademarks and registered trademarks are the property of their respective owners.

## TABLE OF CONTENTS

Features .....	1	Spurious Performance .....	32
Applications.....	1	Theory of Operation .....	34
Functional Block Diagram .....	1	RF Subsystem.....	34
General Description .....	1	External LO Generation .....	34
Revision History .....	2	Internal LO Generation .....	34
Specifications.....	3	Applications Information .....	38
RF Specifications .....	3	Basic Connections by Pin Description .....	39
Synthesizer/PLL Specifications.....	4	Mixer Optimization .....	40
VCO Specifications, Open-Loop.....	7	RF Input Balun Insertion Loss Optimization.....	40
Logic Input and Power Specifications .....	8	IIP3 Optimization .....	40
Digital Logic Specifications.....	9	VGS Programming.....	41
Absolute Maximum Ratings.....	10	Low-Pass Filter Programming.....	41
Thermal Resistance .....	10	GSM Mode of Operation.....	43
ESD Caution.....	10	Register Summary .....	44
Pin Configuration and Function Descriptions.....	11	Register Details .....	45
Typical Performance Characteristics .....	13	Evaluation Board .....	55
Mixer, High Performance Mode.....	13	Outline Dimensions .....	61
Mixer, High Efficiency Mode.....	22	Ordering Guide .....	61
Synthesizer.....	23		

## REVISION HISTORY

3/16—Revision 0: Initial Version

## SPECIFICATIONS

### RF SPECIFICATIONS

$T_A = 25^\circ\text{C}$ ,  $f_{RF} = 1900\text{ MHz}$ ,  $f_{LO} = 1697\text{ MHz}$ ,  $Z_O = 50\ \Omega$ , frequency of the reference ( $f_{REF}$ ) = 122.88 MHz,  $f_{REF}$  power = 4 dBm,  $f_{PFD} = 1.536\text{ MHz}$ , low-side LO injection, optimum RF balun (RFB) and low-pass filter (LPF) settings, unless otherwise noted.

**Table 1. High Performance Mode**

Parameter	Test Conditions/Comments	Min	Typ	Max	Unit
<b>RF INTERFACE</b>					
Return Loss	Tunable to >20 dB broadband via serial port		17.9		dB
Input Impedance			50		$\Omega$
RF Frequency Range ( $f_{RF}$ )		700		3000	MHz
<b>IF OUTPUT INTERFACE</b>					
Output Impedance	Differential impedance, $f = 200\text{ MHz}$		300  1.5		$\Omega$   pF
IF Frequency Range ( $f_{IF}$ )		40		500	MHz
DC Bias Voltage <sup>1</sup>	Externally generated		IFOUTx $\pm$		V
<b>EXTERNAL LO INPUT</b>					
External LO Power Input	External VCO input supports divide by 1, 2, 4, 8, 16, and 32 Low-side or high-side LO, internally or externally generated	-5	0	+5	dBm
Return Loss			-11		dB
Input Impedance			50		$\Omega$
External VCO Input Frequency		250		5700	MHz
LO Frequency Range		250		2850	MHz
<b>DYNAMIC PERFORMANCE</b>					
Power Conversion Gain	4:1 IF port transformer and printed circuit board (PCB) loss removed		9.0		dB
Voltage Conversion Gain	$Z_{SOURCE} = 50\ \Omega$ , differential $Z_{LOAD} = 200\ \Omega$		15.0		dB
SSB Noise Figure			11.3		dB
IF Output Phase Noise Under Blocking	10 dBm blocker present 10 MHz above desired the RF input, $f_{RF} = 1900\text{ MHz}$ , $f_{BLOCK} = 1910\text{ MHz}$ , $f_{LO} = 1697\text{ MHz}$ , $f_{IF} = 203\text{ MHz}$ , $f_{BLOCKER} = 213\text{ MHz}$		-153		dBc/Hz
Input Third-Order Intercept (IIP3)	$f_{RF1} = 1900\text{ MHz}$ , $f_{RF2} = 1901\text{ MHz}$ , $f_{LO} = 1697\text{ MHz}$ , each RF tone at -10 dBm		30		dBm
Input Second-Order Intercept (IIP2)	$f_{RF1} = 1900\text{ MHz}$ , $f_{RF2} = 1950\text{ MHz}$ , $f_{LO} = 1697\text{ MHz}$ , each RF tone at -10 dBm		60		dBm
Input 1 dB Compression Point (P1dB)			10.6		dBm
LO to IF Output Leakage	Unfiltered IF output		-35		dBm
LO to RF Input Leakage			-45		dBm
RF to IF Output Isolation			-22		dB
IF/2 Spurious	-10 dBm input power		-72		dBc
IF/3 Spurious	-10 dBm input power		-69		dBc
<b>POWER INTERFACE</b>					
VCC1, VCC2, VCC7, VCC12		3.55	3.7	3.85	V
Supply Voltage			260		
Quiescent Current					
VCC3, VCC4, VCC5, VCC6, VCC8, VCC9, VCC10, VCC11, IFOUT1+, IFOUT1-, IFOUT2+, IFOUT2-		3.55	5	5.25	V
Supply Voltage			214		
Quiescent Current					
<b>LO OUTPUT (LOOUT+, LOOUT-)</b>					
Frequency Range ( $f_{LO}$ )	Adjustable via SPI in four steps, in 50 $\Omega$ balanced load	200		2700	MHz
Output Level		-5		+7	dBm
Output Impedance		Balanced		50	$\Omega$

<sup>1</sup> Supply voltage must be applied from the external circuit through choke inductors.

$T_A = 25^\circ\text{C}$ ,  $f_{RF} = 1900\text{ MHz}$ ,  $f_{LO} = 1697\text{ MHz}$ ,  $Z_O = 50\ \Omega$ ,  $f_{REF} = 122.88\text{ MHz}$ ,  $f_{REF}\text{ power} = 4\text{ dBm}$ ,  $f_{PFD} = 1.536\text{ MHz}$ , low-side LO injection, optimum RFB and LPF settings, unless otherwise noted.

Table 2. High Efficiency Mode

Parameter	Test Conditions/Comments	Min	Typ	Max	Unit
<b>DYNAMIC PERFORMANCE</b>					
Power Conversion Gain	4:1 IF port transformer and PCB loss removed		8.7		dB
Voltage Conversion Gain	$Z_{SOURCE} = 50\ \Omega$ , differential $Z_{LOAD} = 200\ \Omega$		14.7		dB
SSB Noise Figure			10.7		dB
IIP3	$f_{RF1} = 1900\text{ MHz}$ , $f_{RF2} = 1901\text{ MHz}$ , $f_{LO} = 1697\text{ MHz}$ , each RF tone at $-10\text{ dBm}$		20.5		dBm
IIP2	$f_{RF1} = 1900\text{ MHz}$ , $f_{RF2} = 1950\text{ MHz}$ , $f_{LO} = 1697\text{ MHz}$ , each RF tone at $-10\text{ dBm}$		53		dBm
Input P1dB			8.2		dBm
LO to IF Output Leakage	Unfiltered IF output		-45.0		dBm
LO to RF Input Leakage			-52.0		dBm
RF to IF Output Isolation			-22.8		dB
IF/2 Spurious	$-10\text{ dBm}$ input power		-58		dBc
IF/3 Spurious	$-10\text{ dBm}$ input power		-58		dBc
<b>POWER INTERFACE</b>					
VCC1, VCC2, VCC7, VCC12					
Supply Voltage		3.55	3.7	3.85	V
Quiescent Current			260		mA
VCC3, VCC4, VCC5, VCC6, VCC8, VCC9, VCC10, VCC11, IFOUT1+, IFOUT1-, IFOUT2+, IFOUT2-					
Supply Voltage		3.55	3.7	5.25	V
Quiescent Current			210		mA

## SYNTHESIZER/PLL SPECIFICATIONS

High performance mode,  $T_A = 25^\circ\text{C}$ , measured on LO output,  $f_{LO} = 1700\text{ MHz}$ ,  $Z_O = 50\ \Omega$ ,  $f_{REF} = 122.88\text{ MHz}$ ,  $f_{PFD} = 1.536\text{ MHz}$ ,  $f_{REF}\text{ power} (P_{REFIN}) = 4\text{ dBm}$ ,  $CSCALE = 8\text{ mA}$ ,  $bleed = 0\ \mu\text{A}$ ,  $ABLDLY = 0.9\text{ ns}$ , integer mode loop filter, unless otherwise noted.

Table 3. Integer Mode

Parameter	Test Conditions/Comments	Min	Typ	Max	Unit
<b>SYNTHESIZER SPECIFICATIONS</b>					
Frequency Range ( $f_{LO}$ )	Synthesizer specifications referenced to $1 \times LO$ Internally generated LO	200		2700	MHz
Figure of Merit (FOM) <sup>1</sup>	$P_{REFIN} = 6.5\text{ dBm}$		-223		dBc/Hz/Hz
Phase and Frequency Detector (PFD) Frequency ( $f_{PFD}$ )		0.8		70	MHz
Reference Spurs	$f_{PFD} = 1.536\text{ MHz}$ $1 \times f_{PFD}$ $4 \times f_{PFD}$ $>4 \times f_{PFD}$		-105		dBc
			-105		dBc
			-90		dBc
<b>CHARGE PUMP</b>					
Pump Current	Programmable to $250\ \mu\text{A}$ , $500\ \mu\text{A}$ , ..., $8\text{ mA}$		8	8.75	mA
Output Compliance Range		0.7		2.5	V
<b>REFERENCE CHARACTERISTICS</b>					
REFIN Input Frequency	REFIN, MUXOUT pins	12		320	MHz
REFIN Input Capacitance			4		pF
Reference Divider Value	Programmable to 0.5, 1, 2, 3, ..., 2047	0.5		2047	
MUXOUT Output Level	$V_{OL}$ (lock detect output selected)			0.25	V
	$V_{OH}$ (lock detect output selected)	2.7			V
MUXOUT Duty Cycle	Reference output selected		50		%

Parameter	Test Conditions/Comments	Min	Typ	Max	Unit
VCO_0					
Phase Noise, Locked	$f_{LO} = 2.55$ GHz				
	1 kHz offset		-87		dBc/Hz
	50 kHz offset		-94.9		dBc/Hz
	100 kHz offset		-103.3		dBc/Hz
	1 MHz offset		-132.9		dBc/Hz
	10 MHz offset		-154.1		dBc/Hz
	40 MHz offset		-155.2		dBc/Hz
Integrated Phase Noise	1 kHz to 40 MHz integration bandwidth		0.87		°rms
VCO_1					
Phase Noise, Locked	$f_{LO} = 2.22$ GHz				
	1 kHz offset		-90		dBc/Hz
	50 kHz offset		-98.4		dBc/Hz
	100 kHz offset		-106.5		dBc/Hz
	1 MHz offset		-136.1		dBc/Hz
	10 MHz offset		-154.8		dBc/Hz
	40 MHz offset		-155.5		dBc/Hz
Integrated Phase Noise	1 kHz to 40 MHz integration bandwidth		0.63		°rms
VCO_2					
Phase Noise, Locked	$f_{LO} = 1.9$ GHz				
	1 kHz offset		-90		dBc/Hz
	50 kHz offset		-98.1		dBc/Hz
	100 kHz offset		-109.8		dBc/Hz
	1 MHz offset		-137.1		dBc/Hz
	10 MHz offset		-155.7		dBc/Hz
	40 MHz offset		-156.2		dBc/Hz
Integrated Phase Noise	1 kHz to 40 MHz integration bandwidth		0.61		°rms
VCO_3					
Phase Noise, Locked	$f_{LO} = 1.6$ GHz				
	1 kHz offset		-89		dBc/Hz
	50 kHz offset		-97.2		dBc/Hz
	100 kHz offset		-107		dBc/Hz
	1 MHz offset		-136.2		dBc/Hz
	10 MHz offset		-155.7		dBc/Hz
	40 MHz offset		-157.3		dBc/Hz
Integrated Phase Noise	1 kHz to 40 MHz integration bandwidth		0.64		°rms
VCO_4					
Phase Noise, Locked	$f_{LO} = 1.57$ GHz				
	1 kHz offset		-90		dBc/Hz
	50 kHz offset		-109		dBc/Hz
	100 kHz offset		-119		dBc/Hz
	800 kHz offset		-144		dBc/Hz
	1 MHz offset		-145		dBc/Hz
	10 MHz offset		-156		dBc/Hz
	40 MHz offset		-156		dBc/Hz
Integrated Phase Noise	1 kHz to 40 MHz integration bandwidth		0.26		°rms
VCO_5					
Phase Noise, Locked	$f_{LO} = 1.68$ GHz				
	1 kHz offset		-93		dBc/Hz
	50 kHz offset		-107		dBc/Hz
	100 kHz offset		-118		dBc/Hz
	800 kHz offset		-144		dBc/Hz
	1 MHz offset		-145		dBc/Hz

Parameter	Test Conditions/Comments	Min	Typ	Max	Unit
Integrated Phase Noise	10 MHz offset		-157		dBc/Hz
	40 MHz offset		-157.5		dBc/Hz
	1 kHz to 40 MHz integration bandwidth		0.27		°rms

<sup>1</sup> The FOM is computed as phase noise (dBc/Hz) - 10log<sub>10</sub>(f<sub>FPD</sub>) - 20log<sub>10</sub>(f<sub>LO</sub>/f<sub>FPD</sub>). The FOM was measured across the full LO range, with f<sub>REF</sub> = 122.88 MHz and f<sub>REF</sub> power = 6.5 dBm with a 1.536 MHz f<sub>FPD</sub>. The FOM was computed at 50 kHz offset.

High performance mode, T<sub>A</sub> = 25°C, measured on LO output, f<sub>LO</sub> = 1700 MHz, Z<sub>O</sub> = 50 Ω, f<sub>REF</sub> = 122.88 MHz, f<sub>FPD</sub> = 30.72 MHz, f<sub>REF</sub> power = 4 dBm, CSCALE = 250 μA, bleed = 93.75 μA, ABLDLY = 0 ns, fractional mode loop filter, unless otherwise noted.

**Table 4. Fractional Mode**

Parameter	Test Conditions/Comments	Min	Typ	Max	Unit
SYNTHESIZER SPECIFICATIONS	Synthesizer specifications referenced to 1 × LO				
FOM <sup>1</sup>	P <sub>REFIN</sub> = 6.5 dBm		219		dBc/Hz/Hz
REFERENCE CHARACTERISTICS	REFIN, MUXOUT pins				
VCO_0					
Phase Noise, Locked	f <sub>LO</sub> = 2.55 GHz				
	1 kHz offset		-92.5		dBc/Hz
	50 kHz offset		-97.4		dBc/Hz
	100 kHz offset		-109.7		dBc/Hz
	1 MHz offset		-137.6		dBc/Hz
	10 MHz offset		-153.6		dBc/Hz
	40 MHz offset		-155.5		dBc/Hz
Integrated Phase Noise	1 kHz to 40 MHz integration bandwidth		0.36		°rms
VCO_1					
Phase Noise, Locked	f <sub>LO</sub> = 2.22 GHz				
	1 kHz offset		-93.6		dBc/Hz
	50 kHz offset		-101.8		dBc/Hz
	100 kHz offset		-112.5		dBc/Hz
	1 MHz offset		-140.5		dBc/Hz
	10 MHz offset		-154.3		dBc/Hz
	40 MHz offset		-155.3		dBc/Hz
Integrated Phase Noise	1 kHz to 40 MHz integration bandwidth		0.32		°rms
VCO_2					
Phase Noise, Locked	f <sub>LO</sub> = 1.9 GHz				
	1 kHz offset		-94.2		dBc/Hz
	50 kHz offset		-101.7		dBc/Hz
	100 kHz offset		-112.4		dBc/Hz
	1 MHz offset		-141.3		dBc/Hz
	10 MHz offset		-155.8		dBc/Hz
	40 MHz offset		-156.8		dBc/Hz
Integrated Phase Noise	1 kHz to 40 MHz integration bandwidth		0.32		°rms
VCO_3					
Phase Noise, Locked	f <sub>LO</sub> = 1.6 GHz				
	1 kHz offset		-93.1		dBc/Hz
	50 kHz offset		-99.8		dBc/Hz
	100 kHz offset		-110.9		dBc/Hz
	1 MHz offset		-140.2		dBc/Hz
	10 MHz offset		-155.7		dBc/Hz
	40 MHz offset		-157.2		dBc/Hz
Integrated Phase Noise	1 kHz to 40 MHz integration bandwidth		0.33		°rms

<sup>1</sup> The FOM is computed as phase noise (dBc/Hz) - 10log<sub>10</sub>(f<sub>FPD</sub>) - 20log<sub>10</sub>(f<sub>LO</sub>/f<sub>FPD</sub>). The FOM was measured across the full LO range, with f<sub>REF</sub> = 122.88 MHz and f<sub>REF</sub> power = 6.5 dBm with a 30.72 MHz f<sub>FPD</sub>. The FOM was computed at 45 kHz offset.

**VCO SPECIFICATIONS, OPEN-LOOP**High performance mode,  $T_A = 25^\circ\text{C}$ , measured on LO output, unless otherwise noted.

Table 5.

Parameter	Test Conditions/Comments	Min	Typ	Max	Unit
VCO_0 PHASE NOISE	$f_{LO} = 2.55\text{ GHz}$				
	1 kHz offset		-50		dBc/Hz
	50 kHz offset		-104.4		dBc/Hz
	100 kHz offset		-112.6		dBc/Hz
	1 MHz offset		-137.7		dBc/Hz
	10 MHz offset		-154		dBc/Hz
	40 MHz offset		-155.1		dBc/Hz
VCO_1 PHASE NOISE	$f_{LO} = 2.15\text{ GHz}$				
	1 kHz offset		-54		dBc/Hz
	50 kHz offset		-106.1		dBc/Hz
	100 kHz offset		-115		dBc/Hz
	1 MHz offset		-138.9		dBc/Hz
	10 MHz offset		-155.8		dBc/Hz
	40 MHz offset		-155.2		dBc/Hz
VCO_2 PHASE NOISE	$f_{LO} = 1.9\text{ GHz}$				
	1 kHz offset		-53.6		dBc/Hz
	50 kHz offset		-106.6		dBc/Hz
	100 kHz offset		-114.6		dBc/Hz
	1 MHz offset		-140.8		dBc/Hz
	10 MHz offset		-155.4		dBc/Hz
	40 MHz offset		-156.3		dBc/Hz
VCO_3 PHASE NOISE	$f_{LO} = 1.6\text{ GHz}$				
	1 kHz offset		-48.5		dBc/Hz
	50 kHz offset		-106		dBc/Hz
	100 kHz offset		-115.3		dBc/Hz
	800 kHz offset		-139.2		dBc/Hz
	1 MHz offset		-140.2		dBc/Hz
	10 MHz offset		-157.7		dBc/Hz
	40 MHz offset		-156.3		dBc/Hz
VCO_4 PHASE NOISE	$f_{VCO} = 3.14\text{ GHz}$				
	1 kHz offset		-53.8		dBc/Hz
	50 kHz offset		-110.3		dBc/Hz
	100 kHz offset		-118		dBc/Hz
	800 kHz offset		-139.5		dBc/Hz
	1 MHz offset		-140.6		dBc/Hz
	10 MHz offset		-155.4		dBc/Hz
	40 MHz offset		-157.4		dBc/Hz
VCO_5 PHASE NOISE	$f_{VCO} = 3.36\text{ GHz}$				
	1 kHz offset		-54		dBc/Hz
	50 kHz offset		-108.3		dBc/Hz
	100 kHz offset		-116.3		dBc/Hz
	800 kHz offset		-138.5		dBc/Hz
	1 MHz offset		-140		dBc/Hz
	10 MHz offset		-156.3		dBc/Hz
	40 MHz offset		-157.8		dBc/Hz

## LOGIC INPUT/OUTPUT AND POWER SPECIFICATIONS

$T_A = 25^\circ\text{C}$ ,  $f_{RF} = 1900\text{ MHz}$ ,  $f_{LO} = 1697\text{ MHz}$ ,  $Z_O = 50\ \Omega$ ,  $f_{REF} = 122.88\text{ MHz}$ ,  $f_{REF}\text{ power} = 4\text{ dBm}$ ,  $f_{PPD} = 1.536\text{ MHz}$ , low-side LO injection, optimum RFB and LPF settings, unless otherwise noted.

Table 6.

Parameter	Test Conditions/Comments	Min	Typ	Max	Unit
LOGIC INPUT/OUTPUTS					
SCLK, SDIO, $\overline{\text{CS}}$					
Input Voltage					
High, $V_{IH}$		1.4		3.3	V
Low, $V_{IL}$		0		0.7	V
Output Voltage					
High, $V_{OH}$	$I_{OH} = -100\ \mu\text{A}$	2.3			V
Low, $V_{OL}$	$I_{OL} = 100\ \mu\text{A}$			0.2	V
Input Current, $I_{INH}/I_{INL}$			0.1		$\mu\text{A}$
POWER SUPPLIES					
High Performance Mode					
Voltage Range					
VCC1, VCC2, VCC7, VCC12		3.55	3.7	5.25	V
VCC3, VCC4, VCC5, VCC6, VCC8, VCC9, VCC10, VCC11, IFOUT1+, IFOUT1-, IFOUT2+, IFOUT2-		4.75	5	5.25	V
Power Dissipation					
	Internal LO mode (internal PLL)				
	External LO output enabled		2.7		W
	External LO output disabled		2.5		W
High Efficiency Mode					
Voltage Range					
VCC1, VCC2, VCC3, VCC4, VCC5, VCC6, VCC7, VCC8, VCC9, VCC10, VCC11, VCC12, IFOUT1+, IFOUT1-, IFOUT2+, IFOUT2-		3.55	3.7	3.85	V
Power Dissipation					
	Internal LO mode (internal PLL)				
	External LO output enabled		2.0		W
	External LO output disabled		1.8		W



DIGITAL LOGIC SPECIFICATIONS

Table 7.

Symbol	Description	Min	Typ	Max	Unit
$t_{CLK}$	Serial clock period	38			ns
$t_{DS}$	Setup time between data and rising edge of SCLK	8			ns
$t_{DH}$	Hold time between data and rising edge of SCLK	8			ns
$t_S$	Setup time between falling edge of $\overline{CS}$ and SCLK	10			ns
$t_H$	Hold time between rising edge of $\overline{CS}$ and SCLK	10			ns
$t_{HIGH}$	Minimum period for SCLK to be in a logic high state	10			ns
$t_{LOW}$	Minimum period for SCLK to be in a logic low state	10			ns
$t_{ACCESS}$	Maximum delay between falling edge of SCLK and output data Valid for a read operation			231	ns
$t_z$	Maximum delay between $\overline{CS}$ deactivation and SDIO bus return to high impedance			5	ns

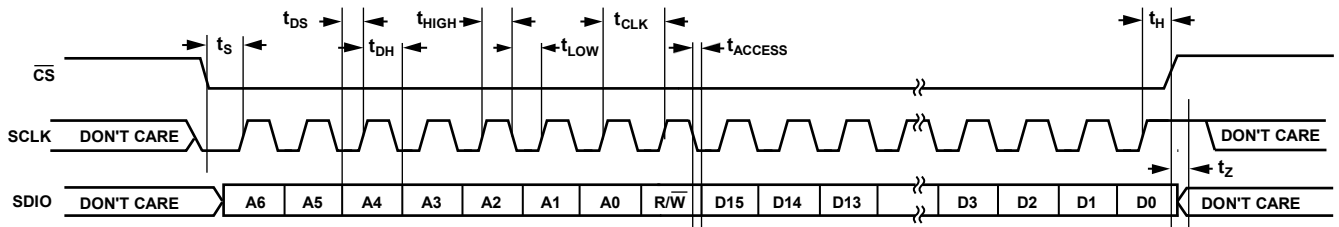

Figure 2. Setup and Hold Timing Measurements

14115-002

## ABSOLUTE MAXIMUM RATINGS

Table 8.

Parameter	Rating
Supply Voltage (VCC1, VCC2, VCC3, VCC4, VCC5, VCC6, VCC7, VCC8, VCC9, VCC10, VCC11, VCC12, IFOUT1+, IFOUT1-, IFOUT2+, IFOUT2-)	-0.5 V to +5.5 V
Digital Input/Output (SCLK, SDIO, $\overline{CS}$ )	-0.3 V to +3.6 V
RFINx	20 dBm
EXTVCOIN+, EXTVCOIN-	13 dBm
Maximum Junction Temperature	150°C
Operating Temperature Range	-40°C to +85°C
Storage Temperature Range	-65°C to +150°C

Stresses at or above those listed under Absolute Maximum Ratings may cause permanent damage to the product. This is a stress rating only; functional operation of the product at these or any other conditions above those indicated in the operational section of this specification is not implied. Operation beyond the maximum operating conditions for extended periods may affect product reliability.

## THERMAL RESISTANCE

$\theta_{JC}$  is specified for the worst case conditions, that is, a device soldered in a circuit board for surface-mount packages.

Table 9. Thermal Resistance

Package Type	$\theta_{JC}$	Unit
48-Lead LFCSP	1.62	°C/W

## ESD CAUTION



**ESD (electrostatic discharge) sensitive device.** Charged devices and circuit boards can discharge without detection. Although this product features patented or proprietary protection circuitry, damage may occur on devices subjected to high energy ESD. Therefore, proper ESD precautions should be taken to avoid performance degradation or loss of functionality.

## PIN CONFIGURATION AND FUNCTION DESCRIPTIONS

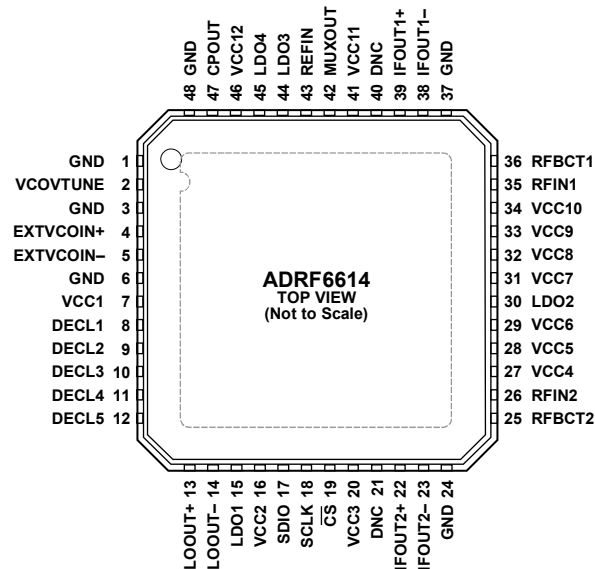

- NOTES
1. DNC = DO NOT CONNECT.
  2. THE EXPOSED PAD MUST BE CONNECTED TO A GROUND PLANE WITH LOW THERMAL IMPEDANCE.

14115-003

Figure 3. Pin Configuration

Table 10. Pin Function Descriptions

Pin No.	Mnemonic	Description
1	GND	Common Ground Connection for External Loop Filter.
2	VCOVTUNE	Control Voltage for Internal VCO.
3, 6	GND	Common Ground for External VCO.
4, 5	EXTVCOIN+, EXTVCOIN-	Inputs from External VCO to Internal Divider.
7	VCC1	3.7 V VCO Supply.
8, 9	DECL1, DECL2	LDO Output Decouplers for VCO.
10, 11	DECL3, DECL4	External Decouplers for VCO Buffer.
12	DECL5	External Decoupler for VCO Circuitry.
13, 14	LOOUT+, LOOUT-	Differential Outputs of Internally Generated LO.
15	LDO1	External Decoupling for Internal 2.5 V SPI Port LDO.
16	VCC2	3.7 V Supply for Programmable SPI Port.
17	SDIO	Serial Data Input/Output for Programmable SPI Port.
18	SCLK	Clock for Programmable SPI Port.
19	$\overline{CS}$	SPI Chip Select, Active Low.
20, 41	VCC3, VCC11	5 V Biases for Channel 1 and Channel 2 IF.
21, 40	DNC	Do Not Connect. Do not connect these pins externally.
22, 23	IFOUT2+, IFOUT2-	Channel 2 Differential IF Outputs.
24, 37	GND	Ground Connections for Channel 1 and Channel 2 IF Stage.
25	RFBCT2	Balun Center Tap Connection for Channel 2 RF Input.
26	RFIN2	Channel 2 RF Input.
27, 28, 29	VCC4, VCC5, VCC6	5 V Supplies for Mixer LO Amplifiers.
30	LDO2	External Decoupling for Internal 3.3 V PLL/Divider LDO.
31	VCC7	3.7 V Supply for Mixer LO Divider Chain.
32, 33, 34	VCC8, VCC9, VCC10	5 V Supplies for Mixer LO Amplifiers.
35	RFIN1	Channel 1 RF Input.
36	RFBCT1	Balun Center Tap Connection for Channel 1 RF Input.
38, 39	IFOUT1-, IFOUT1+	Channel 1 Differential IF Outputs.
42	MUXOUT	Internal Multiplexer Output.

Pin No.	Mnemonic	Description
43	REFIN	Reference Input for Internal PLL (Single-Ended, CMOS).
44	LDO3	External Decoupling for Internal 2.5 V PLL LDO.
45	LDO4	External Decoupling for Internal 3.3 V PLL LDO.
46	VCC12	3.7 V Supply for Internal PLL.
47	CPOUT	Charge Pump Output.
48	GND	Common Ground for External Charge Pump.
	EPAD	Exposed Pad. The exposed pad must be connected to a ground plane with low thermal impedance.

# TYPICAL PERFORMANCE CHARACTERISTICS

## MIXER, HIGH PERFORMANCE MODE

$T_A = 25^\circ\text{C}$ ,  $f_{RF} = 1900\text{ MHz}$ ,  $f_{LO} = 1697\text{ MHz}$ ,  $Z_O = 50\ \Omega$ ,  $f_{REF} = 122.88\text{ MHz}$ ,  $f_{REF}\text{ power} = 4\text{ dBm}$ , low-side LO injection, optimum RFB and LPF settings, unless otherwise noted. For integer mode:  $f_{FPD} = 1.536\text{ MHz}$ ,  $CSCALE = 8\text{ mA}$ ,  $bleed = 0\ \mu\text{A}$ ,  $ABLDLY = 0.9\text{ ns}$ . For fractional mode:  $f_{FPD} = 30.72\text{ MHz}$ ,  $CSCALE = 250\ \mu\text{A}$ ,  $bleed = 93.75\ \mu\text{A}$ ,  $ABLDLY = 0.0\text{ ns}$ .

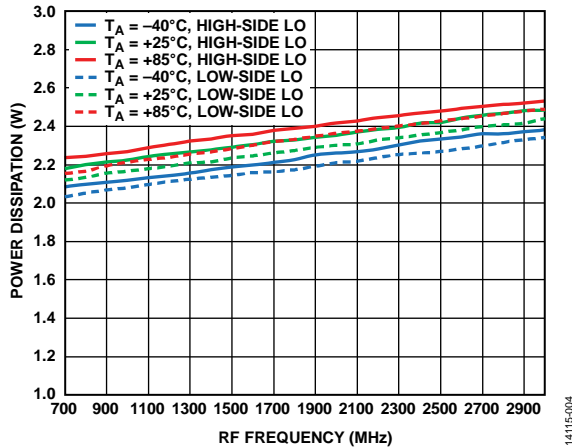

Figure 4. Power Dissipation vs. RF Frequency over Three Temperatures

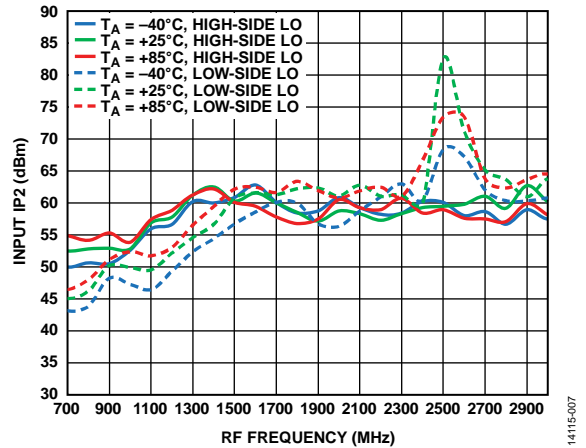

Figure 7. Input IP2 vs. RF Frequency over Three Temperatures

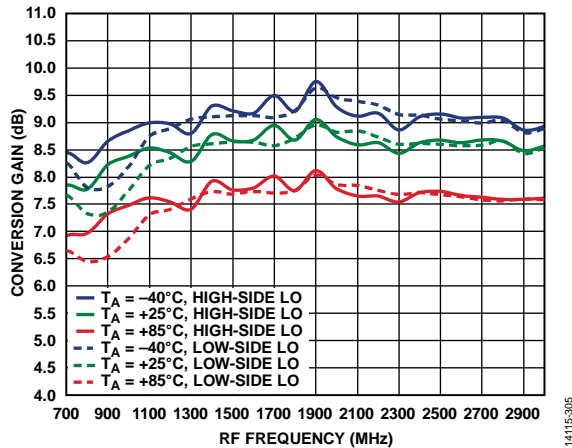

Figure 5. Power Conversion Gain vs. RF Frequency over Three Temperatures, IF Balun and Board Loss Removed

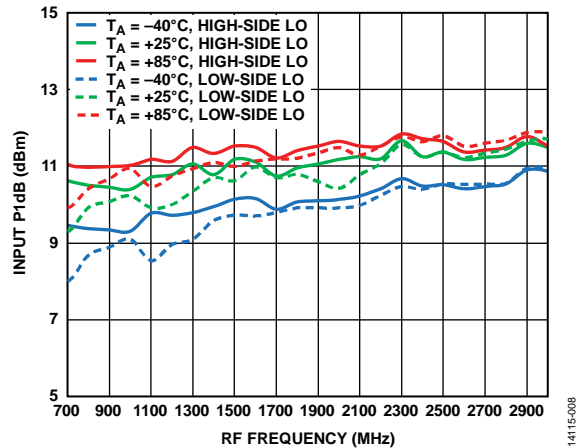

Figure 8. Input P1dB vs. RF Frequency over Three Temperatures

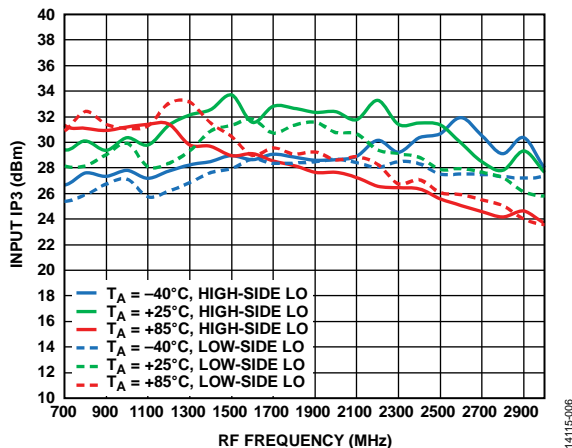

Figure 6. Input IP3 vs. RF Frequency over Three Temperatures

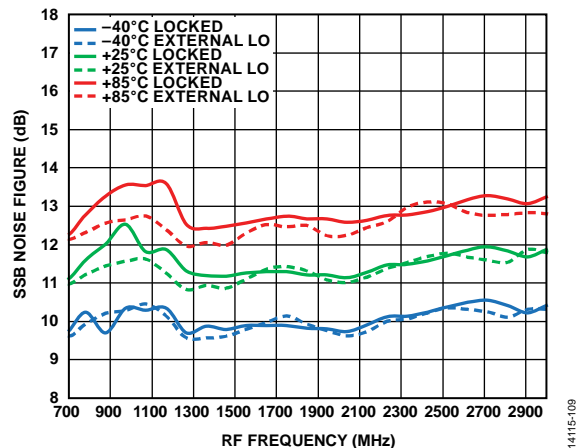

Figure 9. SSB Noise Figure vs. RF Frequency over Three Temperatures

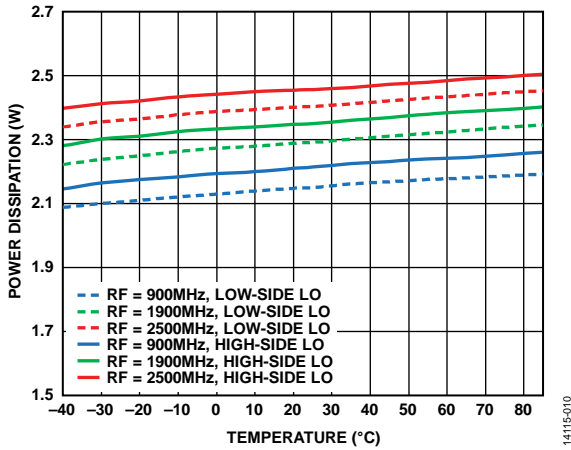

Figure 10. Power Dissipation vs. Temperature for Three RF Frequencies

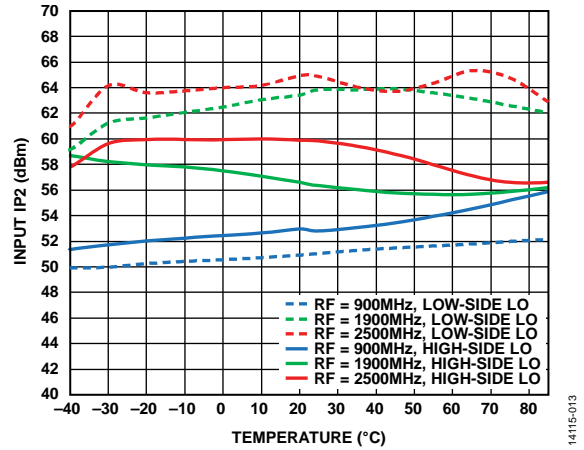

Figure 13. Input IP2 vs. Temperature for Three RF Frequencies

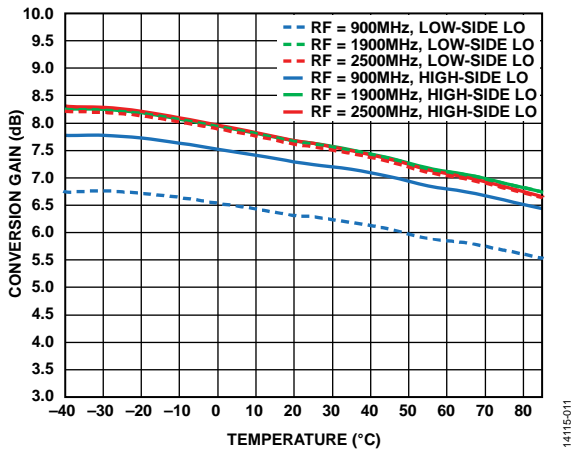

Figure 11. Power Conversion Gain vs. Temperature for Three RF Frequencies

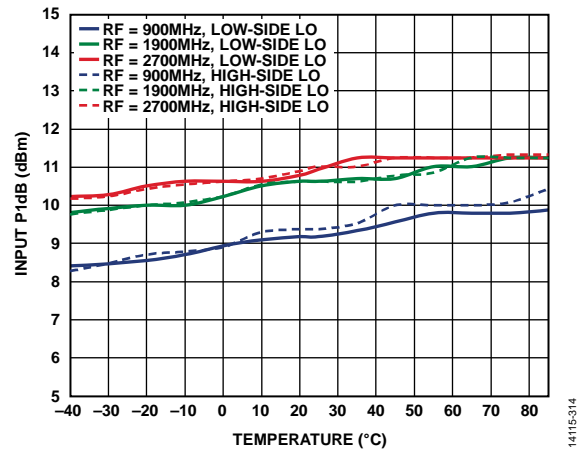

Figure 14. Input P1dB vs. Temperature for Three RF Frequencies

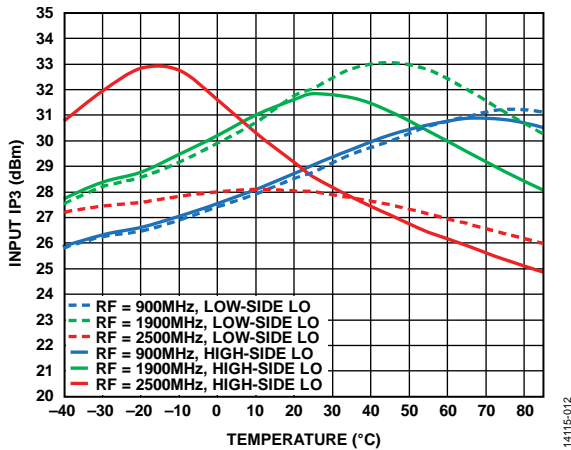

Figure 12. Input IP3 vs. Temperature for Three RF Frequencies

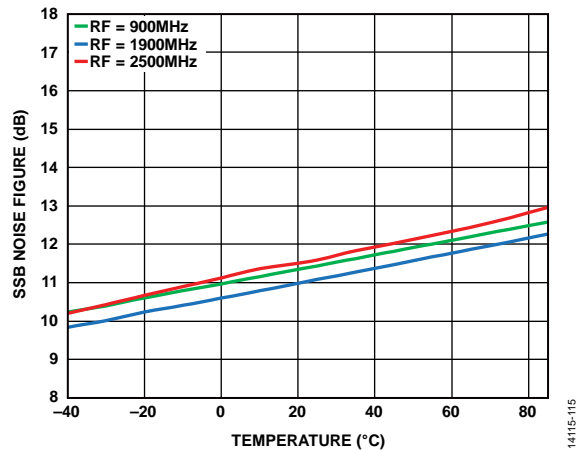

Figure 15. SSB Noise Figure vs. Temperature for Three RF Frequencies

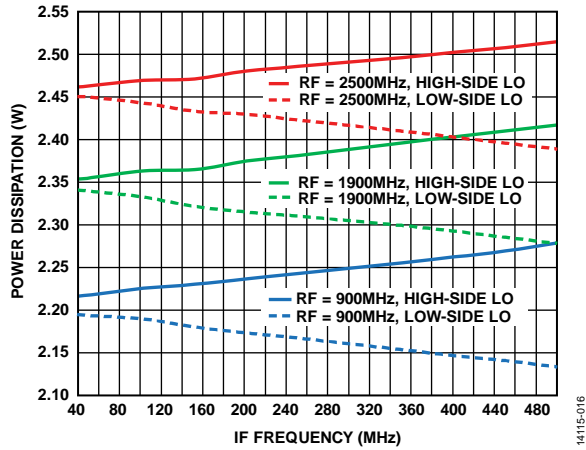

Figure 16. Power Dissipation vs. IF Frequency for Three RF Frequencies

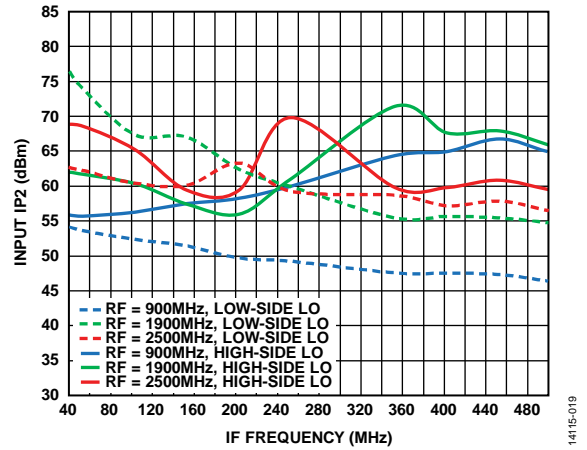

Figure 19. Input IP2 vs. IF Frequency for Three RF Frequencies

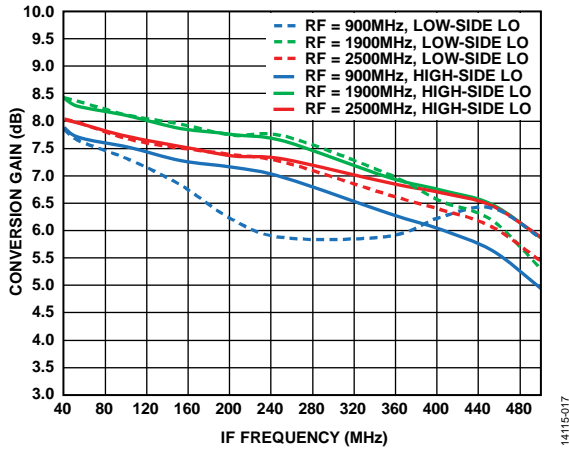

Figure 17. Power Conversion Gain vs. IF Frequency for Three RF Frequencies

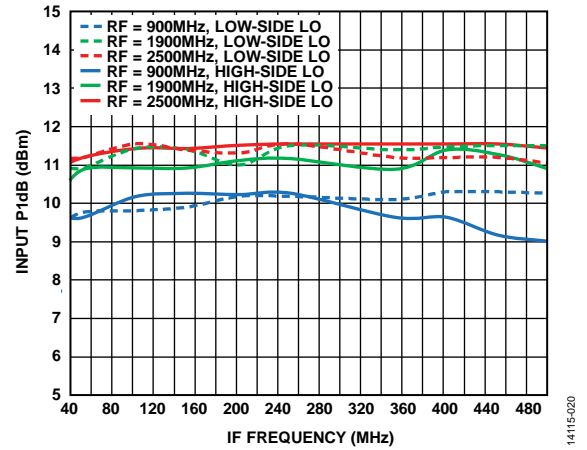

Figure 20. Input P1dB vs. IF Frequency for Three RF Frequencies

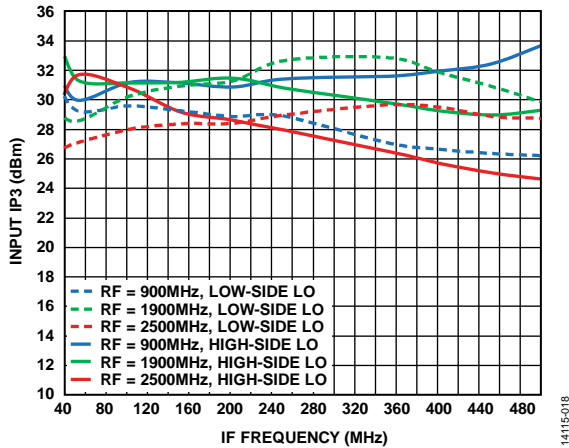

Figure 18. Input IP3 vs. IF Frequency for Three RF Frequencies

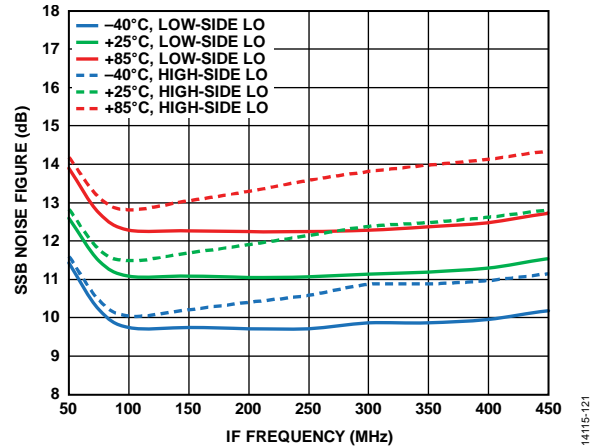

Figure 21. SSB Noise Figure vs. IF Frequency for Three Temperatures

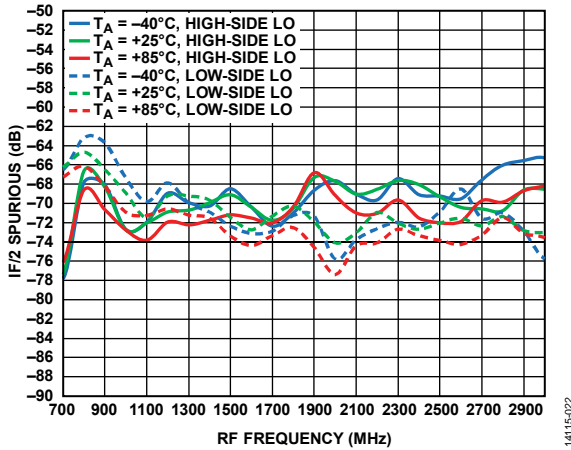

Figure 22. IF/2 Spurious vs. RF Frequency over Three Temperatures

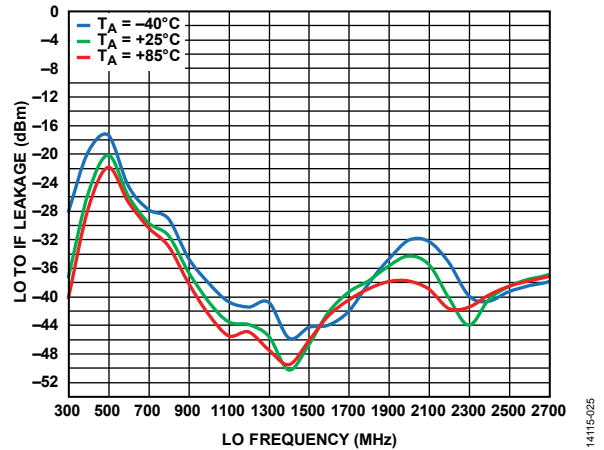

Figure 25. LO to IF Leakage vs. LO Frequency over Three Temperatures

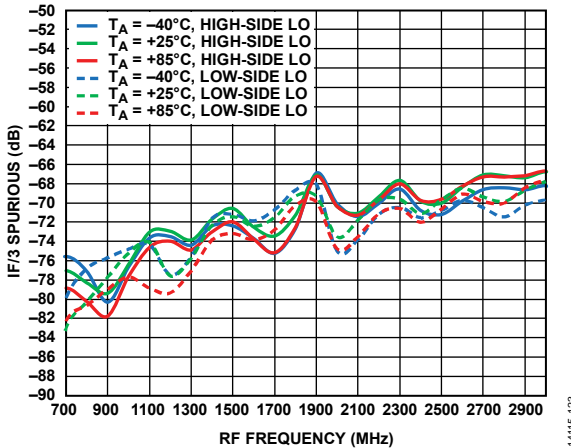

Figure 23. IF/3 Spurious vs. RF Frequency over Three Temperatures

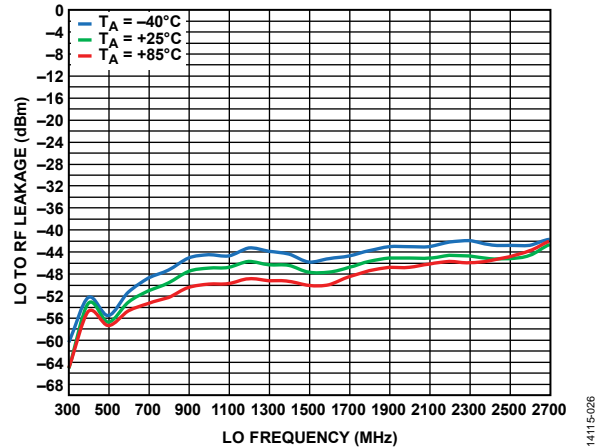

Figure 26. LO to RF Leakage vs. LO Frequency over Three Temperatures

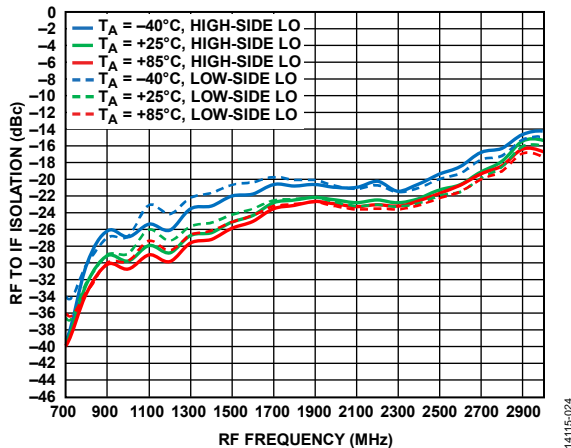

Figure 24. RF to IF Isolation vs. RF Frequency over Three Temperatures

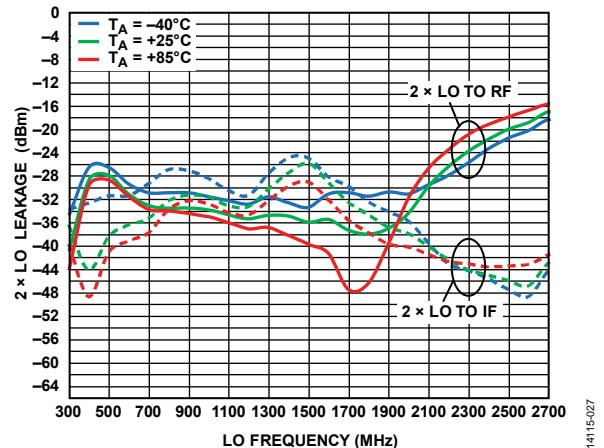

Figure 27. 2 x LO Leakage vs. LO Frequency over Three Temperatures (2 x LO to RF and 2 x LO to IF)



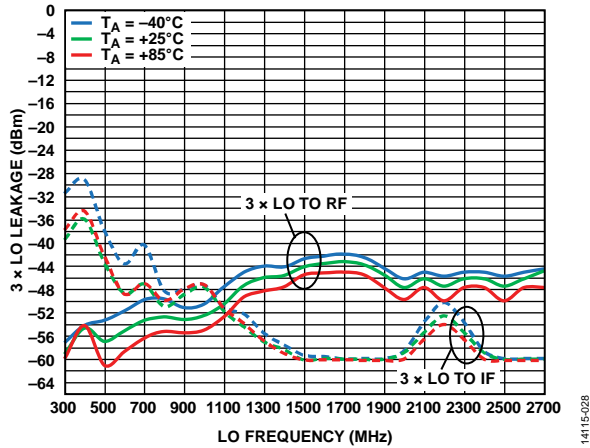

Figure 28. 3 x LO Leakage vs. LO Frequency over Three Temperatures (3 x LO to RF and 3 x LO to IF)

14115-028

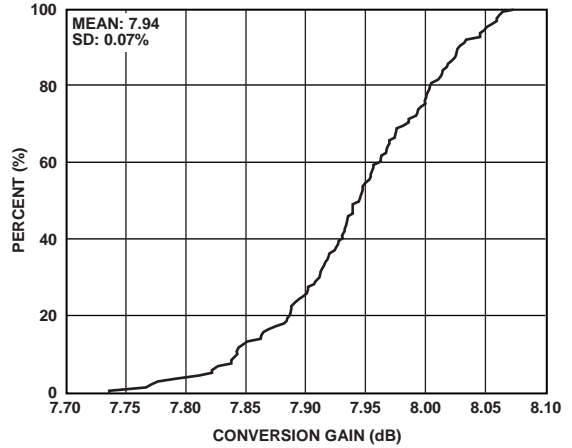

Figure 31. Conversion Gain Distribution

14115-131

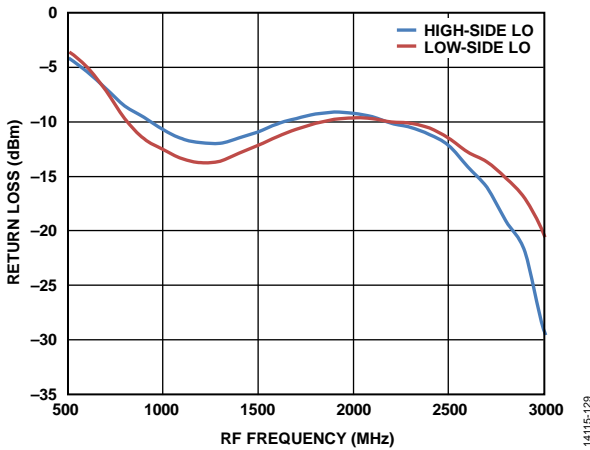

Figure 29. RF Port Return Loss, Fixed IF LO Return Loss

14115-129

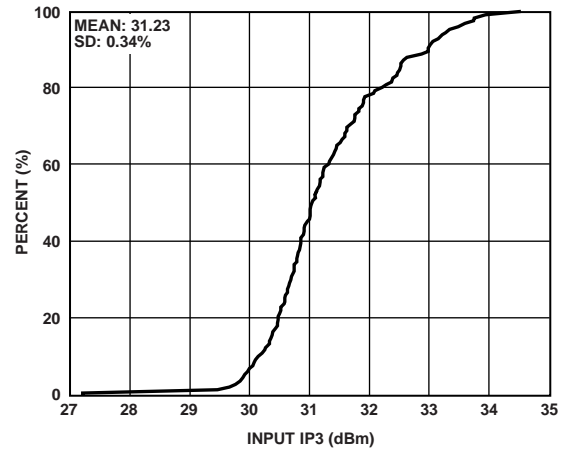

Figure 32. Input IP3 Distribution

14115-132

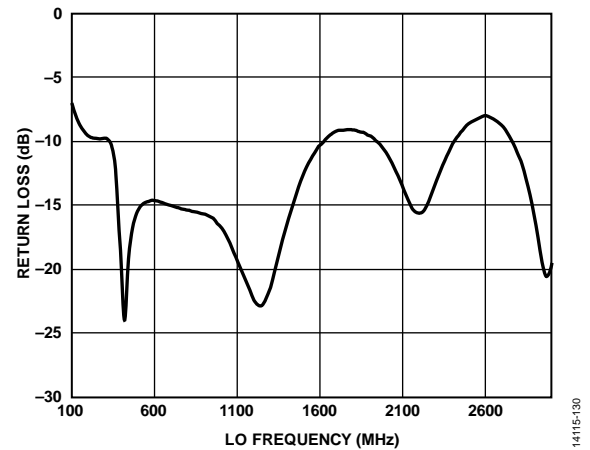

Figure 30. LO Return Loss

14115-130

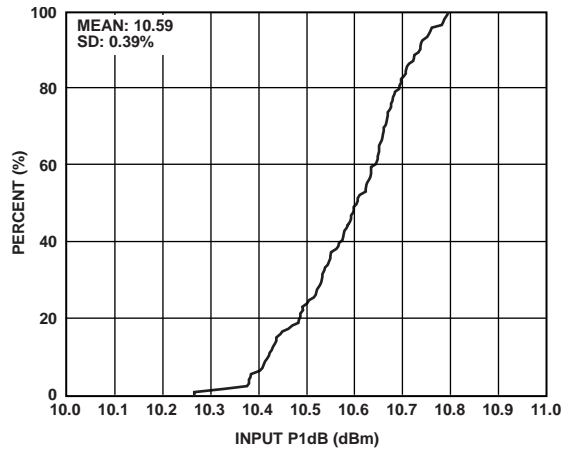

Figure 33. Input P1dB Distribution

14115-133

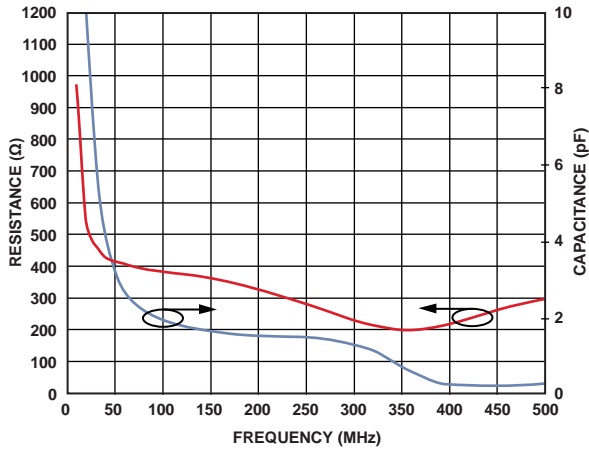

Figure 34. IF Output Impedance (R Parallel C Equivalent)

14115-334

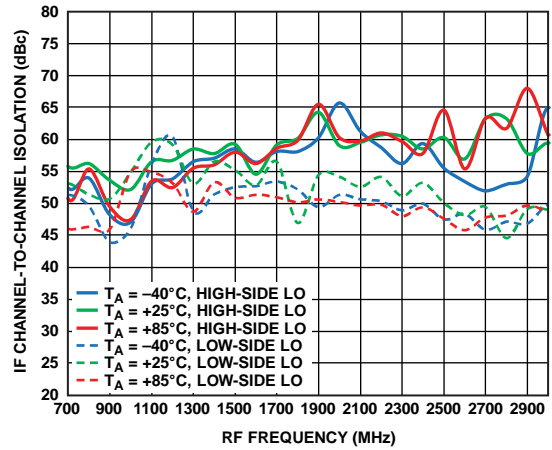

Figure 37. IF Channel to Channel Isolation vs. RF Frequency over Three Temperatures

14115-337

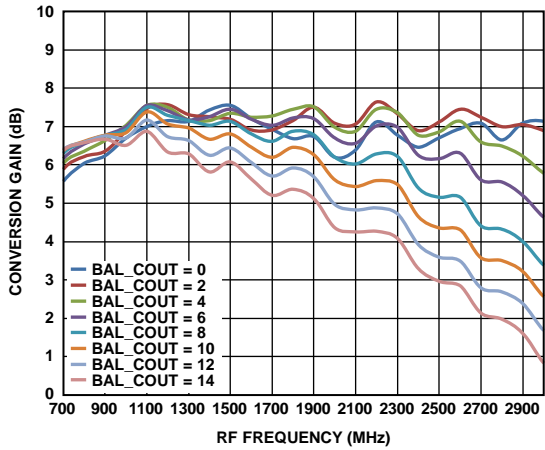

Figure 35. Conversion Gain vs. RF Frequency for All RFB Settings, VGS Bit and LPF Use Optimum Settings

14115-035

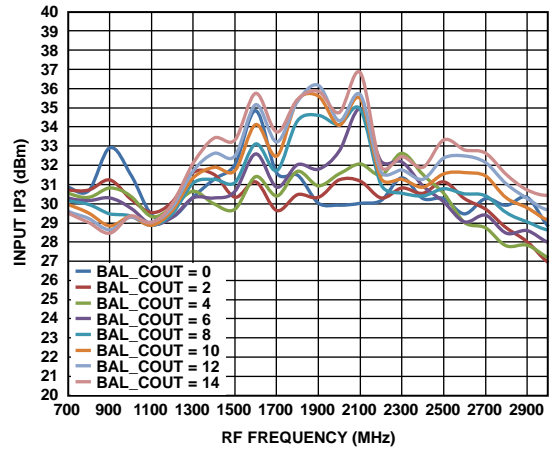

Figure 38. Input IP3 vs. RF Frequency for All RFB Settings, VGS Bit and LPF Use Optimum Settings

14115-038

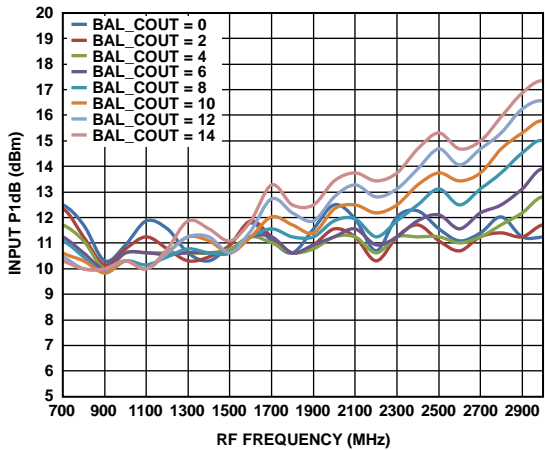

Figure 36. Input P1dB vs. RF Frequency for All RFB Settings, VGS Bit and LPF Use Optimum Settings

14115-036

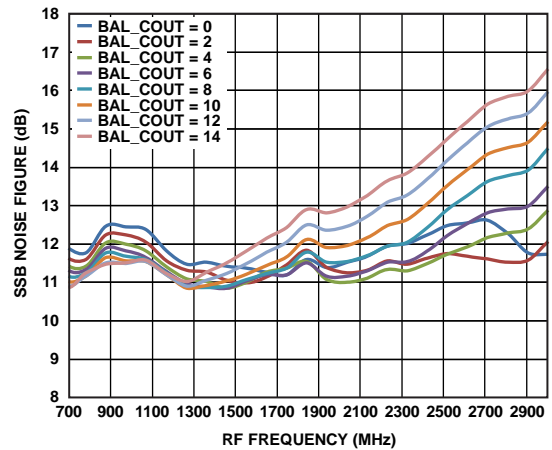

Figure 39. SSB Noise Figure vs. RF Frequency for All RFB Settings, VGS Bit and LPF Use Optimum Settings

14115-139

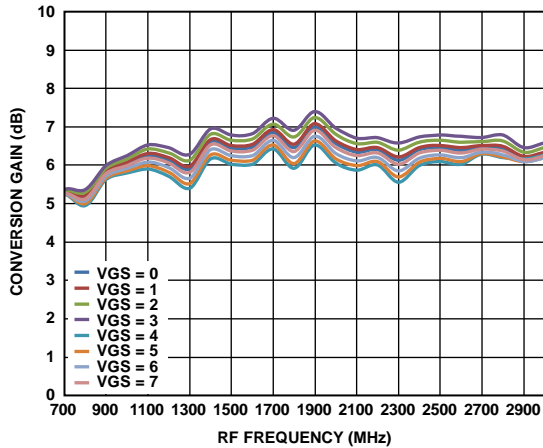

Figure 40. Conversion Gain vs. RF Frequency for All VGS Bit Settings, RFB and LPF Use Optimum Settings

14115-040

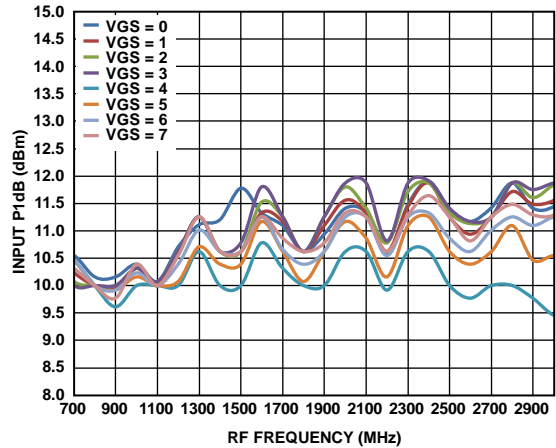

Figure 43. Input P1dB vs. RF Frequency for All VGS Bit Settings, RFB and LPF Use Optimum Settings

14115-043

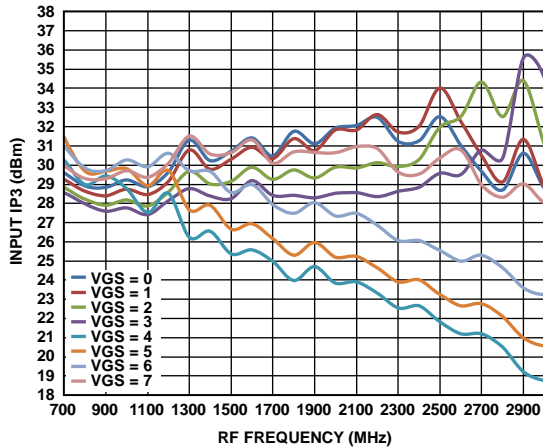

Figure 41. Input IP3 vs. RF Frequency for All VGS Bit Settings, RFB and LPF Use Optimum Settings

14115-141

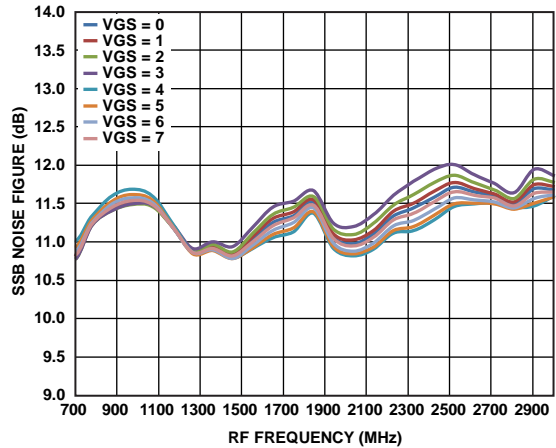

Figure 44. SSB Noise Figure vs. RF Frequency for All VGS Bit Settings, RFB and LPF Use Optimum Settings

14115-144

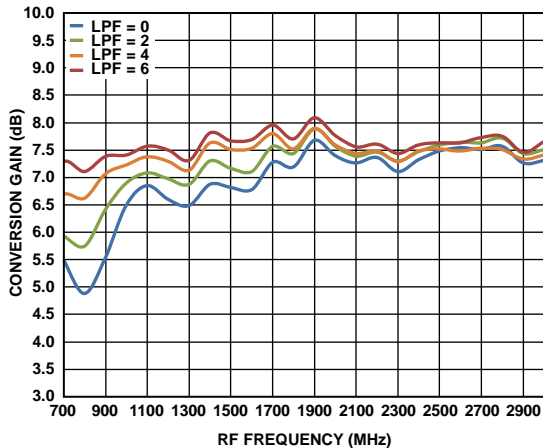

Figure 42. Conversion Gain vs. RF Frequency for All LPF Settings, RFB and VGS Bit Use Optimum Settings

14115-146

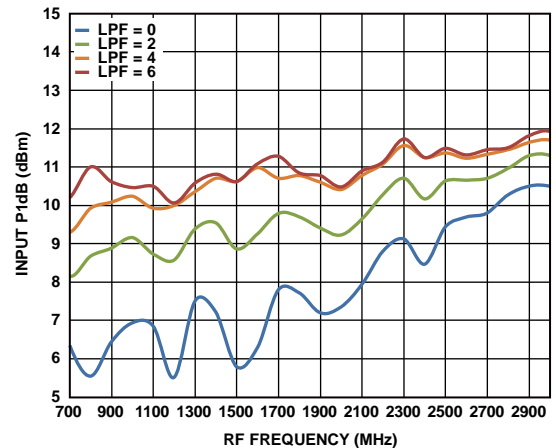

Figure 45. Input P1dB vs. RF Frequency for All LPF Settings, RFB and VGS Bit Use Optimum Settings

14115-148

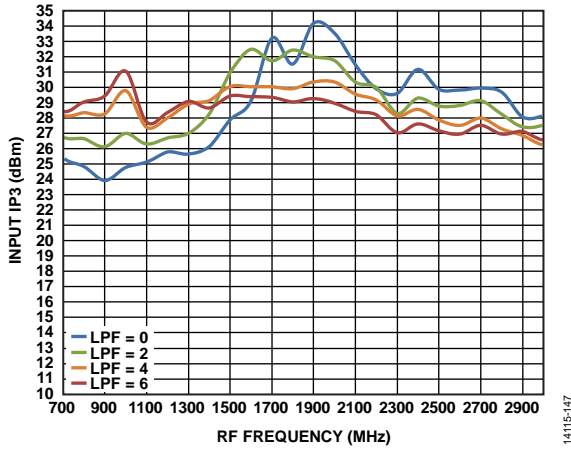

Figure 46. Input IP3 vs. RF Frequency for All LPF Settings, RFB and VGS Bit Use Optimum Settings

14115-147

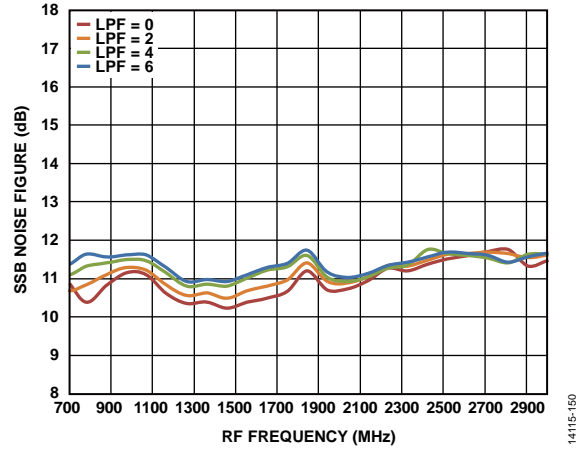

Figure 49. SSB Noise Figure vs. RF Frequency for All LPF Settings, RFB and VGS Bit Use Optimum Settings

14115-150

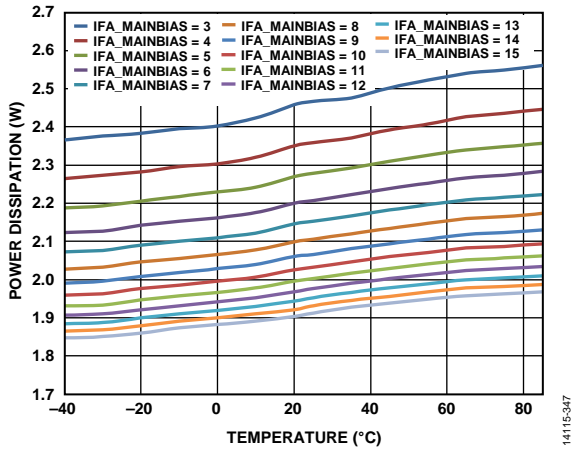

Figure 47. Power Dissipation vs. Temperature for Various IFA\_MAINBIAS Settings

14115-347

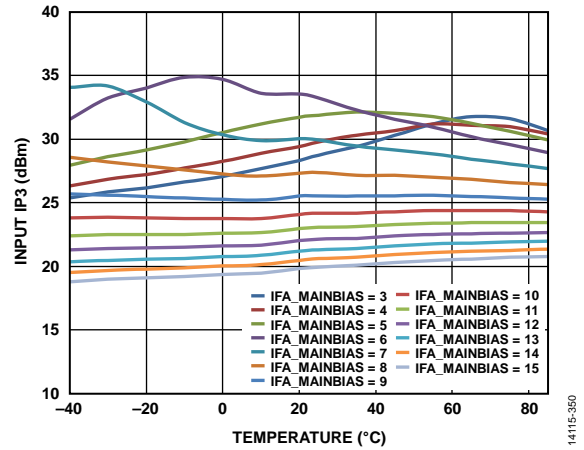

Figure 50. Input IP3 vs. Temperature for Various IFA\_MAINBIAS Settings

14115-350

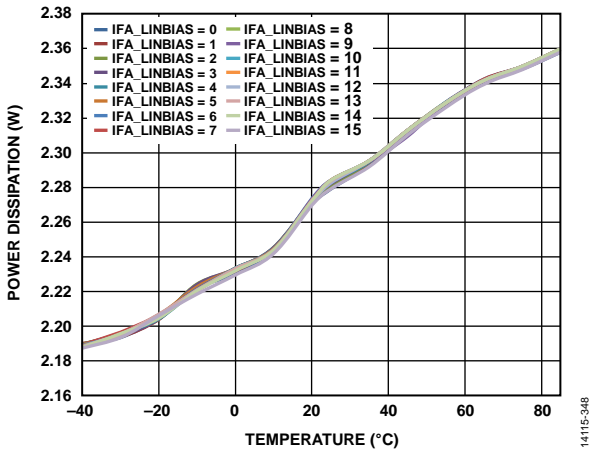

Figure 48. Power Dissipation vs. Temperature for Various IFA\_LINBIAS Settings

14115-348

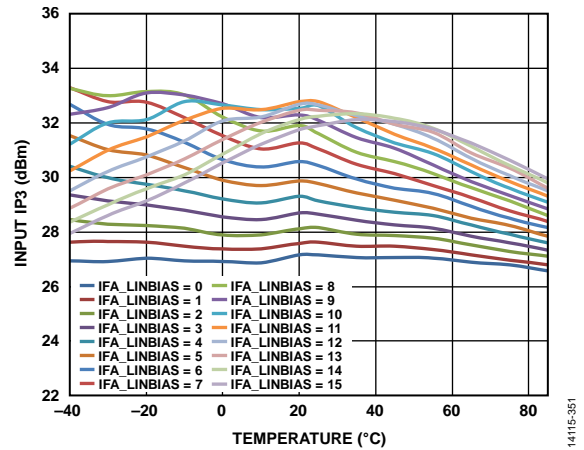

Figure 51. Input IP3 vs. Temperature for Various IFA\_LINBIAS Settings

14115-351

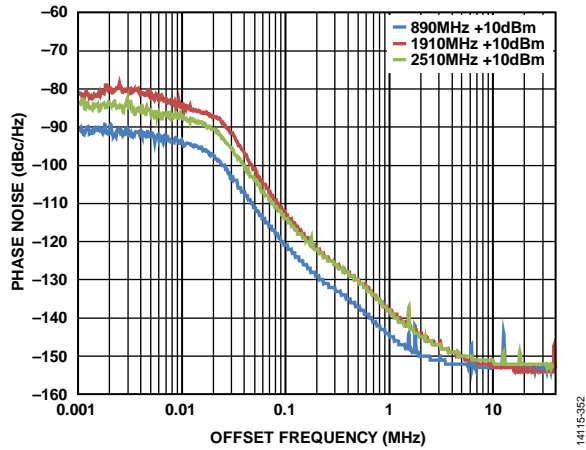

Figure 52. Phase Noise at IF Output vs. Offset Frequency with 10 dBm Blocker in Integer Mode

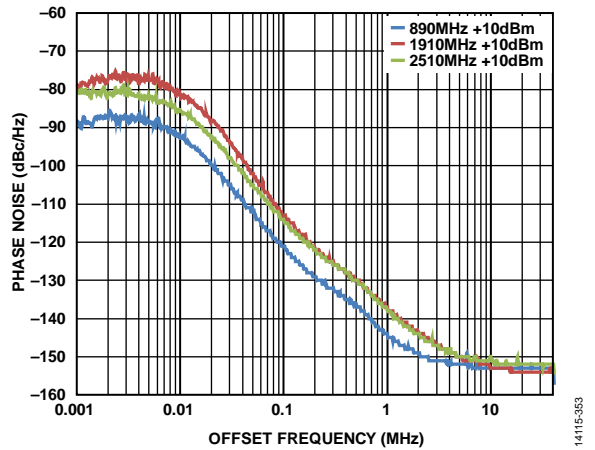

Figure 53. Phase Noise at IF Output vs. Offset Frequency with 10 dBm Blocker in Fractional Mode

MIXER, HIGH EFFICIENCY MODE

$T_A = 25^\circ\text{C}$ ,  $f_{RF} = 1900\text{ MHz}$ ,  $f_{LO} = 1697\text{ MHz}$ ,  $Z_O = 50\ \Omega$ ,  $f_{REF} = 122.88\text{ MHz}$ ,  $f_{REF}\text{ power} = 4\text{ dBm}$ ,  $f_{PPD} = 1.536\text{ MHz}$ , low-side LO injection, optimum RFB and LPF settings, unless otherwise noted.

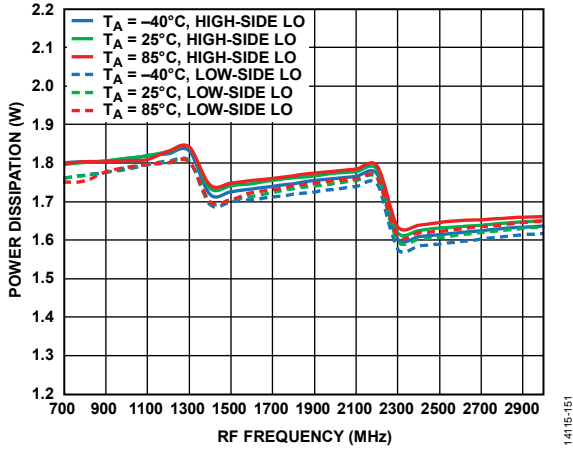

Figure 54. Power Dissipation vs. RF Frequency over Three Temperatures

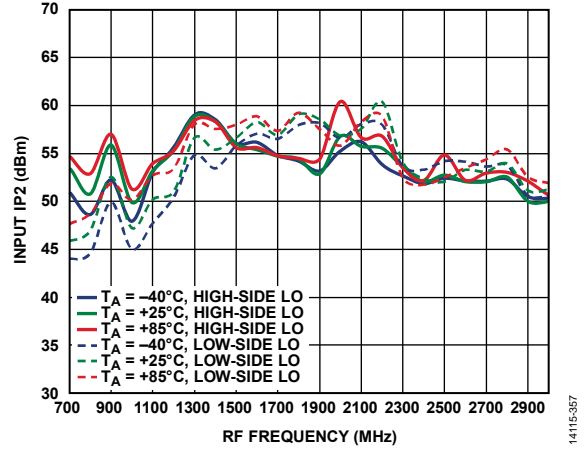

Figure 57. Input IP2 vs. RF Frequency over Three Temperatures

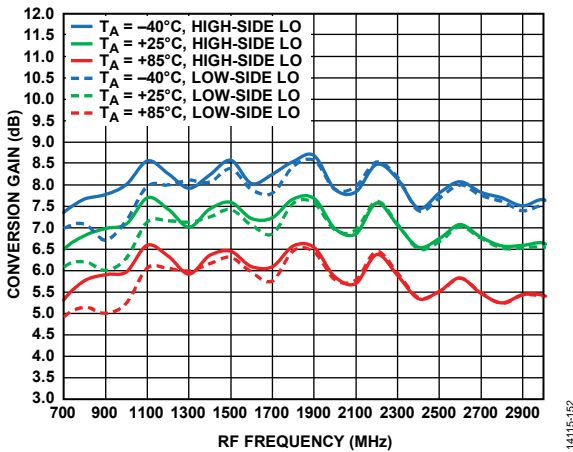

Figure 55. Conversion Gain vs. RF Frequency over Three Temperatures

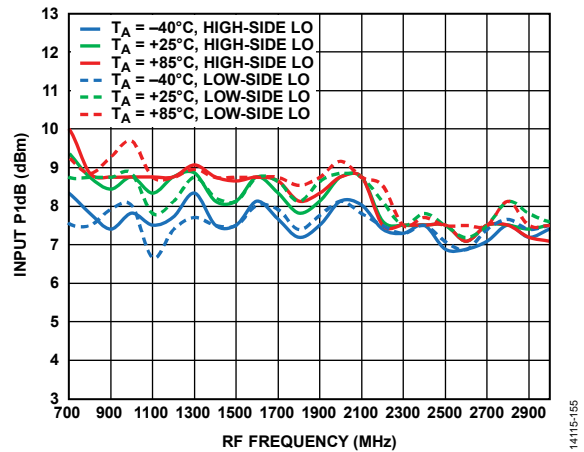

Figure 58. Input P1dB vs. RF Frequency over Three Temperatures

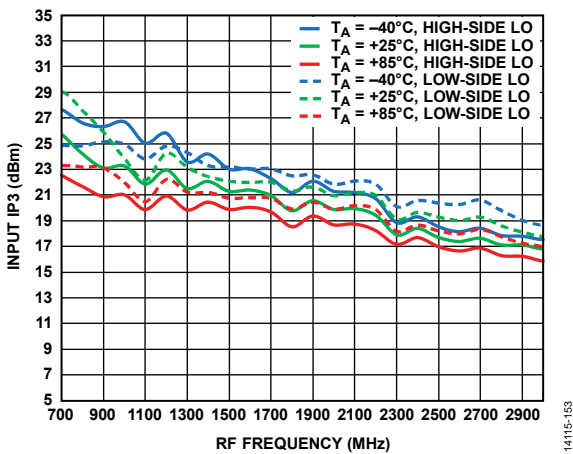

Figure 56. Input IP3 vs. RF Frequency over Three Temperatures

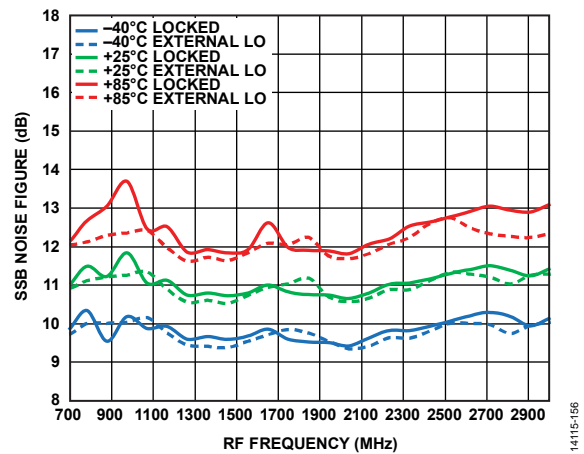

Figure 59. SSB Noise Figure vs. RF Frequency over Three Temperatures

**SYNTHESIZER**

$V_S$  = high performance mode,  $T_A = 25^\circ\text{C}$ , measured on LO output,  $f_{LO} = 1700\text{ MHz}$ ,  $Z_O = 50\ \Omega$ ,  $f_{REF} = 122.88\text{ MHz}$ ,  $f_{PPFD} = 1.536\text{ MHz}$ ,  $f_{REF}$  power = 4 dBm, integer mode loop filter, unless otherwise noted.

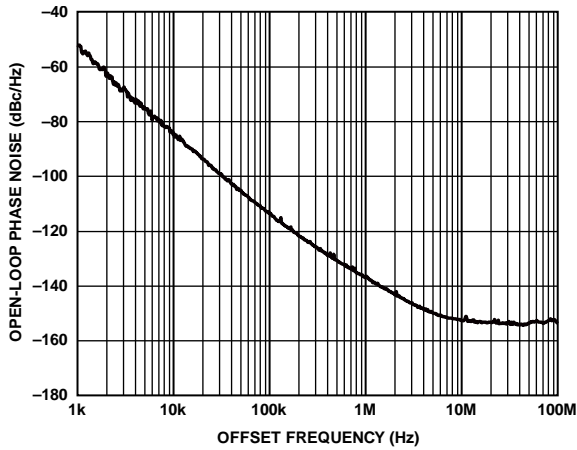

Figure 60. VCO\_0 Open-Loop Phase Noise vs. Offset Frequency,  $f_{VCO_0} = 2.55\text{ GHz}$ , Divide by Two Selected, VCOVTUNE = 1.5 V

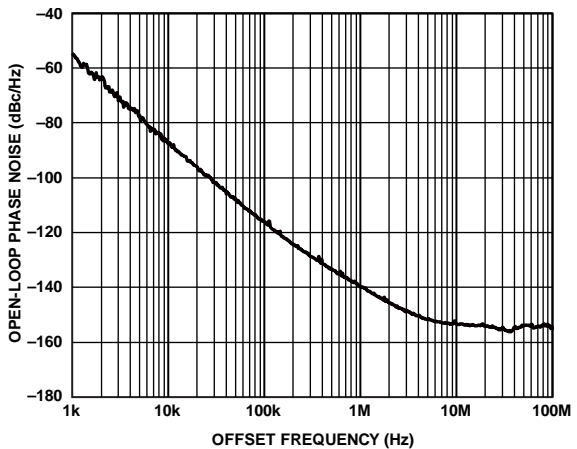

Figure 61. VCO\_1 Open-Loop Phase Noise vs. Offset Frequency,  $f_{VCO_1} = 2.2\text{ GHz}$ , Divide by Two Selected, VCOVTUNE = 1.5 V

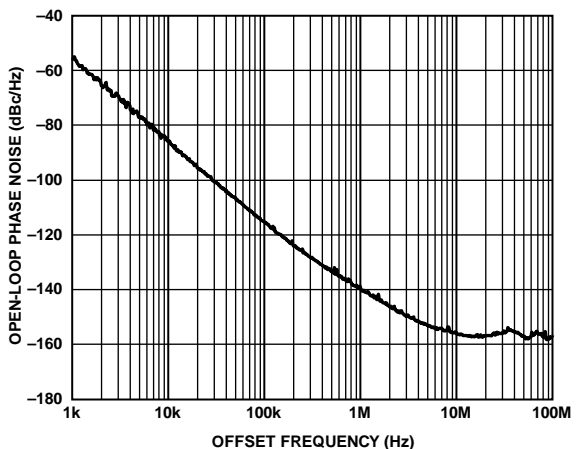

Figure 62. VCO\_2 Open-Loop Phase Noise vs. Offset Frequency,  $f_{VCO_2} = 1.9\text{ GHz}$ , Divide by Two Selected, VCOVTUNE = 1.5 V

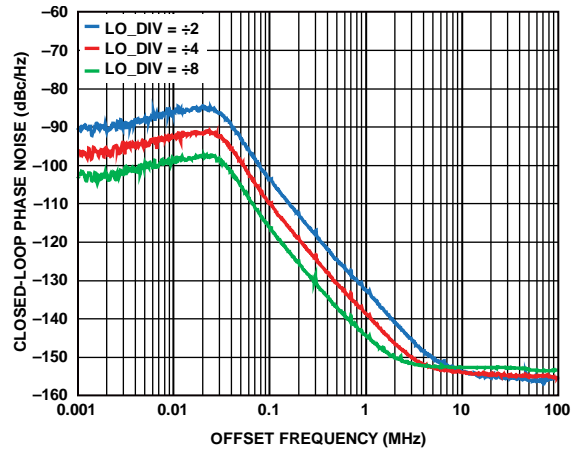

Figure 63. VCO\_0 Closed-Loop Phase Noise vs. Offset Frequency for Various LO\_DIV Dividers,  $f_{VCO_0} = 5.1\text{ GHz}$

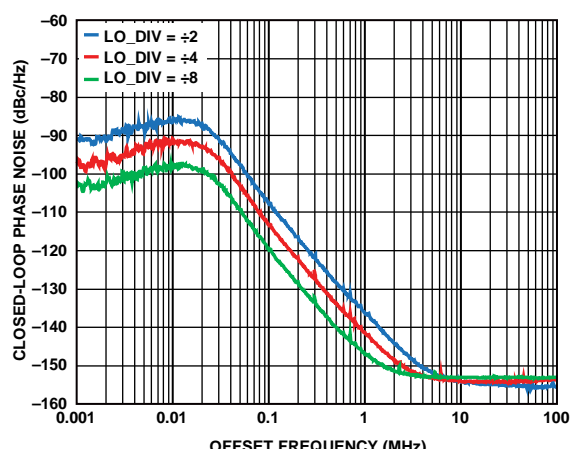

Figure 64. VCO\_1 Closed-Loop Phase Noise vs. Offset Frequency for Various LO\_DIV Dividers,  $f_{VCO_1} = 4.5\text{ GHz}$

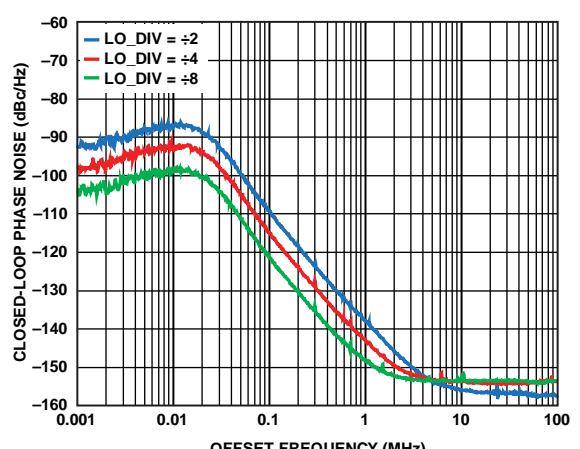

Figure 65. VCO\_2 Closed-Loop Phase Noise vs. Offset Frequency for Various LO\_DIV Dividers,  $f_{VCO_2} = 3.8\text{ GHz}$

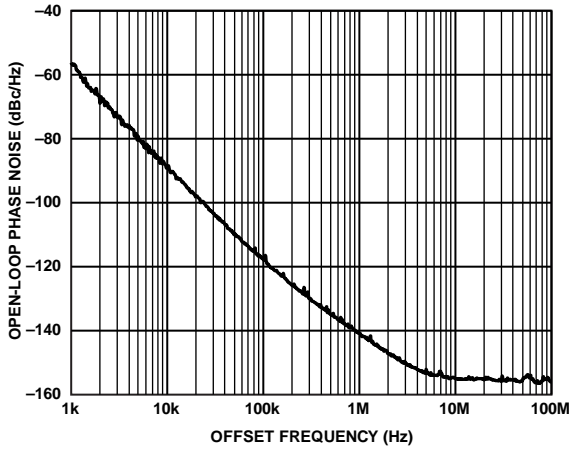

Figure 66. VCO\_3 Open-Loop Phase Noise vs. Offset Frequency,  $f_{VCO\_3} = 1.6$  GHz, Divide by Two Selected,  $V_{COVTUNE} = 1.5$  V

14115-163

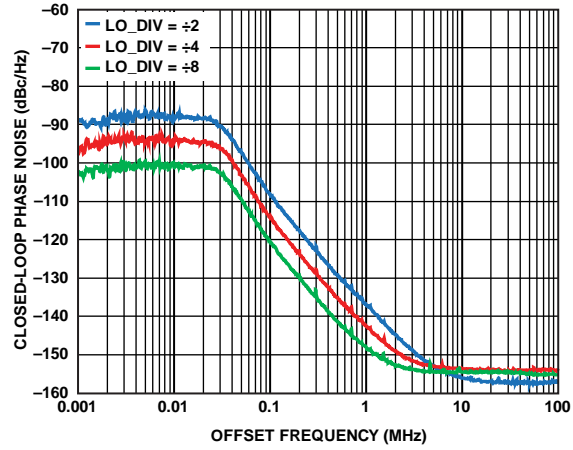

Figure 69. VCO\_3 Closed-Loop Phase Noise for Various LO\_DIV Dividers vs. Offset Frequency,  $f_{VCO\_3} = 3.2$  GHz

14115-066

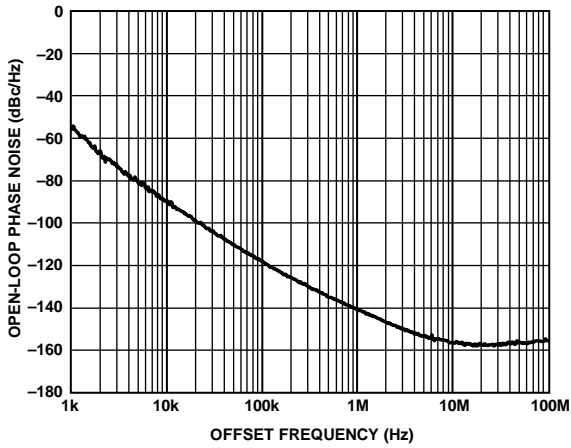

Figure 67. VCO\_4 Open-Loop Phase Noise vs. Offset Frequency,  $f_{VCO\_4} = 3.087$  GHz, Divide by One Selected,  $V_{COVTUNE} = 1.5$  V

14115-567

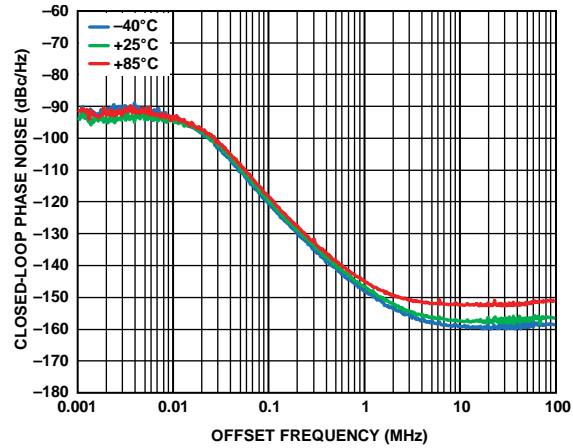

Figure 70. VCO\_4 Closed-Loop Phase Noise for Various Temperatures vs. Offset Frequency,  $f_{VCO\_4} = 1.536$  GHz, Divide by Two Selected

14115-570

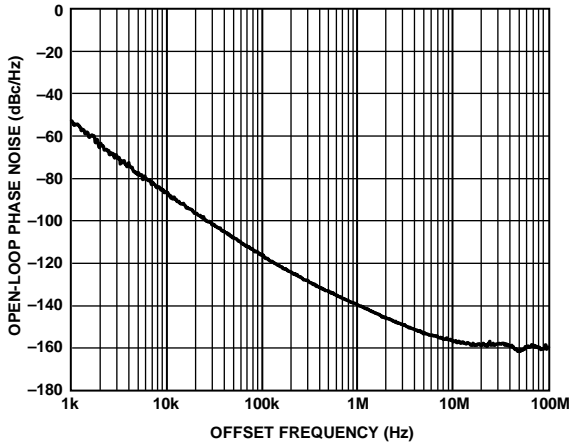

Figure 68. VCO\_5 Open-Loop Phase Noise vs. Offset Frequency,  $f_{VCO\_5} = 3.375$  GHz, Divide by One Selected,  $V_{COVTUNE} = 1.5$  V

14115-568

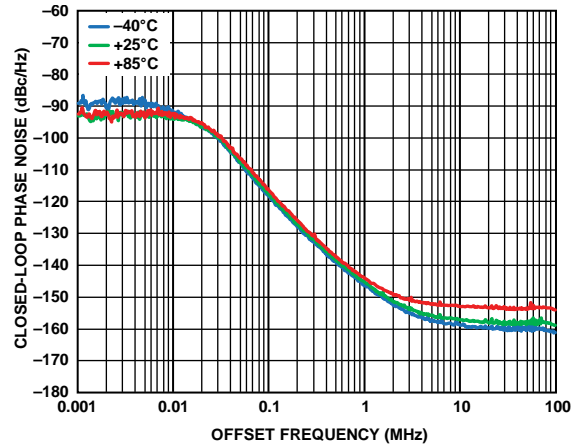

Figure 71. VCO\_5 Closed-Loop Phase Noise for Various Temperatures vs. Offset Frequency,  $f_{VCO\_5} = 1.688$  GHz, Divide by Two Selected

14115-571



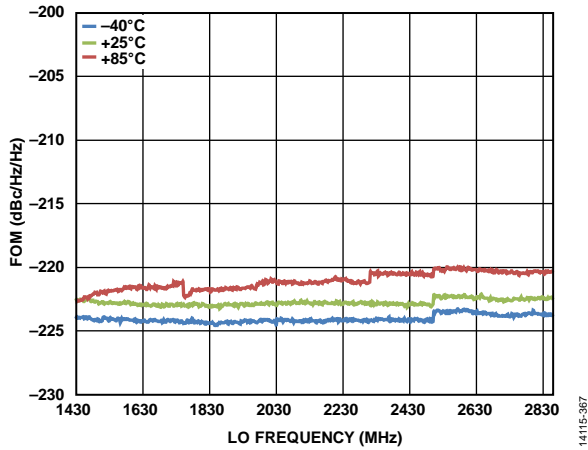

Figure 72. PLL Figure of Merit (FOM) vs. LO Frequency, Integer Mode

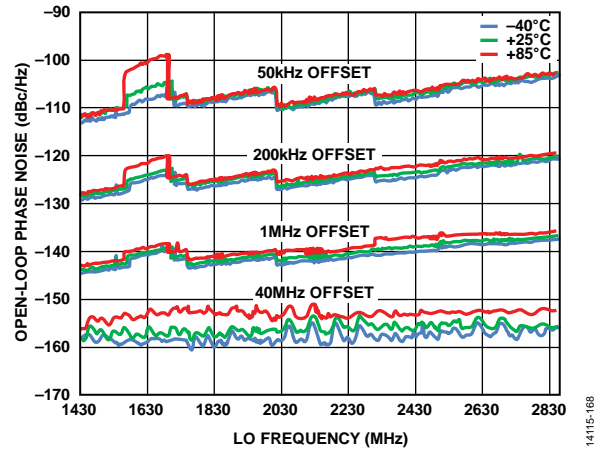

Figure 75. Open-Loop Phase Noise vs. LO Frequency, Divide by Two Selected

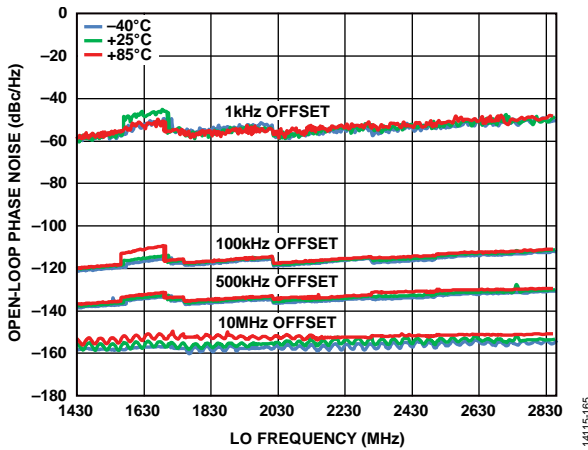

Figure 73. Open-Loop Phase Noise vs. LO Frequency, Divide by Two Selected

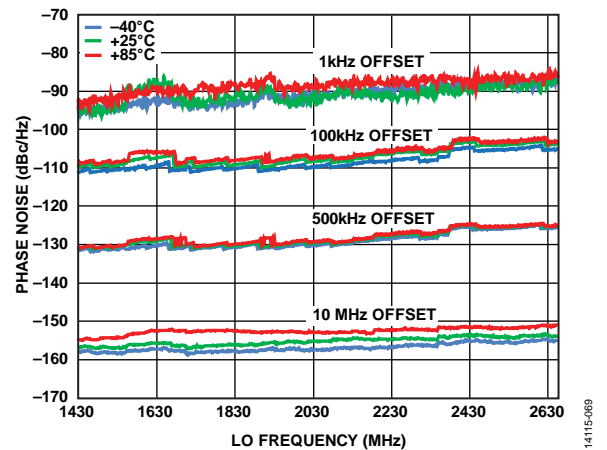

Figure 76. Integer Loop Filter Phase Noise vs. LO Frequency, Divide by Two Selected, Offset = 1 kHz, 100 kHz, 500 kHz, and 10 MHz

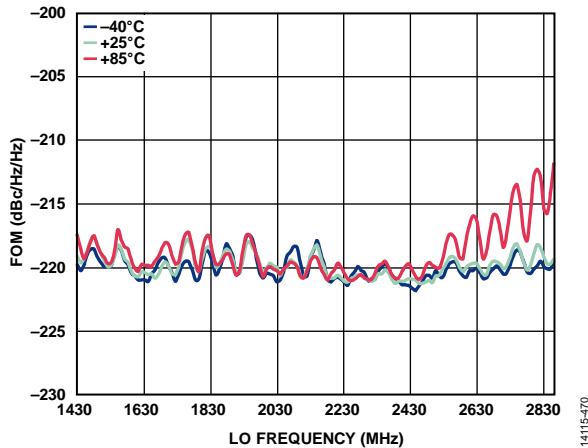

Figure 74. PLL Figure of Merit (FOM) vs. LO Frequency, Fractional Mode, Offset = 45 kHz, Bleed = 125  $\mu$ A

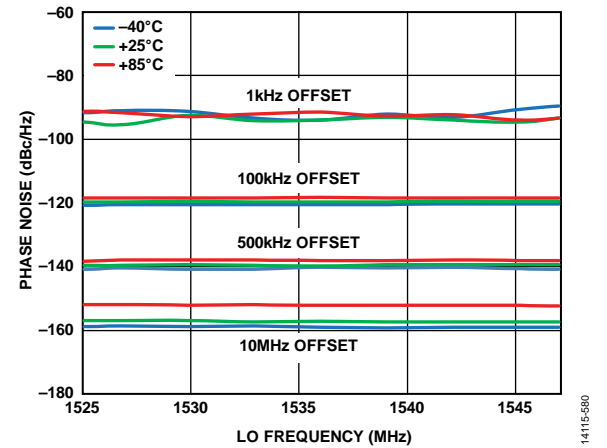

Figure 77. VCO\_4 GSM Loop Filter Phase Noise, Divide by Two Selected, Offset = 1 kHz, 100 kHz, 500 kHz, and 10 MHz

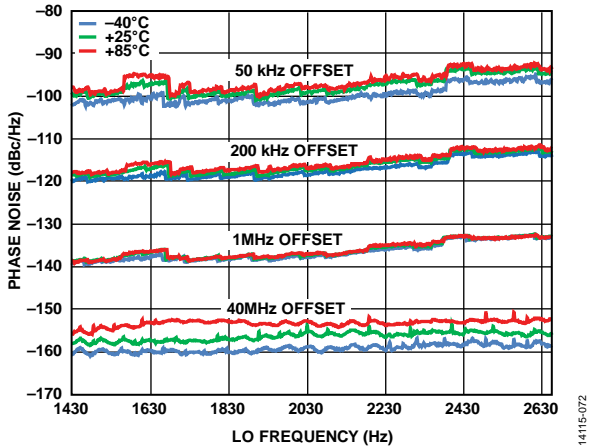

Figure 78. Integer Loop Filter Phase Noise vs. LO Frequency, Divide by Two Selected, Offset = 50 kHz, 200 kHz, 1 MHz, and 40 MHz

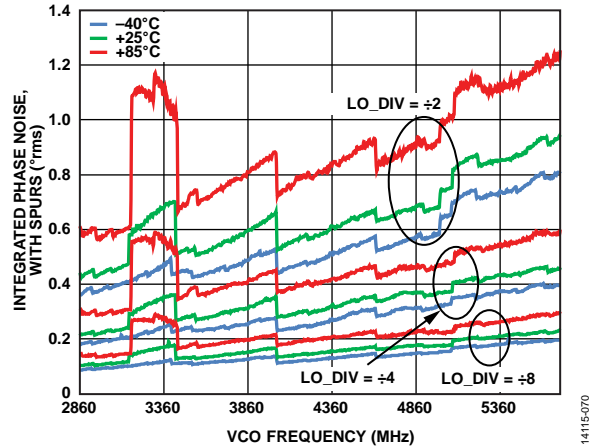

Figure 81. 10 kHz to 40 MHz Integrated Phase Noise vs. VCO Frequency, Divide by Two, Four, and Eight, Including Spurs

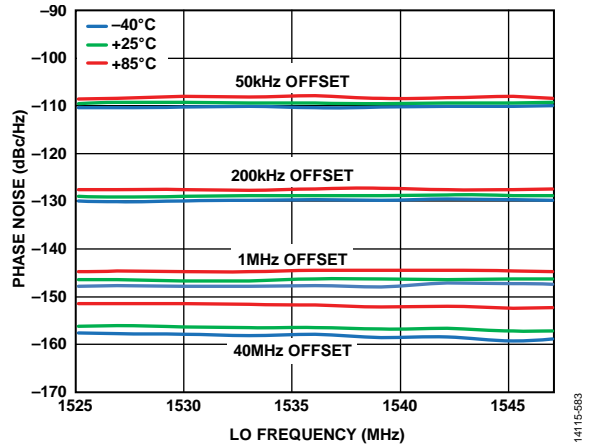

Figure 79. VCO\_4 GSM Loop Filter Phase Noise, Divide by Two Selected, Offset = 50 kHz, 200 kHz, 1 MHz, and 40 MHz

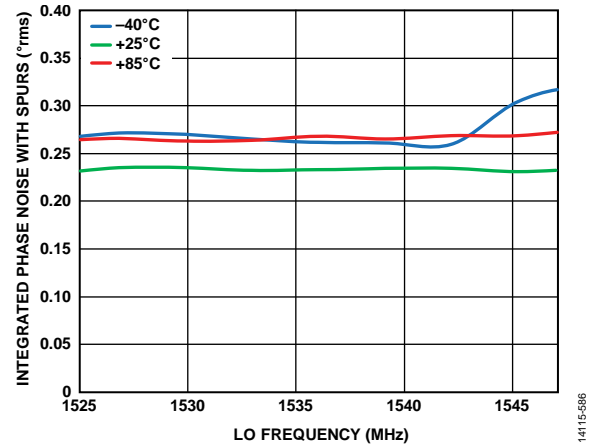

Figure 82. VCO\_4 10 kHz to 40 MHz Integrated Phase Noise vs. VCO Frequency, For Various Temperatures, Including Spurs

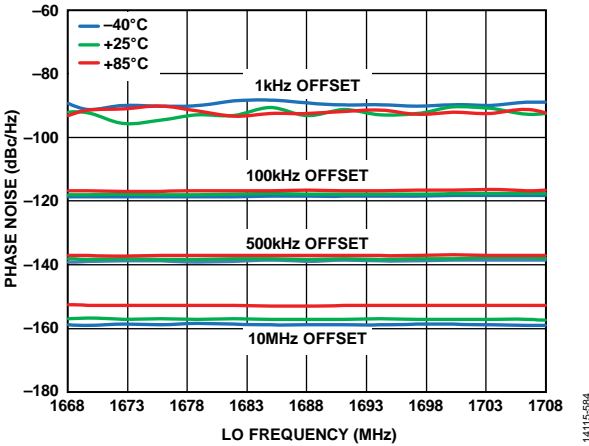

Figure 80. VCO\_5 GSM Loop Filter Phase Noise, Divide by Two Selected, Offset = 1 kHz, 100 kHz, 500 kHz, and 10 MHz

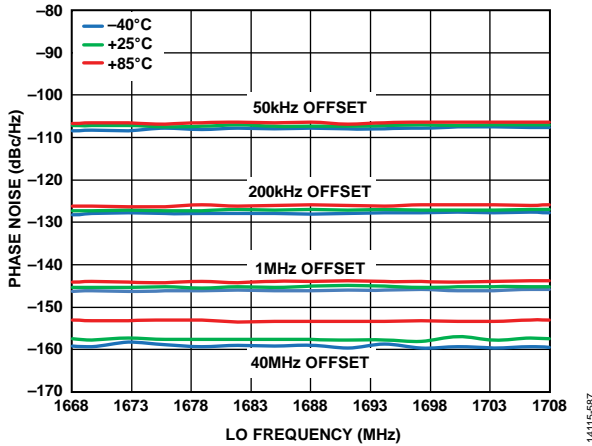

Figure 83. VCO\_5 GSM Loop Filter Phase Noise, Divide by Two Selected, Offset = 50 kHz, 200 kHz, 1 MHz, and 40 MHz

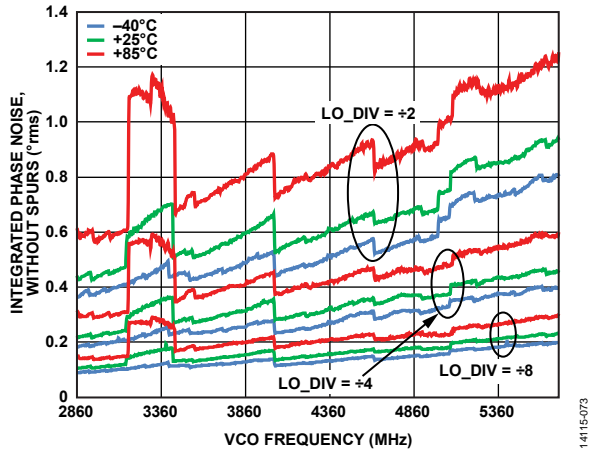

Figure 84. 10 kHz to 40 MHz Integrated Phase Noise vs. VCO Frequency, Divide by Two, Four, and Eight, Excluding Spurs

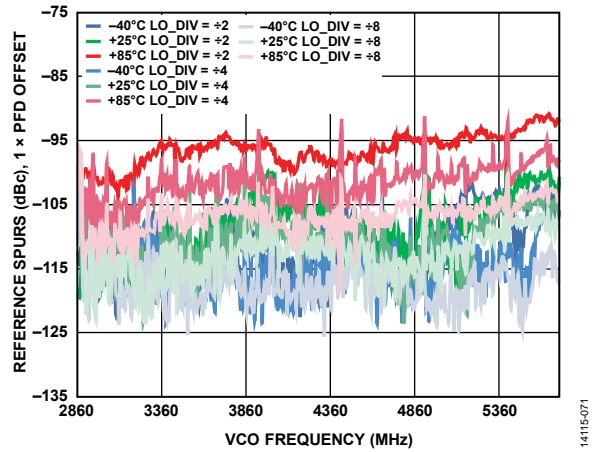

Figure 87.  $f_{PFD}$  Reference Spurs vs. VCO Frequency,  $1 \times PFD$  Offset, Measured at LO Output, Integer Mode

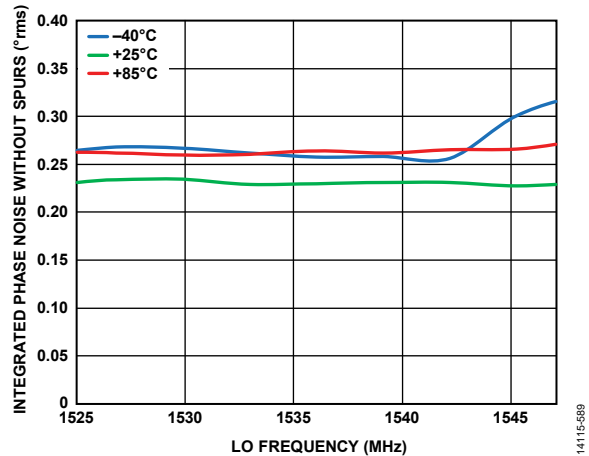

Figure 85. VCO\_4 10 kHz to 40 MHz Integrated Phase Noise vs. VCO Frequency, For Various Temperatures, Excluding Spurs

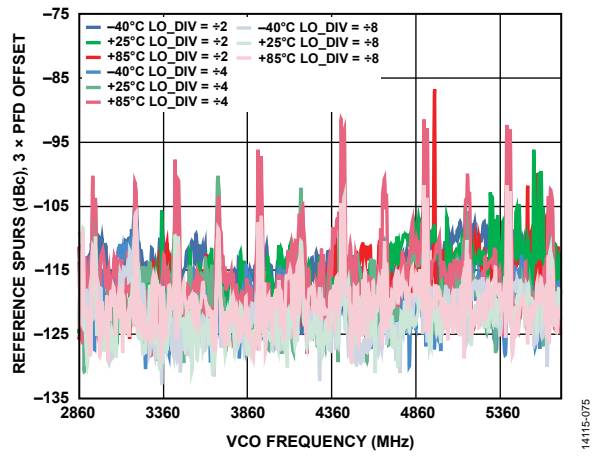

Figure 88.  $f_{PFD}$  Reference Spurs vs. VCO Frequency,  $3 \times PFD$  Offset, Measured at LO Output, Integer Mode

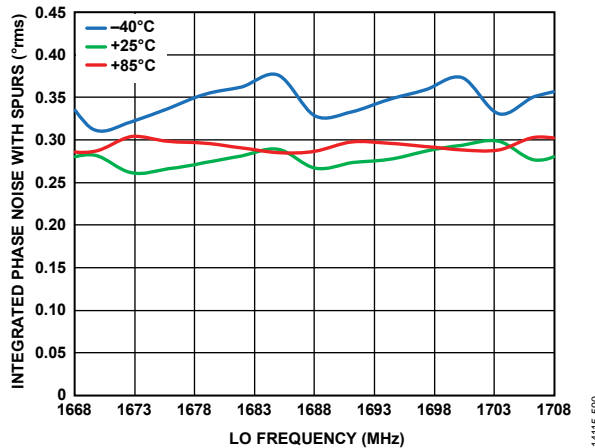

Figure 86. VCO\_5 10 kHz to 40 MHz Integrated Phase Noise vs. VCO Frequency, For Various Temperatures, Including Spurs

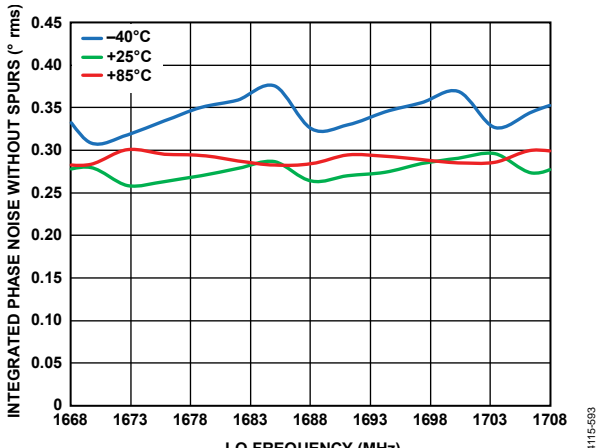

Figure 89. VCO\_5 10 kHz to 40 MHz Integrated Phase Noise vs. VCO Frequency, For Various Temperatures, Excluding Spurs

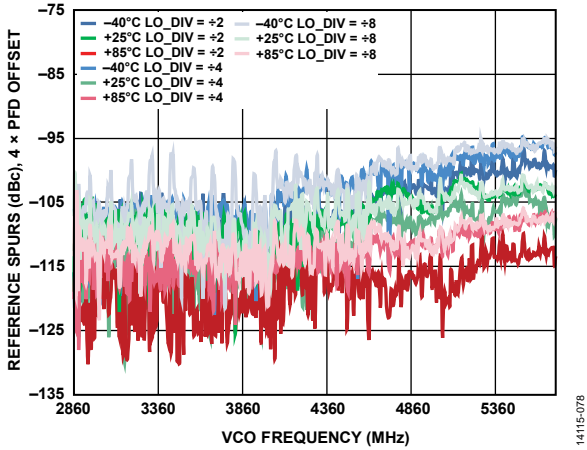

Figure 90.  $f_{PFD}$  Reference Spurs vs. VCO Frequency,  $2 \times$  PFD Offset, Measured at LO Output, Integer Mode

14115-078

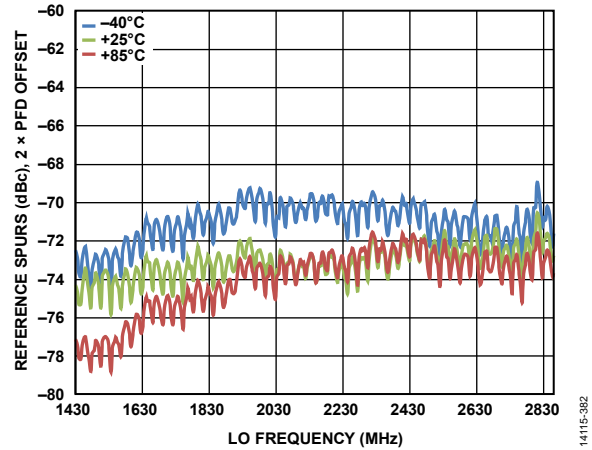

Figure 93.  $f_{PFD}$  Reference Spurs vs. LO Frequency,  $2 \times$  PFD Offset, Measured at LO Output, Fractional Mode

14115-382

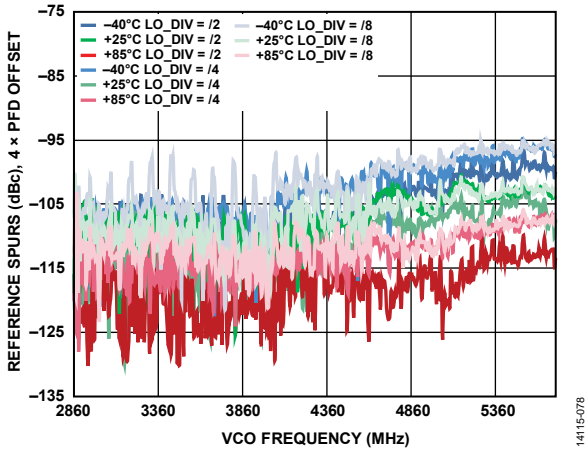

Figure 91.  $f_{PFD}$  Reference Spurs vs. VCO Frequency,  $4 \times$  PFD Offset, Measured at LO Output, Integer Mode

14115-078

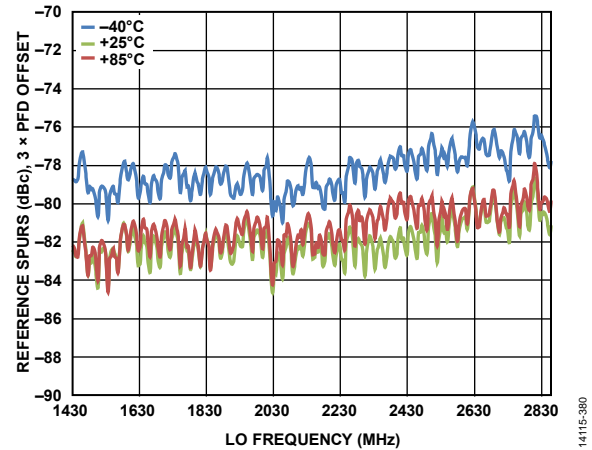

Figure 94.  $f_{PFD}$  Reference Spurs vs. LO Frequency,  $3 \times$  PFD Offset, Measured at LO Output, Fractional Mode

14115-380

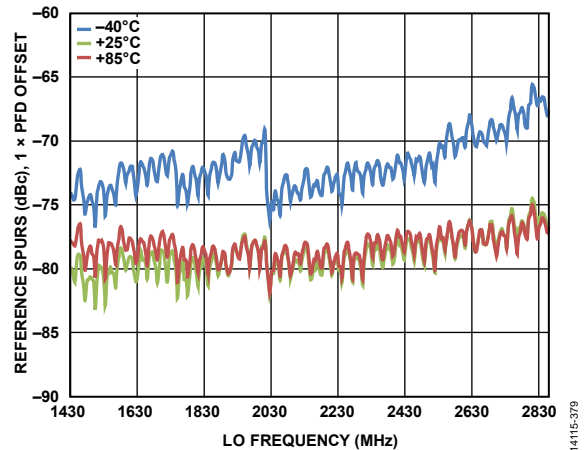

Figure 92.  $f_{PFD}$  Reference Spurs vs. LO Frequency,  $1 \times$  PFD Offset, Measured at LO Output, Fractional Mode

14115-379

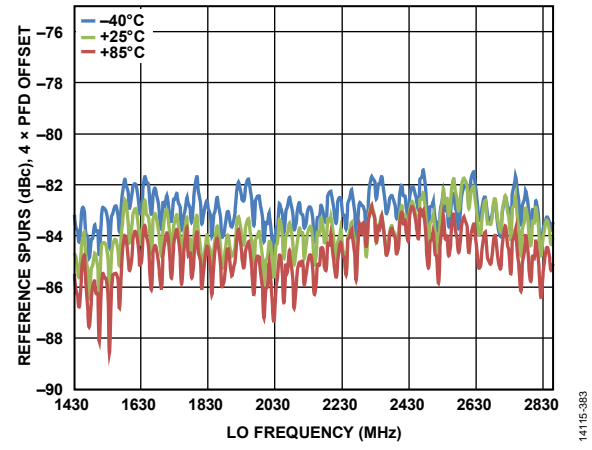

Figure 95.  $f_{PFD}$  Reference Spurs vs. LO Frequency,  $4 \times$  PFD Offset, Measured at LO Output, Fractional Mode

14115-383

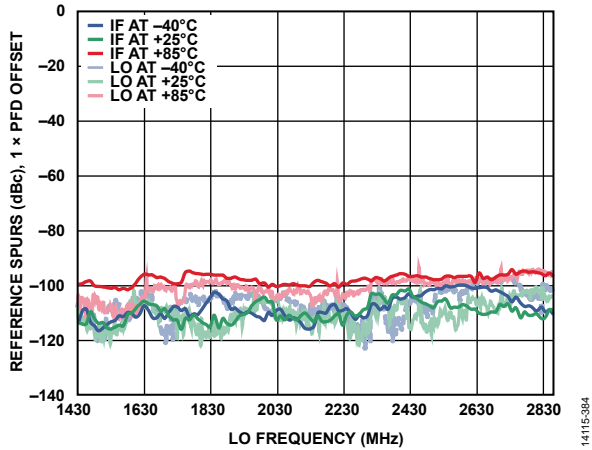

Figure 96.  $f_{PFD}$  Reference Spurs vs. LO Frequency, Divide by Two Selected,  $1 \times$  PFD Offset, Measured on LO Output and IF Output

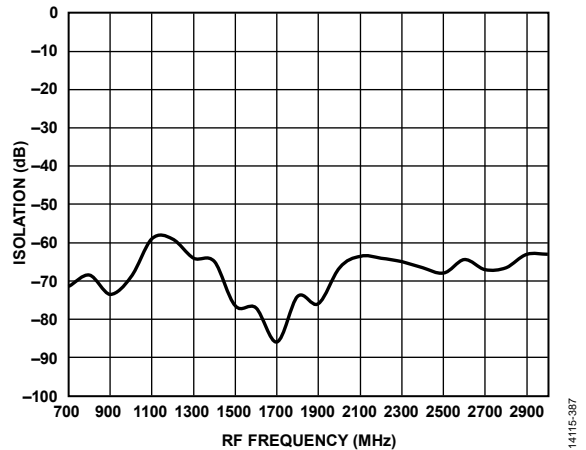

Figure 99. RF to LO Output Feedthrough,  $LO\_DRV\_LVL = 0$

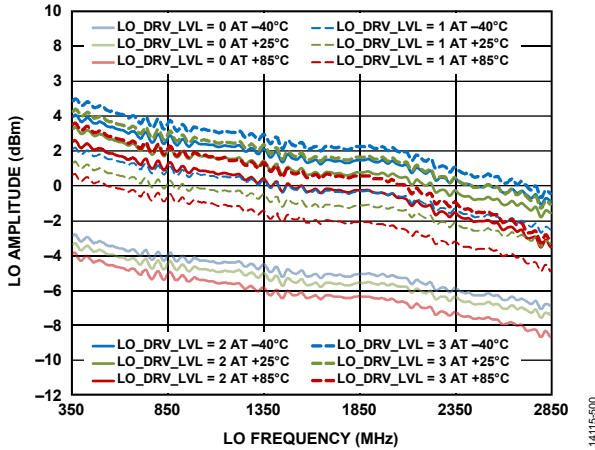

Figure 97. LO Amplitude vs. LO Frequency,  $LO\_DRV\_LVL = 0, 1, 2,$  and  $3$

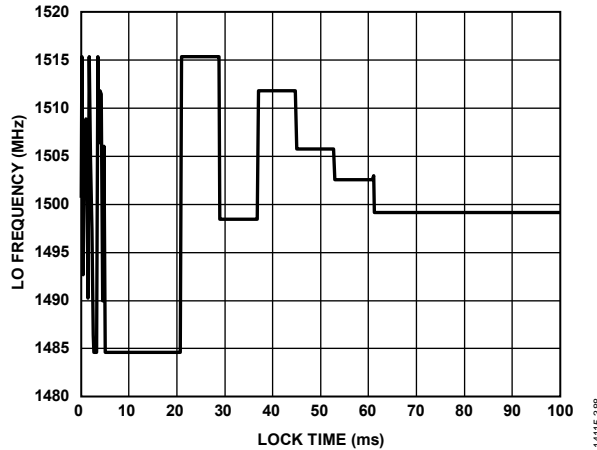

Figure 100. LO Frequency Settling Time, Integer Mode Loop Filter, Integer Mode

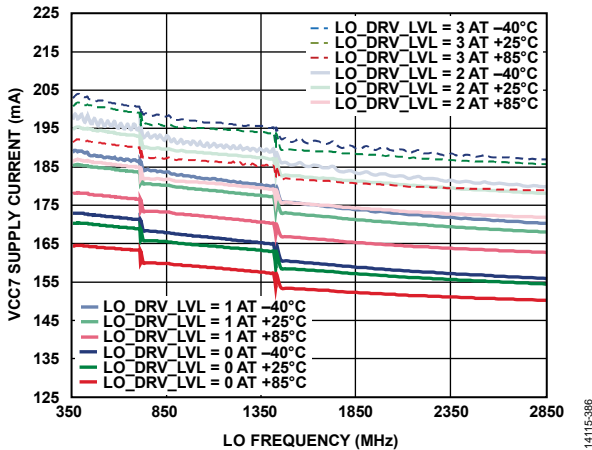

Figure 98. Supply Current for VCC7 vs. LO Frequency,  $LO\_DRV\_LVL = 0, 1, 2,$  and  $3$

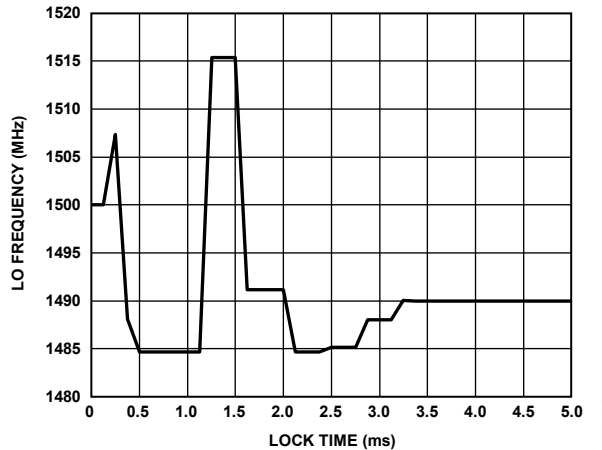

Figure 101. LO Frequency Settling Time, Fractional Loop Filter, Fractional Mode

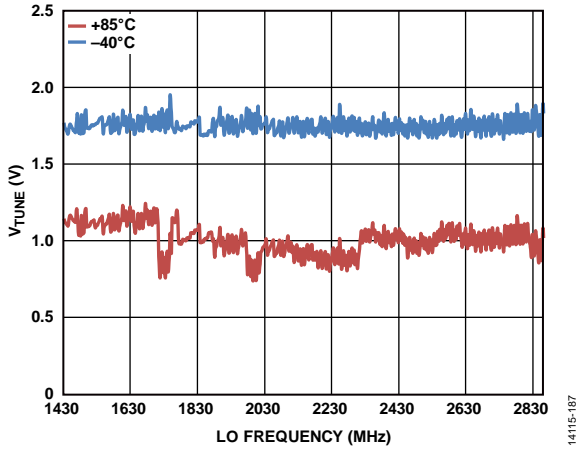

Figure 102. VCO Tuning Voltage ( $V_{TUNE}$ ) vs. LO Frequency for Lock at Cold Drift to Hot

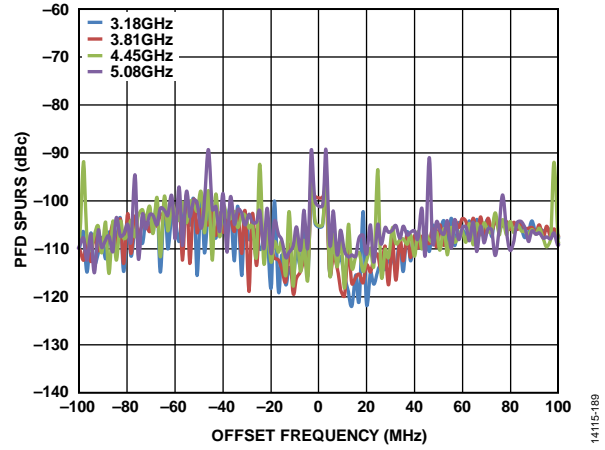

Figure 104. PFD Spurs vs. Offset Frequency for Four VCOs, Integer Mode

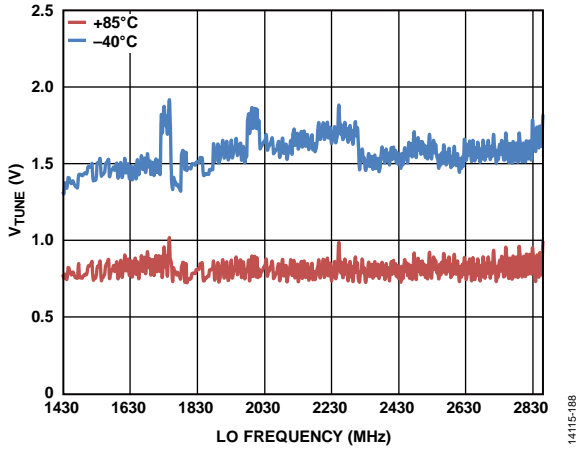

Figure 103.  $V_{TUNE}$  vs. LO Frequency for Lock at Hot Drift to Cold

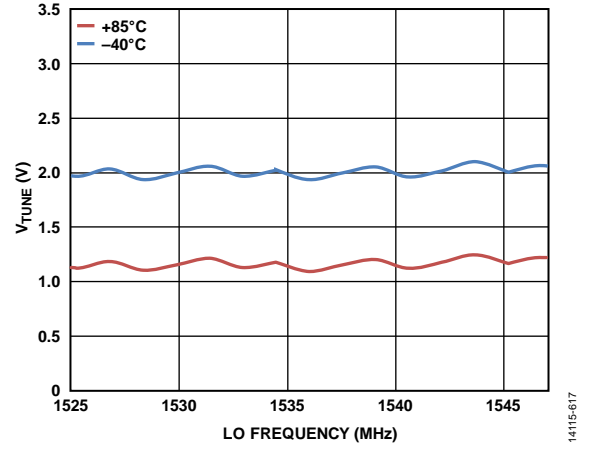

Figure 105. VCO\_4  $V_{TUNE}$  vs. LO Frequency for Lock at Hot Drift to Cold

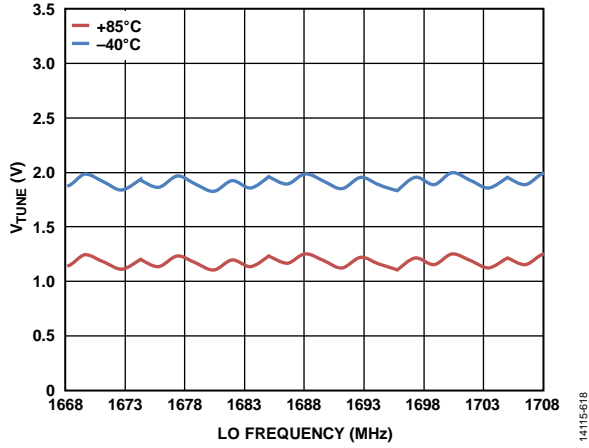

Figure 106. VCO\_5  $V_{TUNE}$  vs. LO Frequency for Lock at Hot Drift to Cold

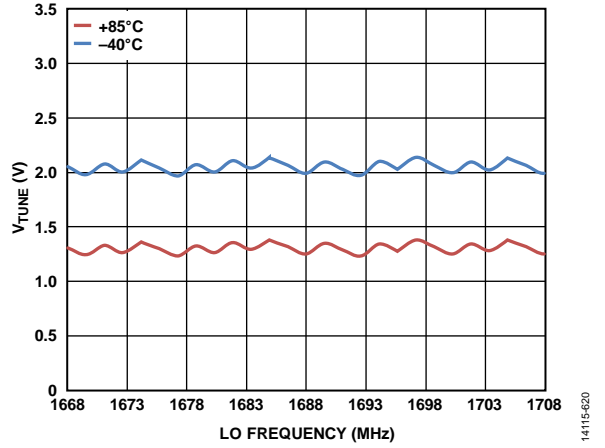

Figure 108. VCO\_5  $V_{TUNE}$  vs. LO Frequency for Lock at Cold Drift to Hot

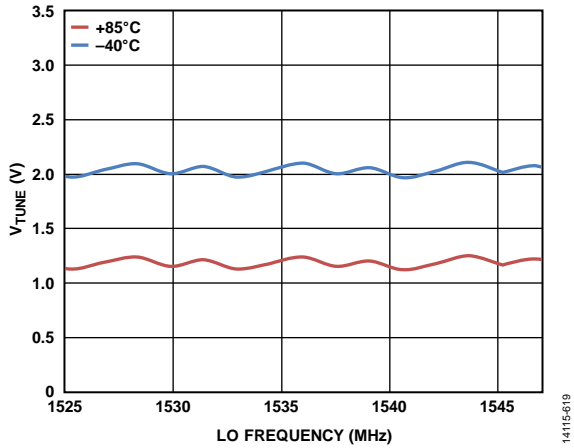

Figure 107. VCO\_4  $V_{TUNE}$  vs. LO Frequency for Lock at Cold Drift to Hot

**SPURIOUS PERFORMANCE**

( $N \times f_{RF}$ ) – ( $M \times f_{LO}$ ) spur measurements were made using the standard evaluation board. Mixer spurious products are measured in dBc from the IF output power level. Data was measured only for frequencies less than 6 GHz; blank cells indicate frequencies that were not measured. Typical noise floor of the measurement system = –100 dBm.

**High Performance Mode**

$V_S$  = high performance mode,  $T_A$  = 25°C,  $Z_O$  = 50 Ω,  $f_{REF}$  = 122.88 MHz,  $f_{REF}$  power = 4 dBm,  $f_{PFD}$  = 1.536 MHz, low-side LO injection, optimum RFB and LPF settings, unless otherwise noted.

**Table 11. RF = 900 MHz, LO = 697 MHz**

		M									
		0	1	2	3	4	5	6	7	8	9
N	0		–27.1	–32.1	–39.1	–27.0	–54.2	–48.5	–69.3	–65.6	
	1	–35.5	0.0	–52.5	–18.4	–56.6	–43.6	–66.7	–53.5	–87.4	–73.5
	2	–55.3	–68.9	–68.8	–73.4	–64.9	<–100	–68.3	<–100	–80.6	<–100
	3	–88.2	–88.4	<–100	–79.5	<–100	–94.1	<–100	<–100	<–100	<–100
	4	<–100	–56.6	<–100	<–100	<–100	<–100	<–100	<–100	<–100	<–100
	5	<–100	–43.6	<–100	<–100	<–100	<–100	<–100	<–100	<–100	<–100
	6	<–100	–66.7	<–100	<–100	<–100	<–100	<–100	<–100	<–100	<–100
	7		–53.5	<–100	<–100	<–100	<–100	<–100	<–100	<–100	<–100
	8			<–100	<–100	<–100	<–100	<–100	<–100	<–100	<–100
	9					<–100	<–100	<–100	<–100	<–100	<–100

**Table 12. RF = 1900 MHz, LO = 1697 MHz**

		M									
		0	1	2	3	4	5	6	7	8	9
N	0		–37.0	–31.2	–64.2						
	1	–30.2	0.0	–47.9	–52.1	–74.4					
	2	–70.8	–71.9	–81.6	–81.2	–67.2	<–100				
	3	<–100	<–100	–93.5	–75.2	<–100	<–100	<–100			
	4		<–100	<–100	<–100	<–100	<–100	<–100	<–100	<–100	
	5				<–100	<–100	<–100	<–100	<–100	<–100	<–100
	6					<–100	<–100	<–100	<–100	<–100	<–100
	7						<–100	<–100	<–100	<–100	<–100
	8							<–100	<–100	<–100	<–100
	9								<–100	<–100	<–100

**Table 13. RF = 2500 MHz, LO = 2297 MHz**

		M									
		0	1	2	3	4	5	6	7	8	9
N	0		–40.7	–44.1							
	1	–29.0	0.0	–49.4	–58.7						
	2	–81.0	–87.3	–75.4	–79.0	–84.7					
	3		<–100	–91.9	–74.7	<–100	<–100				
	4			<–100	<–100	<–100	<–100	<–100			
	5				<–100	<–100	<–100	<–100	<–100	<–100	
	6					<–100	<–100	<–100	–92.5	<–100	<–100
	7							<–100	<–100	<–100	<–100
	8								<–100	<–100	<–100
	9									<–100	<–100



**High Efficiency Mode**

$V_S$  = high efficiency mode,  $T_A = 25^\circ\text{C}$ ,  $Z_O = 50 \Omega$ ,  $f_{REF} = 122.88 \text{ MHz}$ ,  $f_{REF}$  power = 4 dBm,  $f_{PFD} = 1.536 \text{ MHz}$ , low-side LO injection, optimum RFB and LPF settings, unless otherwise noted.

**Table 14. RF = 900 MHz, LO = 697 MHz**

		M									
		0	1	2	3	4	5	6	7	8	9
N	0		-30.4	-34.1	-46.7	-29.6	-57.4	-51.2	-74.7	-62.7	
	1	-37.7	0.0	-52.6	-19.2	-61.6	-44.3	-64.0	-53.6	-91.8	-73.2
	2	-70.3	-66.4	-68.8	-71.9	-59.9	-93.0	-67.8	<-100	-79.0	<-100
	3	-86.4	-81.0	-96.4	-74.7	<-100	-85.0	<-100	<-100	<-100	<-100
	4	<-100	<-100	-97.9	<-100	<-100	<-100	<-100	<-100	<-100	<-100
	5	<-100	<-100	<-100	<-100	<-100	<-100	<-100	<-100	<-100	<-100
	6	<-100	<-100	<-100	<-100	<-100	<-100	<-100	<-100	<-100	<-100
	7		<-100	<-100	<-100	<-100	<-100	<-100	<-100	<-100	<-100
	8			<-100	<-100	<-100	<-100	<-100	<-100	<-100	<-100
	9					<-100	<-100	<-100	<-100	<-100	<-100

**Table 15. RF = 1900 MHz, LO = 1697 MHz**

		M									
		0	1	2	3	4	5	6	7	8	9
N	0		-41.4	-35.1	-69.0						
	1	-30.5	0.0	-46.9	-52.2	-74.4					
	2	-71.5	-67.7	-74.6	-71.3	-63.6	<-100				
	3	<-100	<-100	-89.9	-67.7	<-100	<-100	<-100			
	4		<-100	<-100	<-100	<-100	<-100	<-100	<-100	<-100	
	5				<-100	<-100	<-100	<-100	<-100	<-100	<-100
	6					<-100	<-100	<-100	<-100	<-100	<-100
	7						<-100	<-100	<-100	<-100	<-100
	8							<-100	<-100	<-100	<-100
	9								<-100	<-100	<-100

**Table 16. RF = 2500 MHz, LO = 2297 MHz**

		M									
		0	1	2	3	4	5	6	7	8	9
N	0		-42.3	-48.6							
	1	-29.1	0.0	-48.6	-59.4						
	2	-75.6	-88.8	-71.6	-70.8	-77.0					
	3		-59.4	-86.2	-66.9	<-100	<-100				
	4			-77.0	<-100	<-100	<-100	<-100			
	5				<-100	<-100	<-100	<-100	<-100	<-100	
	6					<-100	<-100	<-100	<-100	<-100	<-100
	7							<-100	<-100	<-100	<-100
	8								<-100	<-100	<-100
	9									<-100	<-100

## THEORY OF OPERATION

The ADRF6614 consists of two primary components: the RF subsystem and the LO subsystem. The combination of design, process, and packaging technology allows the functions of these subsystems to be integrated into a single die, using mature packaging and interconnection technologies to provide a high performance device with excellent electrical, mechanical, and thermal properties. The wideband frequency response and flexible frequency programming simplifies the receiver design, saves on-board space, and minimizes the need for external components.

The RF subsystem consists of an integrated, tunable, low loss RF balun, a double balanced, passive MOSFET mixer, a tunable sum termination network, and an IF amplifier.

The LO subsystem consists of a multistage, limiting LO amplifier. The purpose of the LO subsystem is to provide a large, fixed amplitude, balanced signal to drive the mixer independent of the level of the LO input. A schematic of the device is shown in Figure 110.

### RF SUBSYSTEM

The single-ended, 50  $\Omega$  RF input is internally transformed to a balanced signal using a tunable, low loss, unbalanced to balanced (balun) transformer. This transformer is made possible by an extremely low loss metal stack, which provides both excellent balance and dc isolation for the RF port. Although the port can be dc connected, it is recommended to use a blocking capacitor to avoid running excessive dc current through the device. The RF balun can easily support an RF input frequency range of 700 MHz to 3000 MHz. This balun is tuned over the frequency range by a SPI controlled switched capacitor network at the output of the RF balun.

The resulting balanced RF signal is applied to a passive mixer that commutates the RF input in accordance with the output of the LO subsystem. The passive mixer is a balanced, low loss switch that adds minimum noise to the frequency translation. The only noise contribution from the mixer is due to the resistive loss of the switches, which is in the order of a few ohms.

The IF amplifier is a balanced feedback design that simultaneously provides the gain, noise figure, and input impedance required to achieve the overall performance. The balanced open-collector output of the IF amplifier, with an impedance modified by the feedback within the amplifier, permits the output to be connected directly to a high impedance filter, a differential amplifier, or an

analog-to-digital converter (ADC) input while providing optimum second-order intermodulation suppression. The differential output impedance of the IF amplifier is approximately 200  $\Omega$ . If operation in a 50  $\Omega$  system is desired, the output can be transformed to 50  $\Omega$  by using a 4:1 transformer or an LC impedance matching network.

### EXTERNAL LO GENERATION

The ADRF6614 LO can be generated by an externally applied source or by using the internal PLL synthesizer. To select the external LO mode, write 011 to Register 0x22, Bits[2:0] and apply the differential LO signal to Pin 4 (EXTVCOIN+) and Pin 5 (EXTVCOIN-).

Internal dividers allow the externally applied LO signal to be divided before this signal arrives at the mixer LO input. The divider value is set by Register 0x22, Bits[5:3] and has possible values of 1, 2, 4, and 8. With the divider set to 1, the externally applied LO input frequency range is 250 MHz to 2850 MHz. When using a divider value of other than 1, the maximum externally applied LO frequency is 5700 MHz.

The external LO input pins present a broadband differential 50  $\Omega$  input impedance. The EXTVCOIN+ and EXTVCOIN- input pins must be ac-coupled. When not in use, EXTVCOIN+ and EXTVCOIN- can be left unconnected.

### INTERNAL LO GENERATION

#### Reference Input Circuitry

The ADRF6614 includes an on-chip PLL for LO synthesis. The PLL, shown in Figure 109, consists of a reference input and input dividers, a PFD, a charge pump, VCOs, and a programmable fractional/integer divider with a 2 $\times$  prescaler.

The reference path takes in a reference clock and divides it by a factor of 1 to 8191 before passing it to the PFD. The PFD compares this signal to the divided down signal from the VCO. Depending on the PFD polarity selected, the PFD sends an up or down signal to the charge pump if the VCO signal is slow or fast compared to the reference frequency. The charge pump sends a current pulse to the off-chip loop filter to increase or decrease the tuning voltage (VCOVTUNE).

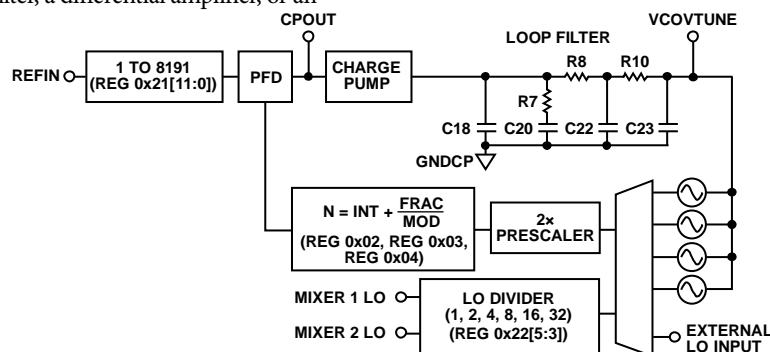

Figure 109. LO Generation Block Diagram

In-band (within the band of the loop filter) phase noise performance is typically limited by the reference source. Due to the inherent phase noise reduction when performing frequency division, improved in-band phase noise performance can be achieved with higher reference divide values. However, the divide chain adds its own small amount of phase noise; thus, there is a limit on how much improvement can be gained by increasing the divider value.

### Loop Filters

Defining a loop filter for the [ADRF6614](#) depends on several dynamic: the PLL REFIN and PFD frequency and desired PFD and fractional spur levels. Higher reference and PFD frequencies spread the PFD spurs over a wider bandwidth (wider separation between spurs), but also lead to higher levels of spurs coupling through the reference divider chain. Lower reference and PFD frequencies lower the spacing between PFD spurs, but the spur levels can be significantly improved by using lower frequencies. At lower PFD frequencies, it may also be possible to achieve the desired synthesizer frequency step size using the integer divider mode, therefore eliminating the risk of fractional spurs. Table 17 shows the recommended loop filter components and dynamic loop settings when using integer mode and PFD frequencies at less than 10 MHz.

**Table 17. Integer Mode Loop Filter Components and PLL Dynamic Settings**

Loop Filter Components	PLL Dynamic Settings
C18	1500 pF
R7	910 $\Omega$
C20	33 nF
R8	1.8 k $\Omega$
C22	560 pF
R10	20 k $\Omega$
C23	39 pF
CSCALE	8000 $\mu$ A
Bleed Current	0 $\mu$ A
ABLDLY	0.9 ns

If a smaller frequency step size is desired, the [ADRF6614](#) can be used in fractional mode. The 16-bit FRAC\_DIV and MOD\_DIV values available in the [ADRF6614](#) mean that small step sizes can be achieved with high PFD frequencies. PFD spurs may be higher in amplitude, but are spaced further apart. Fractional spurs may be present as well.

**Table 18. Fractional Mode Loop Filter Components and PLL Dynamic Settings**

Loop Filter Components	PLL Dynamic Settings
C18	1000 pF
R7	700 $\Omega$
C20	33 nF
R8	1.8 k $\Omega$
C22	560 pF
R10	20 k $\Omega$
C23	39 pF
CSCALE	500 $\mu$ A
Bleed Current	93.75 $\mu$ A
ABLDLY	0 ns

For GSM mode of operation at the PFD rate of 1.536 MHz, the recommended loop filter components and dynamic loop settings are shown in Table 19.

**Table 19. GSM Mode Loop Filter Components and PLL Dynamic Settings**

Loop Filter Components	PLL Dynamic Settings
C18	2200 pF
R7	1.2 k $\Omega$
C20	47 nF
R8	1 k $\Omega$
C22	1200 pF
R10	6.2 k $\Omega$
C23	330 pF
CSCALE	8 mA
Bleed Current	0 $\mu$ A
ABLDLY	0.9 ns

### VCOs and Dividers

The [ADRF6614](#) has six internal VCOs. Considering the range of these VCOs, the fixed 2 $\times$  prescaler after the VCO, and the LO\_DIV (1, 2, 4, 8, 16, and 32) range, the total LO range allows an RF generation of 200 MHz to 2700 MHz.

**Table 20. VCO Range**

VCO_SEL (Register 0x22, Bits[2:0])	Frequency Range (GHz)
000	4.6 to 5.7
001	4.02 to 4.6
010	3.5 to 4.02
011	2.85 to 3.5
100	3.050 to 3.094
101	3.336 to 3.416

For the VCO\_0, VCO\_1, VCO\_2, and VCO\_3 selections, it is required to set VTUNE\_DAC\_SLOPE (Register 0x49, Bits[13:9]) = 11d, VTUNE\_DAC\_OFFSET (Register 0x49, Bits[8:0]) = 184d, VCO\_LDO\_R2 (Register 0x22, Bits[11:8]) = 0d, and VCO\_LDO\_R4 (Register 0x22, Bits[15:12]) = 5d. For VCO\_4 and VCO\_5 selections, the required settings are VTUNE\_DAC\_SLOPE (Register 0x49, Bits[13:9]) = 9d, VTUNE\_DAC\_OFFSET (Register 0x49, Bits[8:0]) = 171d, VCO\_LDO\_R2 (Register 0x22, Bits[11:8]) = 2d, and VCO\_LDO\_R4 (Register 0x22, Bits[15:12]) = 10d. In transitioning from a GSM VCO (VCO\_4 and VCO\_5) to an octave VCO, the LDO settings must be changed before changing the VCO selection.

The N-divider divides down the differential VCO signal to the PFD frequency. The N-divider can be configured for fractional mode or integer mode by addressing the DIV\_MODE bit (Register 0x02, Bit 15). The default configuration is set for fractional mode.

The following equations can be used to determine the N value and the PLL frequency:

$$f_{PFD} = \frac{f_{VCO}}{2 \times N}$$

where:

$f_{PFD}$  is the phase frequency detector frequency.

$f_{VCO}$  is the voltage controlled oscillator frequency.

$N$  is the fractional divide ratio.

$$N = INT + \frac{FRAC}{MOD}$$

where:

$INT$  is the integer divide ratio programmed in Register 0x02.

$FRAC$  is the fractional divide ratio programmed in Register 0x03.

$MOD$  is the modulus divide ratio programmed in Register 0x04.

$$f_{LO} = \frac{f_{PFD} \times 2 \times N}{LO\_DIVIDER}$$

where:

$f_{LO}$  is the LO frequency going to the mixer core when the loop is locked.

$LO\_DIVIDER$  is the final divider block that divides the VCO frequency down by 1, 2, 4, or 8 before it reaches the mixer (see Table 21). This control is located in the  $LO\_DIV$  bits (Register 0x22, Bits[5:3]).

**Table 21. LO Divider**

LO_DIV (Register 0x22, Bits[5:3])	LO_DIVIDER
00	1
01	2
10	4
11	8

The lock detect signal is available as one of the selectable outputs through the MUXOUT pin; a logic high indicates that the loop is locked. The MUXOUT pin is controlled by the REF\_MUX\_SEL bits (Register 0x21, Bits[14:13]); the PLL lock detect signal is the default configuration.

To ensure that the PLL locks to the desired frequency, follow the proper write sequence of the PLL registers. The PLL registers must be configured accordingly to achieve the desired frequency, and the last writes must be to Register 0x02 (INT\_DIV in Table 26), Register 0x03 (FRAC\_DIV in Table 26), or Register 0x04 (MOD\_DIV in Table 26). When one of these registers is programmed, an internal VCO calibration is initiated, which is the last step in locking the PLL.

The time it takes to lock the PLL after the last register is written can be broken down into two parts: VCO band calibration and loop settling.

After the last register is written, the PLL automatically performs a VCO band calibration to choose the correct VCO band. This calibration takes approximately 5120 PFD cycles. For a 40 MHz  $f_{PFD}$ , this corresponds to 128  $\mu$ s. After calibration is complete, the feedback action of the PLL causes the VCO to lock eventually to the correct frequency. The speed with which this locking occurs depends on the nonlinear cycle slipping behavior, as well as the small signal settling of the loop. For an accurate estimation of the lock time, download the [ADIsimPLL™](#) tool, which correctly captures these effects. In general, higher bandwidth loops tend to lock faster than lower bandwidth loops.

### Additional LO Controls

To access the LO signal going to the mixer core through the LOOUT+ and LOOUT– pins (Pin 13 and Pin 14), enable the LO\_DRV\_EN bit in Register 0x01, Bit 7. This setting offers direct monitoring of the LO signal to the mixer for debug purposes; or the LO signal can be used to daisy-chain many devices synchronously. One [ADRF6614](#) can serve as the master where the LO signal is sourced, and the subsequent slave devices share the same LO signal from the master. This flexibility substantially eases the LO requirements of a system with multiple LOs.

The LO output drive level is controlled by the LO\_DRV\_LVL bits (Register 0x22, Bits[7:6]). Table 22 shows the available drive levels.

**Table 22. LO Drive Levels**

LO_DRV_LVL (Register 0x22, Bits[7:6])	Amplitude (dBm)
00	–4
01	0.5
10	3
11	4.5

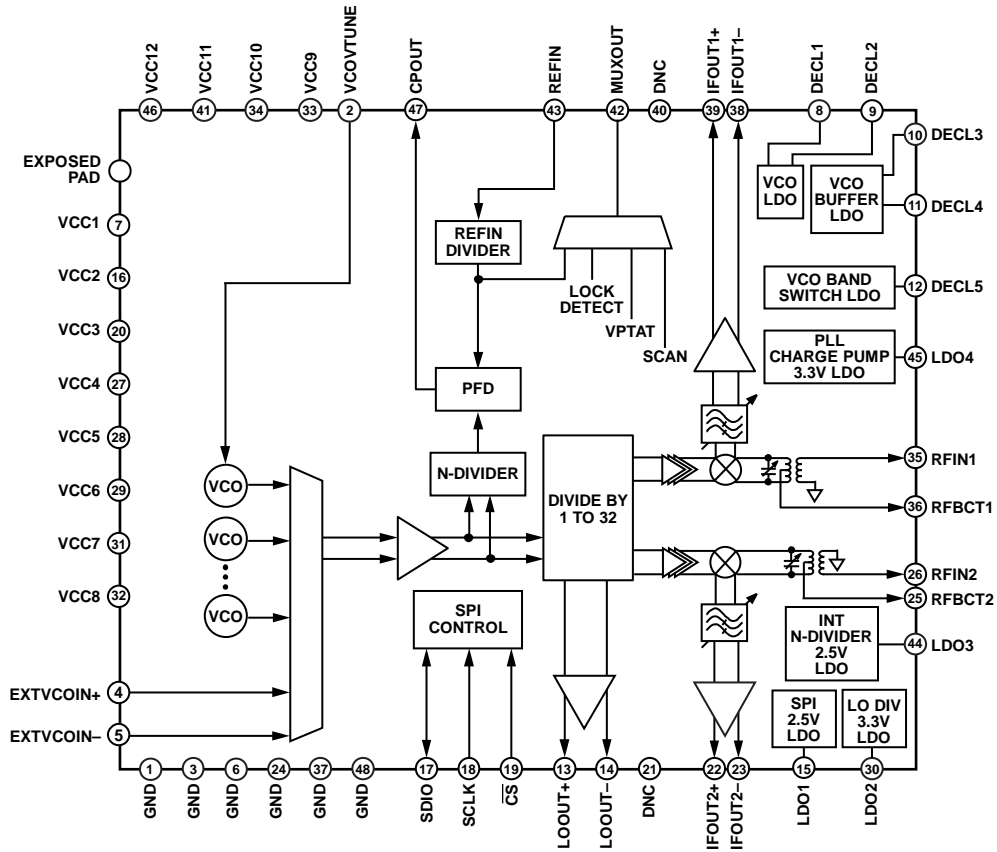

Figure 110. Simplified Schematic

14115-091

# APPLICATIONS INFORMATION

The ADRF6614 mixer is designed to downconvert radio frequencies (RF) primarily between 700 MHz and 3000 MHz to lower intermediate frequencies (IF) between 40 MHz to 500 MHz. Figure 111 depicts the basic connections of the mixer. It is

recommended to ac couple the RF and LO input ports to prevent nonzero dc voltages from damaging the RF balun or LO input circuit. A RFIN capacitor value of 22 pF is recommended.

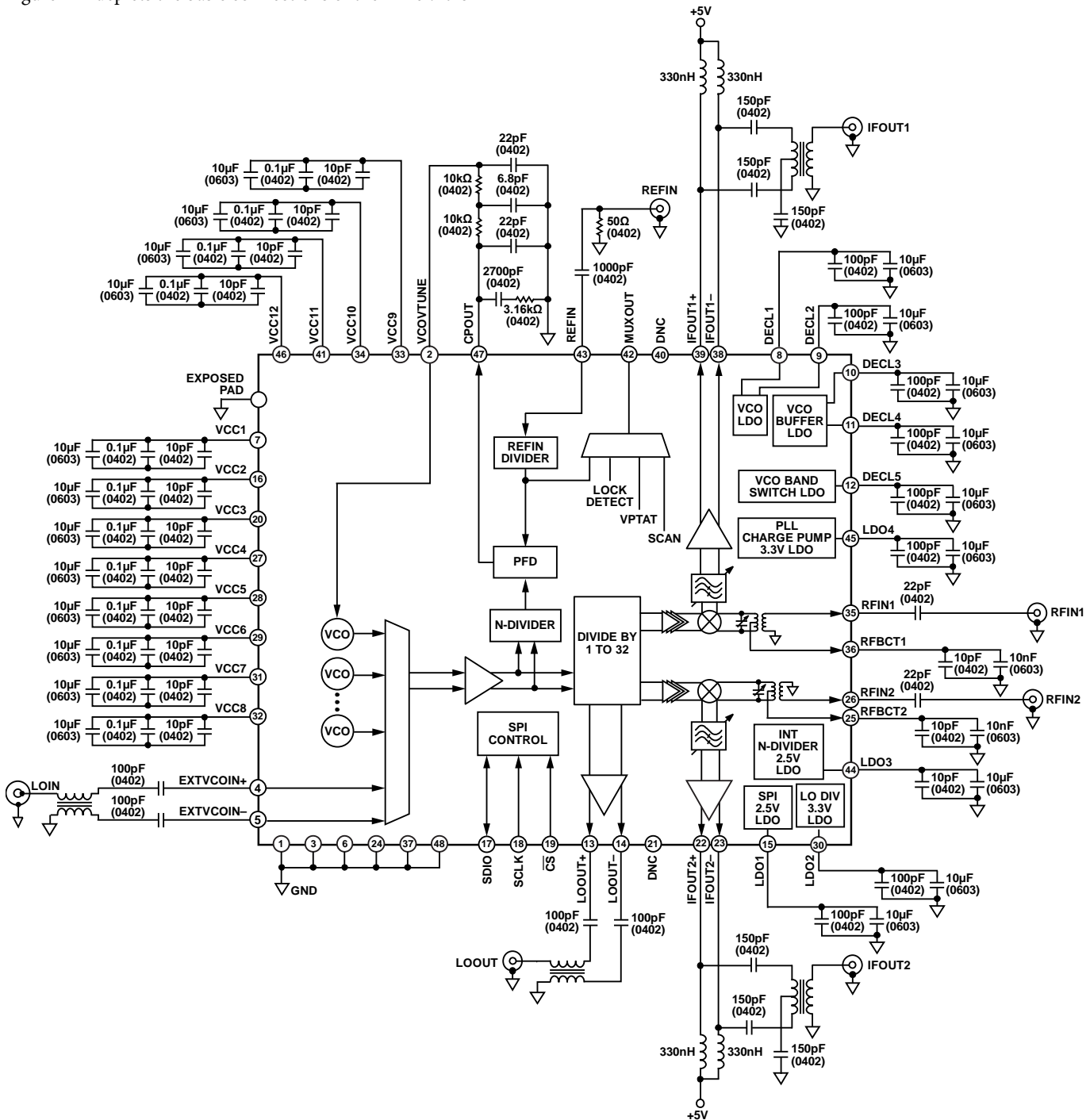

Figure 111. Basic Connections Diagram

## BASIC CONNECTIONS BY PIN DESCRIPTION

Table 23. Basic Connections

Pin No.	Mnemonic	Description	Basic Connection
5 V Power			Decouple to GND with a 10 $\mu$ F, a 0.1 $\mu$ F, and a 10 pF capacitor as close to the pin as possible.
7	VCC1	5 V VCO supply	
16	VCC2	5 V supply for SPI port	
20, 41	VCC3, VCC11	5 V biases for IF Channel 2 and IF Channel 1	
27, 28, 29, 32, 33, 34	VCC4, VCC5, VCC6, VCC8, VCC9, VCC10	5 V supplies for mixer LO amplifier	
31	VCC7	5 V supply for mixer LO divider chain	
46	VCC12	5 V supply for internal PLL	
Internal LDO Nodes			Decouple to GND with a 10 $\mu$ F and a 100 pF capacitor, as close to the pin as possible.
8, 9	DECL1, DECL2	VCO LDO outputs	
10, 11, 12	DECL3, DECL4, DECL5	External decoupling for VCO circuitry	
15	LDO1	External decoupling for internal 2.5 V SPI LDO	
30	LDO2	External decoupling for internal 3.3 V PLL/divider LDO	
44	LDO3	External decoupling for internal 2.5 V PLL LDO	
45	LDO4	External decoupling for internal 3.3 V PLL LDO	
GND			Connect directly to the PCB ground through a low impedance connection.
1	GND	External loop filter ground	
3, 6	GND	Common ground for external loop filter	
24, 37	GND	IF stage, Channel 2 and Channel 1 ground	
48	GND	External charge pump ground	
SPI			
17	SDIO	SPI port data input/output	
18	SCLK	SPI port clock	
19	$\overline{CS}$	SPI port chip select	
RF, Mixer, IF Path			
4, 5	EXTVCOIN+, EXTVCOIN-	External VCO or LO inputs	DC block with 100 pF capacitors.
13, 14	LOOUT+, LOOUT-	Differential LO outputs	DC block with 100 pF capacitors.
22, 23	IFOUT2+, IFOUT2-	Channel 2 differential IF outputs	Bias to 5 V supply with 330 nH inductors and dc block with 150 pF capacitors.
25	RFBCT2	Internal mixer bias control for Channel 2 RF input	Decouple to GND with a 10 pF and a 10 nF capacitor, as close to the pin as possible.
26	RFIN2	Channel 2 single-ended RF input	DC block with a 22 pF capacitor.
36	RFBCT1	Internal mixer bias control for Channel 1 RF input	Decouple to GND with a 10 pF and a 10 nF capacitor, as close to the pin as possible.
35	RFIN1	Channel 1 single-ended RF input	DC block with a 22 pF capacitor.
38, 39	IFOUT1-, IFOUT1+	Channel 1 differential IF outputs	Bias to 5 V supply with 330 nH inductors and dc block with 150 pF capacitors.
PLL/VCO			
2	VCOVTUNE	Control voltage for internal VCO	Output from external loop filter.
43	REFIN	External reference for internal PLL	
47	CPOUT	Charge pump output	Input to external loop filter.
Other			
42	MUXOUT	Output for various internal analog signals, including PLL lock detect and voltage proportional to absolute temperature (VPTAT)	Can be read directly from the pin; the user must be careful of loading effects; not a low impedance output.
21, 40	DNC	Do not connect	

## MIXER OPTIMIZATION

### RF INPUT BALUN INSERTION LOSS OPTIMIZATION

At lower input frequencies, more capacitance is needed. This increase is achieved by programming higher codes into BAL\_COUT. At high frequencies, less capacitance is required; therefore, lower BAL\_COUT codes are appropriate.

As shown in Figure 112 and Figure 113, this tuning range can be further optimized by adding capacitance across the RF input in conjunction with tuning BAL\_COUT. This added capacitance can help to increase the low frequency range of the device significantly.

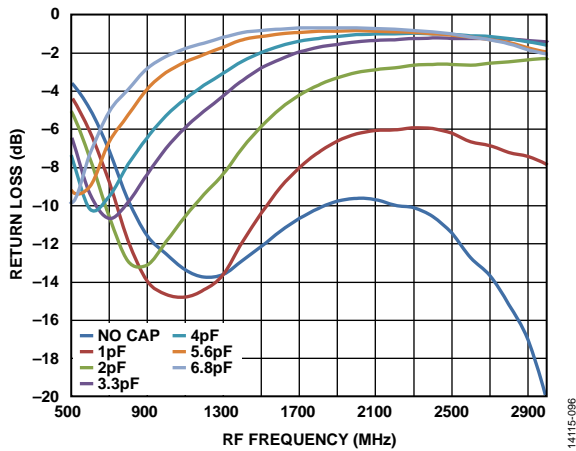

Figure 112. Return Loss; Optimum BAL\_COUT vs. RF Frequency for Various Tuning Capacitor Values on RFINx Using a High-Side LO

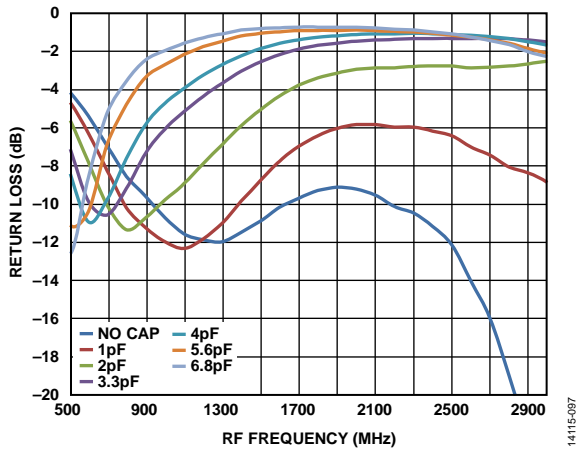

Figure 113. Return Loss; Optimum BAL\_COUT vs. RF Frequency for Various Tuning Capacitor Values on RFINx Using a Low-Side LO

### IIP3 OPTIMIZATION

In applications in which performance is critical, the ADRF6614 offers IIP3 optimization. The IF amplifier bias current can be reduced to trade performance vs. power consumption. This tradeoff saves on the overall power at the expense of degraded performance.

Figure 114 to Figure 117 show the IIP3 sweeps for all combinations of IFA main bias and linearity bias. The IIP3 vs. main bias and linearity bias figures show both a surface and a contour plot in one

figure. The contour plot is located directly underneath the surface plot. The best approach for reading the figure is to localize the peaks on the surface plot, which indicate maximum IIP3, and to follow the same color pattern to the contour plot to determine the optimized IFA main bias and linearity bias settings.

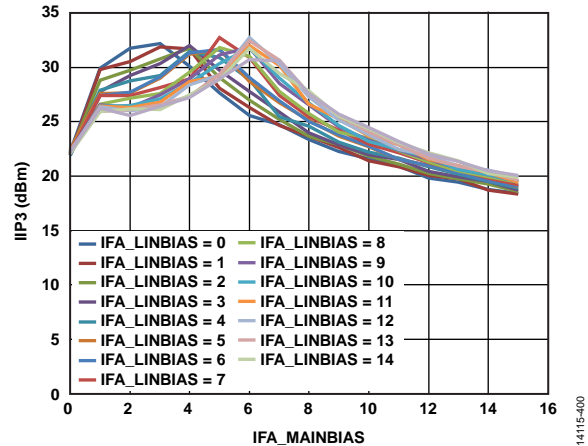

Figure 114. IIP3 vs. Main Bias (IFA\_MAINBIAS) and Linearity Bias (IFA\_LINBIAS) Level at IF Frequency = 50 MHz

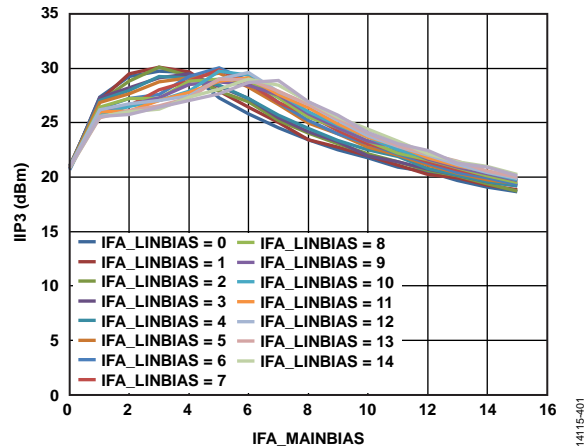

Figure 115. IIP3 vs. Main Bias (IFA\_MAINBIAS) and Linearity Bias (IFA\_LINBIAS) Level at IF Frequency = 100 MHz

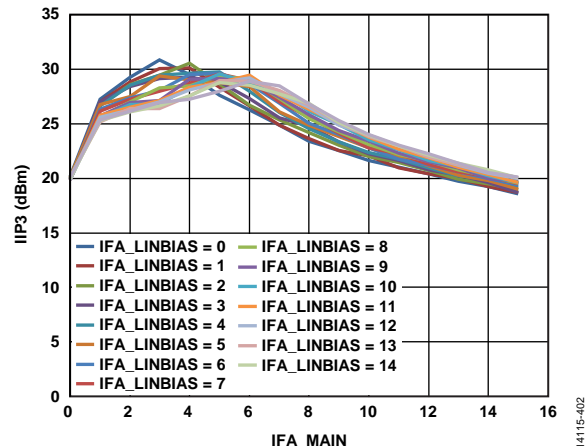

Figure 116. IIP3 vs. Main Bias (IFA\_MAINBIAS) and Linearity Bias (IFA\_LINBIAS) Level at IF Frequency = 150 MHz



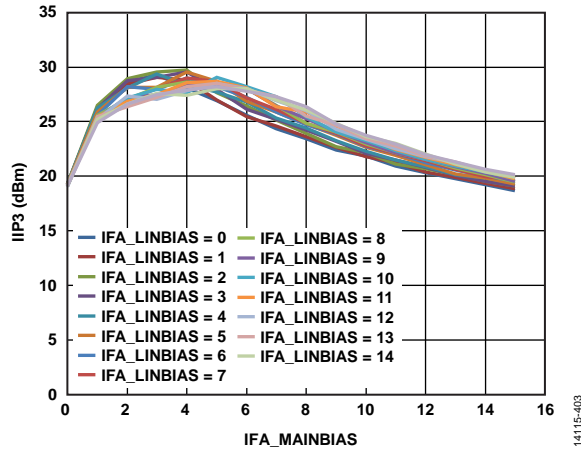

Figure 117. IIP3 vs. Main Bias (IFA\_MAINBIAS) and Linearity Bias (IFA\_LINBIAS) Level at IF Frequency = 200 MHz

### VGS PROGRAMMING

The ADRF6614 allows programmability for internal gate-to-source voltages (VGS) for optimizing mixer performance over the desired frequency bands. The ADRF6614 default VGS setting is 0. Both channels of the ADRF6614 are programmed together using the same VGS setting. Power conversion gain, input IP3, input P1dB, and SSB noise figure can be optimized, as shown in Figure 40, Figure 41, Figure 43, and Figure 44, respectively.

### LOW-PASS FILTER PROGRAMMING

The ADRF6614 allows programmability for the low-pass filter terminating the mixer output. This filter blocks sum term mixing products at the expense of some noise figure and gain and can significantly increase input IP3. The ADRF6614 default LPF setting is 0. Both channels of the ADRF6614 are programmed together using the same LPF settings. Power conversion gain, input P1dB, input IP3, and SSB noise figure can be optimized as shown in Figure 42, Figure 45, Figure 46, and Figure 49, respectively.

**Table 24. Recommended Optimum Settings for High Performance Mode (in Decimal)**

<b>RF Frequency (MHz)</b>	<b>LO Frequency (MHz)</b>	<b>IFA_MAINBIAS</b>	<b>IFA_LINBIAS</b>	<b>BAL_COUT</b>	<b>LPF</b>	<b>VGS</b>
700	497	5	11	14	4	0
800	597	5	11	14	4	0
900	697	5	11	10	4	0
1000	797	5	11	10	4	0
1100	897	5	15	10	4	0
1200	997	5	15	10	4	0
1300	1097	5	15	10	4	0
1400	1197	5	15	6	4	0
1500	1297	5	15	6	4	0
1600	1397	5	15	4	4	0
1700	1497	5	15	4	4	0
1800	1597	5	15	4	4	0
1900	1697	5	15	4	4	0
2000	1797	5	15	4	4	0
2100	1897	5	15	4	4	0
2200	1997	5	15	4	4	0
2300	2097	5	15	2	4	0
2400	2197	5	15	2	4	0
2500	2297	5	15	2	4	0
2600	2397	5	15	2	4	0
2700	2497	5	15	2	4	0
2800	2597	5	15	2	4	0
2900	2697	5	15	0	4	0
3000	2797	5	15	0	4	0

**Table 25. Recommended Optimum Settings for High Efficiency Mode (in Decimal)**

<b>RF Frequency (MHz)</b>	<b>LO Frequency (MHz)</b>	<b>IFA_MAINBIAS</b>	<b>IFA_LINBIAS</b>	<b>BAL_COUT</b>	<b>LPF</b>	<b>VGS</b>
700	497	5	15	14	4	0
800	597	5	15	14	4	0
900	697	5	15	10	4	0
1000	797	5	15	10	4	0
1100	897	5	15	10	4	0
1200	997	5	15	10	4	0
1300	1097	5	15	10	4	0
1400	1197	7	15	6	4	0
1500	1297	7	15	6	4	0
1600	1397	7	15	4	4	0
1700	1497	7	15	4	4	0
1800	1597	7	15	4	4	0
1900	1697	7	15	4	4	0
2000	1797	7	15	4	4	0
2100	1897	7	15	4	4	0
2200	1997	7	15	4	4	0
2300	2097	13	15	2	4	0
2400	2197	13	15	2	4	0
2500	2297	13	15	2	4	0
2600	2397	13	15	2	4	0
2700	2497	13	15	2	4	0
2800	2597	13	15	2	4	0
2900	2697	13	15	0	4	0
3000	2797	13	15	0	4	0

**GSM MODE OF OPERATION**

The ADRF6614 supports GSM phase noise specifications in typical GSM bands such as the 800 MHz, 900 MHz, 1800 MHz, and 1900 MHz. GSM phase noise performance in the 800 MHz and 900 MHz bands is met by simply tuning the integrated PLLVCO to the desired frequency.

Integrated VCO cores (VCO\_4 and VCO\_5) support GSM phase noise performance in the 1800 MHz and 1900 MHz GSM bands. To ensure that GSM phase noise performance is achieved when using the ADRF6614 in 1800 MHz or 1900 MHz bands, select the VCO\_4 core by writing the VCO\_SEL bits in the VCO\_CTRL1 register (Register 0x22, Bits[2:0]) for a frequency range of 1.525 GHz to 1.547 GHz, and the VCO\_5 core for a frequency range of 1.668 GHz to 1.708 GHz.

The VCO\_4 and VCO\_5 cores operate at fundamental frequencies of 3.050 GHz to 3.094 GHz and 3.336 GHz to 3.416 GHz, respectively. To generate the desired LO frequency in the 1800 MHz and 1900 MHz bands, enable divide by 2 by writing to LO\_DIV (Register 0x22, Bits[5:3]).

For the GSM mode of operation, the recommended loop filter components and dynamic loop settings are shown in Table 19 at the PFD rate of 1.536 MHz.

See Figure 118 for the GSM mode phase noise performance of -145 dBc/Hz at 800 kHz offset at the carrier frequency of 1.535 GHz.

When using the VCO\_4 or VCO\_5 cores, it is required to set VTUNE\_DAC\_SLOPE (Register 0x49, Bits[13:9]) = 9d, VTUNE\_DAC\_OFFSET (Register 0x49, Bits[8:0]) = 171d, VCO\_LDO\_R2 (Register 0x22, Bits[11:8]) = 2d, and VCO\_LDO\_R4 (Register 0x22, Bits[15:12]) = 10d. In transitioning from a GSM VCO (VCO\_4 and VCO\_5) to an octave VCO, the LDO settings must be changed before changing the VCO selection.

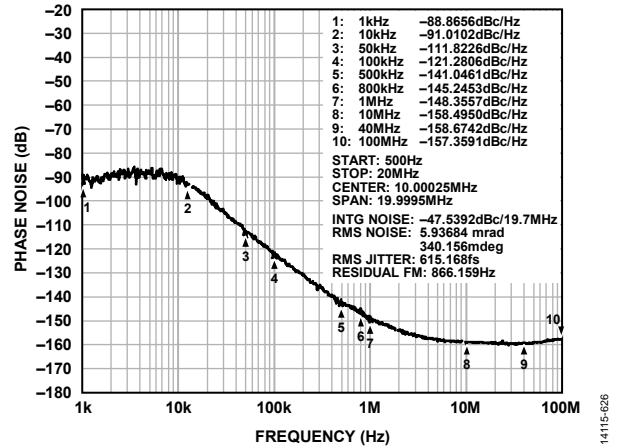

Figure 118. GSM Phase Noise Performance at 1.535 GHz

## REGISTER SUMMARY

Table 26. Register Summary

Reg.	Name	Bits	Bit 7	Bit 6	Bit 5	Bit 4	Bit 3	Bit 2	Bit 1	Bit 0	Reset	RW	
0x00	SOFT_RESET	[15:8] [7:0]	SOFT_RESET[15:8] SOFT_RESET[7:0]								0x0000	R	
0x01	ENABLES	[15:8] [7:0]	LO_LDO_EN	LO2_ENP	BALUN_EN	LO1_ENP	DIV2P5_EN	PWRUPRX	LO_PATH_EN		0x0000	RW	
			LO_DRV_EN	VCOBUF_LDO_EN	REF_BUF_EN	VCO_EN	DIV_EN	CP_EN	VCO_LDO_EN	LDO_3P3_EN			
0x02	INT_DIV	[15:8] [7:0]	DIV_MODE	INT_DIV[14:8] INT_DIV[7:0]								0x0058	RW
0x03	FRAC_DIV	[15:8] [7:0]	FRAC_DIV[15:8] FRAC_DIV[7:0]								0x0250	RW	
0x04	MOD_DIV	[15:8] [7:0]	MOD_DIV[15:8] MOD_DIV[7:0]								0x0600	RW	
0x10	IF_BIAS	[15:8] [7:0]	IFA_LIN_HIEFFP	IFA_MAIN_HIEFFP	IFA_LINSLOPE		IFA_MAINSLOPE		IFA_LINBIAS[3:2]		0x02B5	RW	
			IFA_LINBIAS[1:0]		IFA_LINBIAS_EN	IFA_MAINBIAS		IFA_MAINBIAS_EN					
0x20	CP_CTRL	[15:8] [7:0]	UNUSED				CSCALE				0x0026	RW	
			BLEED_POLARITY	BLEED									
0x21	PFD_CTRL1	[15:8] [7:0]	UNUSED	REF_MUX_SEL	PFD_POLARITY	REFSEL[11:8] REFSEL[7:0]				0x0003	RW		
0x22	VCO_CTRL1	[15:8] [7:0]	VCO_LDO_R4				VCO_LDO_R2				0x000A	RW	
			LO_DRV_LVL	LO_DIV		VCO_SEL							
0x30	BALUN_CTRL	[15:8] [7:0]	UNUSED			VGS			LPF			0x0000	RW
			BAL_COUT			RESERVED							
0x40	PFD_CTRL2	[15:8] [7:0]	UNUSED						ABLDLY[3] ABLDLY[2:0]		0x0010	RW	
			CPCTRL			CLKEDGE							
0x42	DITH_CTRL1	[15:8] [7:0]	UNUSED[11:4] UNUSED[3:0]				DITH_EN	DITH_MAG	DITH_VAL_H		0x000E	RW	
0x43	DITH_CTRL2	[15:8] [7:0]	DITH_VAL_L[15:8] DITH_VAL_L[7:0]								0x0001	RW	
0x44	SYNTH_FCNTN_CTRL	[15:8] [7:0]	UNUSED[9:2] UNUSED[1:0]		DIV_SDM_DIS	VCOCNT_CG_DIS	BANDCAL_CG_DIS	SDM_CG_DIS	SDM_DIVD_CLR	BANDCAL_DIVD_CLR	0x0000	RW	
0x45	VCO_CTRL2	[15:8] [7:0]	UNUSED				VCO_BAND_SRC				0x0020	RW	
			BAND										
0x46	VCO_CTRL3	[15:8] [7:0]	UNUSED								0x0000	RW	
			VCO_CNTR_DONE	VCO_BAND									
0x47	VCO_CNTR_CTRL	[15:8] [7:0]	UNUSED[11:4] UNUSED[3:0]				VCO_CNTR_REFCNT		VCO_CNTR_CLR	VCO_CNTR_EN		0x0000	RW
0x48	VCO_CNTR_RB	[15:8] [7:0]	VCO_CNTR_RB[15:8] VCO_CNTR_RB[7:0]								0x0000	R	
0x49	VTUNE_DAC_CTRL	[15:8] [7:0]	UNUSED			VTUNE_DAC_SLOPE				VTUNE_DAC_OFFSET[8]		0x0000	RW
			VTUNE_DAC_OFFSET[7:0]										
0x4A	VCO_BUF_LDO	[15:8] [7:0]	UNUSED				VCOBUF_LDO_R4				VCOBUF_LDO_R2	0x0000	RW

## REGISTER DETAILS

Address: 0x00, Reset: 0x0000, Name: SOFT\_RESET

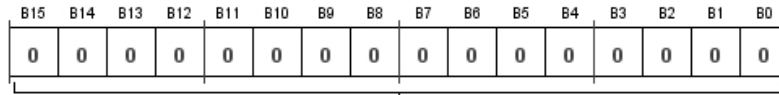

[15:0] SOFT\_RESET (R)  
SOFT RESET

0: any write to this register will assert soft reset command

Table 27. Bit Descriptions for SOFT\_RESET

Bits	Bit Name	Settings	Description	Reset	Access
[15:0]	SOFT_RESET	0	Soft reset bit. Any write to this register asserts a soft reset command.	0x0 0x0	R R

Address: 0x01, Reset: 0x0000, Name: ENABLES

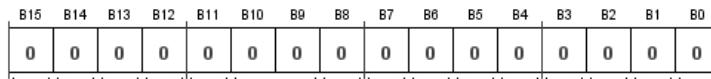

[15] LO\_LDO\_EN (RW)  
Power up LO LDO

[14] LO2\_ENP (RW)  
LO 2 enable

[13] BALUN\_EN (RW)  
Input Balun enable

[12] LO1\_ENP (RW)  
LO 1 enable

[11] DIV2P5\_EN (RW)  
enable dividers 2.5V LDO

[10:9] PWRUPRX (RW)  
Power up Rx  
0x0: Power down both mixer channels  
0x1: Power up mixer channel 1  
0x2: Power up mixer channel 2  
0x3: Power up both mixer channels

[8] LO\_PATH\_EN (RW)  
External LO path enable

[0] LDO\_3P3\_EN (RW)  
Power up 3.3V LDO

[1] VCO\_LDO\_EN (RW)  
Power up VCO LDO

[2] CP\_EN (RW)  
Power up charge pump

[3] DIV\_EN (RW)  
Power up dividers

[4] VCO\_EN (RW)  
Power up VCOs

[5] REF\_BUF\_EN (RW)  
Reference buffer enable

[6] VCOBUF\_LDO\_EN (RW)  
VCO buffer LDO enable

[7] LO\_DRV\_EN (RW)  
LO driver enable

Table 28. Bit Descriptions for ENABLES

Bits	Bit Name	Settings	Description	Reset	Access
15	LO_LDO_EN		Power up LO LDO.	0x0	RW
14	LO2_ENP		LO 2 enable.	0x0	RW
13	BALUN_EN		Input balun enable.	0x0	RW
12	LO1_ENP		LO 1 enable.	0x0	RW
11	DIV2P5_EN		Enable dividers 2.5 V LDO.	0x0	RW
[10:9]	PWRUPRX	0x0 0x1 0x2 0x3	Power up Rx. Power down both mixer channels. Power up mixer Channel 1. Power up mixer Channel 2. Power up both mixer channels.	0x0	RW
8	LO_PATH_EN		External LO path enable.	0x0	RW
7	LO_DRV_EN		LO driver enable.	0x0	RW

Bits	Bit Name	Settings	Description	Reset	Access
6	VCOBUF_LDO_EN		VCO buffer LDO enable.	0x0	RW
5	REF_BUF_EN		Reference buffer enable.	0x0	RW
4	VCO_EN		Power up VCOs.	0x0	RW
3	DIV_EN		Power up dividers.	0x0	RW
2	CP_EN		Power up charge pump.	0x0	RW
1	VCO_LDO_EN		Power up VCO LDO.	0x0	RW
0	LDO_3P3_EN		Power up 3.3 V LDO.	0x0	RW

Address: 0x02, Reset: 0x0058, Name: INT\_DIV

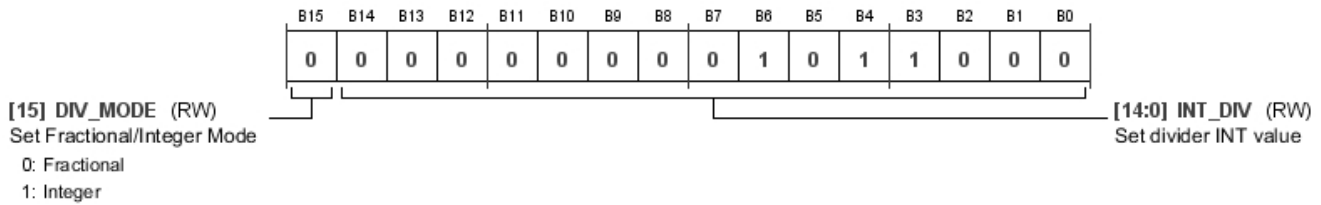

Table 29. Bit Descriptions for INT\_DIV

Bits	Bit Name	Settings	Description	Reset	Access
15	DIV_MODE	0 1	Set fractional/integer mode. Fractional. Integer.	0x0	RW
[14:0]	INT_DIV		Set divider INT value.	0x58	RW

Address: 0x03, Reset: 0x0250, Name: FRAC\_DIV

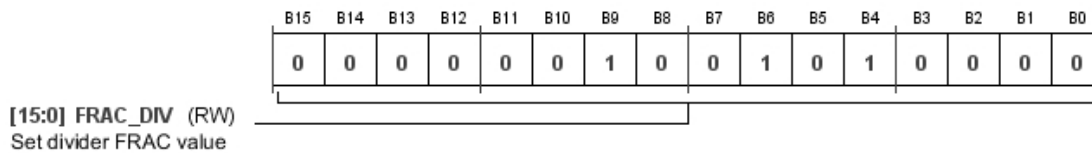

Table 30. Bit Descriptions for FRAC\_DIV

Bits	Bit Name	Settings	Description	Reset	Access
[15:0]	FRAC_DIV		Set divider FRAC value.	0x250	RW

Address: 0x04, Reset: 0x0600, Name: MOD\_DIV



Table 31. Bit Descriptions for MOD\_DIV

Bits	Bit Name	Settings	Description	Reset	Access
[15:0]	MOD_DIV		Set divider MOD value.	0x600	RW

Address: 0x10, Reset: 0x02B5, Name: IF\_BIAS

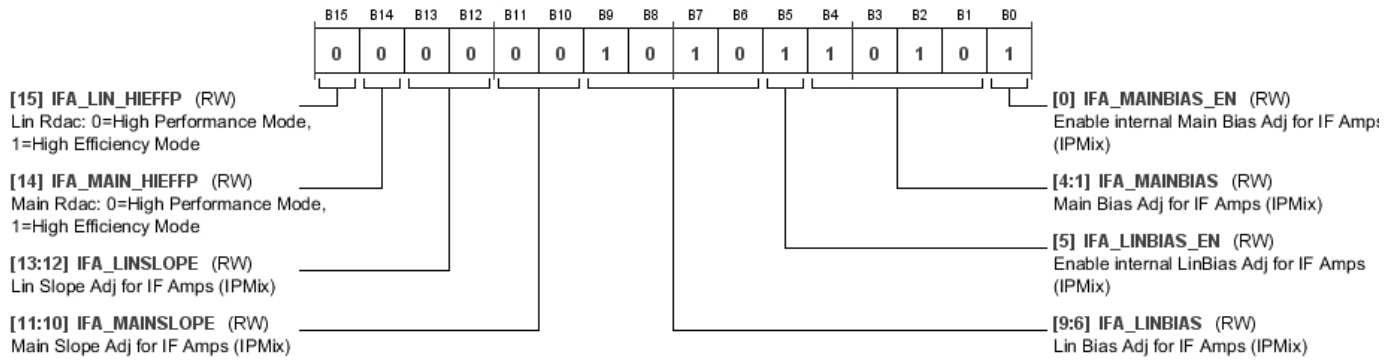

Table 32. Bit Descriptions for IF\_BIAS

Bits	Bit Name	Settings	Description	Reset	Access
15	IFA_LIN_HIEFFP	0 1	Linearity RDAC. High performance mode. High efficiency mode.	0x0	RW
14	IFA_MAIN_HIEFFP	0 1	Main RDAC. High performance mode. High efficiency mode.	0x0	RW
[13:12]	IFA_LINSLOPE		Linearity slope adjust for IF amps (IPMix).	0x0	RW
[11:10]	IFA_MAINSLOPE		Main slope adjust for IF amps (IPMix).	0x0	RW
[9:6]	IFA_LINBIAS		Linearity bias adjust for IF amps (IPMix).	0xa	RW
5	IFA_LINBIAS_EN		Enable internal linearity bias adjust for IF amps (IPMix).	0x1	RW
[4:1]	IFA_MAINBIAS		Main bias adjust for IF amps (IPMix).	0xa	RW
0	IFA_MAINBIAS_EN		Enable internal main bias adjust for IF amps (IPMix).	0x1	RW

Address: 0x20, Reset: 0x0026, Name: CP\_CTRL

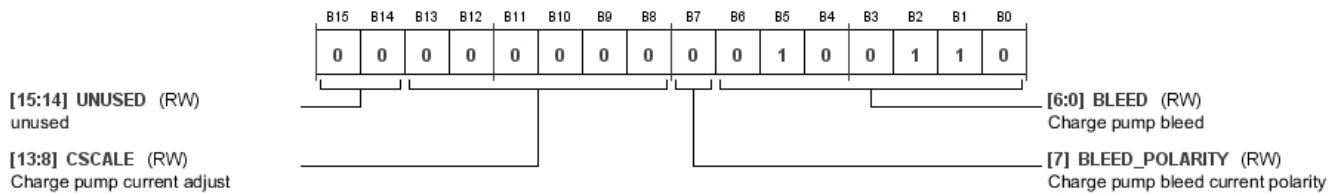

Table 33. Bit Descriptions for CP\_CTRL

Bits	Bit Name	Settings	Description	Reset	Access
[15:14]	UNUSED		Unused.	0x0	RW
[13:8]	CSCALE		Charge pump current adjust.	0x0	RW
7	BLEED_POLARITY		Charge pump bleed current polarity.	0x0	RW
[6:0]	BLEED		Charge pump bleed.	0x26	RW

Address: 0x21, Reset: 0x0003, Name: PFD\_CTRL1

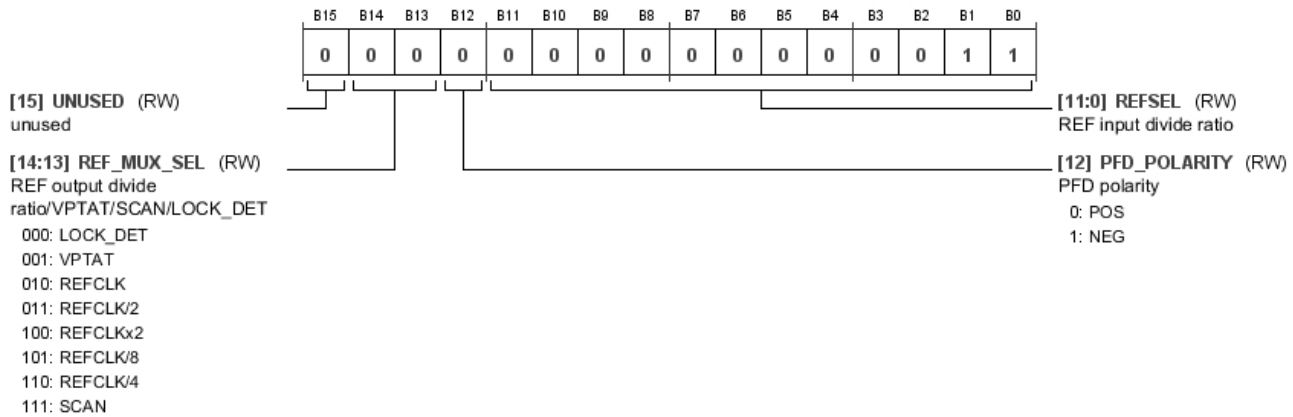

Table 34. Bit Descriptions for PFD\_CTRL1

Bits	Bit Name	Settings	Description	Reset	Access
15	UNUSED		Unused.	0x0	RW
[14:13]	REF_MUX_SEL	000 001 010 011 100 101 110 111	Reference output divide ratio/VPTAT/SCAN/LOCK_DET. LOCK_DET. VPTAT. REFCLK. REFCLK/2. REFCLK × 2. REFCLK/8. REFCLK/4. SCAN.	0x0	RW
12	PFD_POLARITY	0 1	PFD polarity. Positive. Negative.	0x0	RW
[11:0]	REFSEL		Reference input divide ratio.	0x3	RW



Address: 0x22, Reset: 0x000A, Name: VCO\_CTRL1

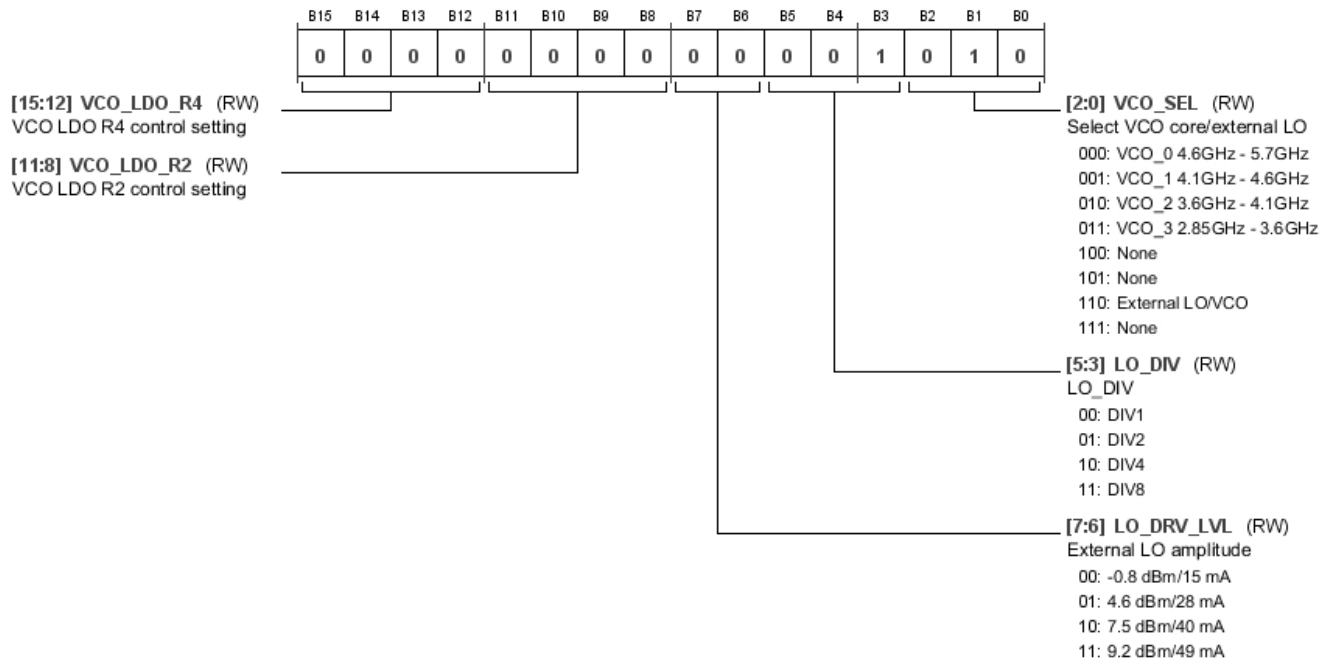

Table 35. Bit Descriptions for VCO\_CTRL1

Bits	Bit Name	Settings	Description	Reset	Access
[15:12]	VCO_LDO_R4		VCO LDO R4 resistor control setting.	0x0	RW
[11:8]	VCO_LDO_R2		VCO LDO R2 resistor control setting.	0x0	RW
[7:6]	LO_DRV_LVL	00 -0.8 dBm/15 mA. 01 4.6 dBm/28 mA. 10 7.5 dBm/40 mA. 11 9.2 dBm/49 mA.	External LO amplitude.	0x0	RW
[5:3]	LO_DIV	00 Divide by 1. 01 Divide by 2. 10 Divide by 4. 11 Divide by 8.	LO divider.	0x1	RW
[2:0]	VCO_SEL	000 VCO_0 4.6 GHz to 5.7 GHz. 001 VCO_1 4.02 GHz to 4.6 GHz. 010 VCO_2 3.5 GHz to 4.02 GHz. 011 VCO_3 2.85 GHz to 3.5 GHz. 100 VCO_4 3.050 GHz to 3.094 GHz 101 VCO_5 3.336 GHz to 3.416 GHz 110 External LO/VCO. 111 None	Select VCO core/external LO.	0x2	RW

Address: 0x30, Reset: 0x0000, Name: BALUN\_CTRL

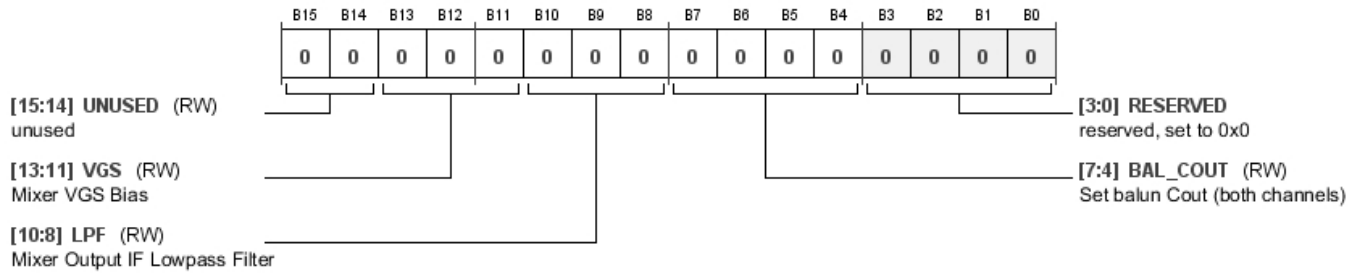

Table 36. Bit Descriptions for BALUN\_CTRL

Bits	Bit Name	Settings	Description	Reset	Access
[15:14]	UNUSED		Unused.	0x0	RW
[13:11]	VGS		Mixer VGS bias.	0x0	RW
[10:8]	LPF		Mixer output IF low-pass filter.	0x0	RW
[7:4]	BAL_COUT		Set balun C <sub>OUT</sub> (both channels).	0x0	RW
[3:0]	RESERVED		Reserved, set to 0x0.	0x0	RW

Address: 0x40, Reset: 0x0010, Name: PFD\_CTRL2

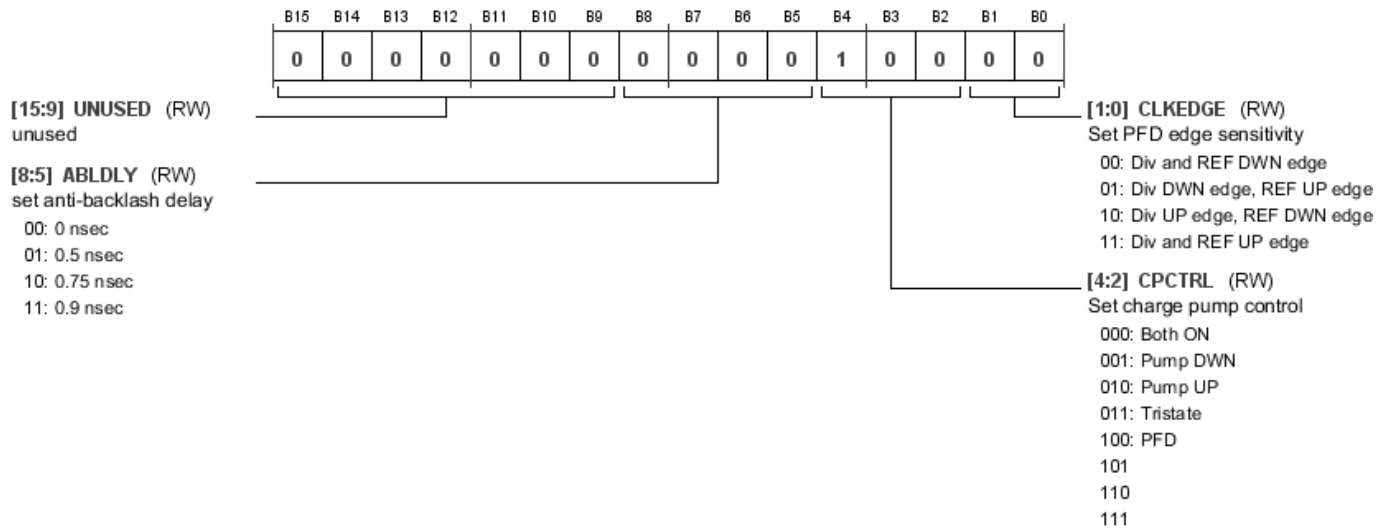

Table 37. Bit Descriptions for PFD\_CTRL2

Bits	Bit Name	Settings	Description	Reset	Access
[15:9]	UNUSED		Unused.	0x0	RW
[8:5]	ABLDLY	00 01 10 11	Set antibacklash delay. 0 ns. 0.5 ns. 0.75 ns. 0.9 ns.	0x0	RW

Bits	Bit Name	Settings	Description	Reset	Access
[4:2]	CPCTRL	000 Both on. 001 Pump down. 010 Pump up. 011 Tristate. 100 PFD. 101 Unused. 110 Unused. 111 Unused.	Set charge pump control.	0x4	RW
[1:0]	CLKEDGE	00 Divider and reference down edge. 01 Divider down edge, reference up edge. 10 Divider up edge, reference down edge. 11 Divider and reference up edge.	Set PFD edge sensitivity.	0x0	RW

Address: 0x42, Reset: 0x000E, Name: DITH\_CTRL1

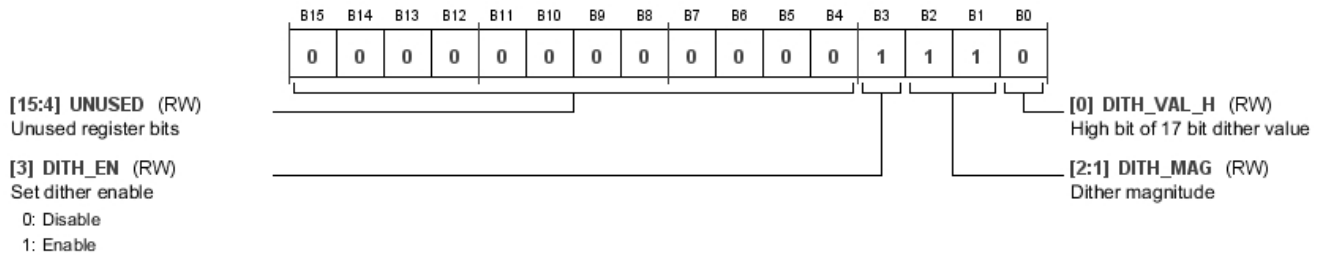

Table 38. Bit Descriptions for DITH\_CTRL1

Bits	Bit Name	Settings	Description	Reset	Access
[15:4]	UNUSED		Unused register bits.	0x0	RW
3	DITH_EN	0 Disable. 1 Enable.	Set dither enable.	0x1	RW
[2:1]	DITH_MAG		Dither magnitude.	0x3	RW
0	DITH_VAL_H		Highest bit of 17-bit dither value.	0x0	RW

Address: 0x43, Reset: 0x0001, Name: DITH\_CTRL2

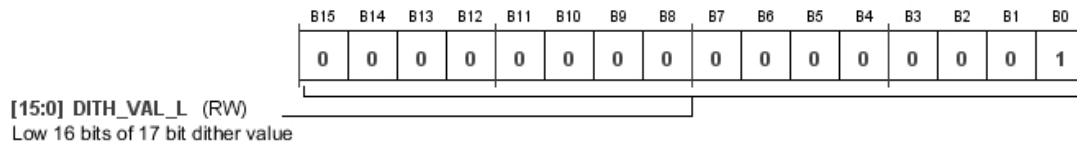
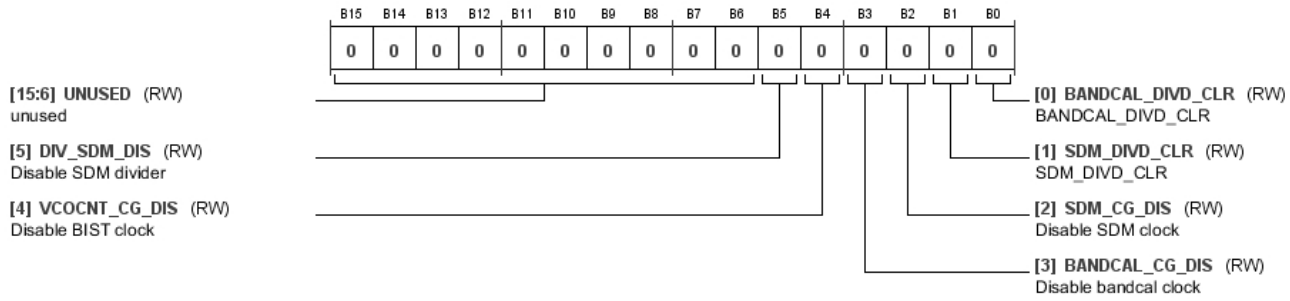

Table 39. Bit Descriptions for DITH\_CTRL2

Bits	Bit Name	Settings	Description	Reset	Access
[15:0]	DITH_VAL_L		Lowest 16 bits of 17-bit dither value.	0x1	RW

Address: 0x44, Reset: 0x0000, Name: SYNTH\_FCNTN\_CTRL



**Table 40. Bit Descriptions for SYNTH\_FCNTN\_CTRL**

Bits	Bit Name	Settings	Description	Reset	Access
[15:6]	UNUSED		Unused.	0x0	RW
5	DIV_SDM_DIS		Disable sigma-delta modulator (SDM) divider.	0x0	RW
4	VCOCNT_CG_DIS		Disable built in self test (BIST) clock.	0x0	RW
3	BANDCAL_CG_DIS		Disable VCO band calibration (BANDCAL) clock.	0x0	RW
2	SDM_CG_DIS		Disable SDM clock.	0x0	RW
1	SDM_DIVD_CLR		Clear SDM divider.	0x0	RW
0	BANDCAL_DIVD_CLR		Clear BANDCAL divider.	0x0	RW

Address: 0x45, Reset: 0x0020, Name: VCO\_CTRL2

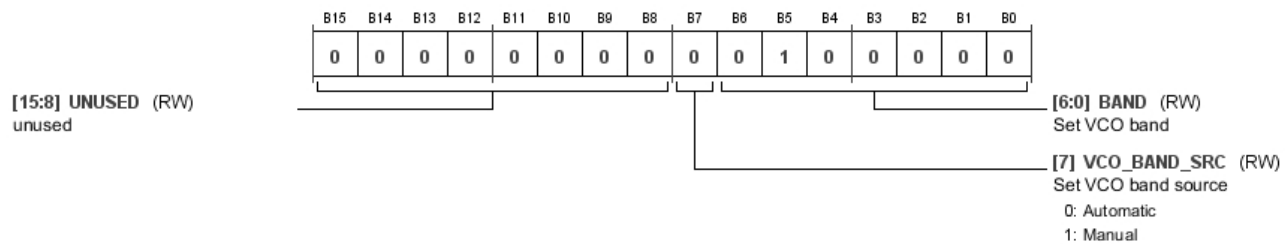

**Table 41. Bit Descriptions for VCO\_CTRL2**

Bits	Bit Name	Settings	Description	Reset	Access
[15:8]	UNUSED		Unused.	0x0	RW
7	VCO_BAND_SRC	0 1	Set VCO band source. Automatic Manual	0x0	RW
[6:0]	BAND		Set VCO band.	0x20	RW

Address: 0x46, Reset: 0x0000, Name: VCO\_CTRL3

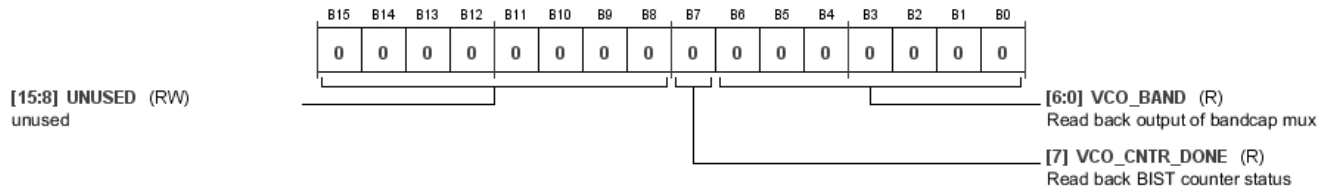

Table 42. Bit Descriptions for VCO\_CTRL3

Bits	Bit Name	Settings	Description	Reset	Access
[15:8]	UNUSED		Unused.	0x0	RW
7	VCO_CNTR_DONE		Read back BIST counter status.	0x0	R
[6:0]	VCO_BAND		Read back output of band capacitor mux.	0x0	R

Address: 0x47, Reset: 0x0000, Name: VCO\_CNTR\_CTRL

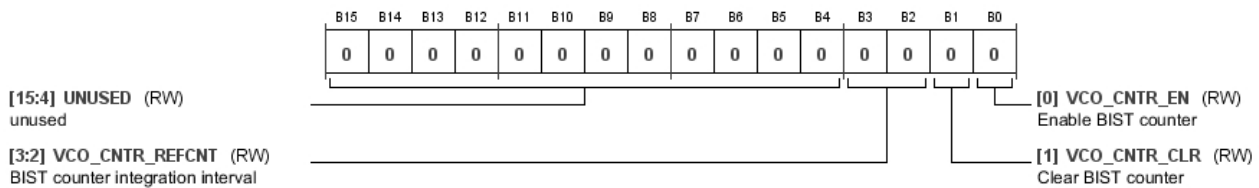

Table 43. Bit Descriptions for VCO\_CNTR\_CTRL

Bits	Bit Name	Settings	Description	Reset	Access
[15:4]	UNUSED		Unused.	0x0	RW
[3:2]	VCO_CNTR_REFCNT		BIST counter integration interval.	0x0	RW
1	VCO_CNTR_CLR		Clear BIST counter.	0x0	RW
0	VCO_CNTR_EN		Enable BIST counter.	0x0	RW

Address: 0x48, Reset: 0x0000, Name: VCO\_CNTR\_RB

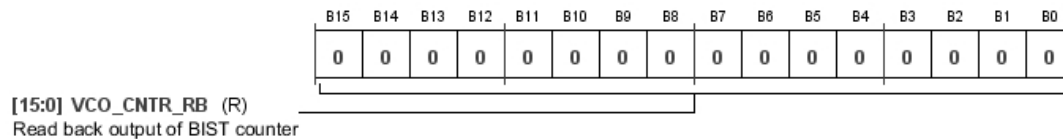

Table 44. Bit Descriptions for VCO\_CNTR\_RB

Bits	Bit Name	Settings	Description	Reset	Access
[15:0]	VCO_CNTR_RB		Read back output of BIST counter.	0x0	R

Address: 0x49, Reset: 0x0000, Name: VTUNE\_DAC\_CTRL

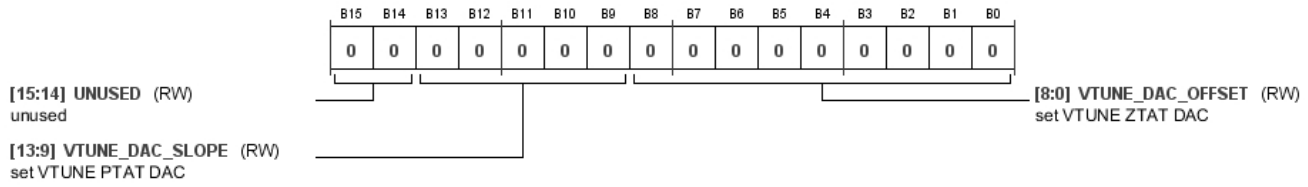

Table 45. Bit Descriptions for VTUNE\_DAC\_CTRL

Bits	Bit Name	Settings	Description	Reset	Access
[15:14]	UNUSED		Unused.	0x0	RW
[13:9]	VTUNE_DAC_SLOPE		Set $V_{TUNE}$ proportional to absolute temperature (PTAT) DAC.	0x0	RW
[8:0]	VTUNE_DAC_OFFSET		Set $V_{TUNE}$ zero to absolute temperature (ZTAT) DAC.	0x0	RW

Address: 0x4A, Reset: 0x0000, Name: VCO\_BUF\_LDO

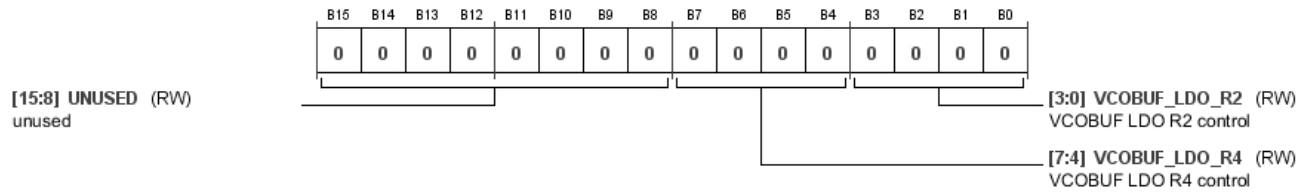

Table 46. Bit Descriptions for VCO\_BUF\_LDO

Bits	Bit Name	Settings	Description	Reset	Access
[15:8]	UNUSED		Unused.	0x0	RW
[7:4]	VCOBUF_LDO_R4		VCOBUF LDO R4 control.	0x0	RW
[3:0]	VCOBUF_LDO_R2		VCOBUF LDO R2 control.	0x0	RW

## EVALUATION BOARD

An evaluation board is available for the [ADRF6614](#). The standard evaluation board schematic is presented in Figure 119. The USB interface circuitry schematic is presented in Figure 121 and/or Figure 120. The evaluation board layout is shown in Figure 122

and Figure 123. The evaluation board is fabricated using Rogers® 3003 material. Table 47 details the configuration for the mixer characterization. The evaluation board software is available on [www.analog.com](http://www.analog.com).

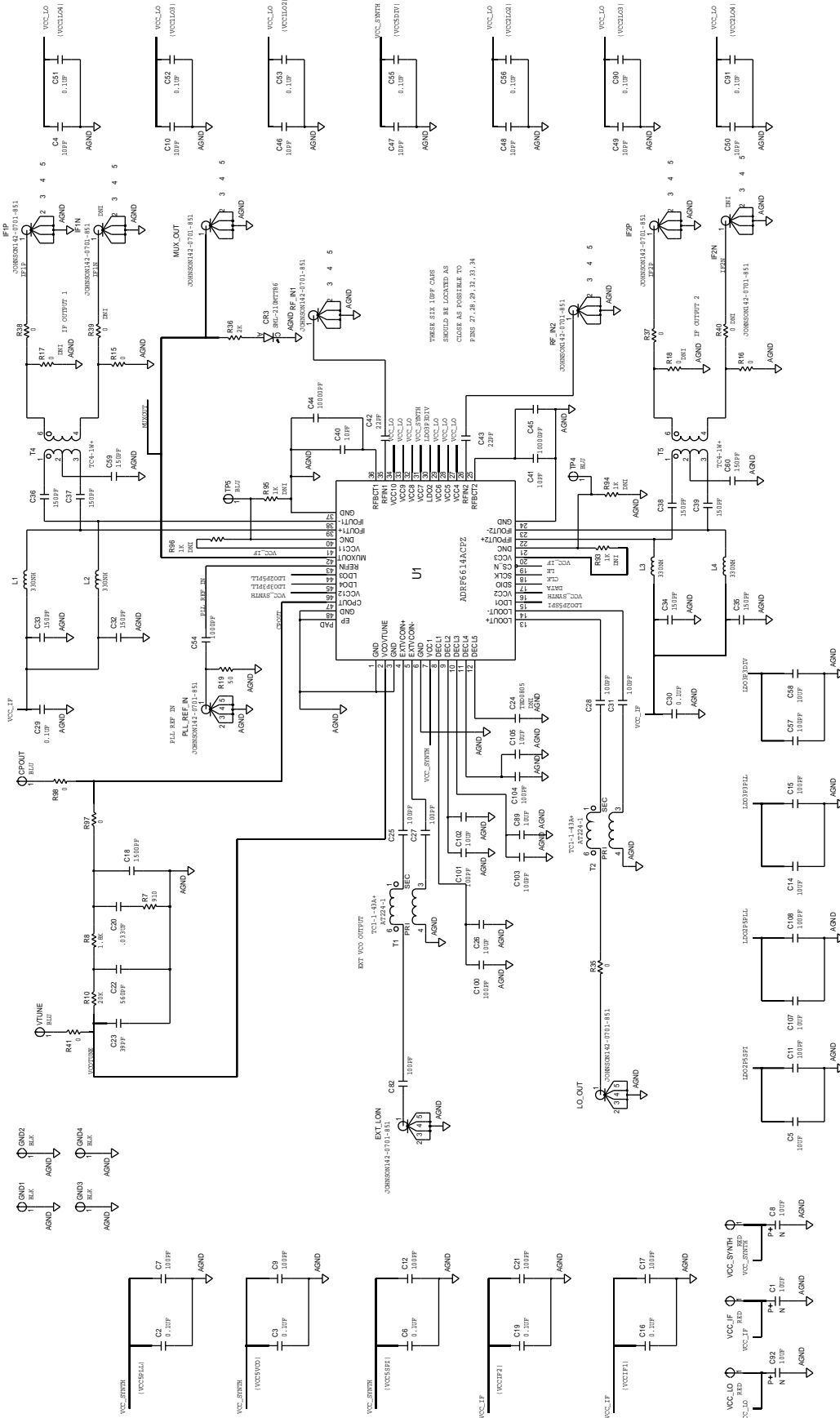

ALL 100PF ENDOFFLINE CAPS SHOULD BE AS CLOSE AS POSSIBLE TO THE PINS ON THE CHIP

Figure 119. Evaluation Board, Main Circuitry  
Rev. 0 | Page 56 of 61





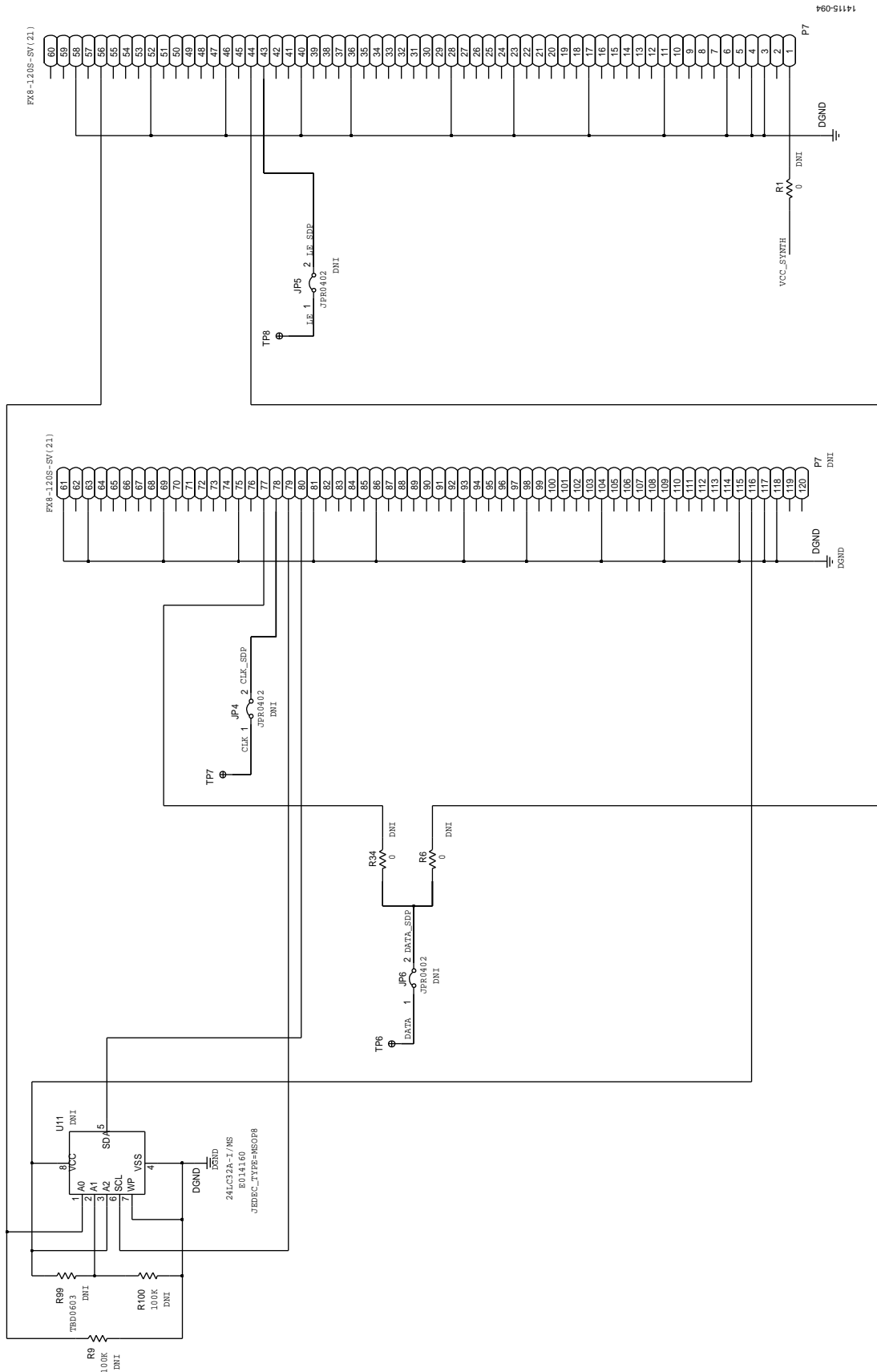

Figure 121. Evaluation Board, Analog Devices, Inc. SDP-5 USB Interface

Table 47. Evaluation Board Bill of Materials

Components	Description	Default Conditions
C1, C2, C8, C11, C12, C13, C14, C15, C18, C19, C20, C23, C26, C27	Power supply decoupling. Nominal supply decoupling consists of a 0.1 $\mu$ F capacitor to ground in parallel with a 10 pF capacitor to ground positioned as close to the device as possible.	C1, C2, C26, C27 = 0.1 $\mu$ F (size 0402) C8, C11, C12, C13, C14, C15, C18, C19 C20, C23 = 10 pF (size 0402)
C6, C7, C24, C25	RF input interface. The input channels are ac-coupled through C6 and C24. C7 and C25 provide bypassing for the center tap of the RF input baluns.	C6, C24 = 22 pF (size 0402) C7, C25 = 22 pF (size 0402)
C3, C4, C5, C28, C29, C30, L1, L2, L3, L4, R20, R21, R22, R23, T1, T2	IF output interface. The open-collector IF output interfaces are biased through pull-up choke Inductors L1, L2, L3, and L4. T1 and T2 are 4:1 impedance transformers used to provide single-ended IF output interfaces, with C5 and C30 providing center tap bypassing. Remove R21 and R22 for balanced output operation.	C3, C4, C5, C28, C29, C30 = 120 pF (size 0402) L1, L2, L3, L4 = 470 nH (size 0603) R20, R23 = open R21, R22 = 0 $\Omega$ (size 0402) T1, T2 = TC4-1W+ (Mini-Circuits®)
C17	LO interface. C17 provides ac coupling for the local oscillator input.	C17 = 22 pF (size 0402)
R1, R2	Bias control. R1 and R2 set the bias point for the internal IF amplifier.	R1, R2 = 910 $\Omega$ (size 0402)

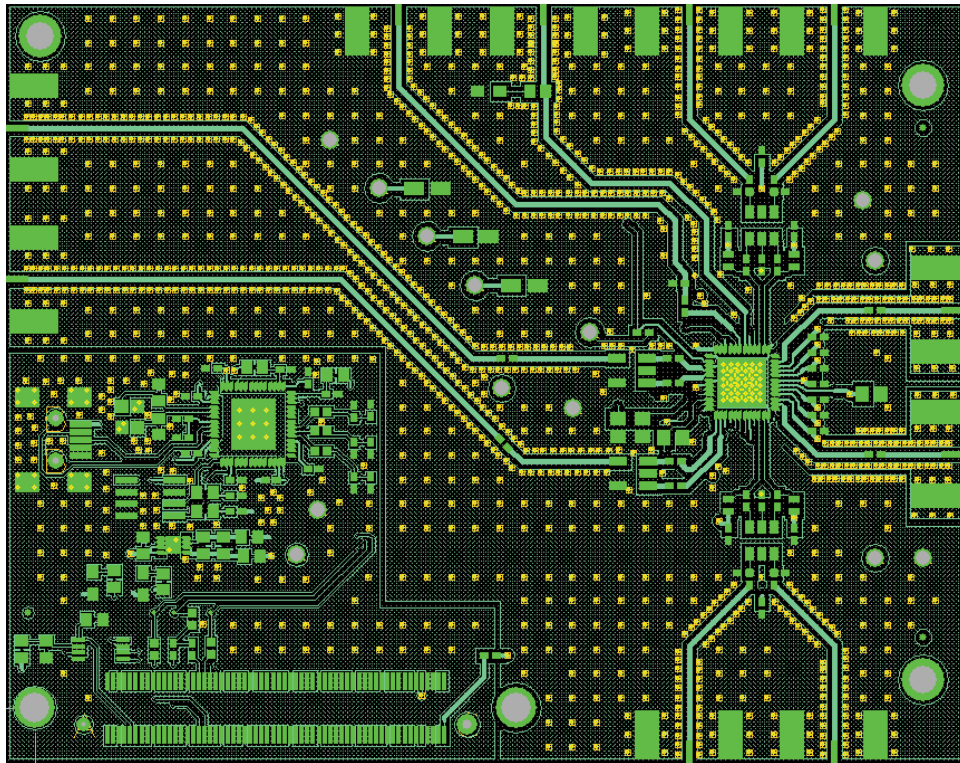
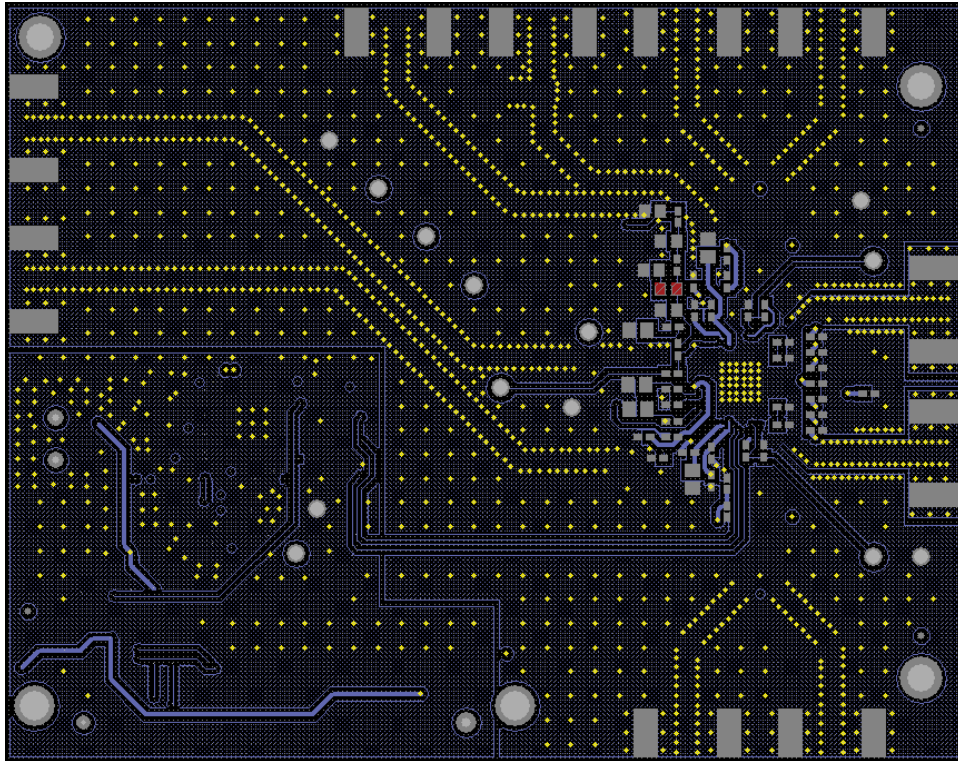

Figure 122. Evaluation Board, Top Layer

14115-205



14115-206

Figure 123. Evaluation Board, Bottom Layer

## OUTLINE DIMENSIONS

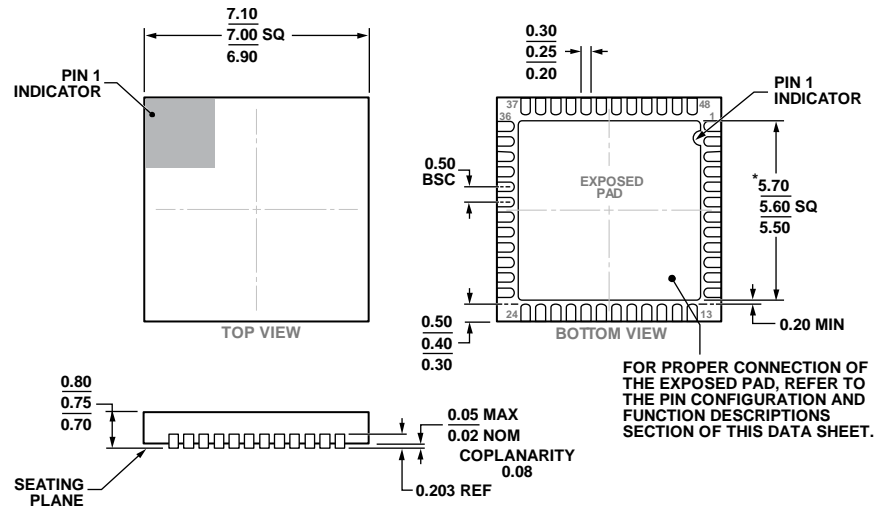

\*COMPLIANT TO JEDEC STANDARDS MO-220-WKGD-2 WITH THE EXCEPTION OF THE EXPOSED PAD DIMENSION.

Figure 124. 48-Lead Lead Frame Chip Scale Package [LFCSP]  
7 mm × 7 mm Body and 0.75 mm Package Height  
(CP-48-13)  
Dimensions shown in millimeters

10-24-2013-0

## ORDERING GUIDE

Model <sup>1</sup>	Temperature Range	Package Description	Package Option
ADRF6614ACPZ-R7	-40°C to +85°C	48-Lead Lead Frame Chip Scale Package [LFCSP]	CP-48-13
ADRF6614-EVALZ		Evaluation Board	

<sup>1</sup> Z = RoHS Compliant Part.