



## GaAs HBT HIGH LINEARITY PUSH-PULL AMPLIFIER, 75 Ohm, DC - 1 GHz

### Typical Applications

The HMC754S8GE is ideal for:

- CATV / Broadband Infrastructure
- Test & Measurement Equipment
- Line Amps and Fiber Nodes
- Customer Premise Equipment

### Features

- Output IP2: +78 dBm
- High Gain: 14.5 dB
- High Output IP3: +38 dBm
- 75 Ohm Impedance
- Single Positive Supply: +5V
- Robust 1000V ESD, Class 1C
- SOIC-8 SMT Package

### Functional Diagram

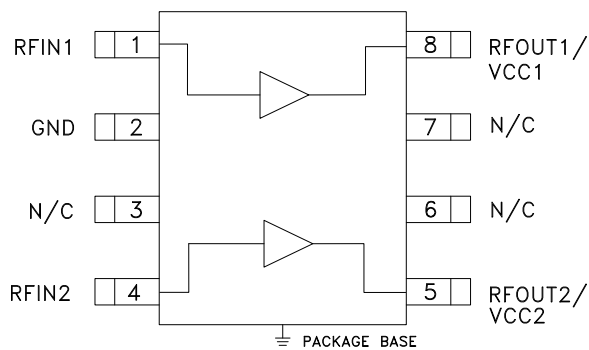

### General Description

The HMC754S8GE is a GaAs/InGaP HBT Dual Channel Gain Block MMIC SMT amplifier covering DC to 1 GHz. This versatile product contains two gain blocks, packaged in a single 8 lead plastic SOIC-8, for use with both amplifiers combined in push-pull configuration using external baluns to cancel out second order non-linearities and improve IP2 performance. In this configuration, the HMC754S8GE offers high gain, very low distortion & simple external matching. This high linearity amplifier consumes only 160mA from a single positive supply.

### Electrical Specifications, $T_A = +25^\circ \text{C}$ , $V_{cc1} = V_{cc2} = 5\text{V}$ , $Z_o = 75 \text{ Ohm}$ [1]

Parameter		Min.	Typ.	Max.	Units
Gain	0.05 - 0.5 GHz	13.5	14.7		dB
	0.5 - 0.87 GHz	12.7	14.2		dB
	0.87 - 1.0 GHz	12.1	13.4		dB
Gain Variation Over Temperature	0.05 - 0.87 GHz		0.008		dB/ °C
Input Return Loss	0.05 - 0.5 GHz		17		dB
	0.5 - 0.87 GHz		10		dB
Output Return Loss	0.05 - 0.5 GHz		10		dB
	0.5 - 0.87 GHz		20		dB
Reverse Isolation	0.05 - 0.87 GHz		23		dB
Output Power for 1 dB Compression (P1dB)	0.05 - 0.87 GHz	19.5	21		dBm
Output Third Order Intercept Point (IP3) (Pout= 0 dBm per tone, 1 MHz spacing)	0.05 - 0.87 GHz		38		dBm
Output Second Order Intercept Point (IP2)	0.05 - 0.5 GHz		78		dBm
Composite Second Order (CSO) [2]	0.05 - 0.87 GHz		-81		dBc
Composite Triple Beat (CTB) [2]	0.05 - 0.87 GHz		-75		dBc
Cross Modulation (XMOD) [2]	0.05 - 0.87 GHz		-67		dBc
Noise Figure	0.05 - 0.5 GHz		5.5		dB
	0.05 - 0.87 GHz		6.5		dB
Supply Current (Icc1 + Icc2)		145	160	175	mA

[1] Data taken with dual amplifiers combined in push-pull (default) configuration

[2] Input level +15 dBmV, 133 channels - with analog modulation



**GaAs HBT HIGH LINEARITY  
PUSH-PULL AMPLIFIER, 75 Ohm, DC - 1 GHz**

**Gain & Return Loss**

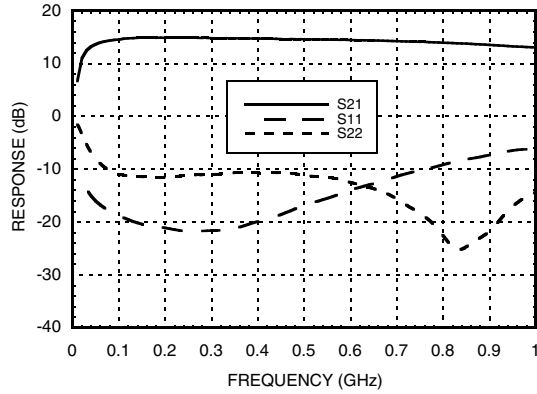

**Gain vs. Temperature**

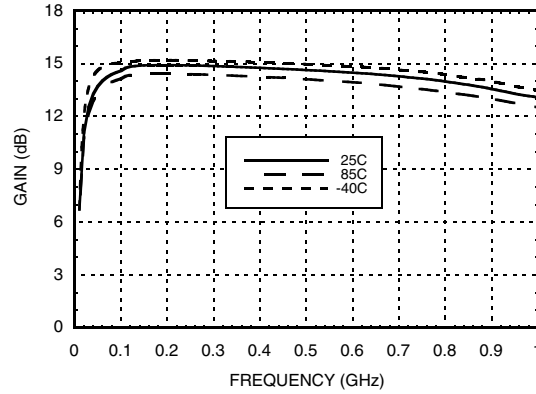

**Input Return Loss vs. Temperature**

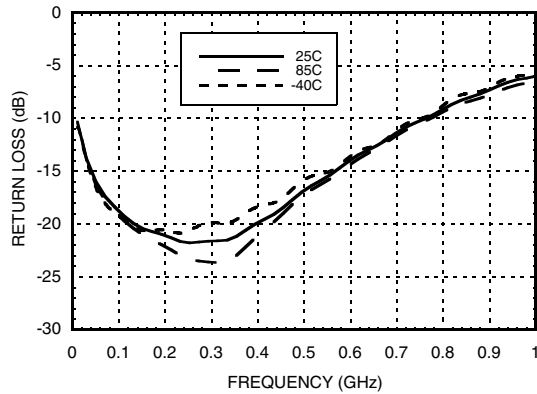

**Output Return Loss vs. Temperature**

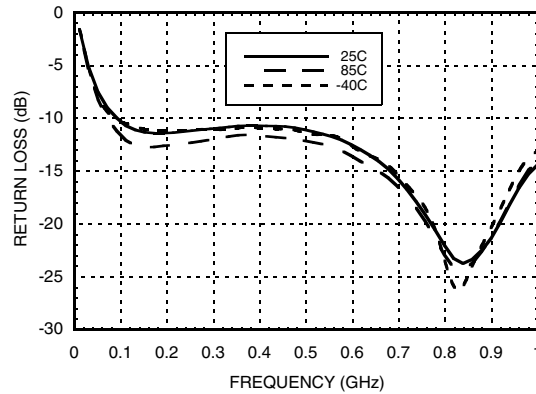

**Output IP3 vs. Temperature**

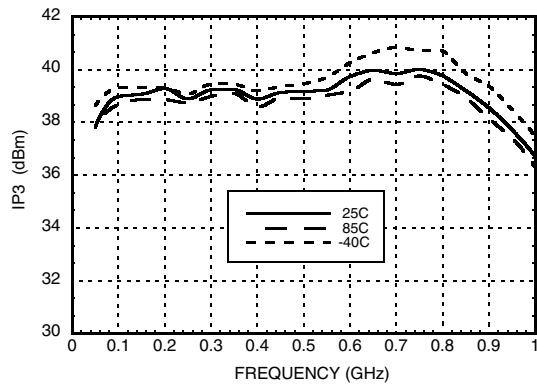

**Output IP2 vs. Temperature**

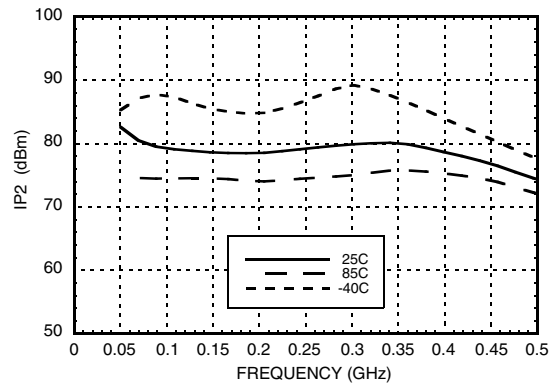



**GaAs HBT HIGH LINEARITY  
PUSH-PULL AMPLIFIER, 75 Ohm, DC - 1 GHz**

8

AMPLIFIERS - DRIVER & GAIN BLOCK - SMT

**Noise Figure vs. Temperature**

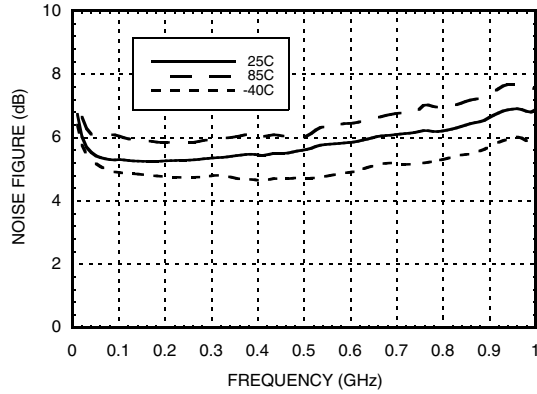

**P1dB vs. Temperature**

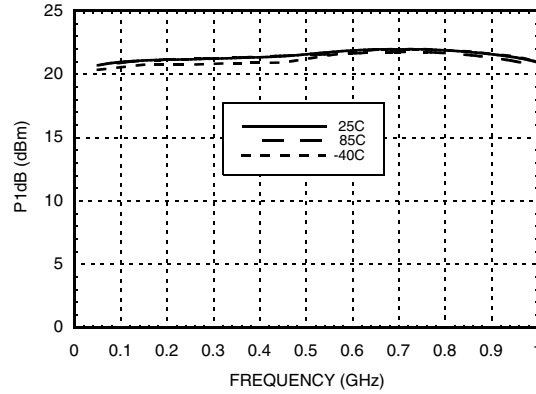

**Reverse Isolation vs. Temperature**

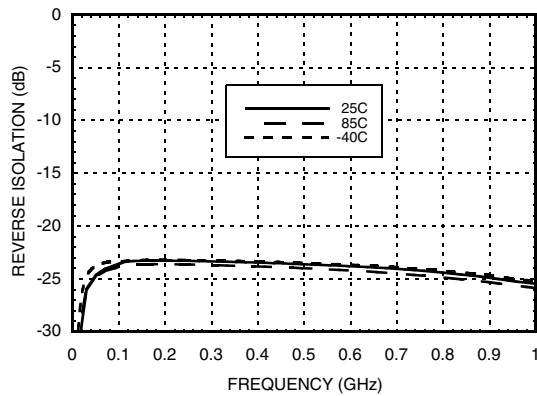

**Output IP2 vs. Output Power**

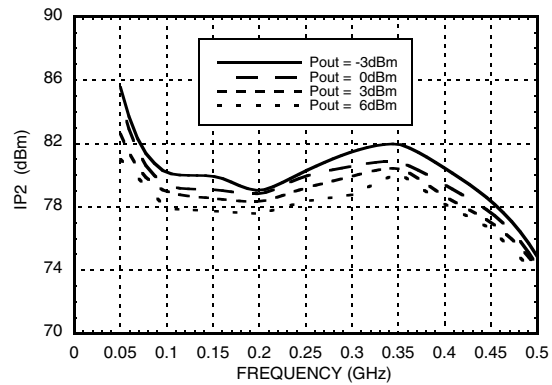

**CSO / CTB / XMOD  
@ +15 dBmV input, 133 channels (Analog)**

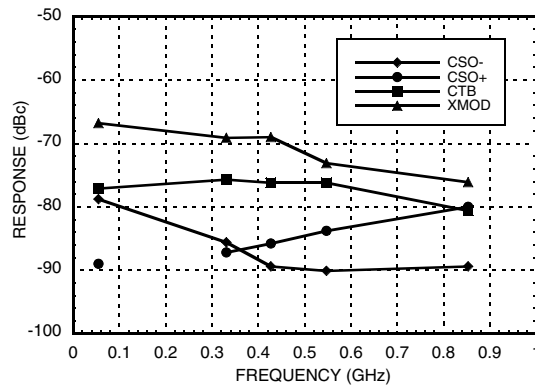



**GaAs HBT HIGH LINEARITY  
PUSH-PULL AMPLIFIER, 75 Ohm, DC - 1 GHz**

**Option 1 - Improved Input Return Loss & Gain Flatness (with Lower IP2) Application**

**Gain & Return Loss**

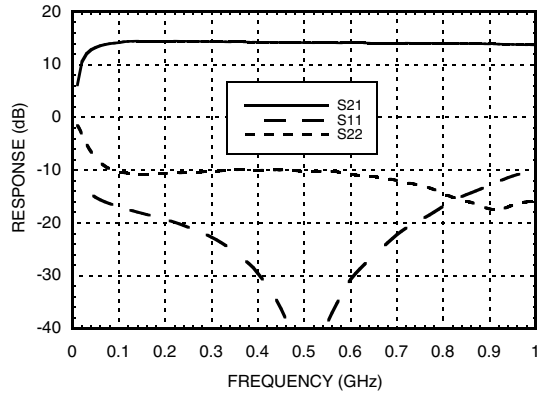

**Output IP2 vs. Frequency**

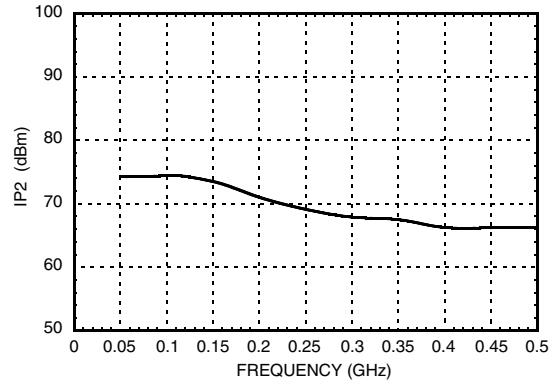

**Output IP3 vs. Frequency**

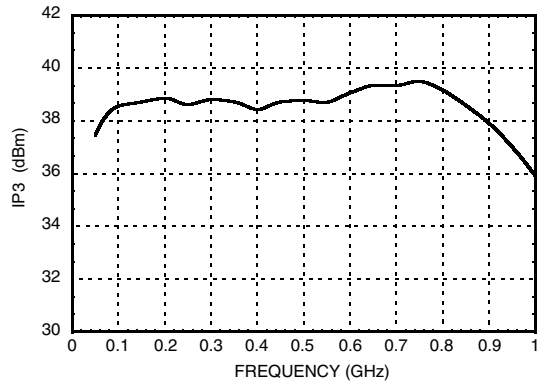

**Noise Figure vs. Frequency**

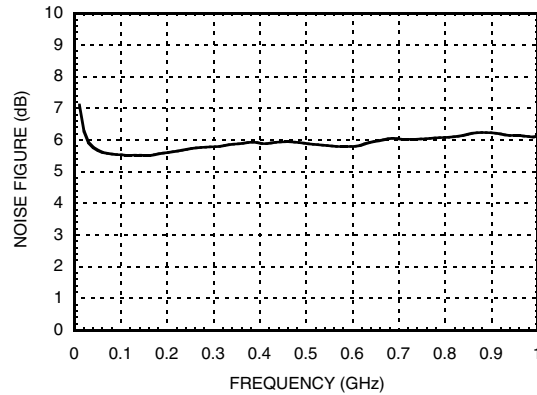

**P1dB vs. Frequency**

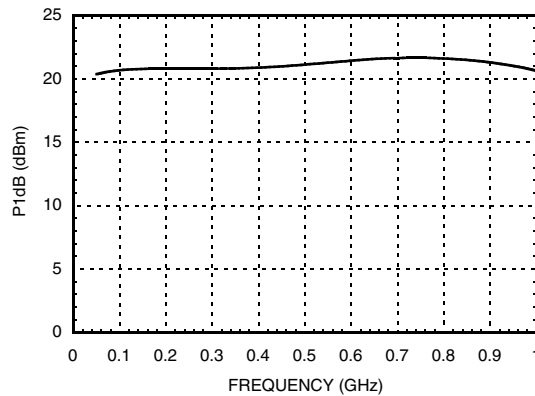



**GaAs HBT HIGH LINEARITY  
PUSH-PULL AMPLIFIER, 75 Ohm, DC - 1 GHz**

**Option 2 - 10 to 100 MHz Application**

**Gain & Return Loss**

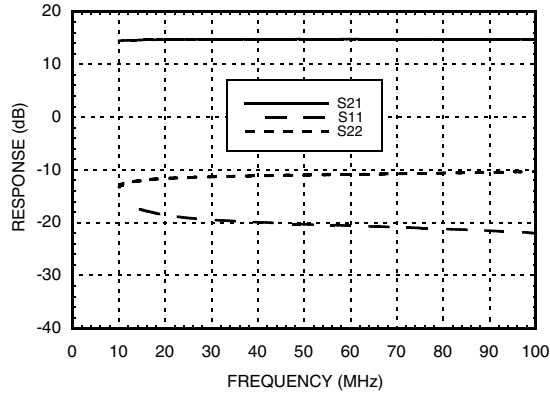

**Output IP3 vs. Frequency**

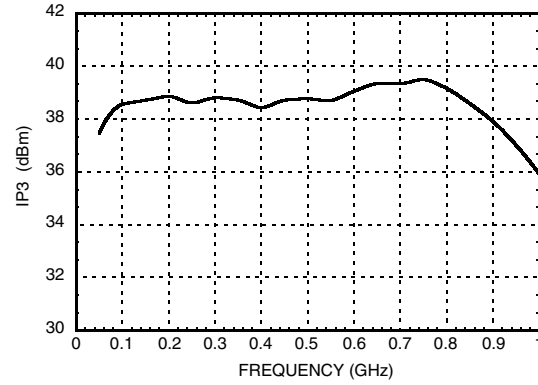

**Noise Figure vs. Frequency**

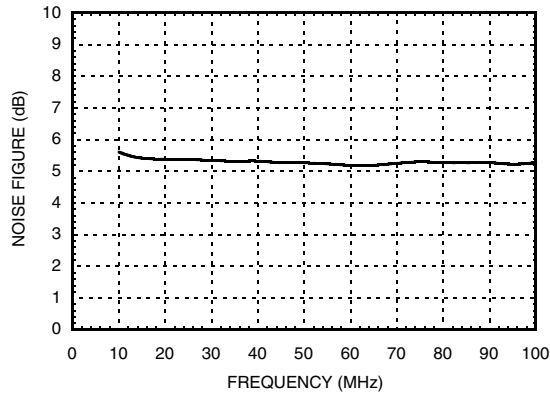

**P1dB vs. Frequency**

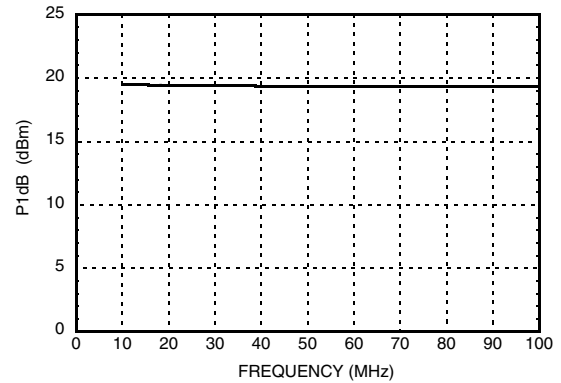



## GaAs HBT HIGH LINEARITY PUSH-PULL AMPLIFIER, 75 Ohm, DC - 1 GHz

### Absolute Maximum Ratings

Collector Bias Voltage (Vcc)	+5.5 Vdc
RF Input Power (RFIN)	+10 dBm
Junction Temperature	150 °C
Continuous P <sub>diss</sub> (T = 85 °C) (derate 18.69 mW/°C above 85 °C)	1.21 W
Thermal Resistance (junction to ground paddle)	53.5 °C/W
Storage Temperature	-65 to +150 °C
Operating Temperature	-40 to +85 °C
ESD Sensitivity (HBM)	Class 1C



ELECTROSTATIC SENSITIVE DEVICE  
OBSERVE HANDLING PRECAUTIONS

### Outline Drawing

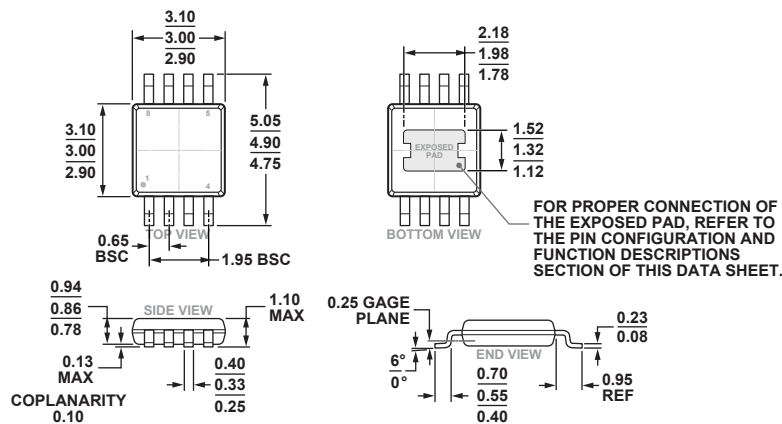

COMPLIANT TO JEDEC STANDARDS MO-187-AA-T

8-Lead Mini Small Outline Package with Exposed Pad [MINI\_SO\_EP]  
(RH-8-3)  
Dimensions shown in millimeters

### Package Information



Part Number	Package Body Material	Lead Finish	MSL Rating	Package Marking <sup>[3]</sup>
HMC754S8GE	RoHS-compliant Low Stress Injection Molded Plastic	100% matte Sn	MSL1 <sup>[2]</sup>	HMC754 XXXX
HMC754S8GETR	RoHS-compliant Low Stress Injection Molded Plastic	100% matte Sn	MSL1 <sup>[2]</sup>	HMC754 XXXX
124063- HMC754S8GE	Eval Board			
124825- HMC754S8GE	Eval Board			
126311- HMC754S8GE	Eval Board			

[1] Max peak reflow temperature of 235 °C  
 [2] Max peak reflow temperature of 260 °C  
 [3] 4-Digit lot number XXXX

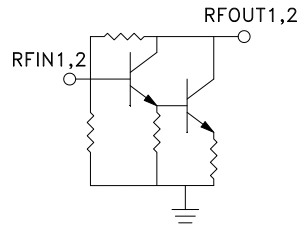

**GaAs HBT HIGH LINEARITY  
PUSH-PULL AMPLIFIER, 75 Ohm, DC - 1 GHz**

**Pin Descriptions**

Pin Number	Function	Description	Interface Schematic
1, 4	RFIN1, RFIN2	These pins are DC coupled. An off chip DC block capacitor is required.	
5, 8	RFOUT1/VCC1, RFOUT2/VCC2	RF Output and DC bias for the output stage.	
2	GND	These pins and package bottom must be connected to RF/ DC ground.	
3, 6, 7	N/C	No connection. These pins may be connected to RF ground. Performance will not be affected.	



**GaAs HBT HIGH LINEARITY  
PUSH-PULL AMPLIFIER, 75 Ohm, DC - 1 GHz**

**Application Circuit for Push-Pull Operation**

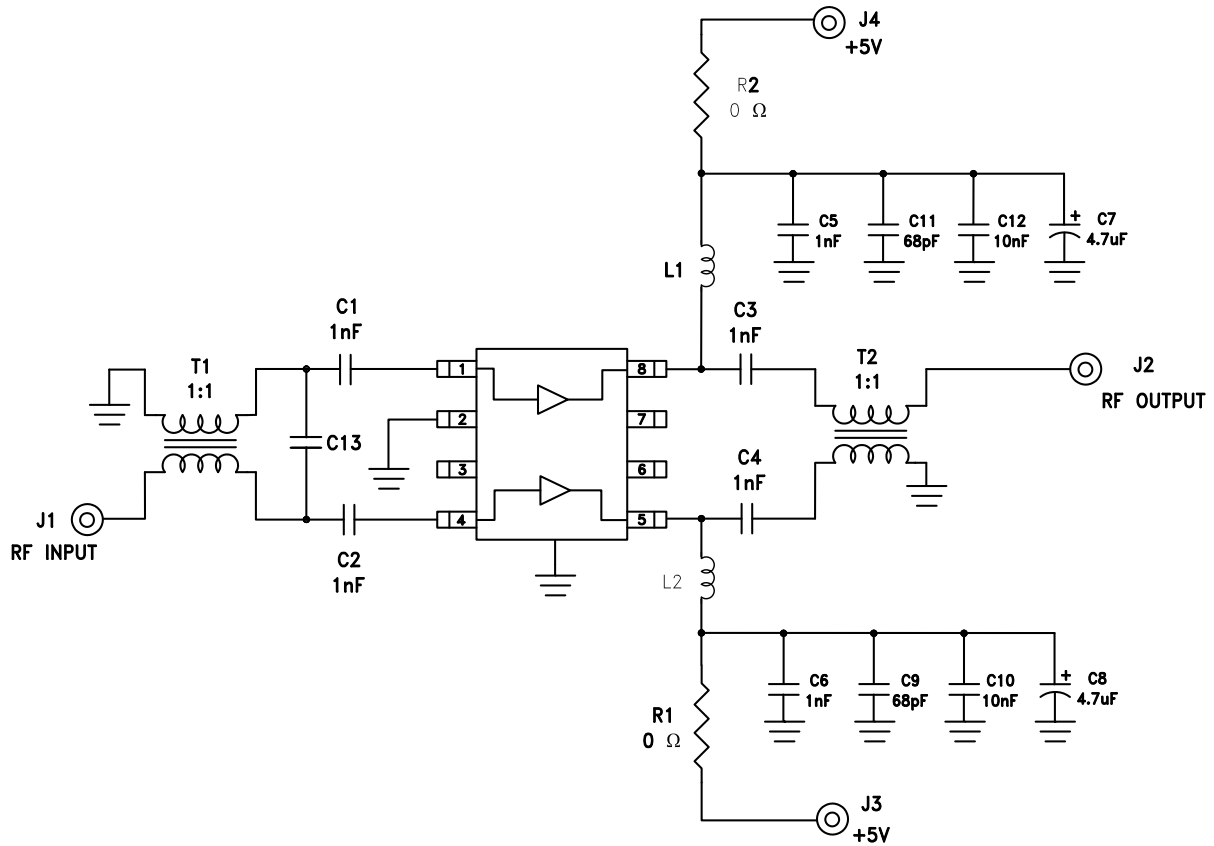

**Components for Selected Options**

Tune Options	Standard	Option 1	Option 2
Evaluation PCB Number	124063	126311	124825
T1 [1]	ETC 1-1-13	MABACT0039	ETC1-1T-5TR
T2 [1]	ETC 1-1-13	ETC 1-1-13	ETC1-1T-5TR
L1, L2	180 nH	180 nH	10 uH
C13	Open	1.1 pF	Open

[1] 1:1 Transformer





**GaAs HBT HIGH LINEARITY  
PUSH-PULL AMPLIFIER, 75 Ohm, DC - 1 GHz**

**Evaluation PCB - Standard and Option 2 Application**

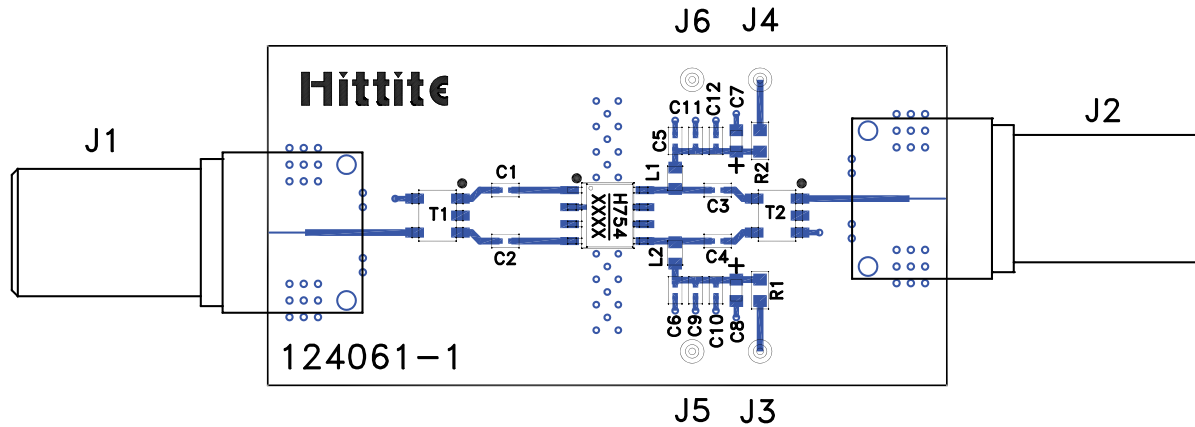

**List of Materials for Evaluation PCB [1]**

Item	Description
J1, J2	F-Connector
J3 - J6	DC PIN
C1 - C6	1 nF Capacitor, 0402 Pkg.
C7, C8	4.7 $\mu$ F Capacitor, Tantalum, 0603 Pkg.
C9, C11	68 pF Capacitor, 0402 Pkg.
C10, C12	10 nF Capacitor, 0402 Pkg.
L1, L2 [2]	Inductor, 0603 Pkg.
R1, R2	0 Ohm Resistor, 0603 Pkg.
T1, T2 [2]	1:1 Transformer
U1	HMC754S8GE Amplifier
PCB [3]	124061 Evaluation PCB

[1] When requesting an evaluation board, please reference the appropriate evaluation PCB number listed in the table "Components for Selected Options."

[2] Please refer to "Components for Selected Options" table for values

[3] Circuit Board Material: Rogers 4350 or Arlon 25FR

The circuit board used in the final application should use RF circuit design techniques. Signal lines should have 75 ohm impedance while the package ground leads and package bottom should be connected directly to the ground plane similar to that shown. A sufficient number of via holes should be used to connect the top and bottom ground planes. The evaluation board should be mounted to an appropriate heat sink. The evaluation circuit board shown is available from Analog Devices upon request.



### Evaluation PCB - Option 1 Application

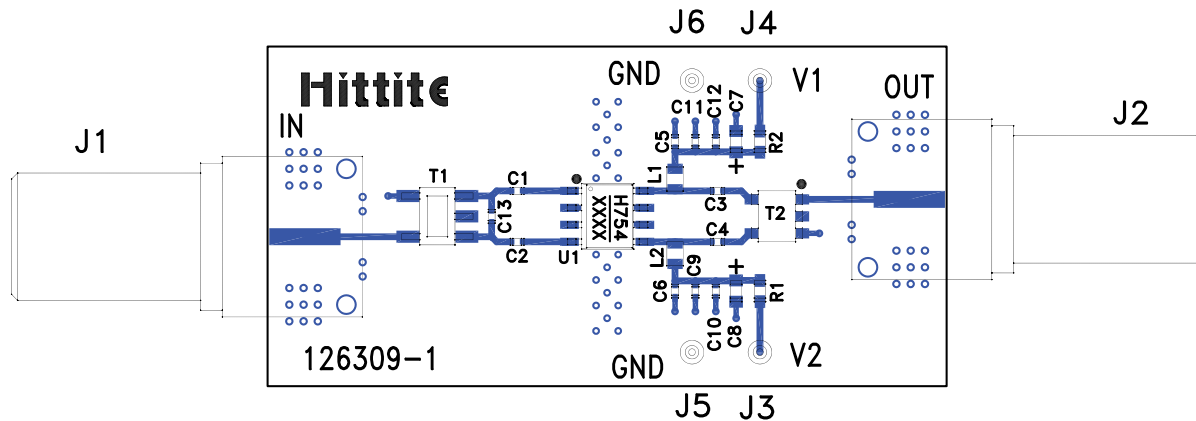

### List of Materials for Evaluation PCB [1]

Item	Description
J1, J2	F-Connector
J3 - J6	DC PIN
C1 - C6	1 nF Capacitor, 0402 Pkg.
C7, C8	4.7 $\mu$ F Capacitor, Tantalum, 0603 Pkg.
C9, C11	68 pF Capacitor, 0402 Pkg.
C10, C12	10 nF Capacitor, 0402 Pkg.
C13	1.1 pF Capacitor, 0402 Pkg.
L1, L2	180 nH Inductor, 0603 Pkg.
R1, R2	0 Ohm Resistor, 0603 Pkg.
T1, T2 [2]	1:1 Transformer
U1	HMC754S8GE Amplifier
PCB [3]	126309 Evaluation PCB

[1] When requesting an evaluation board, please reference the appropriate evaluation PCB number listed in the table "Components for Selected Options."

[2] Please refer to "Components for Selected Options" table for values

[3] Circuit Board Material: Rogers 4350 or Arlon 25FR

The circuit board used in the final application should use RF circuit design techniques. Signal lines should have 75 ohm impedance while the package ground leads and package bottom should be connected directly to the ground plane similar to that shown. A sufficient number of via holes should be used to connect the top and bottom ground planes. The evaluation board should be mounted to an appropriate heat sink. The evaluation circuit board shown is available from Analog Devices upon request.