

# Aluminum electrolytic capacitors

## Large-size capacitors

**Series/Type:** B43508

**Date:** December 2016

© EPCOS AG 2016. Reproduction, publication and dissemination of this publication, enclosures hereto and the information contained therein without EPCOS' prior express consent is prohibited.

EPCOS AG is a TDK Group Company.

## Long-life grade capacitors

### Application

- On-board chargers

### Features

- Extremely high CV product, compact
- High reliability
- High ripple current capability
- Capacitors pass the needle flame test according to IEC 60695-11-5 for all flame exposure times up to 120 s
- RoHS-compatible

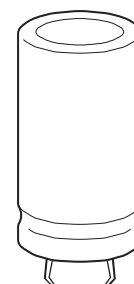

### Construction

- Charge/discharge-proof, polar
- Aluminum case, fully insulated with PET
- Up to 40 g vibration stability version available upon request
- Snap-in solder pins to hold component in place on PC-board
- Minus pole marking on case surface
- Minus pole not insulated from case
- Overload protection by safety vent on the base

### Terminals

- 3 terminals to ensure correct insertion: length 4.5 mm
- Version with wired terminals, weldable and solderable, available upon request

**Specifications and characteristics in brief**

Rated voltage $V_R$	450 V DC					
Surge voltage $V_S$	$1.10 \cdot V_R$					
Rated capacitance $C_R$	120 ... 680 $\mu\text{F}$					
Capacitance tolerance	$\pm 20\% \triangleq M$					
Dissipation factor $\tan \delta$ (20 °C, 120 Hz)	$\tan \delta \leq 0.20$					
Leakage current $I_{\text{leak}}$ (5 min, 20 °C)	$I_{\text{leak}} \leq 0.3 \mu\text{A} \cdot \left( \frac{C_R}{\mu\text{F}} \cdot \frac{V_R}{V} \right)^{0.7} + 4 \mu\text{A}$					
Self-inductance ESL	Approx. 20 nH					
Useful life <sup>1)</sup>		Requirements:				
105 °C; $V_R$ ; $I_{AC,R}$	> 3000 h	$ \Delta C/C  \leq 20\%$ of initial value				
85 °C; $V_R$ ; $I_{AC, \text{max}}$	> 6500 h	$\tan \delta \leq 2$ times initial specified limit				
40 °C; $V_R$ ; $1.9 \cdot I_{AC,R}$	> 200000 h	$I_{\text{leak}} \leq$ initial specified limit				
Voltage endurance test		Post test requirements:				
105 °C; $V_R$	2000 h	$ \Delta C/C  \leq 10\%$ of initial value				
		$\tan \delta \leq 1.3$ times initial specified limit				
		$I_{\text{leak}} \leq$ initial specified limit				
Vibration resistance test	To AEC-Q200 MIL-STD-202, methode 204: Frequency range 10 Hz ... 2 kHz, displacement amplitude max. 0.75 mm, acceleration max. 5 g, duration 3 × 4 h. Capacitor mounted by its body which is rigidly clamped to the work surface.					
Characteristics at low temperature	Max. impedance ratio at 100 Hz	<table border="1"> <tr> <td><math>Z_{-25^\circ\text{C}} / Z_{20^\circ\text{C}}</math></td> <td>7</td> </tr> <tr> <td><math>Z_{-40^\circ\text{C}} / Z_{20^\circ\text{C}}</math></td> <td>13</td> </tr> </table>	$Z_{-25^\circ\text{C}} / Z_{20^\circ\text{C}}$	7	$Z_{-40^\circ\text{C}} / Z_{20^\circ\text{C}}$	13
$Z_{-25^\circ\text{C}} / Z_{20^\circ\text{C}}$	7					
$Z_{-40^\circ\text{C}} / Z_{20^\circ\text{C}}$	13					
IEC climatic category	To IEC 60068-1: 25/105/56 (–25 °C/+105 °C/56 days damp heat test) The capacitors can be operated in the temperature range of –40 °C to +105 °C but the impedance at –40 °C must be taken into consideration.					
Detail specification	Similar to CECC 30301-809					
Sectional specification	IEC 60384-4, AEC-Q200					

1) Refer to chapter "General technical information, 5 Useful life" on how to interpret useful life.



**B43508**

**Compact – 105 °C**

**Dimensional drawing**

**Large-size capacitor, snap-in version with PET insulation**

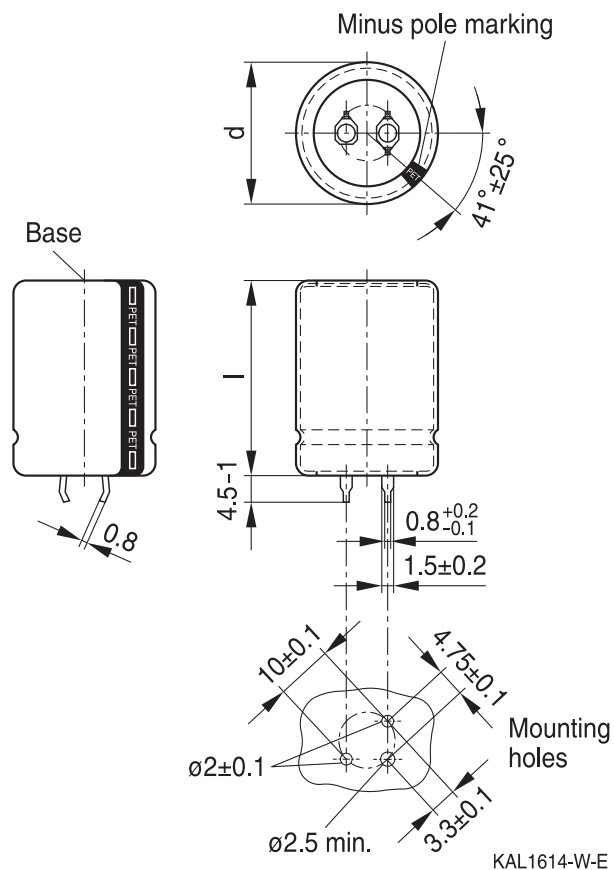

Dimensions (mm)		Approx. weight(g)	Packing units (pcs.)
d +1	l ±2		
25	30	17	130
25	35	19	130
25	40	22	130
25	50	29	130
25	55	32	130
30	30	23	80
30	35	29	80
30	40	36	80
30	45	41	80
30	55	53	80
35	35	36	60
35	40	41	60
35	45	56	60
35	55	81	60

Large-size capacitors, snap-in versions are available with 3 terminals (length (4.5 – 1) mm). PET insulation is marked with "PET" on the sleeve. Safety vent on the base.

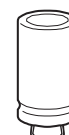

**Packing example of large-size capacitors, snap-in version**



For ecological reasons the packing is pure cardboard.

**Ordering codes for terminal styles and insulation features**

Identification in 3rd block of ordering code

Large-size capacitors

Terminal version

PET insulation

3 terminals 4.5 mm

M062

Ordering example:

B43508B5127M062 } Large-size capacitor, snap-in version with 3 terminals and PET insulation

**B43508**
**Compact – 105 °C**
**Technical data and ordering codes**

$C_R$ 100 Hz 20 °C $\mu\text{F}$	Case dimensions $d \times l$ mm	$\text{ESR}_{\text{typ}}$ 100 Hz 20 °C $\text{m}\Omega$	$Z_{\text{max}}$ 10 kHz 20 °C $\text{m}\Omega$	$I_{\text{AC,max}}$ 100 Hz 60 °C A	$I_{\text{AC,max}}$ 100 Hz 85 °C A	$I_{\text{AC,R}}^{1)}$ 100 Hz 105 °C A	Ordering code (composition see below)
<b><math>V_R = 450 \text{ V DC}</math></b>							
120	25 × 30	1020	1440	2.08	1.55	0.77	B43508B5127M062
150	25 × 30	820	1150	2.33	1.74	0.86	B43508B5157M062
180	25 × 35	680	960	2.64	1.97	0.97	B43508B5187M062
180	30 × 30	680	960	2.73	2.04	1.01	B43508C5187M062
220	25 × 40	560	790	3.01	2.25	1.11	B43508B5227M062
220	30 × 30	560	790	3.02	2.26	1.11	B43508C5227M062
270	25 × 50	460	640	3.51	2.63	1.30	B43508A5277M062
270	30 × 35	460	640	3.47	2.59	1.28	B43508B5277M062
330	25 × 55	370	530	3.97	2.97	1.47	B43508A5337M062
330	30 × 40	370	530	4.21	3.15	1.56	B43508B5337M062
330	35 × 35	370	530	4.06	3.04	1.50	B43508C5337M062
390	30 × 45	320	450	4.71	3.52	1.74	B43508A5397M062
390	35 × 35	320	450	4.42	3.30	1.63	B43508B5397M062
470	30 × 55	260	370	5.42	4.05	2.00	B43508A5477M062
470	35 × 40	260	370	5.00	3.74	1.85	B43508B5477M062
560	35 × 45	220	310	5.62	4.20	2.08	B43508A5567M062
680	35 × 55	180	260	6.50	4.86	2.40	B43508A5687M062

 1) 120-Hz conversion factor of ripple current:  $I_{\text{AC}}(120 \text{ Hz}) = 1.03 \cdot I_{\text{AC}}(100 \text{ Hz})$

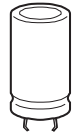

**Useful life<sup>1)</sup>**

The useful life graph is available upon request.

**Frequency factor of permissible ripple current  $I_{AC}$  versus frequency  $f$**

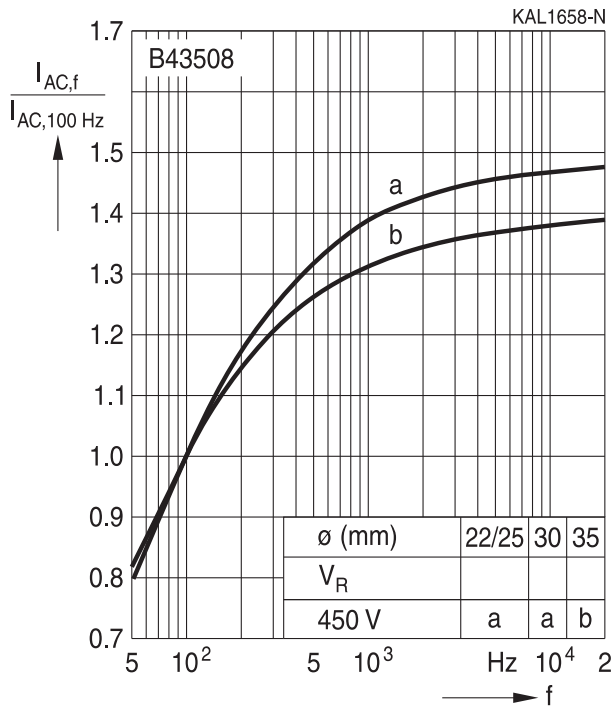

**Frequency characteristics of ESR  
Typical behavior**

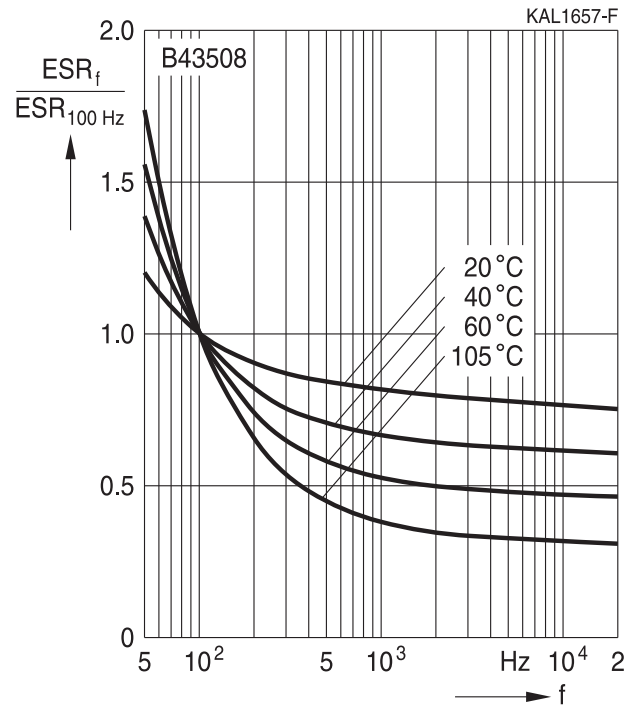

**Impedance  $Z$  versus frequency  $f$**

Typical behavior at 20 °C

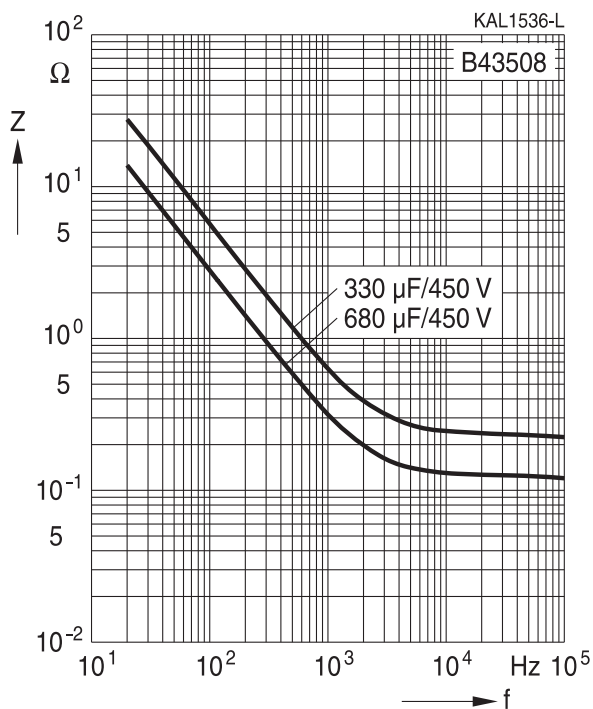

1) Refer to chapter "General technical information, 5 Useful life" on how to interpret useful life.



**B43508**

**Compact – 105 °C**

## Cautions and warnings

### Personal safety

The electrolytes used by EPCOS have been optimized both with a view to the intended application and with regard to health and environmental compatibility. They do not contain any solvents that are detrimental to health, e.g. dimethyl formamide (DMF) or dimethyl acetamide (DMAC).

Furthermore, some of the high-voltage electrolytes used by EPCOS are self-extinguishing.

As far as possible, EPCOS does not use any dangerous chemicals or compounds to produce operating electrolytes, although in exceptional cases, such materials must be used in order to achieve specific physical and electrical properties because no alternative materials are currently known. We do, however, restrict the amount of dangerous materials used in our products to an absolute minimum.

Materials and chemicals used in EPCOS aluminum electrolytic capacitors are continuously adapted in compliance with the EPCOS Corporate Environmental Policy and the latest EU regulations and guidelines such as RoHS, REACH/SVHC, GADSL, and ELV.

MDS (Material Data Sheets) are available on the EPCOS website for all types listed in the data book. MDS for customer specific capacitors are available upon request.

MSDS (Material Safety Data Sheets) are available for all of our electrolytes upon request.

Nevertheless, the following rules should be observed when handling aluminum electrolytic capacitors: No electrolyte should come into contact with eyes or skin. If electrolyte does come into contact with the skin, wash the affected areas immediately with running water. If the eyes are affected, rinse them for 10 minutes with plenty of water. If symptoms persist, seek medical treatment. Avoid inhaling electrolyte vapor or mists. Workplaces and other affected areas should be well ventilated. Clothing that has been contaminated by electrolyte must be changed and rinsed in water.





## Product safety

The table below summarizes the safety instructions that must be observed without fail. A detailed description can be found in the relevant sections of chapter "General technical information".

Topic	Safety information	Reference chapter "General technical information"
Polarity	Make sure that polar capacitors are connected with the right polarity.	1 "Basic construction of aluminum electrolytic capacitors"
Reverse voltage	Voltages of opposite polarity should be prevented by connecting a diode.	3.1.6 "Reverse voltage"
Mounting position of screw-terminal capacitors	Screw terminal capacitors must not be mounted with terminals facing down unless otherwise specified.	11.1. "Mounting positions of capacitors with screw terminals"
Robustness of terminals	The following maximum tightening torques must not be exceeded when connecting screw terminals: M5: 2.5 Nm M6: 4.0 Nm	11.3 "Mounting torques"
Mounting of single-ended capacitors	The internal structure of single-ended capacitors might be damaged if excessive force is applied to the lead wires. Avoid any compressive, tensile or flexural stress. Do not move the capacitor after soldering to PC board. Do not pick up the PC board by the soldered capacitor. Do not insert the capacitor on the PC board with a hole space different to the lead space specified.	11.4 "Mounting considerations for single-ended capacitors"
Soldering	Do not exceed the specified time or temperature limits during soldering.	11.5 "Soldering"
Soldering, cleaning agents	Do not allow halogenated hydrocarbons to come into contact with aluminum electrolytic capacitors.	11.6 "Cleaning agents"
Upper category temperature	Do not exceed the upper category temperature.	7.2 "Maximum permissible operating temperature"
Passive flammability	Avoid external energy, e.g. fire.	8.1 "Passive flammability"



**B43508**

**Compact – 105 °C**

Topic	Safety information	Reference chapter "General technical information"
Active flammability	Avoid overload of the capacitors.	8.2 "Active flammability"
Maintenance	Make periodic inspections of the capacitors. Before the inspection, make sure that the power supply is turned off and carefully discharge the capacitors. Do not apply excessive mechanical stress to the capacitor terminals when mounting.	10 "Maintenance"
Storage	Do not store capacitors at high temperatures or high humidity. Capacitors should be stored at +5 to +35 °C and a relative humidity of ≤ 75%.	7.3 "Shelf life and storage conditions"
		Reference chapter "Capacitors with screw terminals"
Breakdown strength of insulating sleeves	Do not damage the insulating sleeve, especially when ring clips are used for mounting.	"Screw terminals – accessories"

### Display of ordering codes for EPCOS products

The ordering code for one and the same product can be represented differently in data sheets, data books, other publications and the website of EPCOS, or in order-related documents such as shipping notes, order confirmations and product labels. The varying representations of the ordering codes are due to different processes employed and do not affect the specifications of the respective products.

Detailed information can be found on the Internet under [www.epcos.com/orderingcodes](http://www.epcos.com/orderingcodes).

**Symbols and terms**

Symbol	English	German
C	Capacitance	Kapazität
$C_R$	Rated capacitance	Nennkapazität
$C_S$	Series capacitance	Serienkapazität
$C_{S,T}$	Series capacitance at temperature T	Serienkapazität bei Temperatur T
$C_f$	Capacitance at frequency f	Kapazität bei Frequenz f
d	Case diameter, nominal dimension	Gehäusedurchmesser, Nennmaß
$d_{max}$	Maximum case diameter	Maximaler Gehäusedurchmesser
ESL	Self-inductance	Eigeninduktivität
ESR	Equivalent series resistance	Ersatzserienwiderstand
$ESR_f$	Equivalent series resistance at frequency f	Ersatzserienwiderstand bei Frequenz f
$ESR_T$	Equivalent series resistance at temperature T	Ersatzserienwiderstand bei Temperatur T
f	Frequency	Frequenz
I	Current	Strom
$I_{AC}$	Alternating current (ripple current)	Wechselstrom
$I_{AC,RMS}$	Root-mean-square value of alternating current	Wechselstrom, Effektivwert
$I_{AC,f}$	Ripple current at frequency f	Wechselstrom bei Frequenz f
$I_{AC,max}$	Maximum permissible ripple current	Maximal zulässiger Wechselstrom
$I_{AC,R}$	Rated ripple current	Nennwechselstrom
$I_{leak}$	Leakage current	Reststrom
$I_{leak,op}$	Operating leakage current	Betriebsreststrom
l	Case length, nominal dimension	Gehäuselänge, Nennmaß
$l_{max}$	Maximum case length (without terminals and mounting stud)	Maximale Gehäuselänge (ohne Anschlüsse und Gewindebolzen)
R	Resistance	Widerstand
$R_{ins}$	Insulation resistance	Isolationswiderstand
$R_{symm}$	Balancing resistance	Symmetrierwiderstand
T	Temperature	Temperatur
$\Delta T$	Temperature difference	Temperaturdifferenz
$T_A$	Ambient temperature	Umgebungstemperatur
$T_C$	Case temperature	Gehäusetemperatur
$T_B$	Capacitor base temperature	Temperatur des Gehäusebodens
t	Time	Zeit
$\Delta t$	Period	Zeitraum
$t_b$	Service life (operating hours)	Brauchbarkeitsdauer (Betriebszeit)



**B43508**

**Compact – 105 °C**

Symbol	English	German
V	Voltage	Spannung
$V_F$	Forming voltage	Formierspannung
$V_{op}$	Operating voltage	Betriebsspannung
$V_R$	Rated voltage, DC voltage	Nennspannung, Gleichspannung
$V_S$	Surge voltage	Spitzenspannung
$X_C$	Capacitive reactance	Kapazitiver Blindwiderstand
$X_L$	Inductive reactance	Induktiver Blindwiderstand
Z	Impedance	Scheinwiderstand
$Z_T$	Impedance at temperature T	Scheinwiderstand bei Temperatur T
$\tan \delta$	Dissipation factor	Verlustfaktor
$\lambda$	Failure rate	Ausfallrate
$\epsilon_0$	Absolute permittivity	Elektrische Feldkonstante
$\epsilon_r$	Relative permittivity	Dielektrizitätszahl
$\omega$	Angular velocity; $2 \cdot \pi \cdot f$	Kreisfrequenz; $2 \cdot \pi \cdot f$

**Note**

All dimensions are given in mm.

## Important notes

The following applies to all products named in this publication:

1. Some parts of this publication contain **statements about the suitability of our products for certain areas of application**. These statements are based on our knowledge of typical requirements that are often placed on our products in the areas of application concerned. We nevertheless expressly point out **that such statements cannot be regarded as binding statements about the suitability of our products for a particular customer application**. As a rule we are either unfamiliar with individual customer applications or less familiar with them than the customers themselves. For these reasons, it is always ultimately incumbent on the customer to check and decide whether a product with the properties described in the product specification is suitable for use in a particular customer application.
2. We also point out that **in individual cases, a malfunction of electronic components or failure before the end of their usual service life cannot be completely ruled out in the current state of the art, even if they are operated as specified**. In customer applications requiring a very high level of operational safety and especially in customer applications in which the malfunction or failure of an electronic component could endanger human life or health (e.g. in accident prevention or life-saving systems), it must therefore be ensured by means of suitable design of the customer application or other action taken by the customer (e.g. installation of protective circuitry or redundancy) that no injury or damage is sustained by third parties in the event of malfunction or failure of an electronic component.
3. **The warnings, cautions and product-specific notes must be observed.**
4. In order to satisfy certain technical requirements, **some of the products described in this publication may contain substances subject to restrictions in certain jurisdictions (e.g. because they are classed as hazardous)**. Useful information on this will be found in our Material Data Sheets on the Internet ([www.tdk-electronics.tdk.com/material](http://www.tdk-electronics.tdk.com/material)). Should you have any more detailed questions, please contact our sales offices.
5. We constantly strive to improve our products. Consequently, **the products described in this publication may change from time to time**. The same is true of the corresponding product specifications. Please check therefore to what extent product descriptions and specifications contained in this publication are still applicable before or when you place an order.

We also **reserve the right to discontinue production and delivery of products**. Consequently, we cannot guarantee that all products named in this publication will always be available. The aforementioned does not apply in the case of individual agreements deviating from the foregoing for customer-specific products.

6. Unless otherwise agreed in individual contracts, **all orders are subject to our General Terms and Conditions of Supply**.
7. **Our manufacturing sites serving the automotive business apply the IATF 16949 standard**. The IATF certifications confirm our compliance with requirements regarding the quality management system in the automotive industry. Referring to customer requirements and customer specific requirements ("CSR") TDK always has and will continue to have the policy of respecting individual agreements. Even if IATF 16949 may appear to support the acceptance of unilateral requirements, we hereby like to emphasize that **only requirements mutually agreed upon can and will be implemented in our Quality Management System**. For clarification purposes we like to point out that obligations from IATF 16949 shall only become legally binding if individually agreed upon.

## Important notes

8. The trade names EPCOS, CeraCharge, CeraDiode, CeraLink, CeraPad, CeraPlas, CSMP, CTVS, DeltaCap, DigiSiMic, ExoCore, FilterCap, FormFit, LeaXield, MiniBlue, MiniCell, MKD, MKK, MotorCap, PCC, PhaseCap, PhaseCube, PhaseMod, PhiCap, PowerHap, PQSine, PQvar, SIFERRIT, SIFI, SIKOREL, SilverCap, SIMDAD, SiMic, SIMID, SineFormer, SIOV, ThermoFuse, WindCap are **trademarks registered or pending** in Europe and in other countries. Further information will be found on the Internet at [www.tdk-electronics.tdk.com/trademarks](http://www.tdk-electronics.tdk.com/trademarks).

Release 2018-10

# Mouser Electronics

Authorized Distributor

Click to View Pricing, Inventory, Delivery & Lifecycle Information:

## EPCOS / TDK:

[B43508A5687M060](#) [B43508A5687M007](#) [B43508A5687M002](#) [B43508A5687M000](#) [B43508B9687M087](#)  
[B43508B9687M082](#) [B43508B9687M080](#) [B43508B9687M067](#) [B43508B9687M062](#) [B43508B9687M060](#)  
[B43508B9687M000](#) [B43508A9687M087](#) [B43508A9687M082](#) [B43508A9687M080](#) [B43508A9687M067](#)  
[B43508A9687M062](#) [B43508A9687M060](#) [B43508A9687M007](#) [B43508A9687M002](#) [B43508H2687M087](#)  
[B43508H2687M082](#) [B43508H2687M080](#) [B43508H2687M067](#) [B43508H2687M062](#) [B43508H2687M060](#)  
[B43508H2687M000](#) [B43508G2687M087](#) [B43508G2687M082](#) [B43508G2687M080](#) [B43508G2687M067](#)  
[B43508G2687M062](#) [B43508G2687M060](#) [B43508G2687M000](#) [B43508F2687M087](#) [B43508F2687M082](#)  
[B43508F2687M080](#) [B43508F2687M067](#) [B43508F2687M062](#) [B43508F2687M060](#) [B43508F2687M007](#)  
[B43508F2687M002](#) [B43508F2687M000](#) [B43508E2687M087](#) [B43508E2687M082](#) [B43508E2687M080](#)  
[B43508E2687M067](#) [B43508E2687M062](#) [B43508E2687M060](#) [B43508E2687M000](#) [B43508A5687M087](#)  
[B43508A5687M082](#) [B43508A5687M080](#) [B43508A5687M067](#) [B43508A5826M087](#) [B43508A5826M082](#)  
[B43508A5826M080](#) [B43508A5826M067](#) [B43508A5826M062](#) [B43508A5826M060](#) [B43508A5826M000](#)  
[B43508A9827M087](#) [B43508A9827M082](#) [B43508A9827M080](#) [B43508A9827M067](#) [B43508A9827M062](#)  
[B43508A9827M060](#) [B43508A9827M007](#) [B43508A9827M000](#) [B43508G2827M087](#) [B43508G2827M082](#)  
[B43508G2827M080](#) [B43508G2827M067](#) [B43508G2827M062](#) [B43508G2827M060](#) [B43508G2827M000](#)  
[B43508F2827M087](#) [B43508F2827M082](#) [B43508F2827M080](#) [B43508F2827M067](#) [B43508F2827M062](#)  
[B43508F2827M060](#) [B43508F2827M000](#) [B43508E2827M087](#) [B43508E2827M082](#) [B43508E2827M080](#)  
[B43508E2827M067](#) [B43508E2827M062](#) [B43508E2827M060](#) [B43508E2827M000](#) [B43508F2158M087](#)  
[B43508F2158M082](#) [B43508F2158M080](#) [B43508F2158M067](#) [B43508F2158M062](#) [B43508F2158M060](#)  
[B43508F2158M000](#) [B43508E2158M087](#) [B43508E2158M082](#) [B43508E2158M080](#) [B43508E2158M067](#)