

Features

- 802.11a + b/g and MIMO Applications
- Test and Measurement and Low/Medium Power Telecommunication Applications up to 8.0 GHz
- Broadband Performance: DC - 8.0 GHz
- Low Insertion Loss: 0.5 dB from 2.0 - 6.0 GHz
- High Isolation: 30 dB from 2.0 - 6.0 GHz
- Fast Settling for Low Gate Lag Requirements
- Lead-Free 2 mm 8-Lead PDFN Package
- 100% Matte Tin Plating over Copper
- Halogen-Free "Green" Mold Compound
- RoHS Compliant* and 260°C Reflow Compatible

Description

M/A-COM's MASW-007107 is a broadband GaAs pHEMT MMIC SPDT switch in a lead-free 2 mm 8-lead PDFN package. Typical applications are for WLAN IEEE 802.11a + b/g, and MIMO. Other applications include test equipment requiring ultra fast switching speeds. Designed for low insertion loss, this SPDT switch maintains low loss up to 8.0 GHz.

The MASW-007107 is fabricated using a 0.5 micron gate length GaAs pHEMT process. The process features full passivation for performance and reliability.

Ordering Information ^{1,2}

| Part Number | Package |
|---------------------------------|----------------------------|
| MASW-007107-TR3000 | 3000 piece reel |
| MASW-007107-000SMB | Sample Test Board |
| MASW-007107-000DIE ³ | Separated die on grip ring |
| MASW-007107-0GPDIE | 100 piece gel pack |

1. Reference Application Note M513 for reel size information.
2. All sample boards include 5 loose parts.
3. Die quantity varies.

* Restrictions on Hazardous Substances, European Union Directive 2002/95/EC.

Functional Schematic

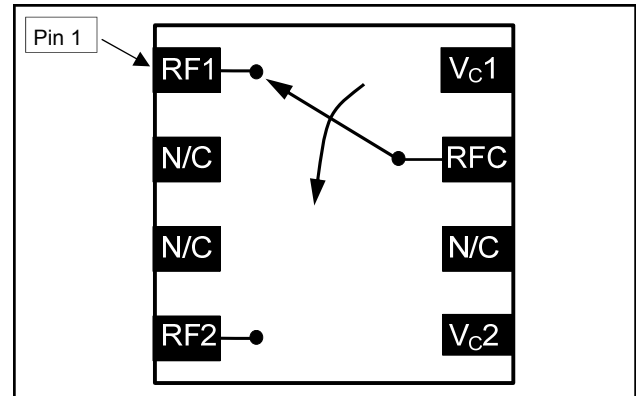

Pin Configuration ⁴

| Pin No. | Pin Name | Description |
|---------|---------------------|-------------------|
| 1 | RF1 | RF Output 1 |
| 2 | N/C | No Connection |
| 3 | N/C | No Connection |
| 4 | RF2 | RF Output 2 |
| 5 | Vc2 | Voltage Control 2 |
| 6 | N/C | No Connection |
| 7 | RFC | RF Common |
| 8 | Vc1 | Voltage Control 1 |
| 9 | Paddle ⁵ | RF and DC Ground |

4. M/A-COM recommends connecting unused package pins to ground.
5. The exposed pad centered on the package bottom must be connected to RF and DC ground.

Absolute Maximum Ratings ^{6,7}

| Parameter | Absolute Maximum |
|---------------------------|------------------|
| Input Power @ 3 V Control | +32 dBm |
| Input Power @ 5 V Control | +34 dBm |
| Operating Voltage | +8.5 volts |
| Operating Temperature | -40°C to +85°C |
| Storage Temperature | -65°C to +150°C |

6. Exceeding any one or combination of these limits may cause permanent damage to this device.
7. M/A-COM does not recommend sustained operation near these survivability limits.

ADVANCED: Data Sheets contain information regarding a product M/A-COM Technology Solutions is considering for development. Performance is based on target specifications, simulated results, and/or prototype measurements. Commitment to develop is not guaranteed.
PRELIMINARY: Data Sheets contain information regarding a product M/A-COM Technology Solutions has under development. Performance is based on engineering tests. Specifications are typical. Mechanical outline has been fixed. Engineering samples and/or test data may be available. Commitment to produce in volume is not guaranteed.

• **North America** Tel: 800.366.2266 / Fax: 978.366.2266
 • **Europe** Tel: 44.1908.574.200 / Fax: 44.1908.574.300
 • **Asia/Pacific** Tel: 81.44.844.8296 / Fax: 81.44.844.8298
 Visit www.macomtech.com for additional data sheets and product information.

M/A-COM Technology Solutions Inc. and its affiliates reserve the right to make changes to the product(s) or information contained herein without notice.

GaAs Broadband SPDT Switch DC - 8.0 GHz

Rev. V5

Electrical Specifications: $T_A = 25^\circ\text{C}$, $Z_0 = 50 \Omega$, $V_C = 0 \text{ V} / 3 \text{ V}$, 8 pF Capacitor ^{8,9}

| Parameter | Test Conditions | Units | Min. | Typ. | Max. |
|------------------------------|---|-------|------|------|------|
| Insertion Loss ¹⁰ | 2.0 - 6.0 GHz | dB | — | 0.50 | 0.8 |
| | 6.0 - 8.0 GHz | dB | — | 0.75 | — |
| Isolation | 2.4 GHz | dB | 24 | 29 | — |
| | 5.3 GHz | dB | 28 | 33 | — |
| | 5.8 GHz | dB | 25 | 30 | — |
| | 6.0 - 8.0 GHz | dB | — | 20 | — |
| Return Loss | DC - 8.0 GHz | dB | — | 16 | — |
| Input IP2 | Two Tone, +5 dBm / Tone, 5 MHz Spacing | | | | |
| | 2.4 GHz | dBm | — | 92 | — |
| | 5.3 GHz | dBm | — | 83 | — |
| | 5.8 GHz | dBm | — | 85 | — |
| Input IP3 | Two Tone, +5 dBm / Tone, 10 MHz Spacing | | | | |
| | 2.4 GHz (3V) | dBm | — | 54 | — |
| | 5.8 GHz (3V) | dBm | — | 49 | — |
| | 2.4 GHz (5V) | dBm | — | 55 | — |
| | 5.8 GHz (5V) | dBm | — | 51 | — |
| | Two Tone, +15 dBm / Tone, 10 MHz Spacing | | | | |
| | 2.4 GHz (3V) | dBm | — | 57 | — |
| | 5.8 GHz (3V) | dBm | — | 54 | — |
| 2.4 GHz (5V) | dBm | — | 59 | — | |
| 5.8 GHz (5V) | dBm | — | 58 | — | |
| Input P0.1dB | 2.4 GHz | dBm | — | 26 | — |
| | 5.3 GHz | dBm | — | 26 | — |
| | 5.8 GHz | dBm | — | 25 | — |
| Input P1dB | 2.4 GHz | dBm | — | 30.5 | — |
| | 5.3 GHz | dBm | — | 29.5 | — |
| | 5.8 GHz | dBm | — | 27 | — |
| Linear Pout | 2.4 GHz, OFDM, QAM-64, 54 Mbps, EVM = 2.5% | | | | |
| | 3 V | dBm | — | 21 | — |
| | 5 V | dBm | — | 27.5 | — |
| 8 V | dBm | — | 30 | — | |
| 2nd Harmonic | 2.4 GHz, PIN = +20 dBm | dBc | — | -80 | — |
| | 5.3 GHz, PIN = +20 dBm | dBc | — | -71 | — |
| | 5.8 GHz, PIN = +20 dBm | dBc | — | -71 | — |
| 3rd Harmonic | 2.4 GHz, PIN = +20 dBm | dBc | — | -83 | — |
| | 5.3 GHz, PIN = +20 dBm | dBc | — | -71 | — |
| | 5.8 GHz, PIN = +20 dBm | dBc | — | -72 | — |
| T-rise, T-fall | 10% to 90% RF and 90% to 10% RF | ns | — | 13 | — |
| Ton, Toff | 50% control to 90% RF and 50% control to 10% RF | ns | — | 35 | — |
| Transients | | mV | — | 14 | — |
| Control Current | VC = 3 V | μA | — | 1 | 5 |
| RON | t > 90 ms after OFF to ON Switching (settled) | Ω | — | 2.50 | — |
| Gate Lag | ΔRon between 15 μs and 90 ms after OFF to ON Switching | Ω | — | 0.15 | — |

8. For positive voltage control, external DC blocking capacitors are required on all RF ports.

9. Electrical minimum and maximum specifications are guaranteed in final package assembly only.

10. Insertion loss can be optimized by varying the DC blocking capacitor value.

2

ADVANCED: Data Sheets contain information regarding a product M/A-COM Technology Solutions is considering for development. Performance is based on target specifications, simulated results, and/or prototype measurements. Commitment to develop is not guaranteed.

PRELIMINARY: Data Sheets contain information regarding a product M/A-COM Technology Solutions has under development. Performance is based on engineering tests. Specifications are typical. Mechanical outline has been fixed. Engineering samples and/or test data may be available. Commitment to produce in volume is not guaranteed.

• **North America** Tel: 800.366.2266 / Fax: 978.366.2266

• **Europe** Tel: 44.1908.574.200 / Fax: 44.1908.574.300

• **Asia/Pacific** Tel: 81.44.844.8296 / Fax: 81.44.844.8298

Visit www.macomtech.com for additional data sheets and product information.

M/A-COM Technology Solutions Inc. and its affiliates reserve the right to make changes to the product(s) or information contained herein without notice.

Die Outline Drawing ^{11,12,13,14}

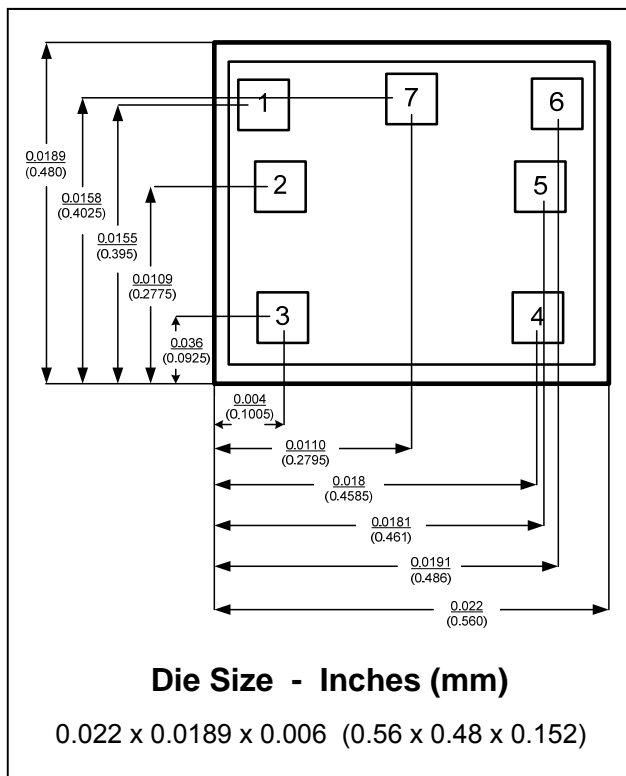

11. Typical dimensions in inches (millimeters)
12. Die thickness is 0.006" (0.152 mm)
13. Typical bond pad is 0.003" square (0.076 mm square)
14. Bond pad metallization is gold.

Qualification

Qualified to M/A-COM specification REL-201, Process Flow -2.

Handling Procedures

Please observe the following precautions to avoid damage:

Static Sensitivity

Gallium Arsenide Integrated Circuits are sensitive to electrostatic discharge (ESD) and can be damaged by static electricity. Proper ESD control techniques should be used when handling these devices.

Die Bond Pad Configuration

| Pad No. | Name | Description |
|---------|-----------------|-------------------|
| 1 | V _{c1} | Voltage Control 1 |
| 2 | RF1 | RF Output 1 |
| 3 | GND | Ground |
| 4 | GND | Ground |
| 5 | RF2 | RF Output 2 |
| 6 | V _{c2} | Voltage Control 2 |
| 7 | RFC | RF Common |

Application Schematic

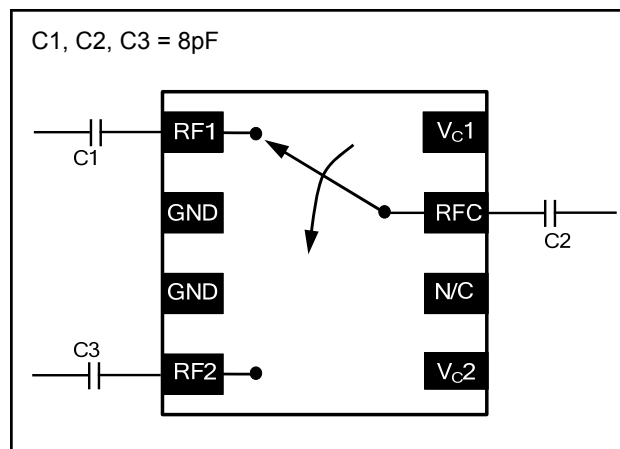

Truth Table ¹⁵

| Control V _{c1} | Control V _{c2} | RFC—RF1 | RFC—RF2 |
|-------------------------|-------------------------|---------|---------|
| 1 | 0 | On | Off |
| 0 | 1 | Off | On |

15. 1 = +2.9 V to +5 V, 0 = 0 V ± 0.2 V.

Typical Performance Curves

Return Loss vs. Frequency

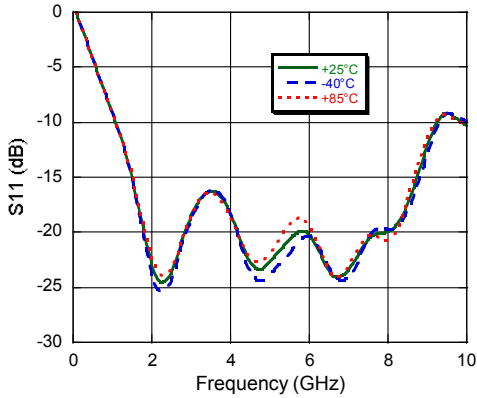

Isolation vs. Frequency

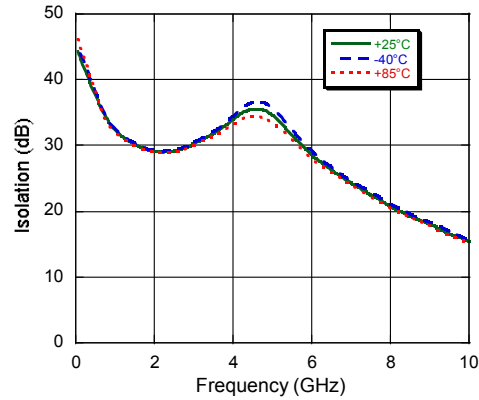

Insertion Loss vs. Frequency

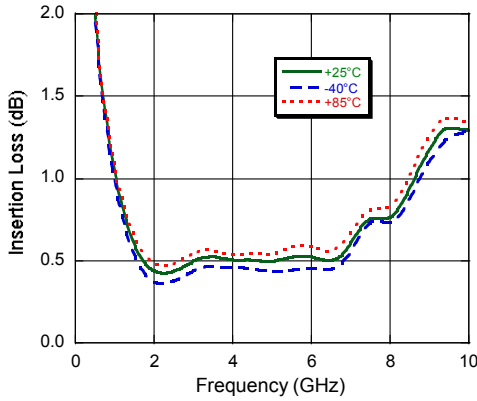

EVM vs. Pout @ 2.4 GHz

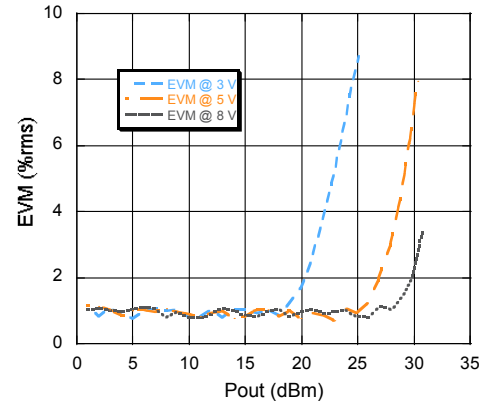

Lead Free 2 mm 8-lead PDFN †

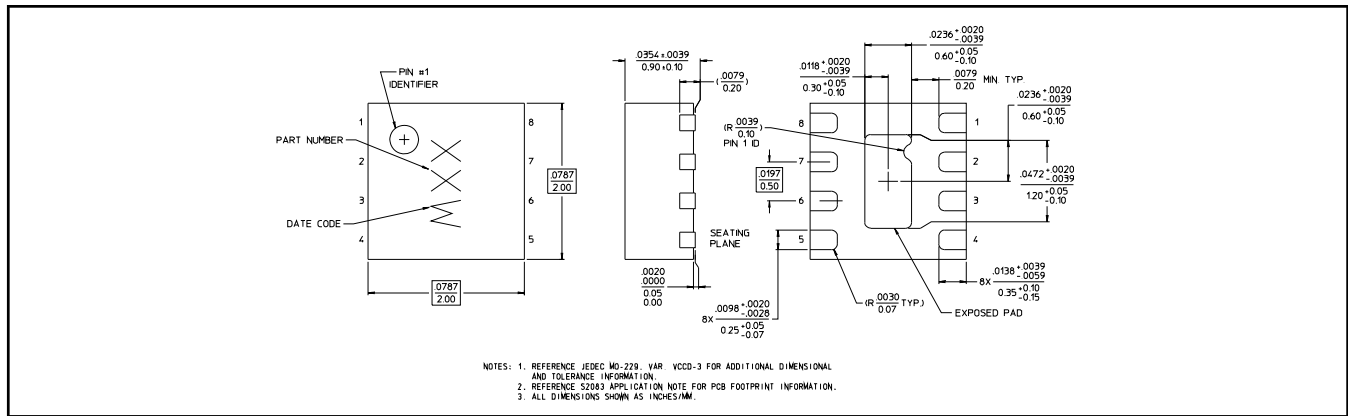

† Reference Application Note M538 for lead-free solder reflow recommendations. Meets JEDEC moisture sensitivity level 1 requirements.

ADVANCED: Data Sheets contain information regarding a product M/A-COM Technology Solutions is considering for development. Performance is based on target specifications, simulated results, and/or prototype measurements. Commitment to develop is not guaranteed.
PRELIMINARY: Data Sheets contain information regarding a product M/A-COM Technology Solutions has under development. Performance is based on engineering tests. Specifications are typical. Mechanical outline has been fixed. Engineering samples and/or test data may be available. Commitment to produce in volume is not guaranteed.

• **North America** Tel: 800.366.2266 / Fax: 978.366.2266
 • **Europe** Tel: 44.1908.574.200 / Fax: 44.1908.574.300
 • **Asia/Pacific** Tel: 81.44.844.8296 / Fax: 81.44.844.8298
 Visit www.macomtech.com for additional data sheets and product information.

M/A-COM Technology Solutions Inc. and its affiliates reserve the right to make changes to the product(s) or information contained herein without notice.