

Genesis™

GENH Series
Programmable DC Power Supplies
750W in a 1U half-rack size
Built in RS-232 & RS-485 Interface
Advanced Parallel Standard

Optional Interfaces:
IEEE488.2 SCPI (GPIB)
Isolated Analog Programming
LXI Compliant LAN



TDK-Lambda

Genesys™ GENH750W-1U

The Genesys™ family of programmable power supplies sets a new standard for flexible, reliable, AC/DC power systems in OEM, Industrial and Laboratory applications.

Features include:

- High Power Density available: 750W in 1U half-rack size.
- Wide Range Input (85 - 265Vac Continuous)
- Active Power Factor Correction (0.99 typical)
- Output Voltage up to 600V, Current up to 100A
- Built-in RS-232/RS-485 Interface
- Front Panel Lockout
- Last-Setting Memory
- High Resolution 16 bit ADCs & DACs
- Reliable Encoders for Voltage and Current Adjustment
- Constant Voltage/Constant Current auto-crossover
- Advanced Parallel reports total current up to four identical units
- Global Commands for Serial RS-232/RS-485 Interface
- Independent Remote ON/OFF and Remote Enable/Disable
- External Analog Programming and Monitoring
- Reliable Modular and SMT Design
- 19" Rack Mounted ATE benchtop and OEM applications
- Side-by-side mounting of two units in a 19" rack
- Optional Interfaces
 - Isolated Analog Programming and Monitoring Interface (0-5V/0-10V & 4-20mA)
 - IEEE 488.2 SCPI (GPIB) Multi-Drop
 - LXI** Compliant LAN
- LabView® and LabWindows® drivers
- Five Year Warranty

Worldwide Safety Agency Approvals; CE Mark for LVD and EMC Regulation



Front Panel Description



1. AC ON/OFF Switch
2. Air Intake allows zero stacking for maximum system flexibility and power density.
3. Reliable encoder controls Output Voltage and sets Address.
4. Volt Display shows Output Voltage and directly displays OVP, UVL and Address settings.
5. Reliable encoder controls Output Current, sets baudrate and Advanced Parallel mode.
6. Current Display shows Output Current and displays baudrate.
7. Function/Status LEDs:
 - Alarm
 - Fine Control
 - Preview Settings
 - Foldback Mode
 - Remote Mode
 - Output On
8. Pushbuttons allow flexible user configuration
 - Coarse and Fine adjustment of Output Voltage/Current and Advanced Parallel Master or Slave
 - Preview settings and set Voltage/Current with Output OFF, Front Panel Lockout
 - Set OVP and UVL Limits
 - Set Current Foldback
 - Local/Remote Mode and select Address and Baudrate
 - Output ON/OFF and Auto-Start/Safe-Start Mode

Applications

Genesys™ power supplies have been designed to meet the demands of a wide variety of applications.

Test and Measurement

Last-Setting memory simplifies test design and requires no battery backup.

Built-in RS-232/RS-485 gives maximum system flexibility along with 0-5V and 0-10V, selectable analog programming.

Wide range of available inputs allows testing of many different devices.

Semiconductor Burn-in

Safe-Start may be ENABLED to re-start at Output OFF to protect load.

Wide range input (85-265Vac) with Active Power Factor correction rides through input transients easily.

Component Test

High power density, zero stacking and single wire parallel operation give maximum system flexibility.

Laser Diode

OVP is directly set on Voltage Display, assuring accurate protection settings.

Current Limit Fold Back assures load is protected from current surges.

Heater Supplies

Smooth, reliable encoders enhance front panel control.

Remote analog programming is user selectable 0-5V or 0-10V.

RF Amplifiers and Magnets

Robust design assures stable operation under a wide variety of loads.

High linearity in voltage and current mode.

Rear Panel Description

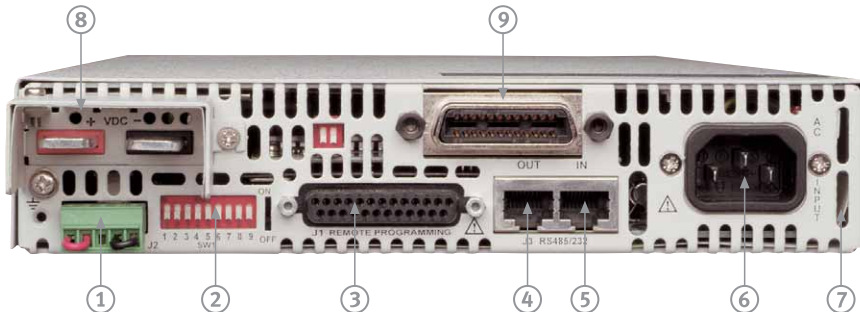

1. Remote/Local Output Voltage Sense Connections.
2. DIP Switches select 0-5V or 0-10V Programming and other functions.
3. DB25 (Female) connector allows (Non-isolated) Analog Program and Monitor and other functions.
4. RS-485 OUT to other Genesys™ Power Supplies.
5. RS-232/RS-485 IN Remote Serial Programming.
6. Wide-Range Input 85-265VAC continuous, 47/63Hz with Active Power Factor Correction (0.99 typical)
AC Input Connector: IEC320.
7. Exit air assures reliable operation when zero stacked.
8. Output Connections: Rugged busbars for 6V up to 60V Output; Connector for Outputs >60V.
9. Optional Interface Position for IEEE 488.2 SCPI (shown) or Isolated Analog Interface or LAN Interface.

Genesys™ GENH750W Specifications

1.0 MODEL	GENH	6-100	8-90	12.5-60	20-38	30-25	40-19	60-12.5	80-9.5	100-7.5	150-5	300-2.5	600-1.3
1. Rated output voltage (*1)	V	6	8	12.5	20	30	40	60	80	100	150	300	600
2. Rated Output Current (*2)	A	100	90	60	38	25	19	12.5	9.5	7.5	5	2.5	1.3
3. Rated Output Power	W	600	720	750	760	750	760	750	760	750	750	750	780
4. Efficiency at 100/200Vac (*3)	%	76/78	78/81	81/84	82/85	82/85	83/87	83/87	83/87	83/87	83/87	83/87	83/87

1.1 CONSTANT VOLTAGE MODE

1. Max. line regulation (0.01% of Vo+2mV) (*4)	mV	2.6	2.8	3.3	4	5	6	8	10	12	17	32	62
2. Max load regulation (0.01% of Vo+2mV) (*5)	mV	2.6	2.8	3.3	4	5	6	8	10	12	17	32	62
3. Ripple and noise p-p 20MHz (*9)	mV	60	60	60	60	60	60	60	80	80	100	150	300
4. Ripple r.m.s 5Hz~1MHz (*9)	mV	8	8	8	8	8	8	8	8	8	10	25	60
5. Remote sense compensation/line	V	1	1	1	1	1.5	2	3	4	5	5	5	5
6. Temp. coefficient	PPM/°C	100PPM/°C of rated output voltage, following 30 minutes warm up											
7. Up-prog. response time, 0-Vo Rated	mS	80mS, N.L./F.L., resistive load							150mS, N.L./F.L., resistive load			250	
8. Down-prog response time full-load	mS	10	50			80			150			250	
9. Down-prog response time no-load	mS	500	600	700	800	900	1000	1100	1200	1500	2000	2500	4000
10. Transient response time (*8)		Less than 1mSec for models up to and including 100V. 2msec for models above 100V											

1.2 CONSTANT CURRENT MODE

1. Max. line regulation (0.01% of Io+2mA) (*4)	mA	12	11	8.0	5.8	4.5	3.9	3.25	2.95	2.75	2.5	2.25	2.13
2. Max. load regulation (0.02% of Io+5mA) (*6)	mA	25	23	17	12.6	10	8.8	7.5	6.9	6.5	6.0	5.5	5.26
3. Ripple r.m.s 5Hz~1MHz (*7)	mA	200	180	120	76	63	48	38	29	23	18	13	8
4. Temp. coefficient	PPM/°C	100PPM/°C from rated output current, following 30 minutes warm up											

1.3 PROTECTIVE FUNCTIONS

1. OCP	0~105% Constant Current												
2. OCP Foldback	Output shut down when power supply change from CV to CC. User selectable.												
3. OVP type	Inverter shut-down, manual reset by AC input recycle or by OUT button or by communication port												
4. OVP trip point	0.5~7.5V	0.5~10V	1~15V	1~24V	2~36V	2~44V	5~66V	5~88V	5~110V	5~165V	5~330V	5~660V	
5. Over Temp. Protection	User selectable, latched or non latched												

1.4 ANALOG PROGRAMMING AND MONITORING

1. Vout Voltage Programming	0~100%, 0~5V or 0~10V, user select. Accuracy and linearity: +/-0.5% of rated Vout.												
2. Iout Voltage Programming	0~100%, 0~5V or 0~10V, user select. Accuracy and linearity: +/-1% of rated Iout.												
3. Vout Resistor Programming	0~100%, 0~5/10Kohm full scale, user select. Accuracy and linearity: +/-1% of rated Vout.												
4. Iout Resistor Programming	0~100%, 0~5/10Kohm full scale, user select. Accuracy and linearity: +/-1.5% of rated Iout.												
5. On/Off control (rear panel)	By electrical. Voltage: 0~0.6V/2~15V, or dry contact, user selectable logic												
6. Output Current monitor	0~5V or 0~10V, accuracy: 1%, user selectable												
7. Output Voltage monitor	0~5V or 0~10V, accuracy: 1%, user selectable												
8. Power Supply OK signal	TTL High=OK, 0V-Fail 500ohm impedance												
9. CV/CC indicator	CV: TTL high (4~5V) source: 10mA, CC: TTL low (0~0.6V) sink current: 10mA												
10. Enable/Disable	Dry contact. Open: off, Short: on. Max. voltage at Enable/Disable in: 6V												
11. Local/Remote analog control	By electrical signal or Open/Short: 0~0.6V or short: Remote analog, 4~5V or open: Local.												
12. Local/Remote analog control indicator	Open collector, Local: Open, Remote: On. Maximum voltage: 30V, maximum sink current: 5mA.												

1.5 FRONT PANEL

1. Control functions	Vout/ Iout manual adjust by separate encoders (coarse and fine adjustment selectable) OVP/UVL manual adjust by Volt. Adjust encoder AC on/off, Output on/off, Re-start modes (auto, safe), Foldback control (CV to CC), Go to local control Front Panel Lock Address selection by Voltage (or current) adjust encoder. Number of addresses: 31 RS232/485 and IEEE488.2 selection by IEEE enable switch and DIP switch Baudrate selection: 1200, 2400, 4800, 9600 and 19,200												
2. Display	Voltage 4 digits, accuracy: 0.5% +/-1 count Current 4 digits, accuracy: 0.5% +/-1 count												
3. Indications	Voltage, Current, Alarm, Fine, Preview, Foldback, Local, Output On, Front Panel Lock												

1.6 Interface RS-232&RS-485 or Optional GPIB / LAN Interface

Model	V	6	8	12.5	20	30	40	60	80	100	150	300	600
1. Remote Voltage Programming (16 bit)													
Resolution (0.012% of Vo Rated)	mV	0.72	0.96	1.50	2.40	3.60	4.80	7.2	9.6	12	18	36	72
Accuracy (0.05%Vo Rated+0.05% of Vo Actual Output)	mV	6.0	8.0	12.5	20	30	40	60	80	100	150	300	600
2. Remote Current Programming (16 bit)													
Resolution (0.012% of Io Rated)	mA	12	10.8	7.2	4.56	3.0	2.28	1.50	1.14	0.90	0.60	0.30	0.16
Accuracy (0.1% of Io Rated+0.1% of Io Actual Output)	mA	200	180	120	76	50	38	25	19	15	10	5.0	2.6
3. Readback Voltage													
Resolution (0.012% of Vo Rated)	mV	0.72	0.96	1.50	2.40	3.60	4.80	7.2	9.6	12	18	36	72
Accuracy (0.1%Vo Rated+0.1% of Vo Actual Output)	mV	12	16	25	40	60	80	120	160	200	300	600	1200
4. Readback Current													
Resolution (0.012% of Io Rated)	mA	12	10.8	7.2	4.56	3.0	2.28	1.50	1.14	0.90	0.60	0.30	0.16
Accuracy (0.3% of Io Rated+0.1% of Io Actual Output)	mA	400	360	240	152	100	76	50	38	30	20	10	5.2
5. OVP/UVL Programming													
Resolution (0.1% of Vo Rated)	mV	6	8	12	20	30	40	60	80	100	150	300	600
Accuracy (1% of Vo Rated)	mV	60	80	125	200	300	400	600	800	1000	1500	3000	6000

*1: Minimum voltage is guaranteed to maximum 0.2% of Vo Rated.

*2: Minimum current is guaranteed to maximum 0.4% of Io Rated

*3: At maximum output power.

*4: 85~132Vac or 170~265Vac, constant load.

*5: From No-load to Full-load, constant input voltage.

*6: For load voltage change, equal to the unit voltage rating, constant input voltage.

*7: For 6V models the ripple is measured at 2~6V output voltage and full output current. For other models, the ripple is measured at 10~100% output voltage and full output current.

*8: Time for the output voltage to recover within 0.5% of its rated for a load change 10~90% of rated output current, Output set-point: 10~100%.

*9: For 6V~300V models: measured with JEITA RC-9131A 1:1 probe. For 600V model: measured with 10:1 probe

Accuracy -Values have been calculated at Vo Rated & Io Rated

2.1 INPUT CHARACTERISTICS

1. Input voltage/freq. (*1)	85~265Vac continuous, 47~63Hz, single phase
2. Power Factor	0.99 @ 100/200Vac, rated output power.
3. EN61000-3-2,3 compliance	Complies with EN61000-3-2 class A and EN61000-3-3 at 20~100% output power.
4. Input current 100/200Vac	10.5A / 5A,
5. Inrush current 100/200Vac	Less than 25A,
6. Hold-up time	More than 20mS , 100Vac , at 100% load.

2.2 POWER SUPPLY CONFIGURATION

1. Parallel Operation	Up to 4 units in master/slave mode with single wire current balance connection
2. Series Operation	Up to 2 units. with external diodes. 600V Max to Chassis ground

2.3 ENVIRONMENTAL CONDITIONS

1. Operating temp	0~50°C, 100% load.
2. Storage temp	-20~70°C
3. Operating humidity	30~90% RH (non-condensing).
4. Storage humidity	10~95% RH (non-condensing).
5. Vibration	MIL-810E, method 514.4 , test cond. I-3.3.1. The EUT is fixed to the vibrating surface.
6. Shock	Less than 20G , half sine , 11mSec. Unit is unpacked.
7. Altitude	Operating: 10000ft (3000m), Derat output current by 2%/100m above 2000m, Non operating: 40000ft (12000m).

2.4 EMC

1. Applicable Standards:	
2. ESD	IEC1000-4-2. Air-disch.-8KV, contact disch.-4KV
3. Fast transients	IEC1000-4-4. 2KV
4. Surge immunity	IEC1000-4-5. 1KV line to line, 2KV line to ground
5. Conducted immunity	IEC1000-4-6. 3V
6. Radiated immunity	IEC1000-4-3. 3V/m
7. Conducted emission	EN55022B, FCC part 15J-B, VCCI-B
8. Radiated emission	EN55022A, FCC part 15-A, VCCI-A
9. Voltage dips	EN61000-4-11
10. Conducted emission	EN55022B, FCC part 15-B, VCCI-B.
11. Radiated emission	EN55022A, FCC part 15-A, VCCI-A.

2.5 SAFETY

1. Applicable standards:	CE Mark, UL60950, EN60950 listed. Vout<60V: Output is SELV , IEEE/Isolated analog are SELV. 60<Vout<400V: Output is hazardous, IEEE/Isolated analog are SELV. 400<Vout<600V: Output is hazardous, IEEE/Isolated analog are not SELV.
2. Withstand voltage	Vout<60V models :Input-Outputs (SELV): 3.0KVrms 1min, Input-Ground: 2.0KVrms 1min. 60<Vout<600V models: Input-Haz. Output: 2.5KVrms 1min, Input-SELV: 3KVrms 1min. Hazardous Output.-SELV: 1.9KVrms 1min, Hazardous Output-Ground:1.9KVrms 1min. Input-Ground: 2KVrms 1min.
3. Insulation resistance	More than 100Mohm at 25°C , 70% RH, 500Vdc

2.6 MECHANICAL CONSTRUCTION

1. Cooling	Forced air flow: from front to rear. No ventilation holes at the top or bottom of the chassis; Variable fan speed.
2. Dimensions (WxHxD)	W: 214.0mm, H: 43.6mm, (57.0mm Benchtop version), D: 437.5mm (excluding connectors, encoders, handles, etc.)
3. Weight	4.5Kg (9.9 Lbs)
4. AC Input connector	IEC320 AC Inlet.
5. Output connectors	6V to 60V models: Bus-bars (hole Ø 6.5mm). 80V to 600V models: Meating plug, Phoenix P/N: GIC 2.5/4-ST-7.62.

2.7 RELIABILITY SPECS

1. Warranty	5 years.
-------------	----------

*1: For cases where conformance to various safety standards (UL, IEC etc.) is required, to be described as 100-240Vac (50/60Hz).
All specifications subject to change without notice.

**Also available Genesys™
1U full Rack 750W/1500W & 2U 3300W**



Genesys™ Power Benchtop Parallel and Series Configurations

Benchtop Power Supply

Parallel operation - Master/Slave:

Active current sharing allows up to four identical units to be connected in an auto-parallel configuration for four times the output power.

In Advanced Parallel Master/Slave Mode, total current is programmed and reported by the Master, Up to four supplies act as one.

Series operation

Up to two units may be connected in series to increase the output voltage or to provide bipolar output. (Max 600V to Chassis Ground).



Remote Programming via RS-232 & RS-485 Interface

Standard Serial Interface allows chain control of up to 31 power supplies on the same bus with built-in RS-232 & RS-485 Interface.

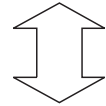
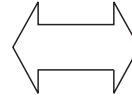

Programming Options (Factory installed)

Digital Programming via IEEE Interface

P/N: IEEE

- IEEE 488.2 SCPI Compliant
- Program Voltage
- Measure Voltage
- Over Voltage setting and shutdown
- Error and Status Messages
- **New!** Multi-Drop
 - Allows IEEE Master to control up to 31 slaves over RS-485 daisy-chain
 - Only the Master needs be equipped with IEEE Interface
- Program Current
- Measure Current
- Current Foldback shutdown

Isolated Analog Programming

Four Channels to Program and Monitor Voltage and Current.

Isolation allows operation with floating references in harsh electrical environments.

Choose between programming with Voltage or Current.

Connection via removable terminal block: Phoenix MC1,5/8-ST-3.81.

- Voltage Programming, user-selectable 0-5V or 0-10V signal. P/N: IS510
 - Power supply Voltage and Current Programming Accuracy $\pm 1\%$
 - Power supply Voltage and Current Monitoring Accuracy $\pm 1.5\%$
- Current Programming with 4-20mA signal. P/N: IS420
 - Power supply Voltage and Current Programming Accuracy $\pm 1\%$
 - Power supply Voltage and Current Monitoring Accuracy $\pm 1.5\%$

LAN Interface

LXI Compliant to Class C

P/N: LAN

- Meets all LXI-C Requirements
- Address Viewable on Front Panel
- Fixed and Dynamic Addressing
- Compatible with most standard Networks
- VISA & SCPI Compatible
- LAN Fault Indicators
- Auto-detects LAN Cross-over Cable
- Fast Startup

Accessories

Rack Mounting applications P/N:GENH/RM

The Rack Mounted kit allows the units to be zero stacking for maximum system flexibility and power density without increasing the 1U height of the units

To install one GENH750W unit or two units side-by-side in a standard 19" rack in 1U(1.75") height, use option kit P/N:GENH/RM

Single unit installation

Single GENH750W power supply in a standard 19" rack in 1U(1.75") height,



Dual unit installation

Two GENH750W power supplies side-by-side in a standard 19" rack in 1U(1.75") height,



Benchtop applications P/N:GENH/MO

The benchtop stacking kit allows the units to be Zero stacked for maximum system flexibility and power density without increasing the 1U height of the units.

To install a GENH750W two units or three units one on top of the other use option kit P/N:GENH/MO



Communication cable

RS-232/RS-485 Cable is used to connect the power supply to the PC Controller.

Mode	RS-485	RS-232	RS-232
PC Connector	DB-9F	DB-9F	DB-25F
Communication Cable	Shield Ground L=2m	Shield Ground L=2m	FShield Ground L=2m
Power Supply Connector	EIA/TIA-568A (RJ-45)	EIA/TIA-568A (RJ-45)	EIA/TIA-568A (RJ-45)
P/N	GEN/485-9	GEN/232-9	GEN/232-25

Serial link cable*

Daisy-chain up to 31 Genesys™ power supplies.

Mode	Power Supply Connector	Communication Cable	P/N
RS-485	EIA/TIA-568A (RJ-45)	Shield Ground L=50cm	GEN/RJ45

* Included with power supply

Outline Drawings Genesys™ GENH 750W

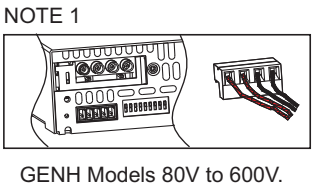
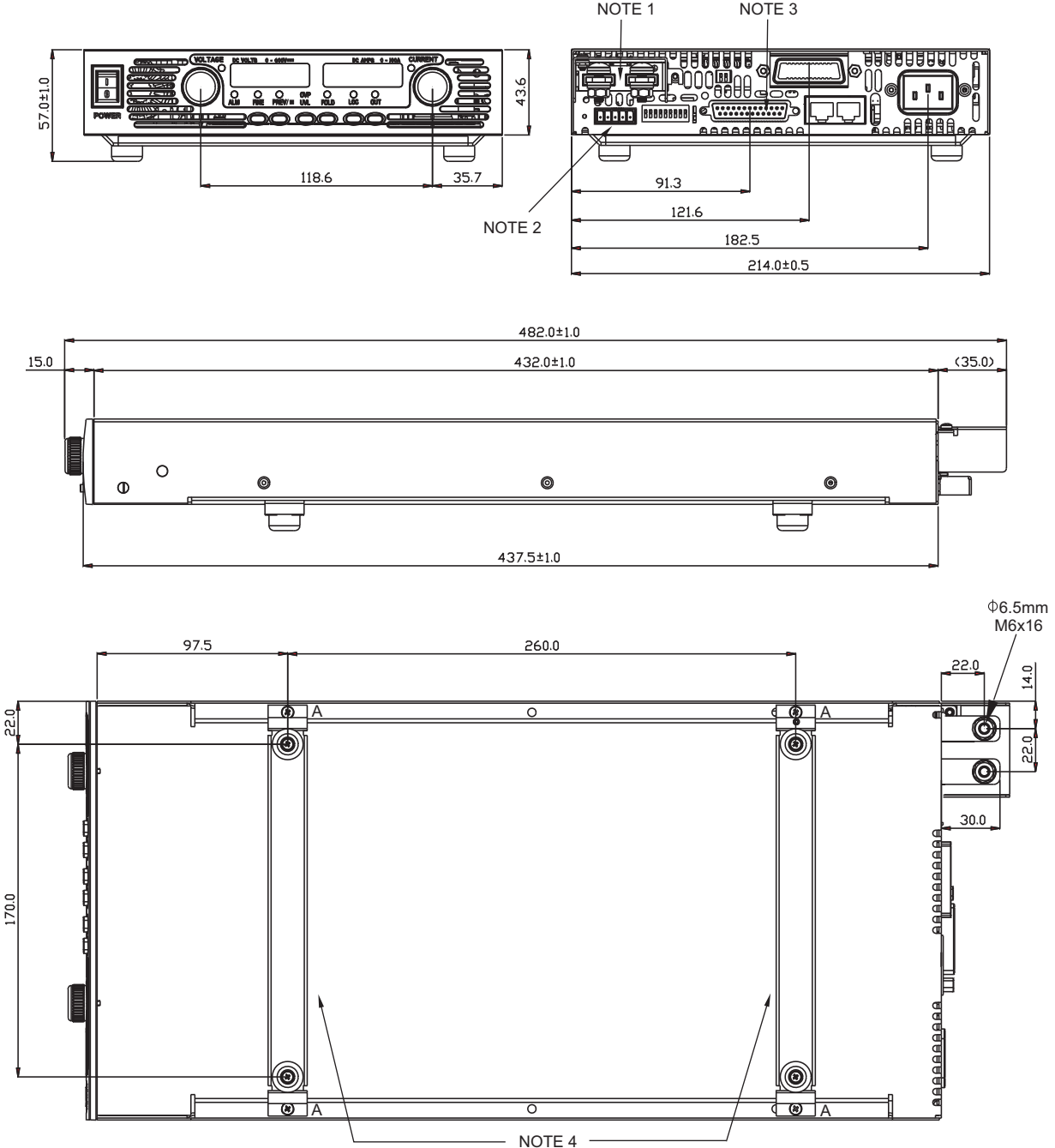

- NOTES:
1. Bus-bars 6V to 60V models
Connector 80V to 600V model
Header Phoenix P/N: GIC 2.5/4-G-7.62
Mating plug Phoenix P/N: GIC 2.5/4-ST-7.62
 2. Mating plug Phoenix P/N: MC1.5/5-ST-3.81
 3. Mating plug AMP P/N: 745211-2
Mating plugs supplied with power supply.
 4. Benchtop assembly x 2 (removable)
Screws: 4 x M3x8 marked "A".
Supplied with the power supply.

Power Supply Identification / Accessories

How to order

GENH	60	-	12.5	-		-	
Series Name	Output Voltage (0~60V)	Output Current (0~12.5A)	Factory Options Option: IEEE IS510 IS420 LAN	AC Cable option Region: E - Europe GB - United Kingdom J - Japan I - Middle East U - North America			

Models GENH750W

Model	Output Voltage VDC	Output Current (A)	Output Power (W)
GENH6-100	0~6V	0~100	600
GENH8-90	0~8V	0~90	720
GENH12.5-60	0~12.5V	0~60	750
GENH20-38	0~20V	0~38	760
GENH30-25	0~30V	0~25	750
GENH40-19	0~40V	0~19	760
GENH60-12.5	0~60V	0~12.5	750
GENH80-9.5	0~80V	0~9.5	760
GENH100-7.5	0~100V	0~7.5	750
GENH150-5	0~150V	0~5	750
GENH300-2.5	0~300V	0~2.5	750
GENH600-1.3	0~600V	0~1.3	780





Factory option

RS-232/RS-485 Interface built-in Standard
 GPIB Interface
 Voltage Programming Isolated Analog Interface
 Current Programming Isolated Analog Interface
 LAN Interface (Complies with **LXI** Class C)

P/N

-
 IEEE
 IS510
 IS420
 LAN

AC Cords sets

Region	Europe	United Kingdom	Japan	Middle East	North America
Output Power	750W	750W	750W	750W	750W
AC Cords	10A/250Vac L=2m	10A/250Vac L=2m	13A/125Vac L=2m	10A/250Vac L=2m	13A/125Vac L=2m
Wall Plug	INT'L 7/VII	BS1363		SI-32	NEMA 5-15P
Power Supply Connector	IEC320-C13 	IEC320-C13 	IEC320-C13 	IEC320-C13 	IEC320-C13 
Part Number	P/N: GEN/E	P/N: GEN/GB	P/N: GEN/J	P/N: GEN/I	P/N : GEN/U

Genesys™

**Programmable DC Power Supplies
750W/1500W in 1U
Built in RS-232 & RS-485 Interface
Advanced Parallel Standard**

**Optional Interfaces:
IEEE488.2 SCPI (GPIB)
Isolated Analog Programming
LXI™ Compliant LAN**



TDK-Lambda

The Genesys™ family of programmable power supplies sets a new standard for flexible, reliable, AC/DC power systems in OEM, Industrial and Laboratory applications.

Features include:

- **High Power Density: 1500W in 1U**
 - **Wide Range Input (85 - 265Vac Continuous, single phase, 47/63Hz)**
 - **Active Power Factor Correction (0.99 typical)**
 - **Output Voltage up to 600V, Current up to 200A**
 - **Built-in RS-232/RS-485 Interface Standard**
 - **Last-Setting Memory**
 - Front Panel Lock selectable from Front Panel or Software
 - High Resolution 16 bit ADCs & DACs
 - Reliable Encoders for Voltage and Current Adjustment
 - Constant Voltage/Constant Current auto-crossover
 - Advanced Parallel reports total current up to four identical units
 - Global Commands for Serial RS-232/RS-485 Interface
 - Independent Remote ON/OFF and Remote Enable/Disable
 - External Analog Programming and Monitoring (user selectable 0-5V & 0-10V)
 - Reliable Modular and SMT Design
 - 19" Rack Mounted ATE and OEM applications
 - Optional Interfaces
 - Isolated Analog Programming and Monitoring Interface (0-5V/0-10V & 4-20mA)
 - IEEE 488.2 SCPI (GPIB) Multi-Drop
 - LXI™** Compliant LAN
 - LabView® and LabWindows® drivers
 - Five Year Warranty
- Worldwide Safety Agency Approvals; CE Mark for LVD and EMC Regulation



Applications

Genesys™ power supplies have been designed to meet the demands of a wide variety of applications.

Test and Measurement

Last-Setting memory simplifies test design and requires no battery backup.

Built-in RS-232/RS-485 gives maximum system flexibility along with 0-5V and 0-10V, selectable analog programming.

Wide range of available inputs allows testing of many different devices.

Semiconductor Burn-in

Safe-Start may be ENABLED to re-start at Output OFF to protect load.

Wide range input (85-265Vac) with Active Power Factor correction rides through input transients easily.

Component Test

High power density, zero stacking and single wire parallel operation give maximum system flexibility.

Laser Diode

OVP is directly set on Voltage Display, assuring accurate protection settings.

Current Limit Fold Back assures load is protected from current surges.

Heater Supplies

Smooth, reliable encoders enhance front panel control.

Remote analog programming is user selectable 0-5V or 0-10V.

RF Amplifiers and Magnets

Robust design assures stable operation under a wide variety of loads.

High linearity in voltage and current mode.

Front Panel Description



1. AC ON/OFF Switch
2. Air Intake allows zero stacking for maximum system flexibility and power density.
3. Reliable encoder controls Output Voltage and sets Address.
4. Volt Display shows Output Voltage and directly displays OVP, UVL and Address settings.
5. Reliable encoder controls Output Current, sets baudrate and Advanced Parallel mode.
6. Current Display shows Output Current and displays baudrate.
7. Function/Status LEDs:
 - Alarm
 - Foldback Mode
 - Fine Control
 - Remote Mode
 - Preview Settings
 - Output On
8. Pushbuttons allow flexible user configuration
 - Coarse and Fine adjustment of Output Voltage/Current and Advanced Parallel Master or Slave
 - Preview settings and set Voltage/Current with Output OFF, Front Panel Lockout
 - Set OVP and UVL Limits
 - Set Current Foldback
 - Local/Remote Mode and select Address and Baudrate
 - Output ON/OFF and Auto-Start/Safe-Start Mode

Rear Panel Description



1. Remote/Local Output Voltage Sense Connections.
2. DIP Switches select 0-5V or 0-10V Programming and other functions.
3. DB25 (Female) connector allows (Non-isolated) Analog Program and Monitor and other functions.
4. RS-485 OUT to other Genesys™ Power Supplies.
5. RS-232/RS-485 IN Remote Serial Programming.
6. Output Connections: Rugged busbars for up to 60V Output; wire clamp connector for Outputs >60V.
7. Exit air assures reliable operation when zero stacked.
8. Wide-Range Input 85-265VAC continuous, 47/63Hz with Active Power Factor Correction (0.99 typical).
AC Input Connector: 750W (IEC320), 1500W (screw terminal-shown).
9. Optional Interface Position for IEEE 488.2 SCPI (shown) or Isolated Analog Interface or LAN Interface.

Genesys™ 750W/1500W Specifications

															750W	1500W
1.0 MODEL	GEN	6-200	8-180	12.5-120	20-76	30-50	40-38	50-30	60-25	80-19	100-15	150-10	300-5	600-2.6		
1.Rated output voltage(*1)	V	6	8	12.5	20	30	40	50	60	80	100	150	300	600		X
2.Rated Output Current(*2)	A	200	180	120	76	50	38	30	25	19	15	10	5	2.6		X
3.Rated Output Power	W	1200	1440	1500	1520	1500	1520	1500	1500	1520	1500	1500	1500	1560		X
4.Efficiency at 100/200Vac (*3)	%	77/79	78/81	81/84	83/86	83/86	84/88	84/88	84/88	84/88	84/88	84/88	83/87	83/87	X	X

1.0 MODEL	GEN	6-100	8-90	12.5-60	20-38	30-25	40-19	---	60-12.5	80-9.5	100-7.5	150-5	300-2.5	600-1.3	X	
1.Rated output voltage (*1)	V	6	8	12.5	20	30	40	---	60	80	100	150	300	600	X	
2.Rated Output Current (*2)	A	100	90	60	38	25	19	---	12.5	9.5	7.5	5	2.5	1.3	X	
3.Rated Output Power	W	600	720	750	760	750	760	---	750	760	750	750	750	780	X	

1.1 CONSTANT VOLTAGE MODE

1.Max.line regulation (0.01% of Vo+ 2mV)(*4)	mV	2.6	2.8	3.3	4	5	6	7	8	10	12	17	32	62	X	X
2.Max load regulation (0.01% of Vo+2mV)(*5)	mV	2.6	2.8	3.3	4	5	6	7	8	10	12	17	32	62	X	X
3.Ripple and noise p-p 20MHz (*9)	mV	60	60	60	60	60	60	60	60	80	80	100	150	300	X	X
4.Ripple r.m.s 5Hz~1MHz (*9)	mV	8	8	8	8	8	8	8	8	8	8	10	25	60	X	X
5.Remote sense compensation/line	V	1	1	1	1	1.5	2	2	3	4	5	5	5	5	X	X
6.Temp. coefficient	PPM/°C	100PPM/°C at rated output voltage, following 30 minutes warm up														
7.Up-prog. response time, 0~Vo Rated	mS	80mS, N.L./F.L., resistive load								150mS, N.L./F.L., resistive load				250	X	X
8.Down-prog response time full-load	mS	10	50				80				150	250	X	X		
9.Down-prog response time no-load	mS	500	600	700	800	900	1000	1100	1100	1200	1500	2000	2500	4000	X	X
10.Transient response time (*8)		Less than 1mSec for models up to and including 100V. 2msec for models above 100V														

1.2 CONSTANT CURRENT MODE

1.Max.line regulation (0.01% of Io+ 2mA)(*4)	mA	12	11	8.0	5.8	4.5	3.9	---	3.25	2.95	2.75	2.5	2.25	2.13	X	
2.Max.load regulation (0.02% of Io+5mA)(*6)	mA	25	23	17	12.6	10	8.8	---	7.5	6.9	6.5	6.0	5.5	5.26	X	
3.Ripple r.m.s 5Hz~1MHz (*7)	mA	200	180	120	76	63	48	---	38	29	23	18	13	8	X	
4.Max.line regulation (0.01% of Io+ 2mA)(*4)	mA	22	20	14	9.6	7.0	5.8	5	4.5	3.9	3.5	3.0	2.5	2.26		X
5.Max.load regulation (0.02% of Io+5mA)(*6)	mA	45	41	29	20.2	15	12.6	11	10	8.8	8.0	7.0	6.0	5.52		X
6.Ripple r.m.s 5Hz~1MHz (*7)	mA	400	360	240	152	125	95	85	75	57	45	35	25	12		X
7.Temp. coefficient	PPM/°C	100PPM/°C from rated output voltage, following 30 minutes warm up														

1.3 PROTECTIVE FUNCTIONS

1. OCP		0~105% Constant Current														X	X
2. OCP Foldback		Output shut down when power supply change from CV to CC. User selectable.														X	X
3. OVP type		Inverter shut-down, manual reset by AC input recycle or by OUT button or by communication port.														X	X
4. OVP trip point		0.5~7.5V 0.5~10V 1~15V 1~24V 2~36V 2~44V 5~57V 5~66V 5~88V 5~110V 5~165V 5~330V 5~660V														X	X
5. Over Temp. Protection		User selectable, latched or non latched														X	X

1.4 ANALOG PROGRAMMING AND MONITORING

1.Vout Voltage Programming		0~100%, 0~5V or 0~10V, user select. Accuracy and linearity: +/-0.5% of rated Vout.														X	X
2.Iout Voltage Programming		0~100%, 0~5V or 0~10V, user select. Accuracy and linearity: +/-1% of rated Iout.														X	X
3.Vout Resistor Programming		0~100%, 0~5/10Kohm full scale, user select. Accuracy and linearity: +/-1% of rated Vout.														X	X
4.Iout Resistor Programming		0~100%, 0~5/10Kohm full scale, user select. Accuracy and linearity: +/-1.5% of rated Iout.														X	X
5.On/Off control (rear panel)		By electrical. Voltage: 0~0.6V/2~15V, or dry contact, user selectable logic														X	X
6.Output Current monitor		0~5V or 0~10V, accuracy: 1%, user selectable														X	X
7.Output Voltage monitor		0~5V or 0~10V, accuracy: 1%, user selectable														X	X
8.Power Supply OK signal		TTL high (4~5V) -OK, 0V-Fail 500ohm series resistance														X	X
9. CV/CC indicator		CV: TTL high (4~5V) source: 10mA, CC: TTL low (0~0.6V), sink current: 10mA														X	X
10. Enable/Disable		Dry contact. Open: off, Short: on. Max. voltage at Enable/Disable in: 6V														X	X
11. Local/Remote analog control		By electrical signal or Open/Short: 0~0.6V or short: Remote, 4~5V or open: Local														X	X
12. Local/Remote analog control indicator		Open collector, Local: Open, Remote: On. Maximum voltage: 30V, maximum sink current: 5mA.														X	X

1.5 FRONT PANEL

1.Control functions		Vout/ Iout manual adjust by separate encoders (coarse and fine adjustment selectable)														X	X
		OVP/UVL manual adjust by Volt. Adjust encoder														X	X
		AC on/off, Output on/off, Re-start modes (auto, safe), Foldback control (CV to CC), Go to local control														X	X
		Address selection by Voltage (or current) adjust encoder. Number of addresses: 31														X	X
		RS232/485 and IEEE488.2 selection by IEEE enable switch and DIP switch														X	X
		Baudrate selection: 1200, 2400, 4800, 9600 and 19,200														X	X
2.Display		Voltage 4 digits, accuracy: 0.5% +/-1 count														X	X
		Current 4 digits, accuracy: 0.5% +/-1 count														X	X
3.Indications		Voltage, Current, Alarm, Fine, Preview, Foldback, Local, Output On, Front Panel Lock														X	X

1.6 Interface RS-232&RS-485 or Optional GPIB / LAN Interface

Model	V	6	8	12.5	20	30	40	50	60	80	100	150	300	600	750W	1500W
1. Remote Voltage Programming (16 bit)															X	X
Resolution (0.012% of Vo Rated)	mV	0.72	0.96	1.50	2.40	3.60	4.80	6	7.2	9.6	12	18	36	72	X	X
Accuracy (0.05%Vo Rated+0.05% of Vo Actual Output)	mV	6.0	8.0	12.5	20	30	40	50	60	80	100	150	300	600	X	X

2. Remote Current Programming (16 bit)																
Resolution (0.012% of Io Rated)	mA	12	10.8	7.2	4.56	3.0	2.28	---	1.50	1.14	0.90	0.60	0.30	0.16	X	
Accuracy (0.1% of Io Rated+0.1% of Io Actual Output)	mA	200	180	120	76	50	38	---	25	19	15	10	5.0	2.6	X	
Resolution (0.012% of Io Rated)	mA	24	21.6	14.4	9.12	6.0	4.56	3.60	3.0	2.28	1.80	1.20	0.60	0.32		X
Accuracy (0.1% of Io Rated+0.1% of Io Actual Output)	mA	400	360	240	152	100	76	60	50	38	30	20	10	5.2		X

3. Readback Voltage																
Resolution (0.012% of Vo Rated)	mV	0.72	0.96	1.50	2.40	3.60	4.80	6.0	7.2	9.6	12	18	36	72	X	X
Accuracy (0.1%Vo Rated+0.1% of Vo Actual Output)	mV	12	16	25	40	60	80	100	120	160	200	300	600	1200	X	X

4. Readback Current																
Resolution (0.012% of Io Rated)	mA	12	10.8	7.2	4.56	3.0	2.28	---	1.50	1.14	0.90	0.60	0.30	0.16	X	
Accuracy (0.3% of Io Rated+0.1% of Io Actual Output)	mA	400	360	240	152	100	76	---	50	38	30	20	10	5.2	X	
Resolution (0.012% of Io Rated)	mA	24	21.6	14.4	9.12	6	4.56	3.60	3.0	2.28	1.80	1.20	0.60	0.32		X
Accuracy (0.3% of Io Rated+0.1% of Io Actual Output)	mA	800	720	480	304	200	152	120	100	76	60	40	20	10.4		X

5. OVP/UVL Programming																
Resolution (0.1% of Vo Rated)	mV	6	8	12	20	30	40	50	60	80	100	150	300	600	X	X
Accuracy (1% of Vo Rated)	mV	60	80	125	200	300	400	500	600	800	1000	1500	3000	6000	X	X

- *1: Minimum voltage is guaranteed to maximum 0.2% of Vo Rated. *3: At maximum output power. *5: From No-load to Full-load, constant input voltage.
 *2: Minimum current is guaranteed to maximum 0.4% of Io Rated. *4: 85~132Vac or 170~265Vac, constant load. *6: For load voltage change, equal to the unit voltage rating, constant input voltage.
 *7: For 6V models the ripple is measured at 2~6V output voltage and full output current. For other models, the ripple is measured at 10~100% output voltage and full output current.
 *8: Time for the output voltage to recover within 0.5% of its rated for a load change 10~90% of rated output, Output set-point: 10~100%.
 *9 For 6V~300V models: measured with JEITA RC-9131A 1:1 probe. For 600V model: measured with 10:1 probe
 Accuracy -Values have been calculated at Vo Rated & Io Rated

General Specifications Genesys™ 750W/1500W

2.1 INPUT CHARACTERISTICS

1. Input voltage/freq. (*1)	85~265Vac continuous, 47~63Hz, single phase
2. Power Factor	0.99 @100/200Vac, rated output power.
3. EN61000-3-2,3 compliance	Complies with EN61000-3-2 class A and EN61000-3-3 at 20~100% output power.
4. Input current 100/200Vac	750W :10.5A/ 5A, 1500W :21A/ 11A
5. Inrush current 100/200Vac	750W :Less than 25A, 1500W :Less than 50A
6. Hold-up time	More than 20mS , 100Vac , at 100% load.

2.2 POWER SUPPLY CONFIGURATION

1. Parallel Operation	Up to 4 units in master/slave mode with single wire current balance connection
2. Series Operation	Up to 2 units. with external diodes. 600V Max to Chassis ground

2.3 ENVIRONMENTAL CONDITIONS

1. Operating temp	0~50°C, 100% load.
2. Storage temp	-20~70°C
3. Operating humidity	30~90% RH (non-condensing).
4. Storage humidity	10~95% RH (non-condensing).
5. Vibration	MIL-810E, method 514.4 , test cond. I-3.3.1. The EUT is fixed to the vibrating surface.
6. Shock	Less than 20G , half sine , 11mSec. Unit is unpacked.
7. Altitude	Operating: 10000ft (3000m), Derat output current by 2%/100m above 2000m, Non operating: 40000ft (12000m).

2.4 EMC

1. Applicable Standards:	
2. ESD	IEC1000-4-2. Air-disch.-8KV, contact disch.-4KV
3. Fast transients	IEC1000-4-4. 2KV
4. Surge immunity	IEC1000-4-5. 1KV line to line, 2KV line to ground
5. Conducted immunity	IEC1000-4-6. 3V
6. Radiated immunity	IEC1000-4-3, 3V/m
7. Conducted emission	EN55022B, FCC part 15J-B, VCCI-B.
8. Radiated emission	EN55022A, FCC part 15-A, VCCI-A.
9. Voltage dips	EN61000-4-11
10. Conducted emission	EN55022B, FCC part 15-B, VCCI-B.
11. Radiated emission	EN55022A, FCC part 15-A, VCCI-A.

2.5 SAFETY

1. Applicable standards:	CE Mark, UL60950, EN60950 listed. Vout<60V: Output is SELV , IEEE/Isolated analog are SELV. 60<Vout<400V: Output is hazardous, IEEE/Isolated analog are SELV. 400<Vout<600V: Output is hazardous, IEEE/Isolated analog are not SELV.
2. Withstand voltage	Vout<60V models :Input-Outputs (SELV): 3.0KVrms 1min, Input-Ground: 2.0KVrms 1min. 60<Vout<600V models: Input-Haz. Output: 2.5KVrms 1min, Input-SELV: 3KVrms 1min. Hazardous Output.-SELV: 1.9KVrms 1min, Hazardous Output-Ground:1.9KVrms 1min. Input-Ground: 2KVrms 1min.
3. Insulation resistance	More than 100Mohm at 25°C , 70% RH, 500Vdc

2.6 MECHANICAL CONSTRUCTION

1. Cooling	Forced air flow: from front to rear. No ventilation holes at the top or bottom of the chassis; Variable fan speed.
2. Dimensions (WxHxD)	W: 422.8mm, H: 43.6mm, D: 432.8mm (excluding connectors, encoders, handles, etc.)
3. Weight	750W : 7Kg (15 Lbs) 1500W : 8.5Kg (18 Lbs)
4. AC Input connector	750W: IEC320 AC Inlet. 1500W: Screw terminal block, Phoenix P/N: FRONT-4-H-7.62 , with strain relief
5. Output connectors	6V to 60V models: Bus-bars (hole Ø 8.5mm). 80V to 600V models: wire clamp connector, Phoenix P/N: FRONT-4-H-7.62

2.7 RELIABILITY SPECS

1. Warranty	5 years.
-------------	----------

*1: For cases where conformance to various safety standards (UL, IEC etc.) is required, to be described as 100-240Vac (50/60Hz).
All specifications subject to change without notice.

Outline Drawing Genesys™ 750W/1500W Units

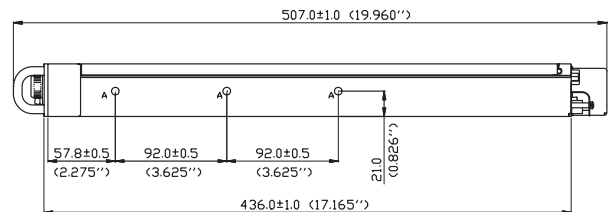
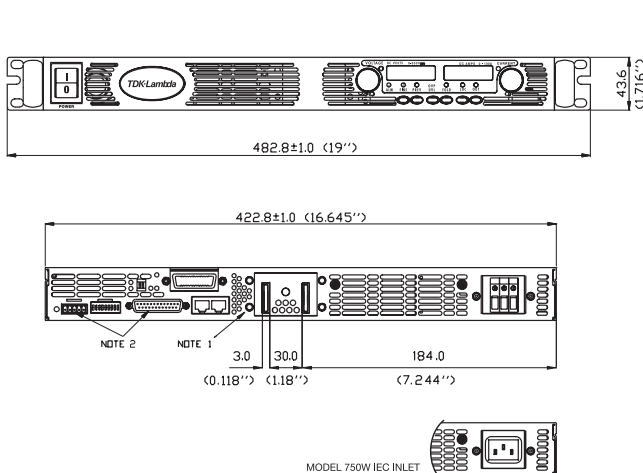

NOTE

1. Bus bars for 6v to 60v models (shown)
Wire clamp connector for 80V to 600V models
2. Plug connectors included with the power supply
3. Chassis slides mounting holes #10-32 marked "A"
GENERAL DEVICES P/N: C-300-S-116 or equivalent

Genesys™ Power Parallel and Series Configurations

Parallel operation - Master/Slave:

Active current sharing allows up to four identical units to be connected in an auto-parallel configuration for four times the output power.

In Advanced Parallel Master/Slave Mode, total current is programmed and reported by the Master, Up to four supplies act as one.



Series operation

Up to two units may be connected in series to increase the output voltage or to provide bipolar output. (Max 600V to Chassis Ground).

Remote Programming via RS-232 & RS-485 Interface

Standard Serial Interface allows chain control of up to 31 power supplies on the same bus with built-in RS-232 & RS-485 Interface.

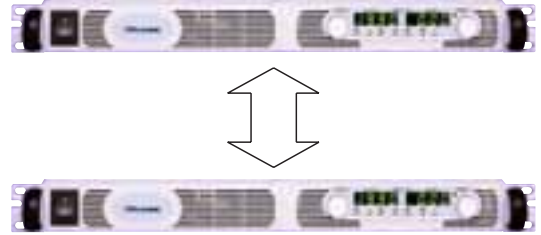
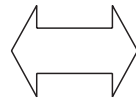

Programming Options (Factory installed)

Digital Programming via IEEE Interface

P/N: IEEE

- IEEE 488.2 SCPI Compliant
- Program Voltage
- Measure Voltage
- Over Voltage setting and shutdown
- Error and Status Messages
- **New! Multi-Drop**
 - Allows IEEE Master to control up to 31 slaves over RS-485 daisy-chain
 - Only the Master needs be equipped with IEEE Interface
- Program Current
- Measure Current
- Current Foldback shutdown

Isolated Analog Programming

Four Channels to Program and Monitor Voltage and Current. Isolation allows operation with floating references in harsh electrical environments. Choose between programming with Voltage or Current. Connection via removable terminal block: Phoenix MC1,5/8-ST-3.81.

- Voltage Programming, user-selectable 0-5V or 0-10V signal.
 - Power supply Voltage and Current Programming Accuracy $\pm 1\%$
 - Power supply Voltage and Current Monitoring Accuracy $\pm 1.5\%$
- Current Programming with 4-20mA signal.
 - Power supply Voltage and Current Programming Accuracy $\pm 1\%$
 - Power supply Voltage and Current Monitoring Accuracy $\pm 1.5\%$

P/N: IS510

P/N: IS420

LAN Interface

LXI™ Compliant to Class C

P/N: LAN

- Meets all LXI-C Requirements
- Address Viewable on Front Panel
- Fixed and Dynamic Addressing
- Compatible with most standard Networks
- VISA & SCPI Compatible
- LAN Fault Indicators
- Auto-detects LAN Cross-over Cable
- Fast Startup

Power Supply Identification / Accessories

How to order

GEN	600	-	2.6	-	-
Series Name	Output Voltage (0~600V)	Output Current (0~2.6A)	Option: IEEE IS510 IS420 LAN	Factory Options	AC Cable option is 750W only Region: E - Europe GB - United Kingdom J - Japan I - Middle East U - North America

Models 750/1500W

Model	Output Voltage VDC	Output Current (A)	Output Power (W)
GEN6-100	0~6V	0~100	600
GEN6-200		0~200	1200
GEN8-90	0~8V	0~90	720
GEN8-180		0~180	1440
GEN12.5-60	0~12.5V	0~60	750
GEN12.5-120		0~120	1500
GEN20-38	0~20V	0~38	760
GEN20-76		0~76	1520
GEN30-25	0~30V	0~25	750
GEN30-50		0~50	1500
GEN40-19	0~40V	0~19	760
GEN40-38		0~38	1520





Model	Output Voltage VDC	Output Current (A)	Output Power (W)
GEN50-30	0~50V	0~30	1500
GEN60-12.5	0~60V	0~12.5	750
GEN60-25		0~25	1500
GEN80-9.5	0~80V	0~9.5	760
GEN80-19		0~19	1520
GEN100-7.5	0~100V	0~7.5	750
GEN100-15		0~15	1500
GEN150-5	0~150V	0~5	750
GEN150-10		0~10	1500
GEN300-2.5	0~300V	0~2.5	750
GEN300-5		0~5	1500
GEN600-1.3	0~600V	0~1.3	780
GEN600-2.6		0~2.6	1560

Factory option

RS-232/RS-485 Interface built-in Standard	-
GPIB Interface	IEEE
Voltage Programming Isolated Analog Interface	IS510
Current Programming Isolated Analog Interface	IS420
LAN Interface (Complies with LXI ™ Class C)	LAN

P/N

AC Cords sets (750W only)

Region	Europe	United Kingdom	Japan	Middle East	North America
Output Power	750W	750W	750W	750W	750W
AC Cords	10A/250Vac L=2m	10A/250Vac L=2m	13A/125Vac L=2m	10A/250Vac L=2m	13A/125Vac L=2m
Wall Plug	INT'L 7/VII	BS1363		SI-32	NEMA 5-15P
Power Supply Connector	IEC320-C13	IEC320-C13	IEC320-C13	IEC320-C13	IEC320-C13
					
Part Number	P/N: GEN/E	P/N: GEN/GB	P/N: GEN/J	P/N: GEN/I	P/N : GEN/U

Accessories

1. Communication cable

RS-232/RS-485 Cable is used to connect the power supply to the PC Controller.

Mode	RS-485	RS-232	RS-232
PC Connector	DB-9F	DB-9F	DB-25F
Communication Cable	Shield Ground L=2m	Shield Ground L=2m	Shield Ground L=2m
Power Supply Connector	EIA/TIA-568A (RJ-45)	EIA/TIA-568A (RJ-45)	EIA/TIA-568A (RJ-45)
P/N	GEN/485-9	GEN/232-9	GEN/232-25

2. Serial link cable*

Daisy-chain up to 31 Genesys™ power supplies.

Mode	Power Supply Connector	Communication Cable	P/N
RS-485	EIA/TIA-568A (RJ-45)	Shield Ground L=50cm	GEN/RJ45

* Included with power supply

Genesys™

Programmable DC Power Supplies
2.4KW in 1U
Built in RS-232 & RS-485 Interface
Advanced Parallel Standard

Optional Interfaces:
LXI Compliant LAN
IEEE488.2 SCPI (GPIB)
Isolated Analog Programming



TDK-Lambda

The Genesys™ family of programmable power supplies sets a new standard for flexible, reliable, AC/DC power systems in OEM, Industrial and Laboratory applications.

Features include:

- High Power Density 2.4kW in 1U
- Wide Range of popular worldwide AC inputs, 1 ϕ (230VAC) & 3 ϕ (208VAC)
- Active Power Factor Correction (Single-Phase & Three-Phase AC Input)
- Output Voltage up to 600V, Current up to 300A
- Built-in RS-232/RS-485 Interface Standard
- Global Commands for Serial RS-232/RS-485 Interface
- Auto-Re-Start / Safe-Start: user selectable
- Last-Setting Memory
- High Resolution 16 bit ADCs & DACs
- Low Ripple & Noise
- Front Panel Lock selectable from Front Panel or Software
- Reliable Encoders for Voltage and Current Adjustment
- Constant Voltage/Constant Current auto-crossover
- Parallel Operation with Active Current Sharing; up to four identical units.
- Advanced Parallel Master / Slave. Total Current is Programmed and Measured via the Master.
- Independent Remote ON/OFF and Remote Enable/Disable
- External Analog Programming and Monitoring (user selectable 0-5V & 0-10V)
- Reliable Modular and SMT Design
- 19" Rack Mount capability for ATE and OEM applications
- Optional Interfaces
 - Isolated Analog Programming and Monitoring Interface (0-5V/0-10V & 4-20mA)
 - IEEE 488.2 SCPI (GPIB) Multi-Drop
 - LXI** Compliant LAN
- LabView® and LabWindows® drivers
- Five Year Warranty

Worldwide Safety Agency Approvals; CE Mark for LVD and EMC Regulation



Applications

Genesys™ power supplies have been designed to meet the demands of a wide variety of applications. System Designers will appreciate new, standard, remote programming features such as Global commands. Also, new high-speed status monitoring is available for the RS-485 bus.

Test Systems using the IEEE-488 bus may achieve significant cost savings by incorporating the Optional IEEE Multi-Drop Interface for a Master and up to 30 RS-485 Multi-Drop Slaves.

Higher power systems can be configured with up to four 2.4kW modules. Each module is 1U with zero space between them (zero stack).

Flexible configuration is provided by the complete Genesys™ Family: 1U 750W Half-Rack, 1U 750W and 1500W Full-Rack, 2U 3.3kW & 5kW. All are identical in Front Panel, Rear Panel Analog, and all Digital Interface Commands. A wide variety of outputs allows testing of many different devices.

OEM Designers have a wide variety of Inputs and Outputs from which to select depending on application and location.

Front Panel Description



1. ON/OFF Switch
2. Air Intake allows zero stacking for maximum system flexibility and power density.
3. Reliable encoder controls Output Voltage, Address, OVP and UVL settings.
4. Volt Display shows Output Voltage and directly displays OVP, UVL and Address settings.
5. Reliable encoder controls Output Current, sets baudrate and Advanced Parallel mode.
6. Current Display shows Output Current and displays Baud rate. Displays total current in Parallel Master/Slave Mode
7. Function/Status LEDs:
 - Alarm
 - Foldback Mode
 - Fine Control
 - Remote Mode
 - Preview Settings
 - Output On
8. Pushbuttons allow flexible user configuration
 - Coarse and Fine adjustment of Output Voltage/Current and Advanced Parallel Master or Slave select.
 - Preview settings and set Voltage/Current with Output OFF, Front Panel Lock
 - Parallel Master/Slave
 - Set OVP and UVL Limits
 - Set Current Foldback Protection
 - Go to Local Mode and select Address and Baud rate
 - Output ON/OFF and Auto-Re-Start/Safe-Start Mode

Rear Panel Description



1. Remote/Local Output Voltage Sense Connections.
2. DIP Switches select 0-5V or 0-10V Programming and other functions.
3. DB25 (Female) connector allows (Non-isolated) Analog Program and Monitor and other functions.
4. RS-485 OUT to other Genesys™ Power Supplies.
5. RS-232/RS-485 IN Remote Serial Programming.
6. Output Connections: Rugged busbars (shown) for up to 100V Output; wire clamp connector for Outputs >100V.
7. Exit air assures reliable operation when zero stacked.
8. Input: 230VAC Single Phase (shown), 208 VAC Three Phase, 50/60 Hz
AC Input Connector: Phoenix P/N: FRONT-4-H-7.62.
9. Optional Interface Position for IEEE 488.2 SCPI (shown) or Isolated Analog Interface or LAN Interface.
10. Auxiliary Output Voltage.

Genesys™ 2.4kW Specifications

1.0 MODEL	GEN	8-300	10-240	16-150	20-120	30-80	40-60	60-40	80-30	100-24	150-16	300-8	600-4
1. Rated output voltage(*1)	V	8	10	16	20	30	40	60	80	100	150	300	600
2. Rated Output Current(*2)	A	300	240	150	120	80	60	40	30	24	16	8	4
3. Rated Output Power	W	2400	2400	2400	2400	2400	2400	2400	2400	2400	2400	2400	2400
4. Development Priority	---	A	C	B	C	B	B	A	C	C	A	B	A

1.1 CONSTANT VOLTAGE MODE

1. Max. line regulation (0.01% of rated Vo+2mV)(*6)	mV	2.8	3	3.6	4	5	6	8	10	12	17	32	62
2. Max. load regulation (0.015% of rated Vo+5mV)(*7)	mV	6.2	6.5	7.4	8	9.5	11	14	17	20	27.5	50	95
3. Ripple and noise p-p 20MHz (*8)	mV	60	60	60	60	60	60	60	80	80	100	150	300
4. Ripple r.m.s 5Hz~1MHz	mV	8	8	8	8	8	8	8	8	8	25	35	75
5. Remote sense compensation/wire	V	2	2	2	2	5	5	5	5	5	5	5	5
6. Temp. coefficient	PPM/°C	100PPM/°C of rated output voltage, following 30 minutes warm-up											
7. Temp. stability		0.05% of rated Vout over 8hrs interval following 30 minutes warm-up. Constant line, load & temp.											
8. Warm-up drift		Less than 0.05% of rated output voltage+2mV over 30 minutes following power On.											
9. Up-prog. response time, 0-Vo Rated (*9)	mS	15mS	30mS						60mS			100mS	
10. Down-prog response time			30						80			100	
	Full-load (*9)	mS	10										100
	No-load (*10)	mS	500	600	700	800	900	1000	1100	1200	1500	2500	3000
11. Transient response time	mS	Time for output voltage to recover within 0.5% of its rated output for a load change 10-90% of rated output current. Output set-point: 10-100%, local sense. Less than 1mSec for models up to and including 100V. 2msec for models above 100V											

1.2 CONSTANT CURRENT MODE

1. Max. line regulation (0.01% of Io rated+2mA)(*6)	mA	32	26	17	14	10	8	6	5	4.4	3.6	2.8	2.4
2. Max. load regulation (0.02% of Io rated+5mA)(*11)	mA	65	53	35	29	21	17	13	11	9.8	8.2	6.6	5.8
3. Ripple r.m.s 5Hz~1MHz. (*12)	mA	1200	960	600	480	220	120	70	50	40	30	15	7
4. Temp. coefficient	PPM/°C	100PPM/°C from rated output current, following 30 minutes warm-up.											
5. Temp. stability		0.05% of rated Iout over 8hrs. interval following 30minutes warm-up. Constant line, load & temperature.											
6. Warm-up drift		8V-20V models: Less than ±0.5% of rated output current over 30 minutes following power On. 30V-600V models: Less than ±0.25% of rated output current over 30 minutes following power On.											

1.3 PROTECTIVE FUNCTIONS

1. OCP	0~105% Constant Current
2. OCP Foldback	Output shut down when power supply change from CV to CC. User selectable.
3. OVP type	Inverter shut-down, manual reset by AC input recycle or by OUT button or by communication port command.
4. OVP trip point	0.5-10V 0.5-12V 1-19V 1-24V 2-36V 2-44V 5-66V 5-88V 5-110V 5-165V 5-330V 5-660V
5. Output Under Voltage Limit	Preset by front panel or communication port. Prevents from adjusting Vout below limit.
6. Over Temp. Protection	User selectable, latched or non-latched.

1.4 ANALOG PROGRAMMING AND MONITORING

1. Vout Voltage Programming	0~100%, 0-5V or 0-10V, user select. Accuracy and linearity: ±0.5% of rated Vout.
2. Iout Voltage Programming (*13)	0~100%, 0-5V or 0-10V, user select. Accuracy and linearity: ±1% of rated Iout.
3. Vout Resistor Programming	0~100%, 0-5/10Kohm full scale, user select. Accuracy and linearity: ±1% of rated Vout.
4. Iout Resistor Programming (*13)	0~100%, 0-5/10Kohm full scale, user select. Accuracy and linearity: ±1.5% of rated Iout.
5. On/Off control (rear panel)	By electrical. Voltage: 0-0.6V/2-15V, or dry contact, user selectable logic.
6. Output Current monitor (*13)	0-5V or 0-10V, Accuracy: ±1%, user selectable.
7. Output Voltage monitor	0-5V or 0-10V, Accuracy: ±1%, user selectable.
8. Power Supply OK signal	TTL high (4-5V) -OK, 0V-Fail 500ohm series resistance.
9. CV/CC Indicator	Open collector, CC mode: On, CV mode: Off, Maximum voltage: 30V, maximum sink current: 10mA
10. Enable/Disable	Dry contact. Open: off, Short: on. Max. voltage at Enable/Disable in: 6V.
11. Local/Remote analog control	By electrical signal or Open/Short: 0-0.6V or short: Remote, 2-15V or open: Local.
12. Local/Remote analog control Indicator	Open collector, Local: Off, Remote: On. Maximum voltage: 30V, maximum sink current: 10mA.

1.5 FRONT PANEL

1. Control functions	Vout/ Iout manual adjust by separate encoders (coarse and fine adjustment selectable). OVP/UVL manual adjust by Volt. Adjust encoder. On/Off, Output on/off, Re-start modes (auto, safe), Foldback control (CV to CC), Go to local control. Address selection by Voltage (or current) adjust encoder. Number of addresses: 31. Re-start modes (automatic restart, safe mode). Baud rate selection: 1200, 2400, 4800, 9600 and 19,200.
2. Display	Voltage: 4 digits, Accuracy: 0.5% of rated output Voltage ±1 count. Current: 4 digits, Accuracy: 0.5% of rated output current ±1 count.
3. Indications	Voltage, Current, Alarm, Fine, Preview, Foldback, Local, Output On, Front Panel Lock, CV/CC.

1.6 Interface RS-232&RS-485 or Optional GPIB / LAN Interface

Model	V	8	10	16	20	30	40	60	80	100	150	300	600
1. Remote Voltage Programming (16 bit)													
Resolution (0.012% of Vo Rated)	mV	0.96	1.2	1.92	2.4	3.6	4.8	7.2	9.6	12	18	36	72
Accuracy (0.05%Vo Rated+0.05% of Vo Actual Output)	mV	8	10	16	20	30	40	60	80	100	150	300	600
2. Remote Current Programming (16 bit)													
Resolution (0.012% of Io Rated)	mA	36	28.8	18	14.4	9.6	7.2	4.8	3.6	2.88	1.92	0.96	0.48
Accuracy (0.2% of Io Rated+0.1% of Io Actual Output) (*13)	mA	900	720	450	360	240	180	120	90	72	48	24	12
3. Readback Voltage													
Resolution (0.012% of Vo Rated)	mV	0.96	1.2	1.92	2.4	3.6	4.8	7.2	9.6	12	18	36	72
Accuracy (0.1%Vo Rated+0.1% of Vo Actual Output)	mV	16	20	32	40	60	80	120	160	200	300	600	1200
4. Readback Current													
Resolution (0.012% of Io Rated)	mA	36	28.8	18	14.4	9.6	7.2	4.8	3.6	2.88	1.92	0.96	0.48
Accuracy (0.3% of Io Rated+0.1% of Io Actual Output) (*13)	mA	1200	960	600	480	320	240	160	120	96	64	32	16
5. OVP/UVL Programming													
Resolution (0.1% of Vo Rated)	mV	8	10	16	20	30	40	60	80	100	150	300	600
Accuracy (1% of Vo Rated)	mV	80	100	160	200	300	400	600	800	1000	1500	3000	6000

*1: Minimum voltage is guaranteed to maximum 0.2% of rated output voltage.

*2: Minimum current is guaranteed to maximum 0.4% of rated output current.

*3: For cases where conformance to various safety standards (UL, IEC, etc) is required, to be described as 190-240Vac (50/60Hz) for 3-Phase 208V models.

*4: 3-Phase 208V models: At 208Vac input voltage. With rated output power.

*5: Not including EMI filter inrush current, less than 0.2mSec.

*6: 3-Phase 208V models: 170-265Vac, constant load.

*7: From No-Load to Full-Load, constant input voltage. Maximum drop in Remote Sense.

*8: For 8V-300V models: Measured with JEITA RC-9131A (1:1) probe. For 600V model: Measured with 10:1 probe.

*9: From 10% to 90% or 90% to 10% of Rated Output Voltage, with rated, resistive load.

*10: From 90% to 10% of Rated Output Voltage.

*11: For load voltage change, equal to the unit voltage rating, constant input voltage.

*12: For 8V-16V models the ripple is measured from 2V to rated output voltage and rated output current. For other models, the ripple is measured at 10-100% of rated output voltage and rated output current.

*13: The Constant Current programming readback and monitoring accuracy does not include the warm-up and Load regulation thermal drift.

General Specifications Genesys™ 2.4kW

2.1 INPUT CHARACTERISTICS

	GEN	8-300	10-240	16-150	20-120	30-80	40-60	60-40	80-30	100-24	150-16	300-8	600-4
1. Input voltage/freq. (*3)	VAC	Single Phase, 230V models: 170-265Vac, 47-63Hz 3-Phase, 208V models: 170-265Vac, 47-63Hz											
2. Maximum Input current at 100% load	A	17	17	17	16.3	16.3	16.3	16.3	16.3	16.3	16.3	16.3	16.3
3. Power Factor (Typ)	A	10.5	10.5	10.5	9.8	9.8	9.8	9.8	9.8	9.8	9.8	9.8	9.8
4. Efficiency (*4)	%	Single Phase models: 0.99@230Vac, rated output power. 3-Phase models: 0.94@208 Vac, rated output power.											
5. Inrush Current (*5)	A	84	84	84	86	86	88	88	88	88	88	88	88
6. Hold-up time (Typ)	mS	10mSec for Single-Phase and 3-phase 208V models. Rated output power.											

2.2 AUXILIARY OUTPUT

1. 15V output	15V±5%, 0.2A Max load, Ripple & Noise 50mVp-p. Referenced internally to the negative output potential.
2. 5V output	5V±5%, 0.2A Max load, Ripple & Noise 50mVp-p. Referenced internally to IF_com potential.

2.3 POWER SUPPLY CONFIGURATION

1. Parallel Operation	Up to 4 identical units in master/slave mode
2. Series Operation	Up to 2 identical units. with external diodes. 600V Max to Chassis ground

2.4 ENVIRONMENTAL CONDITIONS

1. Operating temp	0-50°C, 100% load.
2. Storage temp	-20-85°C
3. Operating humidity	20-90% RH (non-condensing).
4. Storage humidity	10-95% RH (non-condensing).
5. Vibration	MIL-810F, method 514.5, The EUT is fixed to the vibrating surface.
6. Shock	Less than 20G, half sine, 11mSec. Unit is unpacked.
7. Altitude	Operating: 10000ft (3000m), Derate output current by 2%/100m above 2000m, Alternatively, derate maximum ambient temp. by 1°C/100m above 2000m. Non operating: 40000ft (12000m).
8. RoHS Compliance	Complies with the requirements of RoHS directive.

2.5 EMC

1. Applicable Standards:	
2. ESD	IEC1000-4-2. Air-disch.-8KV, contact disch.-4KV
3. Fast transients	IEC1000-4-4. 2KV
4. Surge immunity	IEC1000-4-5. 1KV line to line, 2KV line to ground
5. Conducted immunity	IEC1000-4-6, 3V
6. Radiated immunity	IEC1000-4-3, 3V/m
7. Magnetic field immunity	EN61000-4-8, 1A/m
8. Voltage dips	EN61000-4-11
9. Conducted emission	EN55022A, FCC part 15-A, VCCI-A.
10. Radiated emission	EN55022A, FCC part 15-A, VCCI-A.

2.6 SAFETY

1. Applicable standards:	CE Mark, UL60950, EN60950 listed. Vout≤40V: Output is SELV, IEEE/Isolated analog are SELV. 40<Vout≤400V: Output is hazardous, IEEE/Isolated analog are SELV. 400<Vout≤600V: Output is hazardous, IEEE/Isolated analog are not SELV.
2. Withstand voltage	Vout≤40V models: Input-Outputs (SELV): 4242VDC 1min, Input-Ground: 2828VDC 1min. 40<Vout≤100V models: Input-Haz. Output: 2600VDC 1min, Input-SELV: 4242VDC 1min. Hazardous Output.-SELV: 1900VDC 1min, Hazardous Output-Ground: 1200VDC 1min. Input-Ground: 2828VDC 1min. 100<Vout≤600V models: Input-Haz. Output: 4000VDC 1min, Input-SELV: 4242VDC 1min. Hazardous Output.-SELV: 3550VDC 1min. Hazardous Output-Ground: 2670VDC 1min. Input-Ground: 2828VDC 1min.
3. Insulation resistance	More than 100Mohm at 25°C, 70% RH.

2.7 MECHANICAL CONSTRUCTION

1. Cooling	Forced air flow: from front to rear. No ventilation holes at the top or bottom of the chassis; Variable fan speed.
2. Dimensions (WxHxD)	W: 423mm, H: 43.6mm, D: 432.8mm (excluding connectors, encoders, handles, etc.)
3. Weight	10 kg.
4. AC Input connector (with Protective Cover)	Single Phase, 230V models, wire clamp connector, Phoenix P/N: FRONT-4-H-7.62, with Strain relief. 3-Phase, 208V models, wire clamp connector, Phoenix P/N: FRONT-4-H-7.62, with Strain relief.
5. Output connectors	8V to 100V models: Bus-bars (hole Ø 8.5mm). 150V to 600V models: wire clamp connector, Phoenix P/N: FRONT-4-H-7.62 Auxiliary output Header: IMC 1.5/7-G-3.81, Plug: IMC 1.5/7-ST-3.81 (Phoenix Contact).

2.8 RELIABILITY SPECS

1. Warranty	5 years.
-------------	----------

All specifications subject to change without notice.

Outline Drawing Genesys™ 2.4kW Units

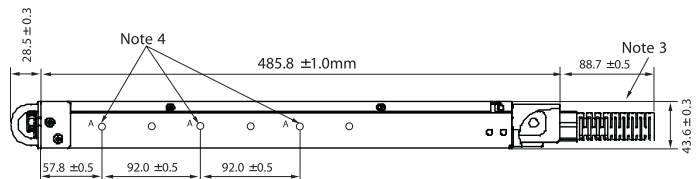
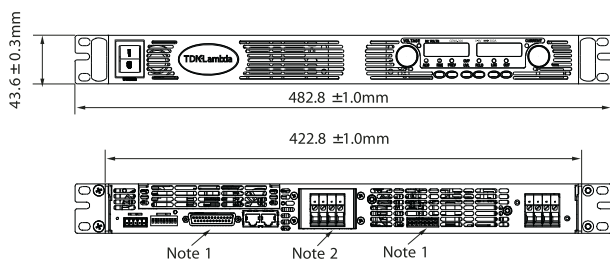

NOTE

1. Mating plug supplied with power supply.
2. Bus-bars for 8V to 100V models. See detail.
3. AC cable strain relief supplied with power supply.
4. Chassis slides mounting holes #10-32 marked "A".
GENERAL DEVICES P/N: CC3001-00-S160 or equivalent.

Genesys™ Power Parallel and Series Configurations

Parallel operation - Master/Slave:

Active current sharing allows up to four identical units to be connected in an auto-parallel configuration for four times the output power.

In Advanced Parallel Master/Slave Mode, total current is programmed and reported by the Master, Up to four supplies act as one.



Series operation

Up to two units may be connected in series to increase the output voltage or to provide bipolar output. (Max 600V to Chassis Ground).

Remote Programming via RS-232 & RS-485 Interface

Standard Serial Interface allows daisy-chain control of up to 31 power supplies on the same communication bus with built-in RS-232 & RS-485 Interface.

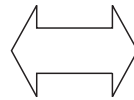

Programming Options (Factory installed)

Digital Programming via IEEE Interface

P/N: IEEE

- IEEE 488.2 SCPI Compliant
- Program Voltage
- Measure Voltage
- Over Voltage setting and shutdown
- Error and Status Messages
- **New! Multi-Drop**
 - Allows IEEE Master to control up to 31 slaves over RS-485 daisy-chain
 - Only the Master needs be equipped with IEEE Interface
- Program Current
- Measure Current
- Current Foldback shutdown

Isolated Analog Programming

Four Channels to Program and Monitor Voltage and Current. Isolation allows operation with floating references in harsh electrical environments. Choose between programming with Voltage or Current. Connection via removable terminal block: Phoenix MC1,5/8-ST-3.81.

- Voltage Programming, user-selectable 0-5V or 0-10V signal.
 - Power supply Voltage and Current Programming Accuracy $\pm 1\%$
 - Power supply Voltage and Current Monitoring Accuracy $\pm 1.5\%$
- Current Programming with 4-20mA signal.
 - Power supply Voltage and Current Programming Accuracy $\pm 1\%$
 - Power supply Voltage and Current Monitoring Accuracy $\pm 1.5\%$

P/N: IS510

P/N: IS420

LAN Interface

LXI Compliant to Class C

P/N: LAN

- Meets all LXI-C Requirements
- Address Viewable on Front Panel
- Fixed and Dynamic Addressing
- Compatible with most standard Networks
- VISA & SCPI Compatible
- LAN Fault Indicators
- Auto-detects LAN Cross-over Cable
- Fast Startup

Power Supply Identification / Accessories

How to order

GEN	8	-	300	-		
Series Name	Output Voltage (0~8V)	Output Current (0~300A)	Factory Options: Option: IEEE IS510 IS420 LAN	Factory AC Input Options: 1P230 (Single Phase 170~265VAC) 3P208 (Three Phase 170~265VAC)		

Models 2.4kW

Model	Output Voltage VDC	Output Current (A)	Output Power (W)
GEN 8-300	0~8V	0~300	2400
GEN 10-240	0~10V	0~240	2400
GEN 16-150	0~15V	0~150	2400
GEN 20-120	0~20V	0~120	2400
GEN 30-80	0~30V	0~80	2400
GEN 40-60	0~40V	0~60	2400

Model	Output Voltage VDC	Output Current (A)	Output Power (W)
GEN 60-40	0~60V	0~40	2400
GEN 80-30	0~80V	0~30	2400
GEN 100-24	0~100V	0~24	2400
GEN 150-16	0~150V	0~16	2400
GEN 300-8	0~300V	0~8	2400
GEN 600-4	0~600V	0~4	2400

Factory option

RS-232/RS-485 Interface built-in Standard	P/N
GPIB Interface	-
Voltage Programming Isolated Analog Interface	IEEE
Current Programming Isolated Analog Interface	IS510
LAN Interface (Complies with LXI Class C)	IS420
	LAN

Accessories

1. Serial Communication cable

RS-232/RS-485 cable is used to connect the power supply to the Host PC.

Mode	RS-485	RS-232	RS-232
PC Connector	DB-9F	DB-9F	DB-25F
Communication Cable	Shield Ground L=2m	Shield Ground L=2m	Shield Ground L=2m
Power Supply Connector	EIA/TIA-568A (RJ-45)	EIA/TIA-568A (RJ-45)	EIA/TIA-568A (RJ-45)
P/N	GEN/485-9	GEN/232-9	GEN/232-25

2. Serial link cable*

Daisy-chain up to 31 Genesys™ power supplies.

Mode	Power Supply Connector	Communication Cable	P/N
RS-485	EIA/TIA-568A (RJ-45)	Shield Ground L=50cm	GEN/RJ45

* Included with power supply



Also available, Genesys™
1U Half Rack 750W
1U full Rack 750W/1500W/2400W
2U full Rack 3300W/5000W

Genesys™

Programmable DC Power Supplies
3.3KW in 2U
Built in RS-232 & RS-485 Interface
Advanced Parallel Standard

Optional Interfaces:
IEEE488.2 SCPI (GPIB)
Isolated Analog Programming
LXI™ Compliant LAN



TDK-Lambda

The Genesys™ family of programmable power supplies sets a new standard for flexible, reliable, AC/DC power systems in OEM, Industrial and Laboratory applications.

Features include:

- High Power Density 3.3kW in 2U
- Wide Range of popular worldwide AC inputs, 1 ϕ (230VAC) & 3 ϕ (208VAC, 400VAC)
- Active Power Factor Correction (Single-Phase & Three-Phase AC Input)
- Output Voltage up to 600V, Current up to 400A
- Built-in RS-232/RS-485 Interface Standard
- Global Commands for Serial RS-232/RS-485 Interface
- Auto-Re-Start / Safe-Start: user selectable
- Last-Setting Memory
- High Resolution 16 bit ADCs & DACs
- Low Ripple & Noise
- Front Panel Lock selectable from Front Panel or Software
- Reliable Encoders for Voltage and Current Adjustment
- Constant Voltage/Constant Current auto-crossover
- Parallel Operation with Active Current Sharing; up to four identical units.
- Advanced Parallel Master / Slave. Total Current is Programmed and Measured via the Master.
- Independent Remote ON/OFF and Remote Enable/Disable
- External Analog Programming and Monitoring (user selectable 0-5V & 0-10V)
- Reliable Modular and SMT Design
- 19" Rack Mount capability for ATE and OEM applications
- Optional Interfaces
 - Isolated Analog Programming and Monitoring Interface (0-5V/0-10V & 4-20mA)
 - IEEE 488.2 SCPI (GPIB) Multi-Drop
 - LXI™ Compliant LAN
- LabView® and LabWindows® drivers
- Five Year Warranty

Worldwide Safety Agency Approvals; CE Mark for LVD and EMC Regulation



Applications

Genesys™ power supplies have been designed to meet the demands of a wide variety of applications. System Designers will appreciate new, standard, remote programming features such as Global commands. Also, new high-speed status monitoring is available for the RS-485 bus.

Test Systems using the IEEE-488 bus may achieve significant cost savings by incorporating the Optional IEEE Multi-Drop Interface for a Master and up to 30 RS-485 Multi-Drop Slaves.

Higher power systems can be configured with up to four 3.3kW modules. Each module is 2U with zero space between them (zero stack).

Flexible configuration is provided by the complete Genesys™ Family: 1U 750W Half-Rack, 1U 750W and 1500W Full-Rack. All are identical in Front Panel, Rear Panel Analog, and all Digital Interface Commands.

OEM Designers have a wide variety of Inputs and Outputs from which to select depending on application and location.

Front Panel Description

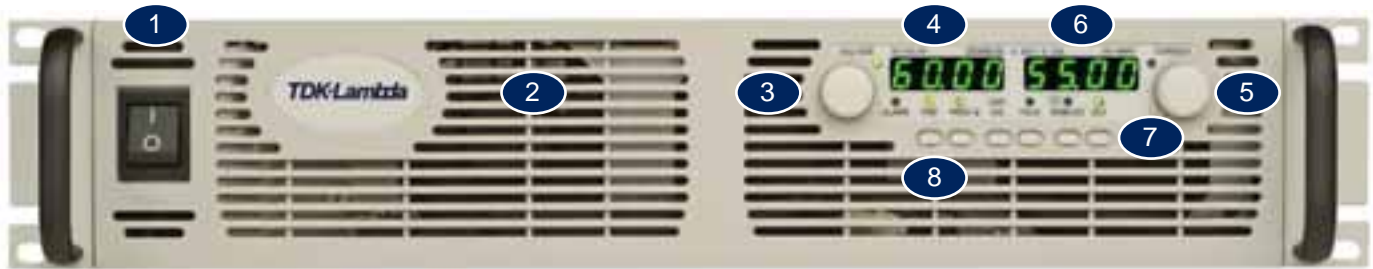

1. ON/OFF Switch
2. Air Intake allows zero stacking for maximum system flexibility and power density.
3. Reliable encoder controls Output Voltage, Address, OVP and UVL settings.
4. Volt Display shows Output Voltage and directly displays OVP, UVL and Address settings.
5. Reliable encoder controls Output Current, sets baudrate and Advanced Parallel mode.
6. Current Display shows Output Current and displays Baud rate. Displays total current in Parallel Master/Slave Mode
7. Function/Status LEDs:
 - Alarm
 - Foldback Mode
 - Fine Control
 - Remote Mode
 - Preview Settings
 - Output On
8. Pushbuttons allow flexible user configuration
 - Coarse and Fine adjustment of Output Voltage/Current and Advanced Parallel Master or Slave
 - Preview settings and set Voltage/Current with Output OFF, Front Panel Lock
 - Parallel Master/Slave
 - Set OVP and UVL Limits
 - Set Current Foldback Protection
 - Go to Local Mode and select Address and Baud rate
 - Output ON/OFF and Auto-Re-Start/Safe-Start Mode

Rear Panel Description



1. Remote/Local Output Voltage Sense Connections.
2. DIP Switches select 0-5V or 0-10V Programming and other functions.
3. DB25 (Female) connector allows (Non-isolated) Analog Program and Monitor and other functions.
4. RS-485 OUT to other Genesys™ Power Supplies.
5. RS-232/RS-485 IN Remote Serial Programming.
6. Output Connections: Rugged busbars (shown) for up to 100V Output; wire clamp connector for Outputs >100V.
7. Exit air assures reliable operation when zero stacked.
8. Input: 230VAC Single Phase (shown), 208 & 400VAC Three Phase, 50/60 Hz
AC Input Connector: PHOENIX CONTACT Power Combicon PC 6/... Series with strain relief.
9. Optional Interface Position for IEEE 488.2 SCPI (shown) or Isolated Analog Interface or LAN Interface.

Genesys™ 3.3kW Specifications

1.0 MODEL	GEN	8-400	10-330	15-220	20-165	30-110	40-85	60-55	80-42	100-33	150-22	300-11	600-5.5
1. Rated output voltage(*1)	V	8	10	15	20	30	40	60	80	100	150	300	600
2. Rated Output Current(*2)	A	400	330	220	165	110	85	55	42	33	22	11	5.5
3. Rated Output Power	W	3200	3300	3300	3300	3300	3400	3300	3360	3300	3300	3300	3300

1.1 CONSTANT VOLTAGE MODE

1. Max. line regulation (0.01% of rated Vo+ 2mV)(*6)	mV	2.8	3	3.5	4	5	6	8	10	12	17	32	62	
2. Max. load regulation (0.015% of rated Vo+5mV)(*7)	mV	6.2	6.5	7.25	8	9.5	11	14	17	20	27.5	50	95	
3. Ripple and noise p-p 20MHz(*8)	mV	60	60	60	60	60	60	60	80	80	100	150	500	
4. Ripple r.m.s 5Hz~1MHz	mV	8	8	8	8	8	8	8	8	8	25	35	120	
5. Remote sense compensation/wire	V	2	2	2	2	5	5	5	5	5	5	5	5	
6. Temp. coefficient	PPM/°C	100PPM/°C of rated output voltage, following 30 minutes warm-up												
7. Temp. stability		0.05% of rated Vout over 8hrs interval following 30 minutes warm-up. Constant line, load & temp.												
8. Warm-up drift		Less than 0.05% of rated output voltage+2mV over 30 minutes following power On.												
9. Up-prog. response time, 0~Vo Rated(*9)	mS	80						150						250
10. Down-prog response time	Full-load(*9)	mS	20	100			160			300			500	
	No-load(*10)	mS	500	600	700	800	900	1000	1100	1200	1500	2000	3500	4000
11. Transient response time	mS	Time for output voltage to recover within 0.5% of its rated output for a load change 10-90% of rated output current. Output set-point: 10-100%, local sense. Less than 1mSec for models up to and including 100V. 2msec for models above 100V												

1.2 CONSTANT CURRENT MODE

1. Max. line regulation (0.01% of rated Io+ 2mA)(*6)	mA	42	35	24	18.5	13	10.5	7.5	6.2	5.3	4.2	3.1	2.6
2. Max. load regulation (0.02% of rated Io+5mA)(*11)	mA	85	71	49	38	27	22	16	13.4	11.6	9.4	7.2	6.1
3. Ripple r.m.s 5Hz~1MHz>(*12)	mA	1300	660	440	300	250	200	100	120	90	60	50	10
4. Load regulation thermal drift		Less than 0.1% of rated output current over 30 minutes following load change.											
5. Temp. coefficient	PPM/°C	200PPM/°C from rated output current, following 30 minutes warm-up.											
6. Temp. stability		0.05% of rated Iout over 8hrs. interval following 30minutes warm-up. Constant line, load & temperature.											
7. Warm-up drift		8V~40V models: Less than 0.5% of rated output current over 30 minutes following power On. 60V~600V models: Less than 0.25% of rated output current over 30 minutes following power On.											

1.3 PROTECTIVE FUNCTIONS

1. OCP	0~105% Constant Current
2. OCP Foldback	Output shut down when power supply change from CV to CC. User selectable.
3. OVP type	Inverter shut-down, manual reset by AC input recycle or by OUI button or by communication port command.
4. OVP trip point	0.5~10V 0.5~12V 1~18V 1~24V 2~36V 2~44V 5~66V 5~88V 5~110V 5~165V 5~330V 5~660V
5. Output Under Voltage Limit	Preset by front panel or communication port. Prevents from adjusting Vout below limit.
6. Over Temp. Protection	User selectable, latched or non-latched.

1.4 ANALOG PROGRAMMING AND MONITORING

1. Vout Voltage Programming	0~100%, 0~5V or 0~10V, user select. Accuracy and linearity: ±0.5% of rated Vout.
2. Iout Voltage Programming(*13)	0~100%, 0~5V or 0~10V, user select. Accuracy and linearity: ±1% of rated Iout.
3. Vout Resistor Programming	0~100%, 0~5/10Kohm full scale, user select. Accuracy and linearity: ±1% of rated Vout.
4. Iout Resistor Programming(*13)	0~100%, 0~5/10Kohm full scale, user select. Accuracy and linearity: ±1.5% of rated Iout.
5. On/Off control (rear panel)	By electrical. Voltage: 0~0.6V/2~15V, or dry contact, user selectable logic.
6. Output Current monitor(*13)	0~5V or 0~10V, Accuracy: ±1%, user selectable.
7. Output Voltage monitor	0~5V or 0~10V, Accuracy: ±1%, user selectable.
8. Power Supply OK signal	TTL high (4~5V) -OK, 0V-Fail 500ohm series resistance.
9. CV/CC Indicator	CV: TTL high (4~5V) source: 10mA, CC: TTL low (0~0.6V), sink current: 10mA.
10. Enable/Disable	Dry contact. Open: off, Short: on. Max. voltage at Enable/Disable in: 6V.
11. Local/Remote analog control	By electrical signal or Open/Short: 0~0.6V or short; Remote, 4~5V or open; Local.
12. Local/Remote analog control Indicator	Open collector, Local: Off, Remote: On. Maximum voltage: 30V, maximum sink current: 10mA.

1.5 FRONT PANEL

1. Control functions	Vout/ Iout manual adjust by separate encoders (coarse and fine adjustment selectable).
	OVP/UVL manual adjust by Volt. Adjust encoder.
	On/Off, Output on/off, Re-start modes (auto, safe), Foldback control (CV to CC), Go to local control.
	Address selection by Voltage (or current) adjust encoder. Number of addresses: 31.
	Re-start modes (automatic restart, safe mode).
2. Display	Baud rate selection: 1200, 2400, 4800, 9600 and 19200.
	Voltage: 4 digits, Accuracy: 0.5% of rated output Voltage ±1 count.
	Current: 4 digits, Accuracy: 0.5% of rated output current ±1 count.
3. Indications	Voltage, Current, Alarm, Fine, Preview, Foldback, Local, Output On, Front Panel Lock, CVCC.

1.6 Interface RS-232&RS-485 or Optional GPIB / LAN Interface

Model	V	8	10	15	20	30	40	60	80	100	150	300	600
1. Remote Voltage Programming (16 bit)													
Resolution (0.012% of Vo Rated)	mV	0.96	1.2	1.8	2.40	3.60	4.80	7.2	9.6	12	18	36	72
Accuracy (0.05%Vo Rated+0.05% of Vo Actual Output)	mV	8	10	15	20	30	40	60	80	100	150	300	600
2. Remote Current Programming (16 bit)													
Resolution (0.012% of Io Rated)	mA	48	39.6	26.4	19.8	13.2	10.2	6.6	5.0	4.0	2.6	1.3	0.7
Accuracy (0.2% of Io Rated+0.1% of Io Actual Output)(*13)	mA	1200	990	660	495	330	255	165	126	99	66	33	16.5
3. Readback Voltage													
Resolution (0.012% of Vo Rated)	mV	0.96	1.2	1.8	2.40	3.60	4.80	7.2	9.6	12	18	36	72
Accuracy (0.1%Vo Rated+0.1% of Vo Actual Output)	mV	16	20	30	40	60	80	120	160	200	300	600	1200
4. Readback Current													
Resolution (0.012% of Io Rated)	mA	48	39.6	26.4	19.8	13.2	10.2	6.6	5.0	4.0	2.6	1.3	0.7
Accuracy (0.3% of Io Rated+0.1% of Io Actual Output)(*13)	mA	1600	1320	880	660	440	340	220	168	132	88	44	22
5. OVP/UVL Programming													
Resolution (0.1% of Vo Rated)	mV	8	10	15	20	30	40	60	80	100	150	300	600
Accuracy (1% of Vo Rated)	mV	80	100	150	200	300	400	600	800	1000	1500	3000	6000

*1: Minimum voltage is guaranteed to maximum 0.2% of rated output voltage.

*2: Minimum current is guaranteed to maximum 0.4% of rated output current.

*3: For cases where conformance to various safety standards (UL, IEC, etc) is required, to be described as 190-240Vac (50/60Hz) for single phase and 3-Phase 208V models, and 380~415Vac (50/60Hz) for 3-Phase 400V models.

*4: Single-Phase and 3-Phase 208V models: At 208Vac input voltage, 3-Phase 400V: At 380Vac input voltage. With rated output power.

*5: Not including EMI filter inrush current, less than 0.2mSec.

*6: Single-Phase and 3-Phase 208V models: 170~265Vac, constant load. 3-Phase 400V models: 342~460Vac, constant load.

*7: From No-Load to Full-Load, constant input voltage. Maximum drop in Remote Sense.

*8: For 8V~300V models: Measured with JEITA RC-9131A (1:1) probe. For 600V model: Measured with 10:1 probe.

*9: From 10% to 90% or 90% to 10% of Rated Output Voltage, with rated, resistive load.

*10: From 90% to 10% of Rated Output Voltage.

*11: For load voltage change, equal to the unit voltage rating, constant input voltage.

*12: For 8V~15V models the ripple is measured from 2V to rated output voltage and rated output current. For other models, the ripple is measured at 10~100% of rated output voltage and rated output current.

*13: The Constant Current programming readback and monitoring accuracy does not include the warm-up and Load regulation thermal drift.

General Specifications Genesys™ 3.3kW

2.1 INPUT CHARACTERISTICS		GEN	8-400	10-330	15-220	20-165	30-110	40-85	60-55	80-42	100-33	150-22	300-11	600-5.5
1. Input voltage/freq. (*3)		VAC	Single Phase,230V models: 170~265Vac, 47~63Hz 3-Phase, 208V models: 170~265Vac, 47~63Hz 3-Phase, 400V models: 342~460Vac, 47~63Hz											
2. Maximum Input current at 100% load	Single Phase,230V models:	A	24	24	24	24	24	24	23	23	23	23	23	23
	3-Phase, 208V models:	A	15	15	15	15	15	15	14.5	14.5	14.5	14.5	14.5	14.5
	3-Phase, 400V models:	A	7.5	7.5	7.5	7.5	7.5	7.5	7	7	7	7	7	7
3. Power Factor (Typ)			Single Phase models: 0.99@230Vac, rated output power. 3-Phase models: 0.94@208/380Vac, rated output power.											
4. Efficiency (*4)		%	82	84	84	86	86	88	88	88	88	88	88	87
5. Inrush Current (*5)		A	Single-Phase and 3-Phase 208V models: Less than 50A 3-Phase 400V models: Less than 20A											
6. Hold-up time (Typ)		mS	10mSec for Single-Phase and 3-phase 208V models, 6mSec for 3-Phase 400V models. Rated output power.											

2.2 POWER SUPPLY CONFIGURATION

1. Parallel Operation	Up to 4 identical units in master/slave mode
2. Series Operation	Up to 2 identical units. with external diodes. 600V Max to Chassis ground

2.3 ENVIRONMENTAL CONDITIONS

1. Operating temp	0~50°C, 100% load.
2. Storage temp	-30~85°C
3. Operating humidity	20~90% RH (non-condensing).
4. Storage humidity	10~95% RH (non-condensing).
5. Vibration	MIL-810F, method 514.5, The EUT is fixed to the vibrating surface.
6. Shock	Less than 20G, half sine, 11mSec. Unit is unpacked.
7. Altitude	Operating: 10000ft (3000m), Derate output current by 2%/100m above 2000m, Alternatively, derate maximum ambient temp. by 1°C/100m above 2000m. Non operating: 40000ft (12000m).
8. RoHS Compliance	Complies with the requirements of RoHS directive.

2.4 EMC

1. Applicable Standards:	
2. ESD	IEC1000-4-2. Air-disch.-8KV, contact disch.-4KV
3. Fast transients	IEC1000-4-4. 2KV
4. Surge immunity	IEC1000-4-5. 1KV line to line, 2KV line to ground
5. Conducted immunity	IEC1000-4-6, 3V
6. Radiated immunity	IEC1000-4-3, 3V/m
7. Magnetic field immunity	EN61000-4-8, 1A/m
8. Voltage dips	EN61000-4-11
9. Conducted emission	EN55022A, FCC part 15-A, VCCI-A.
10. Radiated emission	EN55022A, FCC part 15-A, VCCI-A.

2.5 SAFETY

1. Applicable standards:	CE Mark, UL60950, EN60950 listed. Vout≤40V: Output is SELV, IEEE/Isolated analog are SELV. 40<Vout≤400V: Output is hazardous, IEEE/Isolated analog are SELV. 400<Vout≤600V: Output is hazardous, IEEE/Isolated analog are not SELV.
2. Withstand voltage	Vout≤40V models :Input-Outputs (SELV): 4242VDC 1min, Input-Ground: 2828VDC 1min. 40<Vout≤100V models: Input-Haz. Output: 2600VDC 1min, Input-SELV: 4242VDC 1min. Hazardous Output.-SELV: 1900VDC 1min, Hazardous Output-Ground:1200VDC 1min. Input-Ground: 2828VDC 1min. 100<Vout≤600V models: Input-Haz. Output: 4000VDC 1min, Input-SELV: 4242VDC 1min. Hazardous Output.-SELV: 3550VDC 1min. Hazardous Output-Ground:2670VDC 1min. Input-Ground: 2828VDC 1min.
3. Insulation resistance	More than 100Mohm at 25°C, 70% RH.

2.6 MECHANICAL CONSTRUCTION

1. Cooling	Forced air flow: from front to rear. No ventilation holes at the top or bottom of the chassis; Variable fan speed.
2. Dimensions (WxHxD)	W: 423mm, H: 88mm, D: 442.5mm (excluding connectors, encoders, handles, etc.)
3. Weight	13 kg.
4. AC Input connector (with Protective Cover)	Single Phase,230V models, Power Combicon PC 6-16/3-GF-10,16 series, with Strain relief. 3-Phase, 208V & 400V models, Power Combicon PC 6-16/4-GF-10,16 series, with Strain relief.
5. Output connectors	8V to 100V models: Bus-bars (hole Ø 10.5mm). 150V to 600V models: wire clamp connector, Phoenix P/N: FRONT-4-H-7.62

2.7 RELIABILITY SPECS

1. Warranty	5 years.
-------------	----------

All specifications subject to change without notice.

Outline Drawing Genesys™ 3.3kW Units

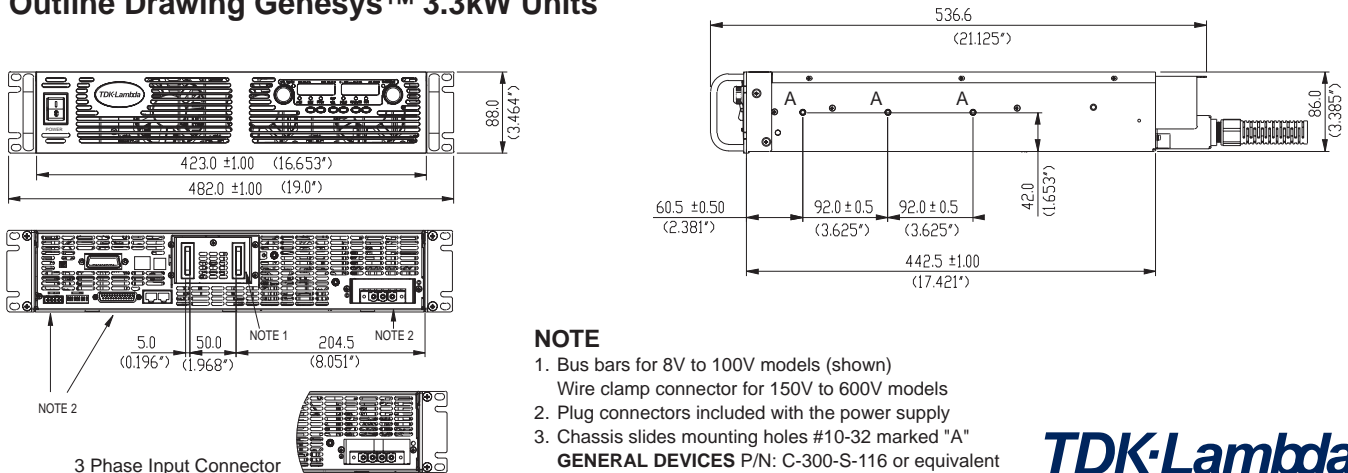

Genesys™ Power Parallel and Series Configurations

Parallel operation - Master/Slave:

Active current sharing allows up to four identical units to be connected in an auto-parallel configuration for four times the output power.

In Advanced Parallel Master/Slave Mode, total current is programmed and reported by the Master, Up to four supplies act as one.



Series operation

Up to two units may be connected in series to increase the output voltage or to provide bipolar output. (Max 600V to Chassis Ground).

Remote Programming via RS-232 & RS-485 Interface

Standard Serial Interface allows daisy-chain control of up to 31 power supplies on the same communication bus with built-in RS-232 & RS-485 Interface.

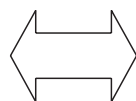

Programming Options (Factory installed)

Digital Programming via IEEE Interface

P/N: IEEE

- IEEE 488.2 SCPI Compliant
- Program Voltage
- Measure Voltage
- Over Voltage setting and shutdown
- Error and Status Messages
- **New! Multi-Drop**
 - Allows IEEE Master to control up to 31 slaves over RS-485 daisy-chain
 - Only the Master needs be equipped with IEEE Interface
- Program Current
- Measure Current
- Current Foldback shutdown

Isolated Analog Programming

Four Channels to Program and Monitor Voltage and Current.

Isolation allows operation with floating references in harsh electrical environments.

Choose between programming with Voltage or Current.

Connection via removable terminal block: Phoenix MC1,5/8-ST-3.81.

- Voltage Programming, user-selectable 0-5V or 0-10V signal.
Power supply Voltage and Current Programming Accuracy $\pm 1\%$
Power supply Voltage and Current Monitoring Accuracy $\pm 1.5\%$
- Current Programming with 4-20mA signal.
Power supply Voltage and Current Programming Accuracy $\pm 1\%$
Power supply Voltage and Current Monitoring Accuracy $\pm 1.5\%$

P/N: IS510

P/N: IS420

LAN Interface

LXI™ Compliant to Class C

P/N: LAN

- Meets all LXI-C Requirements
- Address Viewable on Front Panel
- Fixed and Dynamic Addressing
- Compatible with most standard Networks
- VISA & SCPI Compatible
- LAN Fault Indicators
- Auto-detects LAN Cross-over Cable
- Fast Startup

Power Supply Identification / Accessories

How to order

GEN	8	-	400	-		
Series Name	Output Voltage (0~8V)	Output Current (0~400A)	Factory Options: Option: IEEE IS510 IS420 LAN	Factory AC Input Options: 1P230 (Single Phase 170~265VAC) 3P208 (Three Phase 170~265VAC) 3P400 (Three Phase 342~460VAC)		

Models 3.3kW

Model	Output Voltage VDC	Output Current (A)	Output Power (W)
GEN 8-400	0~8V	0~400	3200
GEN 10-330	0~10V	0~330	3300
GEN 15-220	0~15V	0~220	3300
GEN 20-165	0~20V	0~165	3300
GEN 30-110	0~30V	0~110	3300
GEN 40-85	0~40V	0~85	3400

Model	Output Voltage VDC	Output Current (A)	Output Power (W)
GEN 60-55	0~60V	0~55	3300
GEN 80-42	0~80V	0~42	3360
GEN 100-33	0~100V	0~33	3300
GEN 150-22	0~150V	0~22	3300
GEN 300-11	0~300V	0~11	3300
GEN 600-5.5	0~600V	0~5.5	3300

Factory option

RS-232/RS-485 Interface built-in Standard	P/N
GPIB Interface	-
Voltage Programming Isolated Analog Interface	IEEE
Current Programming Isolated Analog Interface	IS510
LAN Interface (Complies with LXI™ Class C)	IS420
	LAN

Accessories

1. Serial Communication cable

RS-232/RS-485 cable is used to connect the power supply to the Host PC.

Mode	RS-485	RS-232	RS-232
PC Connector	DB-9F	DB-9F	DB-25F
Communication Cable	Shield Ground L=2m	Shield Ground L=2m	Shield Ground L=2m
Power Supply Connector	EIA/TIA-568A (RJ-45)	EIA/TIA-568A (RJ-45)	EIA/TIA-568A (RJ-45)
P/N	GEN/485-9	GEN/232-9	GEN/232-25

2. Serial link cable*

Daisy-chain up to 31 Genesys™ power supplies.

Mode	Power Supply Connector	Communication Cable	P/N
RS-485	EIA/TIA-568A (RJ-45)	Shield Ground L=50cm	GEN/RJ45

* Included with power supply

**Also available, Genesys™
1U full Rack 750W/1500W
& Half Rack 750W**



Genesis™

**Programmable DC Power Supplies
5KW in 2U
Built in RS-232 & RS-485 Interface
Advanced Parallel Standard**

**Optional Interfaces:
LXI Compliant LAN
IEEE488.2 SCPI (GPIB)
Isolated Analog Programming**



TDK-Lambda

The Genesys™ family of programmable power supplies sets a new standard for flexible, reliable, AC/DC power systems in OEM, Industrial and Laboratory applications.

Features include:

- High Power Density 5kW in 2U
- Wide Range of popular worldwide AC inputs, 3ø (208VAC, 400VAC)
- Active Power Factor Correction (Three-Phase AC Input)
- Output Voltage up to 600V, Current up to 600A
- Built-in RS-232/RS-485 Interface Standard
- Global Commands for Serial RS-232/RS-485 Interface
- Auto-Re-Start / Safe-Start: user selectable
- Last-Setting Memory
- High Resolution 16 bit ADCs & DACs
- Low Ripple & Noise
- Front Panel Lock selectable from Front Panel or Software
- Reliable Encoders for Voltage and Current Adjustment
- Constant Voltage/Constant Current auto-crossover
- Parallel Operation with Active Current Sharing; up to four identical units.
- Advanced Parallel Master / Slave. Total Current is Programmed and Measured via the Master.
- Independent Remote ON/OFF and Remote Enable/Disable
- External Analog Programming and Monitoring (user selectable 0-5V & 0-10V)
- Reliable Modular and SMT Design
- 19" Rack Mount capability for ATE and OEM applications
- Optional Interfaces
 - Isolated Analog Programming and Monitoring Interface (0-5V/0-10V & 4-20mA)
 - IEEE 488.2 SCPI (GPIB) Multi-Drop
 - LXI** Compliant LAN
- LabView® and LabWindows® drivers
- Five Year Warranty

Worldwide Safety Agency Approvals; CE Mark for LVD and EMC Regulation



Applications

Genesys™ power supplies have been designed to meet the demands of a wide variety of applications. System Designers will appreciate new, standard, remote programming features such as Global commands. Also, new high-speed status monitoring is available for the RS-485 bus.

Test Systems using the IEEE-488 bus may achieve significant cost savings by incorporating the Optional IEEE Multi-Drop Interface for a Master and up to 30 RS-485 Multi-Drop Slaves.

Higher power systems can be configured with up to four 5kW modules. Each module is 2U with zero space between them (zero stack).

Flexible configuration is provided by the complete Genesys™ Family: 1U 750W Half-Rack, 1U 750W/1500W 2U 3.3kW/5kW Full-Rack. All are identical in Front Panel, Rear Panel Analog, and all Digital Interface Commands.

OEM Designers have a wide variety of Inputs and Outputs from which to select depending on application and location.

Front Panel Description

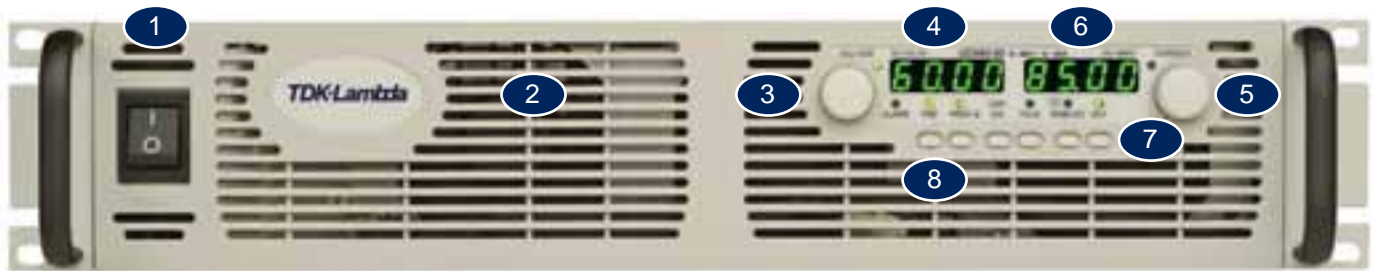

1. ON/OFF Switch
2. Air Intake allows zero stacking for maximum system flexibility and power density.
3. Reliable encoder controls Output Voltage, Address, OVP and UVL settings.
4. Volt Display shows Output Voltage and directly displays OVP, UVL and Address settings.
5. Reliable encoder controls Output Current, sets baudrate and Advanced Parallel mode.
6. Current Display shows Output Current and displays Baud rate. Displays total current in Parallel Master/Slave Mode
7. Function/Status LEDs:
 - Alarm
 - Foldback Mode
 - Fine Control
 - Remote Mode
 - Preview Settings
 - Output On
8. Pushbuttons allow flexible user configuration
 - Coarse and Fine adjustment of Output Voltage/Current and Advanced Parallel Master or Slave
 - Preview settings and set Voltage/Current with Output OFF, Front Panel Lock
 - Parallel Master/Slave
 - Set OVP and UVL Limits
 - Set Current Foldback Protection
 - Go to Local Mode and select Address and Baud rate
 - Output ON/OFF and Auto-Re-Start/Safe-Start Mode

Rear Panel Description



1. Remote/Local Output Voltage Sense Connections.
2. DIP Switches select 0-5V or 0-10V Programming and other functions.
3. DB25 (Female) connector allows (Non-isolated) Analog Program and Monitor and other functions.
4. RS-485 OUT to other Genesys™ Power Supplies.
5. RS-232/RS-485 IN Remote Serial Programming.
6. Output Connections: Rugged busbars (shown) for up to 100V Output; wire clamp connector for Outputs >100V.
7. Exit air assures reliable operation when zero stacked.
8. Input: 208 & 400VAC Three Phase, 50/60 Hz
AC Input Connector: PHOENIX CONTACT Power Combicon PC 6/... Series with strain relief.
9. Optional Interface Position for IEEE 488.2 SCPI (shown) or Isolated Analog Interface or LAN Interface.

Genesys™ 5kW Specifications

1.0 MODEL	GEN	8-600	10-500	16-310	20-250	30-170	40-125	60-85	80-65	100-50	150-34	300-17	600-8.5
1. Rated output voltage(*1)	V	8	10	16	20	30	40	60	80	100	150	300	600
2. Rated Output Current(*2)	A	600	500	310	250	170	125	85	65	50	34	17	8.5
3. Rated Output Power	W	4800	5000	4960	5000	5100	5000	5100	5200	5000	5100	5100	5100
4. Development Priority	---	A	C	B	C	B	B	A	C	C	A	B	A

1.1 CONSTANT VOLTAGE MODE

1. Max. line regulation (0.01% of rated Vo)(*6)	mV	0.8	1.0	1.6	2	3	4	6	8	10	15	30	60	
2. Max. load regulation (0.015% of rated Vo+5mV)(*7)	mV	6.2	6.5	7.4	8	9.5	11	14	17	20	27.5	50	95	
3. Ripple and noise p-p 20MHz (*8)	mV	75	75	75	75	75	75	75	85	100	120	300	500	
4. Ripple r.m.s 5Hz~1MHz	mV	10	10	10	10	10	10	10	12	15	25	35	120	
5. Remote sense compensation/wire	V	2	2	2	2	5	5	5	5	5	5	5	5	
6. Temp. coefficient	PPM/°C	100PPM/°C of rated output voltage, following 30 minutes warm-up												
7. Temp. stability		0.05% of rated Vout over 8hrs interval following 30 minutes warm-up. Constant line, load & temp.												
8. Warm-up drift		Less than 0.05% of rated output voltage+2mV over 30 minutes following power On.												
9. Up-prog. response time, 0~Vo Rated (*9)	mS	30mS						50mS						100
10. Down-prog response time	Full-load (*9)	mS	15	50	80	100	1200	1500	2000	2500	3000			
	No-load (*10)	mS	400	500	600	700	800	900	1000	1200	1500	2000	2500	3000
11. Transient response time	mS	Time for output voltage to recover within 0.5% of its rated output for a load change 10-90% of rated output current. Output set-point: 10-100%, local sense. Less than 1mSec for models up to and including 100V. 2msec for models above 100V												

1.2 CONSTANT CURRENT MODE

1. Max. line regulation (0.05% of Io rated)(*6)	mA	300	250	155	125	85	62.5	42.5	32.5	25	17	8.5	4.25
2. Max. load regulation (0.1% of Io rated)(*11)	mA	600	500	310	250	170	125	85	65	50	34	17	8.5
3. Ripple r.m.s 5Hz~1MHz. (*12)	mA	1950	1800	1400	1000	460	300	150	120	100	90	30	15
4. Temp. coefficient	PPM/°C	100PPM/°C from rated output current, following 30 minutes warm-up.											
5. Temp. stability		0.05% of rated Iout over 8hrs. interval following 30minutes warm-up. Constant line, load & temperature.											
6. Warm-up drift		8V~16V models: Less than ±0.5% of rated output current over 30 minutes following power On. 20V~600V models: Less than ±0.25% of rated output current over 30 minutes following power On.											

1.3 PROTECTIVE FUNCTIONS

1. OCP	0~105% Constant Current
2. OCP Foldback	Output shut down when power supply change from CV to CC. User selectable.
3. OVP type	Inverter shut-down, manual reset by AC input recycle or by OUI button or by communication port command.
4. OVP trip point	0.5~10V 0.5~12V 1~19V 1~24V 2~36V 2~44.1V 5~66.15V 5~88.2V 5~110.25V 5~165.3V 5~330.7V 5~661.5V
5. Output Under Voltage Limit	Preset by front panel or communication port. Prevents from adjusting Vout below limit.
6. Over Temp. Protection	User selectable, latched or non-latched.

1.4 ANALOG PROGRAMMING AND MONITORING

1. Vout Voltage Programming	0~100%, 0~5V or 0~10V, user select. Accuracy and linearity: ±0.5% of rated Vout.
2. Iout Voltage Programming (*13)	0~100%, 0~5V or 0~10V, user select. Accuracy and linearity: ±1% of rated Iout.
3. Vout Resistor Programming	0~100%, 0~5/10Kohm full scale, user select. Accuracy and linearity: ±1% of rated Vout.
4. Iout Resistor Programming (*13)	0~100%, 0~5/10Kohm full scale, user select. Accuracy and linearity: ±1.5% of rated Iout.
5. On/Off control (rear panel)	By electrical. Voltage: 0~0.6V/2~15V, or dry contact, user selectable logic.
6. Output Current monitor (*13)	0~5V or 0~10V, Accuracy: ±1%, user selectable.
7. Output Voltage monitor	0~5V or 0~10V, Accuracy: ±1%, user selectable.
8. Power Supply OK signal	TTL high (4~5V) -OK, 0V-Fail 500ohm series resistance.
9. CV/CC Indicator	Open collector, CC mode: On, CV mode: Off, Maximum voltage: 30V, maximum sink current: 10mA
10. Enable/Disable	Dry contact. Open: off, Short: on. Max. voltage at Enable/Disable in: 6V.
11. Local/Remote analog control	By electrical signal or Open/Short: 0~0.6V or short; Remote, 2~15V or open: Local.
12. Local/Remote analog control Indicator	Open collector, Local: Off, Remote: On. Maximum voltage: 30V, maximum sink current: 10mA.

1.5 FRONT PANEL

1. Control functions	Vout/ Iout manual adjust by separate encoders (coarse and fine adjustment selectable).
	OVP/UVL manual adjust by Volt. Adjust encoder.
	On/Off, Output on/off, Re-start modes (auto, safe), Foldback control (CV to CC), Go to local control.
	Address selection by Voltage (or current) adjust encoder. Number of addresses: 31.
	Re-start modes (automatic restart, safe mode).
	Baud rate selection: 1200, 2400, 4800, 9600 and 19200.
2. Display	Voltage: 4 digits, Accuracy: 0.5% of rated output Voltage ±1 count.
	Current: 4 digits, Accuracy: 0.5% of rated output current ±1 count.
3. Indications	Voltage, Current, Alarm, Fine, Preview, Foldback, Local, Output On, Front Panel Lock, CV/CC.

1.6 Interface RS-232&RS-485 or Optional GPIB / LAN Interface

Model	V	8	10	16	20	30	40	60	80	100	150	300	600
1. Remote Voltage Programming (16 bit)													
Resolution (0.012% of Vo Rated)	mV	0.96	1.2	1.92	2.4	3.6	4.8	7.2	9.6	12	18	36	72
Accuracy (0.1% of Vo Rated)	mV	8	10	15	20	30	40	60	80	100	150	300	600
2. Remote Current Programming (16 bit)													
Resolution (0.012% of Io Rated)	mA	72	60	37.2	30	20.4	15	10.2	7.8	6.0	4.08	2.04	1.02
Accuracy (0.3% of Io Rated+0.1% of Io Actual Output)(*13)	mA	2400	2000	1240	1000	680	500	340	260	200	136	68	34
3. Readback Voltage													
Resolution (0.012% of Vo Rated)	mV	0.96	1.2	1.92	2.40	3.60	4.80	7.2	9.6	12	18	36	72
Accuracy (0.15% of Vo Rated)	mV	12	15	24	30	45	60	90	120	150	225	450	900
4. Readback Current													
Resolution (0.012% of Io Rated)	mA	72	60	37.2	30	20.4	15	10.2	7.8	6.0	4.08	2.04	1.02
Accuracy (0.4% of Io Rated)(*13)	mA	2400	2000	1240	1000	680	500	340	260	200	136	68	34
5. OVP/UVL Programming													
Resolution (0.1% of Vo Rated)	mV	8	10	16	20	30	40	60	80	100	150	300	600
Accuracy (1% of Vo Rated)	mV	80	100	160	200	300	400	600	800	1000	1500	3000	6000

*1: Minimum voltage is guaranteed to maximum 0.2% of rated output voltage.

*2: Minimum current is guaranteed to maximum 0.4% of rated output current.

*3: For cases where conformance to various safety standards (UL, IEC, etc) is required, to be described as 190-240Vac (50/60Hz) for 3-Phase 208V models, and 380~415Vac (50/60Hz) for 3-Phase 400V models.

*4: 3-Phase 208V models: At 208Vac input voltage, 3-Phase 400V: At 380Vac input voltage. With rated output power.

*5: Not including EMI filter inrush current, less than 0.2mSec.

*6: 3-Phase 208V models: 170~265Vac, constant load. 3-Phase 400V models: 342~460Vac, constant load.

*7: From No-Load to Full-Load, constant input voltage. Maximum drop in Remote Sense.

*8: For 8V~300V models: Measured with JEITA RC-9131A (1:1) probe. For 600V model: Measured with 10:1 probe.

*9: From 10% to 90% or 90% to 10% of Rated Output Voltage, with rated, resistive load.

*10: From 90% to 10% of Rated Output Voltage.

*11: For load voltage change, equal to the unit voltage rating, constant input voltage.

*12: For 8V~16V models the ripple is measured from 2V to rated output voltage and rated output current. For other models, the ripple is measured at 10~100% of rated output voltage and rated output current.

*13: The Constant Current programming readback and monitoring accuracy does not include the warm-up and Load regulation thermal drift.

General Specifications Genesys™ 5kW

2.1 INPUT CHARACTERISTICS		GEN	8-600	10-500	16-310	20-250	30-170	40-125	60-85	80-65	100-50	150-34	300-17	600-8.5
1. Input voltage/freq. (*3)		VAC	3-Phase 200Vac , 208Vac and 230Vac Models : 170-265Vrms , 47-63Hz 3-Phase, 400V models: 342-460Vac, 47-63Hz											
2. Maximum Input current at 100% load	3-Phase, 170V models:	(A)	21	22	22	22	22	22	22	22	22	22	22	22
	3-Phase, 342V models:	(A)	10.5	11	11	11	11	11	11	11	11	11	11	11
3. Power Factor (Typ)			0.94 AT 100% LOAD AND 208V/380V/400V/415V											
4. INRUSH PEAK CURRENT		A	3-Phase 200V: 50A, 3-Phase 400V: 20A. Not including the EMI filter inrush current, less than 0.2mSec.											
5. EFFICIENCY AT 200V AND 380V (A)		%	83	84	84	86	86	88	90	88	88	88	88	88
6. EFFICIENCY AT 170V AND 342V (A)		%	83	84	84	86	86	88	90	88	88	88	88	88
7. HOLD UP TIME (CV MODE)		mS	5mS Typical											
8. PHASE IMBALANCE		%	≤5%											
9. LEAKAGE CURRENT			LESS THAN 3mA											

2.2 POWER SUPPLY CONFIGURATION

1. Parallel Operation	Up to 4 identical units in master/slave mode
2. Series Operation	Up to 2 identical units. with external diodes. 600V Max to Chassis ground

2.3 ENVIRONMENTAL CONDITIONS

1. Operating temp	0-50°C, 100% load.
2. Storage temp	-20-85°C
3. Operating humidity	20-90% RH (non-condensing).
4. Storage humidity	10-95% RH (non-condensing).
5. Vibration	MIL-810F, method 514.5 , The EUT is fixed to the vibrating surface.
6. Shock	Less than 20G , half sine , 11mSec. Unit is unpacked.
7. Altitude	Operating: 10000ft (3000m), Derate output current by 2%/100m above 2000m, Non operating: 40000ft (12000m).
8. RoHS Compliance	Complies with the requirements of RoHS directive.

2.4 EMC

1. Applicable Standards:	
2. ESD	IEC1000-4-2. Air-disch.-8KV, contact disch.-4KV
3. Fast transients	IEC1000-4-4, 2KV
4. Surge immunity	IEC1000-4-5. 1KV line to line, 2KV line to ground
5. Conducted immunity	IEC1000-4-6, 3V
6. Radiated immunity	IEC1000-4-3, 3V/m
7. Magnetic field immunity	EN61000-4-8, 1A/m
8. Voltage dips	EN61000-4-11
9. Conducted emission	EN55022A, FCC part 15-A, VCCI-A.
10. Radiated emission	EN55022A, FCC part 15-A, VCCI-A.

2.5 SAFETY

1. Applicable standards:	CE Mark, UL60950, EN60950 listed. Vout≤40V: Output is SELV , IEEEE/Isolated analog are SELV. 40<Vout≤400V: Output is hazardous, IEEEE/Isolated analog are SELV. 400<Vout≤600V: Output is hazardous, IEEEE/Isolated analog are not SELV.
2. Withstand voltage	Vout≤40V models : Input-Outputs (SELV): 4242VDC 1min, Input-Ground: 2828VDC 1min. 40<Vout≤100V models: Input-Haz. Output: 2600VDC 1min, Input-SELV: 4242VDC 1min. Hazardous Output.-SELV: 1900VDC 1min, Hazardous Output-Ground: 1200VDC 1min. Input-Ground: 2828VDC 1min. 100<Vout≤600V models: Input-Haz. Output: 4000VDC 1min, Input-SELV: 4242VDC 1min. Hazardous Output.-SELV: 3550VDC 1min. Hazardous Output-Ground: 2670VDC 1min. Input-Ground: 2828VDC 1min.
3. Insulation resistance	More than 100Mohm at 25°C , 70% RH.

2.6 MECHANICAL CONSTRUCTION

1. Cooling	Forced air flow: from front to rear. No ventilation holes at the top or bottom of the chassis; Variable fan speed.
2. Dimensions (WxHxD)	W: 423mm, H: 88mm, D: 442.5mm (excluding connectors, encoders, handles, etc.)
3. Weight	16 kg.
4. AC Input connector (with Protective Cover)	3-Phase, 208V & 400V models, Power Combicon PC 6-16/4-GF-10,16 series, with Strain relief.
5. Output connectors	8V to 100V models: Bus-bars (hole Ø 10.5mm). 150V to 600V models: wire clamp connector, Phoenix P/N: FRONT-4-H-7.62

2.7 RELIABILITY SPECS

1. Warranty	5 years.
-------------	----------

All specifications subject to change without notice.

Outline Drawing Genesys™ 5kW Units

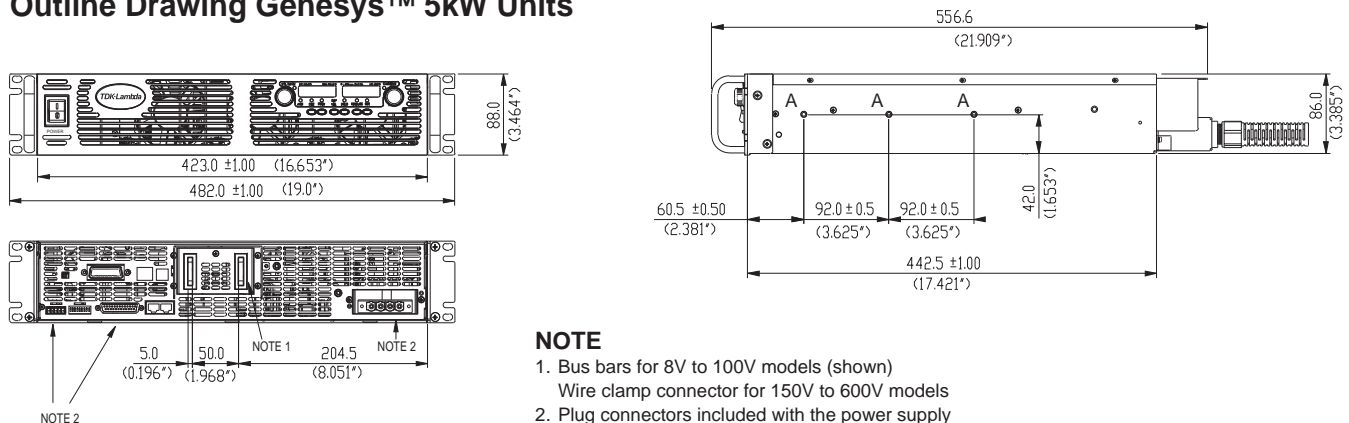

NOTE

- Bus bars for 8V to 100V models (shown)
Wire clamp connector for 150V to 600V models
- Plug connectors included with the power supply
- Chassis slides mounting holes #10-32 marked "A"
GENERAL DEVICES P/N: C-300-S-116 or equivalent

Genesys™ Power Parallel and Series Configurations

Parallel operation - Master/Slave:

Active current sharing allows up to four identical units to be connected in an auto-parallel configuration for four times the output power.

In Advanced Parallel Master/Slave Mode, total current is programmed and reported by the Master, Up to four supplies act as one.



Series operation

Up to two units may be connected in series to increase the output voltage or to provide bipolar output. (Max 600V to Chassis Ground).

Remote Programming via RS-232 & RS-485 Interface

Standard Serial Interface allows daisy-chain control of up to 31 power supplies on the same communication bus with built-in RS-232 & RS-485 Interface.

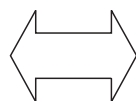

Programming Options (Factory installed)

Digital Programming via IEEE Interface

P/N: IEEE

- IEEE 488.2 SCPI Compliant
- Program Voltage
- Measure Voltage
- Over Voltage setting and shutdown
- Error and Status Messages
- **New! Multi-Drop**
 - Allows IEEE Master to control up to 31 slaves over RS-485 daisy-chain
 - Only the Master needs be equipped with IEEE Interface
- Program Current
- Measure Current
- Current Foldback shutdown

Isolated Analog Programming

Four Channels to Program and Monitor Voltage and Current. Isolation allows operation with floating references in harsh electrical environments. Choose between programming with Voltage or Current. Connection via removable terminal block: Phoenix MC1,5/8-ST-3.81.

- Voltage Programming, user-selectable 0-5V or 0-10V signal.
 - Power supply Voltage and Current Programming Accuracy $\pm 1\%$
 - Power supply Voltage and Current Monitoring Accuracy $\pm 1.5\%$
- Current Programming with 4-20mA signal.
 - Power supply Voltage and Current Programming Accuracy $\pm 1\%$
 - Power supply Voltage and Current Monitoring Accuracy $\pm 1.5\%$

P/N: IS510

P/N: IS420

LAN Interface

LXI Compliant to Class C

P/N: LAN

- Meets all LXI-C Requirements
- Address Viewable on Front Panel
- Fixed and Dynamic Addressing
- Compatible with most standard Networks
- VISA & SCPI Compatible
- LAN Fault Indicators
- Auto-detects LAN Cross-over Cable
- Fast Startup

Power Supply Identification / Accessories

How to order

GEN	8	-	600	-	
Series Name	Output Voltage (0~8V)	Output Current (0~600A)	Factory Options: Option: IEEE IS510 IS420 LAN	Factory AC Input Options: 3P208 (Three Phase 170~265VAC) 3P400 (Three Phase 342~460VAC)	

Models 5kW

Model	Output Voltage VDC	Output Current (A)	Output Power (W)
GEN 8-600	0~8V	0~600	4800
GEN 10-500	0~10V	0~500	5000
GEN 16-310	0~16V	0~310	4960
GEN 20-250	0~20V	0~250	5000
GEN 30-170	0~30V	0~170	5100
GEN 40-125	0~40V	0~125	5000

Model	Output Voltage VDC	Output Current (A)	Output Power (W)
GEN 60-85	0~60V	0~85	5100
GEN 80-65	0~80V	0~65	5200
GEN 100-50	0~100V	0~50	5000
GEN 150-34	0~150V	0~34	5100
GEN 300-17	0~300V	0~17	5100
GEN 600-8.5	0~600V	0~8.5	5100

Factory option

RS-232/RS-485 Interface built-in Standard	P/N
GPIB Interface	-
Voltage Programming Isolated Analog Interface	IEEE
Current Programming Isolated Analog Interface	IS510
LAN Interface (Complies with LXI Class C)	IS420
	LAN

Accessories

1. Serial Communication cable

RS-232/RS-485 cable is used to connect the power supply to the Host PC.

Mode	RS-485	RS-232	RS-232
PC Connector	DB-9F	DB-9F	DB-25F
Communication Cable	Shield Ground L=2m	Shield Ground L=2m	Shield Ground L=2m
Power Supply Connector	EIA/TIA-568A (RJ-45)	EIA/TIA-568A (RJ-45)	EIA/TIA-568A (RJ-45)
P/N	GEN/485-9	GEN/232-9	GEN/232-25

2. Serial link cable*

Daisy-chain up to 31 Genesys™ power supplies.

Mode	Power Supply Connector	Communication Cable	P/N
RS-485	EIA/TIA-568A (RJ-45)	Shield Ground L=50cm	GEN/RJ45

* Included with power supply

Also available, Genesys™
1U Half Rack 750W
1U full Rack 750W/1500W
2U full Rack 3300W

