

General Description

This document describes the C-VM2020 Coupon PCB evaluation board. The coupon PCB provides a quick and simple way of evaluating the differential analog output VM2020 microphone. The board consists of a VM2020 bottom port MEMS microphone and a 0.1uF power supply bypass capacitor along with an edge connector. The user can simply use a corresponding female connector (CW Industries CWR-170-10-0000) or solder wires to make good electrical contact to the power and output pins of the microphone.

Pinout and Pin Descriptions

The board is shown in Figure 1 as follows and the corresponding pins in table 1 have been labeled:

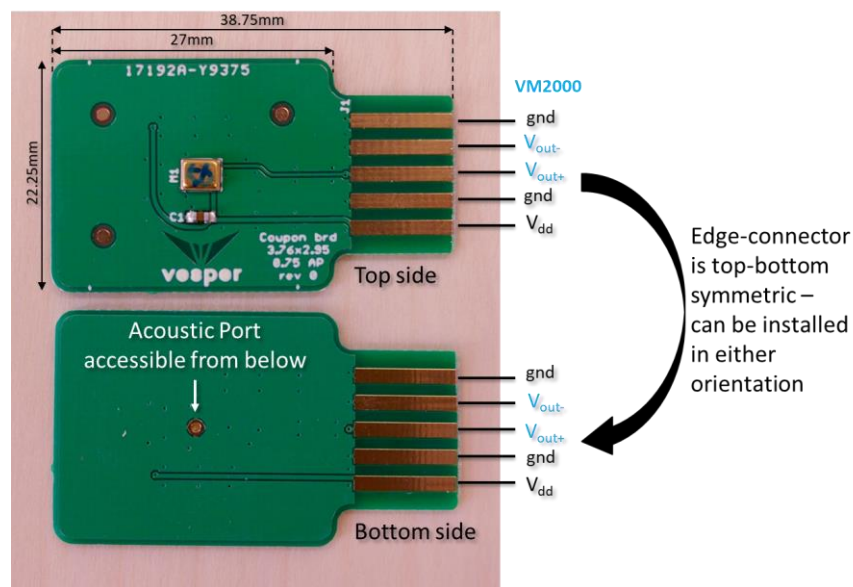

Figure 1. VM2020 Coupon PCB (Edge Connector recommendation is provided below)

Board Pin #	Name	Description
1	Gnd	Ground
2	Vout -	Analog Output -
3	Vout +	Analog Output +
4	Gnd	Ground
5	Vdd	Power Supply 2.25V to 3.6V DC

Table 1: Pin Configuration

Edge Connector

VM2020 Coupon PCB can be used with an Edge connector from CW Industries with part number CWR-170-10-0000. Supply range for Vdd is 2.25V – 3.6V

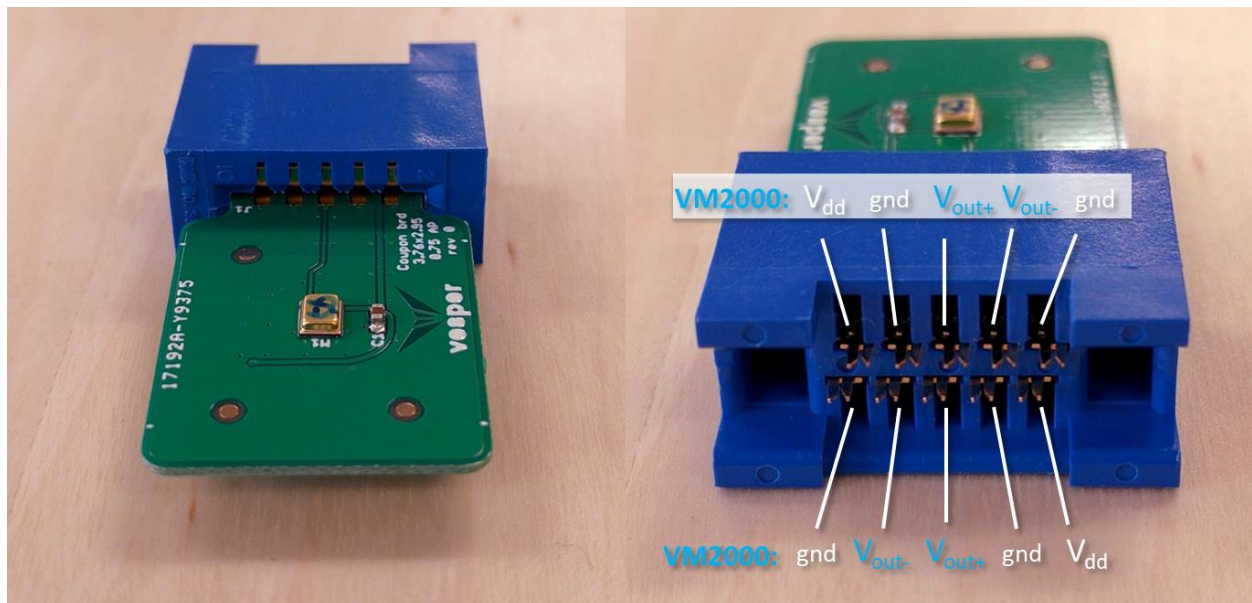

Figure 2: Connections on VM2020 Coupon PCB and Edge Connector CWR-170-10-0000

Schematic

The schematic of the board is shown in Figure 2. The S-VM200-C Coupon pcb consists of the VM200 microphone and the 0.1uF power supply bypass capacitor.

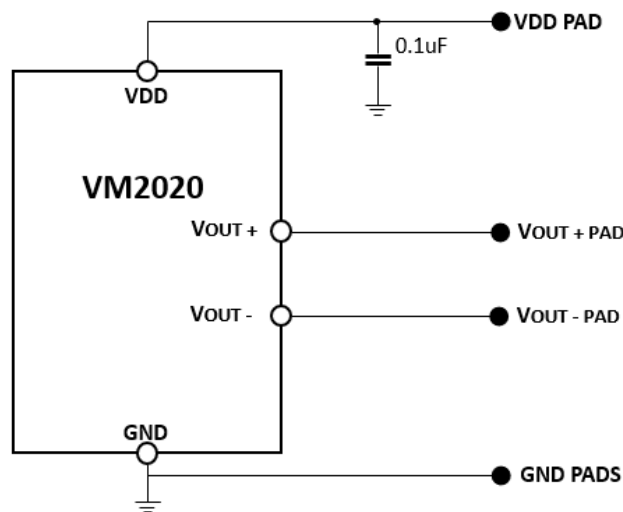
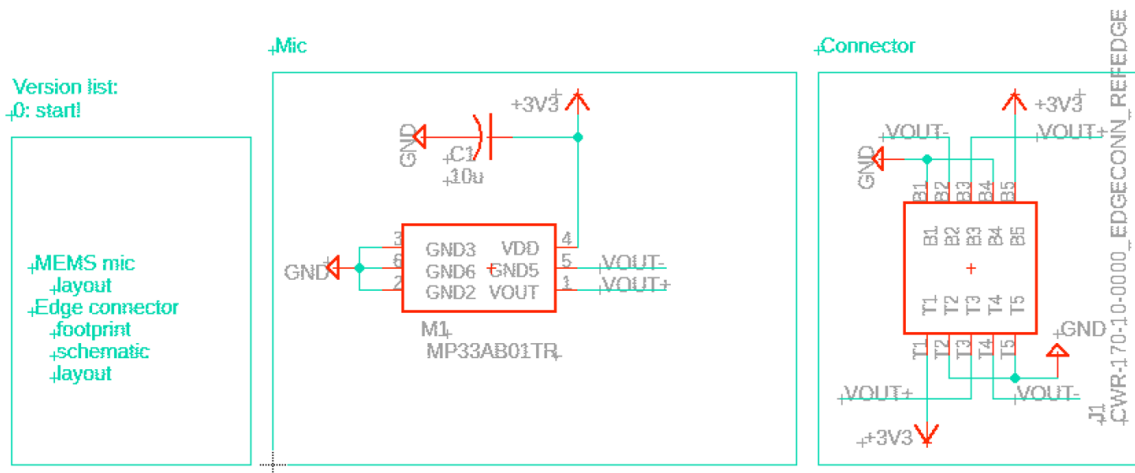
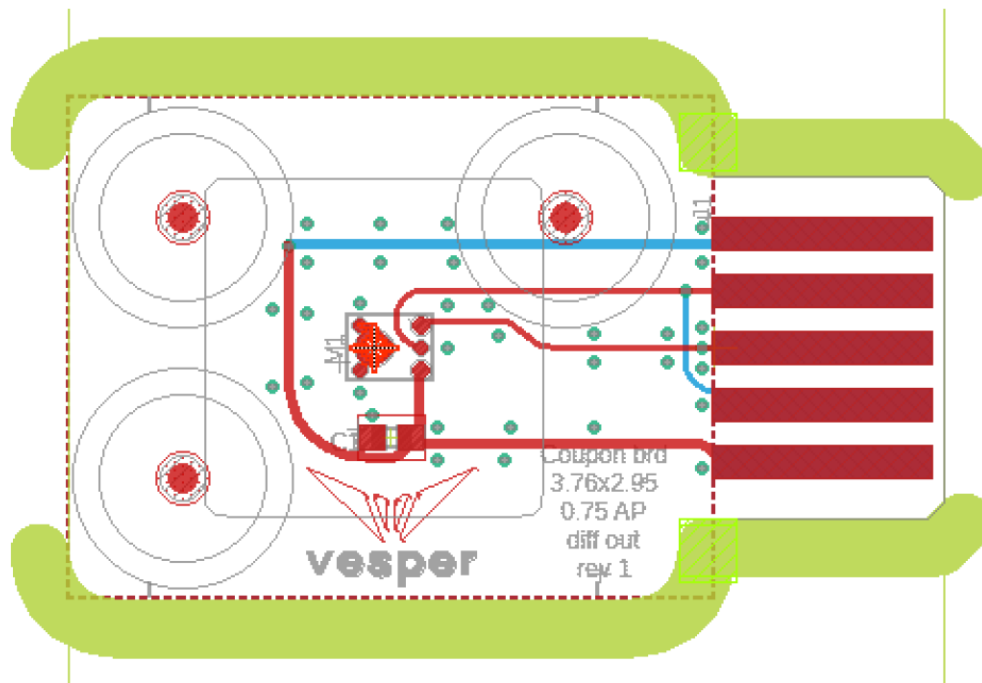

Figure 3: S-VM200-C Coupon PCB Schematic



Fab on Smart Prototyping 0.8mm process
ENIG plating
2-layer

Figure 4: S-VM2020-C Coupon PCB board layout

Other Information

The detailed specifications and description of the VM2020 microphone can be found in the product datasheet. For convenience the basic parameters and absolute maximum ratings also shown in Table 2 and Table 3 below:

Parameter	Typical Value	Units
Supply Voltage	2.6	V
I _{dd}	248	μA
Sensitivity @ 94dB SPL	-63.0	dBV
	0.71	mV _{rms}
Output Impedance, V _{out+} , V _{out-}	1400	Ω
Output DC Offset, V _{out+} , V _{out-}	0.8	V

Table 2. Typical parameters for microphone operation

Parameter	Rating	Units
Supply Voltage	-0.3 to +3.6	V
Sound Pressure Level	180	dB re 20 μPa
Operating Temperature Range	-40 to +85	°C
Storage Temperature Range	-55 to +150	°C
Mechanical Shock	10,000g per IEC 60028-2-27:2008	
Vibration	Per MIL-STD 883E, 2007.2	

Table 3. Absolute Maximum Ratings

For additional information on Vesper products, contact info@vespermems.com.