

MOSFET

Metal Oxide Semiconductor Field Effect Transistor

CFDA Automotive

650V CoolMOS™ CFDA Power Transistor
IPW65R048CFDA

Data Sheet

Rev. 2.0
Final

Automotive

1 Description

CoolMOS™ is a revolutionary technology for high voltage power MOSFETs, designed according to the superjunction (SJ) principle and pioneered by Infineon Technologies. 650V CoolMOS™ CFDA series combines the experience of the leading SJ MOSFET supplier with high class innovation. The resulting devices provide all benefits of a fast switching SJ MOSFET while offering an extremely fast and robust body diode. This combination of extremely low switching, commutation and conduction losses together with highest robustness make especially resonant switching applications more reliable, more efficient, lighter, and cooler.

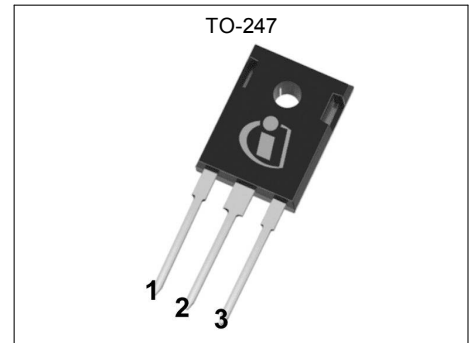

Features

- Ultra-fast body diode
- Very high commutation ruggedness
- Extremely low losses due to very low FOM $R_{ds(on)} \cdot Q_g$ and E_{oss}
- Easy to use/drive
- Qualified according to AEC Q101
- Green package (RoHS compliant), Pb-free plating, halogen free for mold compound

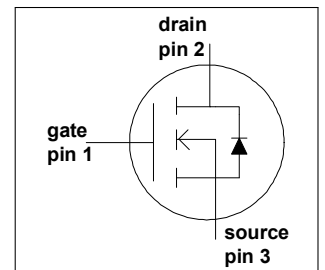

Applications

650V CoolMOS™ CFDA is designed for switching applications.



Table 1 Key Performance Parameters

Parameter	Value	Unit
V_{DS}	650	V
$R_{DS(on),max}$	0.048	Ω
Q_g,typ	270	nC
$I_D,pulse$	228	A
$E_{oss @ 400V}$	20.5	μJ
Body diode di/dt	900	A/ μs
Q_{rr}	1.8	μC
t_{rr}	240	ns
I_{rrm}	12	A

Type / Ordering Code	Package	Marking	Related Links
IPW65R048CFDA	PG-TO 247	65F6048A	-



Table of Contents

Description	2
Table of Contents	3
Maximum ratings	4
Thermal characteristics	5
Electrical characteristics	6
Electrical characteristics diagrams	8
Test Circuits	12
Package Outlines	13
Revision History	14
Disclaimer	14

2 Maximum ratings

at $T_j = 25^\circ\text{C}$, unless otherwise specified

Table 2 Maximum ratings

Parameter	Symbol	Values			Unit	Note / Test Condition
		Min.	Typ.	Max.		
Continuous drain current ¹⁾	I_D			63.3	A	$T_C = 25^\circ\text{C}$
				40		$T_C = 100^\circ\text{C}$
Pulsed drain current ²⁾	$I_{D,pulse}$			228	A	$T_C = 25^\circ\text{C}$
Avalanche energy, single pulse	E_{AS}			1943	mJ	$I_D = 12.7\text{A}$, $V_{DD} = 50\text{V}$ (see table 18)
Avalanche energy, repetitive	E_{AR}			2.94	mJ	$I_D = 12.7\text{A}$, $V_{DD} = 50\text{V}$
Avalanche current, repetitive	I_{AR}			12.7	A	
MOSFET dv/dt ruggedness	dv/dt			50	V/ns	$V_{DS} = 0 \dots 400\text{V}$
Gate source voltage	V_{GS}	-20		20	V	static
		-30		30		AC ($f > 1\text{ Hz}$)
Power dissipation (non FullPAK) TO-247	P_{Tot}			500	W	$T_C = 25^\circ\text{C}$
Operating and storage temperature	T_j, T_{stg}	-40		150	$^\circ\text{C}$	
Mounting torque (non FullPAK) TO-247				60	Ncm	M3 and M3.5 screws
Continuous diode forward current	I_S			63.3	A	$T_C = 25^\circ\text{C}$
Diode pulse current	$I_{S,pulse}$			228	A	$T_C = 25^\circ\text{C}$
Reverse diode dv/dt ³⁾	dv/dt			50	V/ns	$V_{DS} = 0 \dots 400\text{V}$, $I_{SD} \leq I_D$, $T_j = 25^\circ\text{C}$ (see table 16)
Maximum diode commutation speed	di_f/dt			900	A/ μs	

¹⁾ Limited by $T_{j\text{ max}}$.

²⁾ Pulse width t_p limited by $T_{j\text{ max}}$

³⁾ Identical low side and high side switch with identical R_G

3 Thermal characteristics

Table 3 Thermal characteristics TO-247

Parameter	Symbol	Values			Unit	Note / Test Condition
		Min.	Typ.	Max.		
Thermal resistance, junction - case	R_{thJC}			0.25	K/W	
Thermal resistance, junction - ambient	R_{thJA}			62	K/W	leaded
Soldering temperature, wavesoldering only allowed at leads	T_{sold}			260	°C	1.6 mm (0.063 in.) from case for 10s

4 Electrical characteristics

at $T_j = 25^\circ\text{C}$, unless otherwise specified

Table 4 Static characteristics

Parameter	Symbol	Values			Unit	Note / Test Condition
		Min.	Typ.	Max.		
Drain-source breakdown voltage ¹⁾	$V_{(BR)DSS}$	650			V	$V_{GS} = 0V, I_D = 1mA$
Gate threshold voltage	$V_{GS(th)}$	3.5	4	4.5	V	$V_{DS} = V_{GS}, I_D = 2.9mA$
Zero gate voltage drain current	I_{DSS}			3	μA	$V_{DS} = 650V, V_{GS} = 0V, T_j = 25^\circ C$
			900			$V_{DS} = 650V, V_{GS} = 0V, T_j = 150^\circ C$
Gate-source leakage current	I_{GSS}			100	nA	$V_{GS} = 20V, V_{DS} = 0V$
Drain-source on-state resistance	$R_{DS(on)}$		0.043	0.048	Ω	$V_{GS} = 10V, I_D = 29.4A, T_j = 25^\circ C$
			0.112			$V_{GS} = 10V, I_D = 29.4A, T_j = 150^\circ C$
Gate resistance	R_G		0.6		Ω	$f = 1MHz, \text{open drain}$

Table 5 Dynamic characteristics

Parameter	Symbol	Values			Unit	Note / Test Condition
		Min.	Typ.	Max.		
Input capacitance	C_{iss}		7440		pF	$V_{GS} = 0V, V_{DS} = 100V, f = 1MHz$
Output capacitance	C_{oss}		350		pF	
Effective output capacitance, energy related ²⁾	$C_{o(er)}$		250		pF	$V_{GS} = 0V, V_{DS} = 0 \dots 400V$
Effective output capacitance, time related ³⁾	$C_{o(tr)}$		1260		pF	$I_D = \text{constant}, V_{GS} = 0V, V_{DS} = 0 \dots 400V$
Turn-on delay time	$t_{d(on)}$		22		ns	$V_{DD} = 480V, V_{GS} = 13V, I_D = 44.2A, R_G = 1.8\Omega$ (see table 17)
Rise time	t_r		10		ns	
Turn-off delay time	$t_{d(off)}$		85		ns	
Fall time	t_f		4		ns	

Table 6 Gate charge characteristics

Parameter	Symbol	Values			Unit	Note / Test Condition
		Min.	Typ.	Max.		
Gate to source charge	Q_{gs}		48		nC	$V_{DD} = 480V, I_D = 44.2A, V_{GS} = 0 \text{ to } 10V$
Gate to drain charge	Q_{gd}		147		nC	
Gate charge total	Q_g		270		nC	
Gate plateau voltage	$V_{plateau}$		6.4		V	

¹⁾ For applications with applied blocking voltage > 65% of the specified blocking voltage, we recommend to evaluate the impact of the cosmic radiation effect in early design phase. For assessment please contact local Infineon sales office.

²⁾ $C_{o(er)}$ is a fixed capacitance that gives the same stored energy as C_{oss} while V_{DS} is rising from 0 to 400V

³⁾ $C_{o(tr)}$ is a fixed capacitance that gives the same charging time as C_{oss} while V_{DS} is rising from 0 to 400V

Table 7 Reverse diode characteristics

Parameter	Symbol	Values			Unit	Note / Test Condition
		Min.	Typ.	Max.		
Diode forward voltage	V_{SD}		0.9		V	$V_{GS} = 0V, I_F = 44.2A, T_j = 25^\circ C$
Reverse recovery time	t_{rr}		240		ns	$V_R = 400V, I_F = 44.2A,$ $di_F/dt = 100A/\mu s$ (see table 16)
Reverse recovery charge	Q_{rr}		1.8		μC	
Peak reverse recovery current	I_{rrm}		12		A	

5 Electrical characteristics diagrams

Table 8

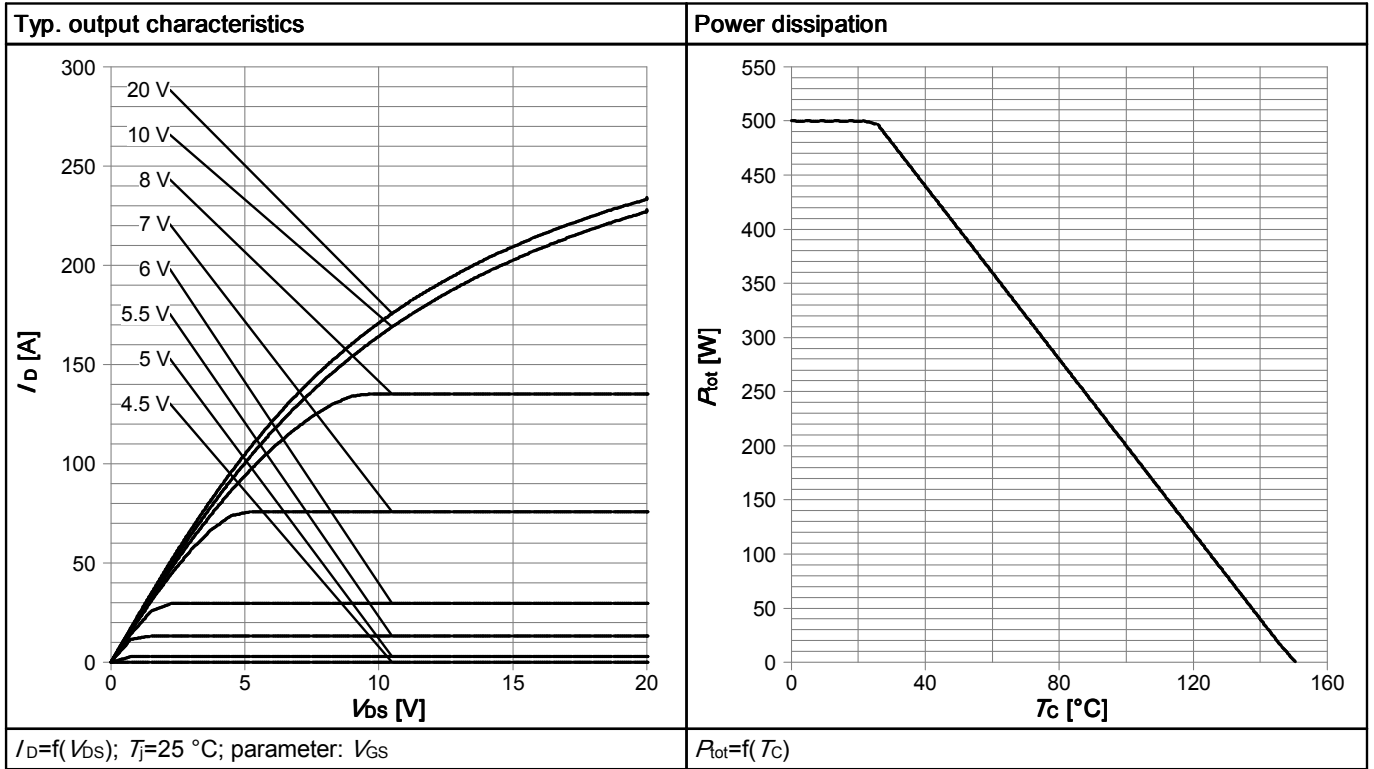

Table 9

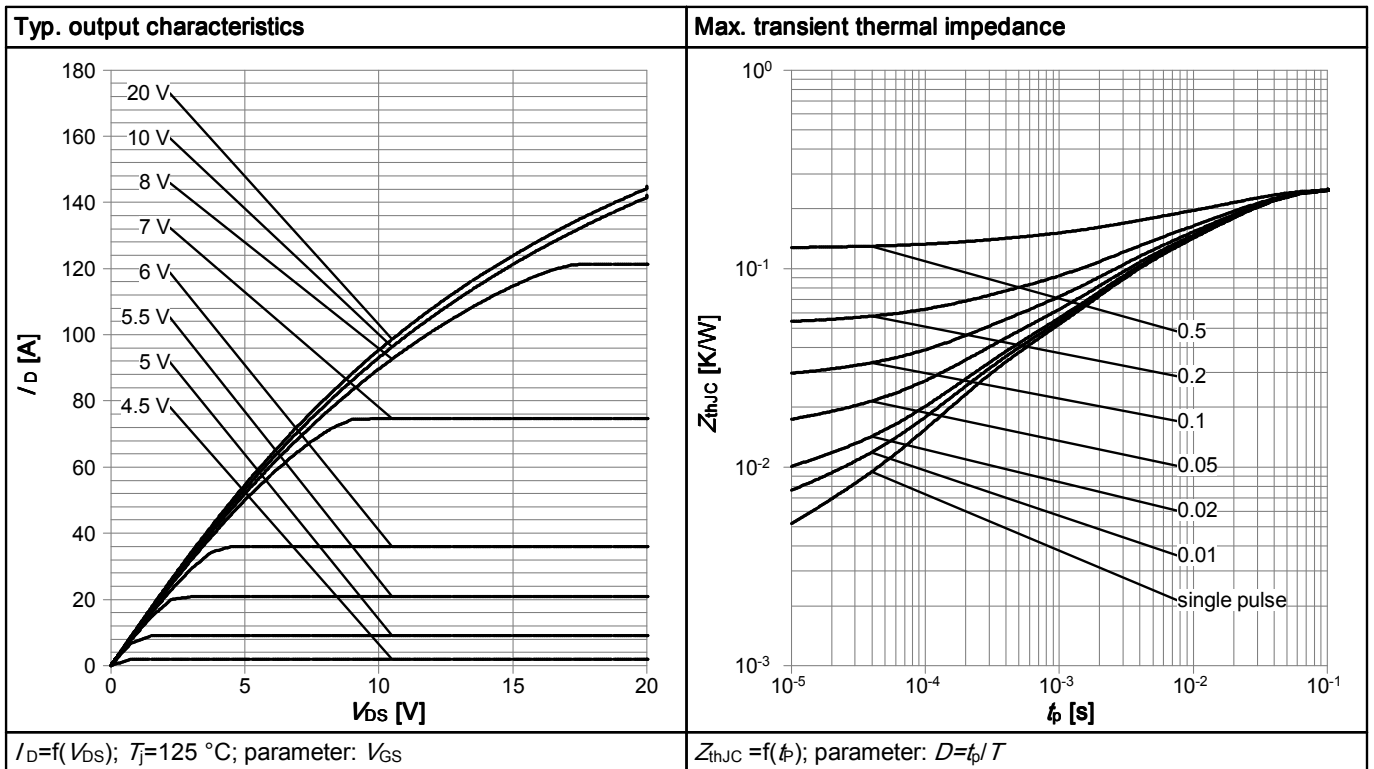

Table 10

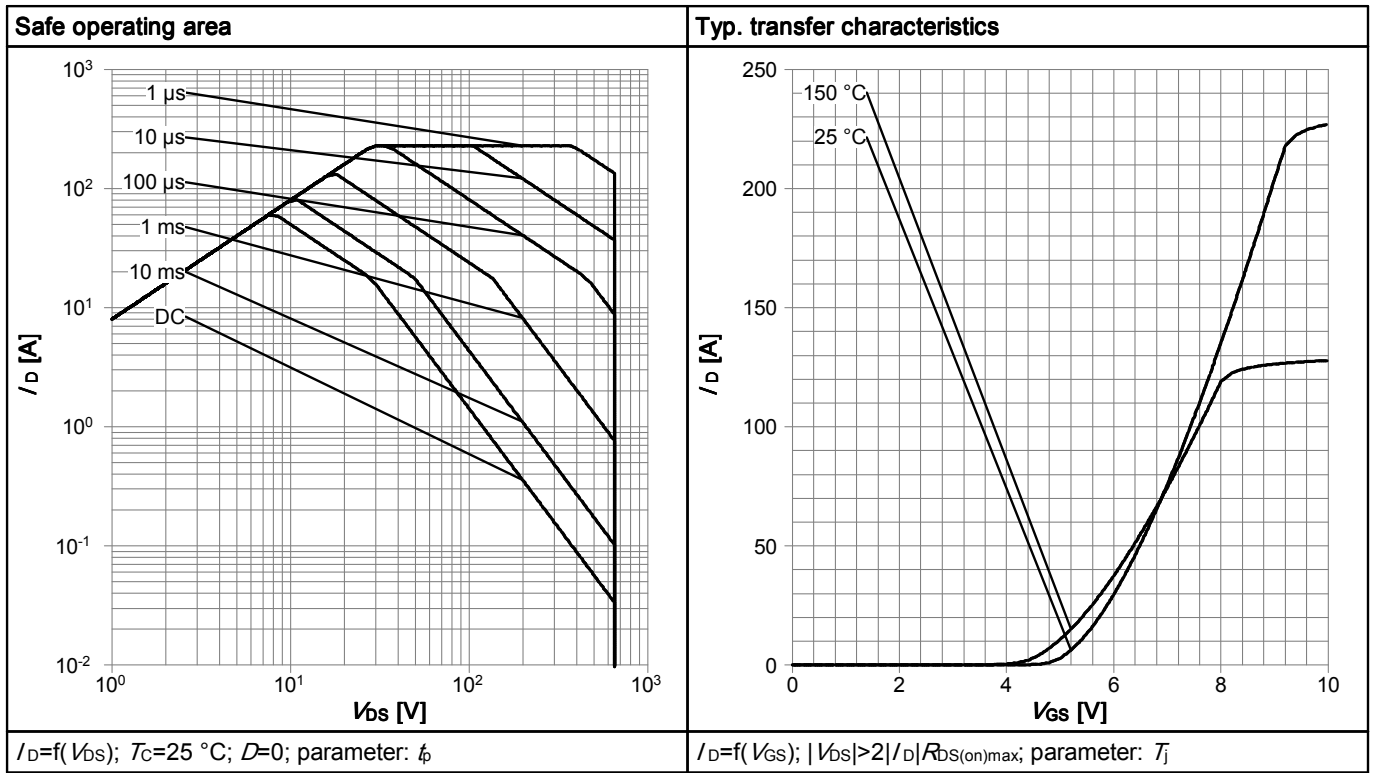

Table 11

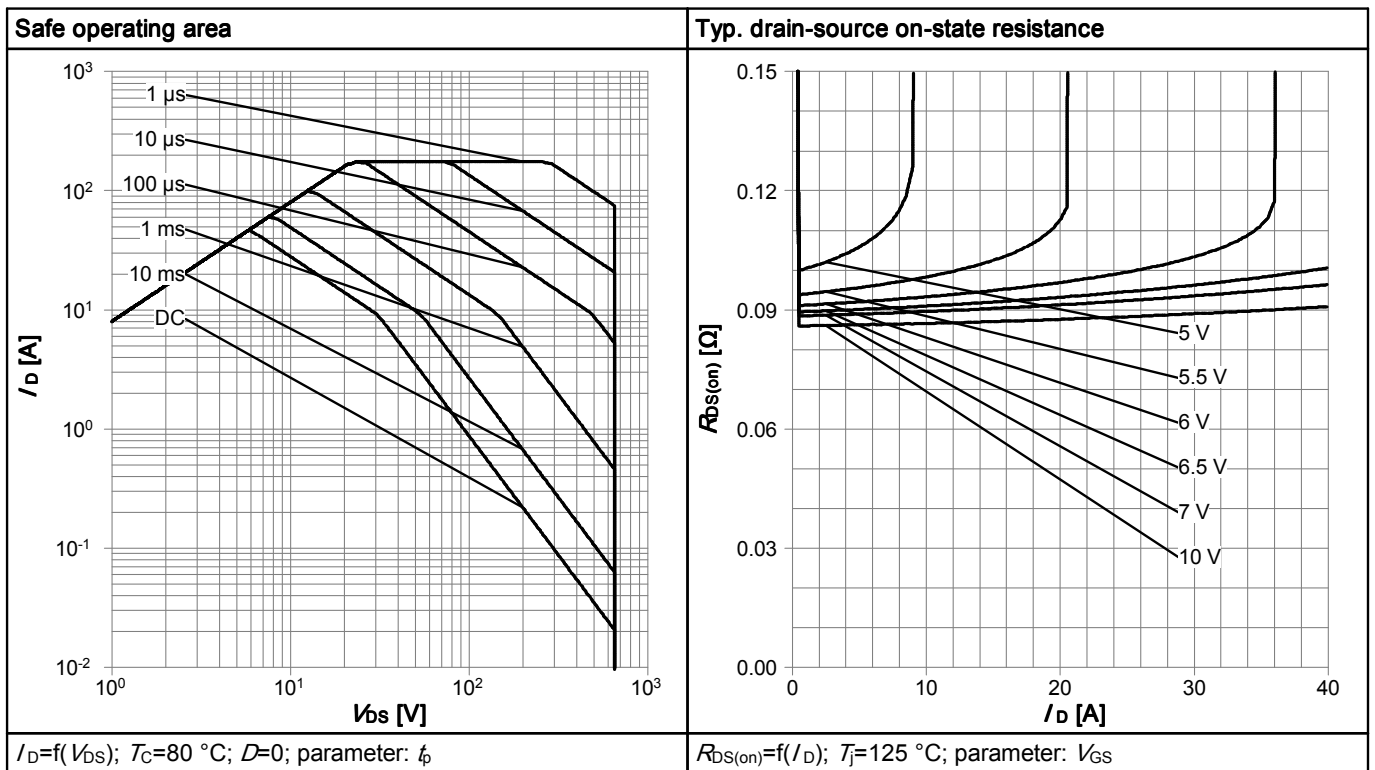

Table 12

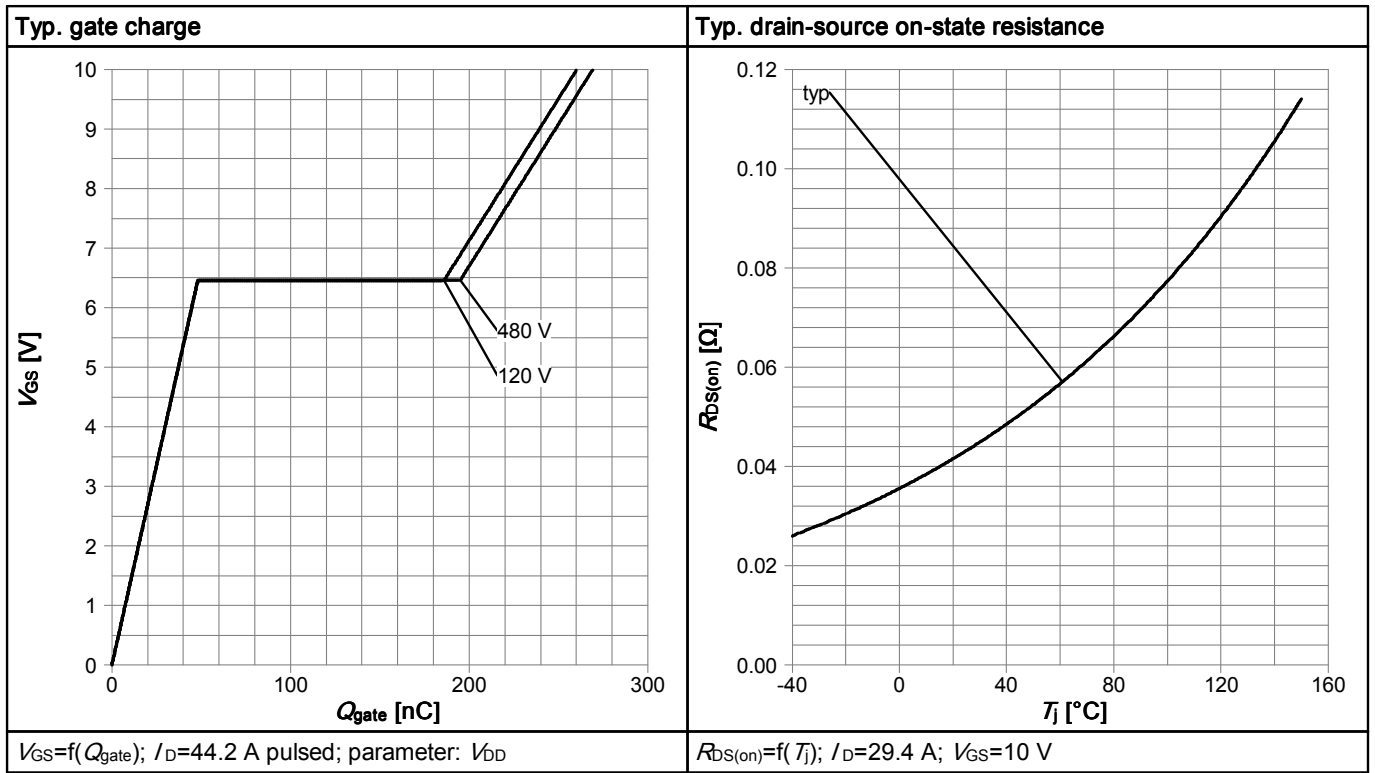

Table 13

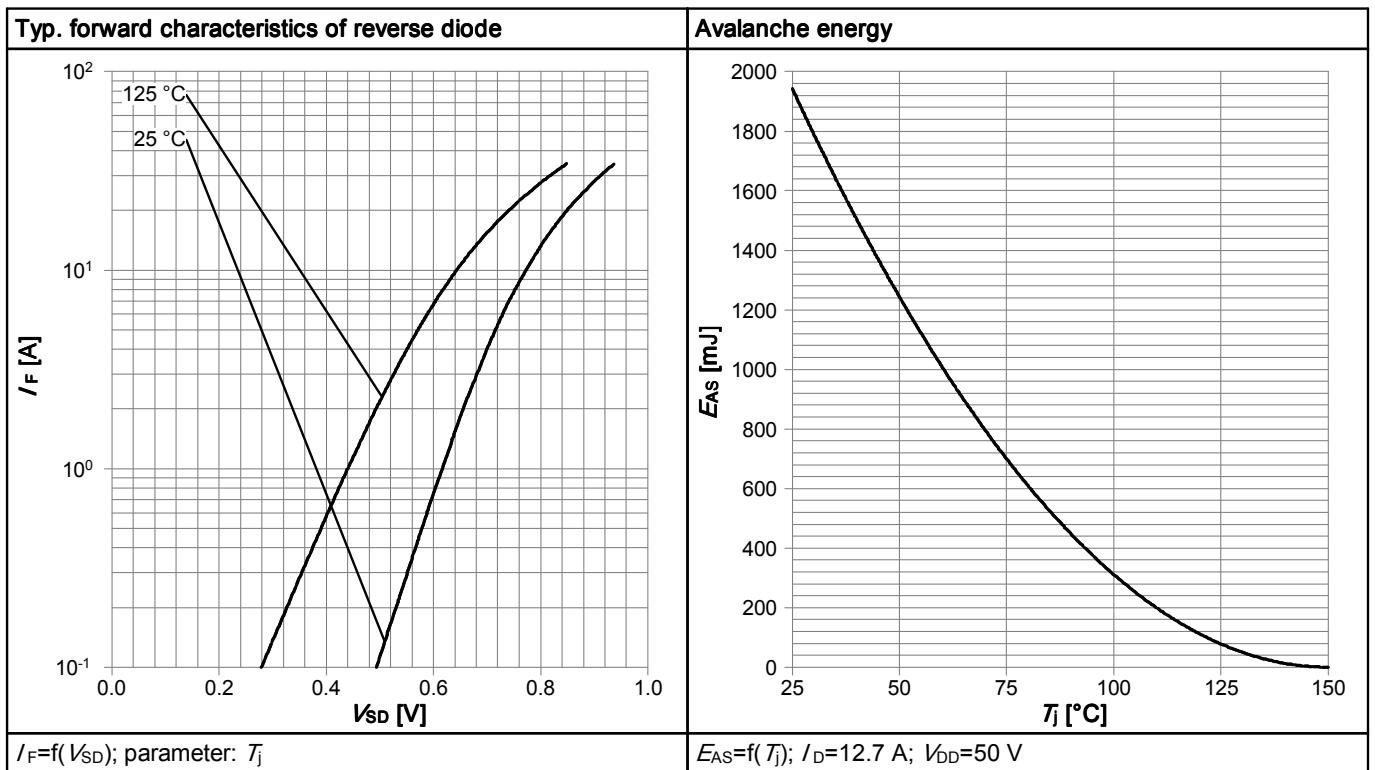

Table 14

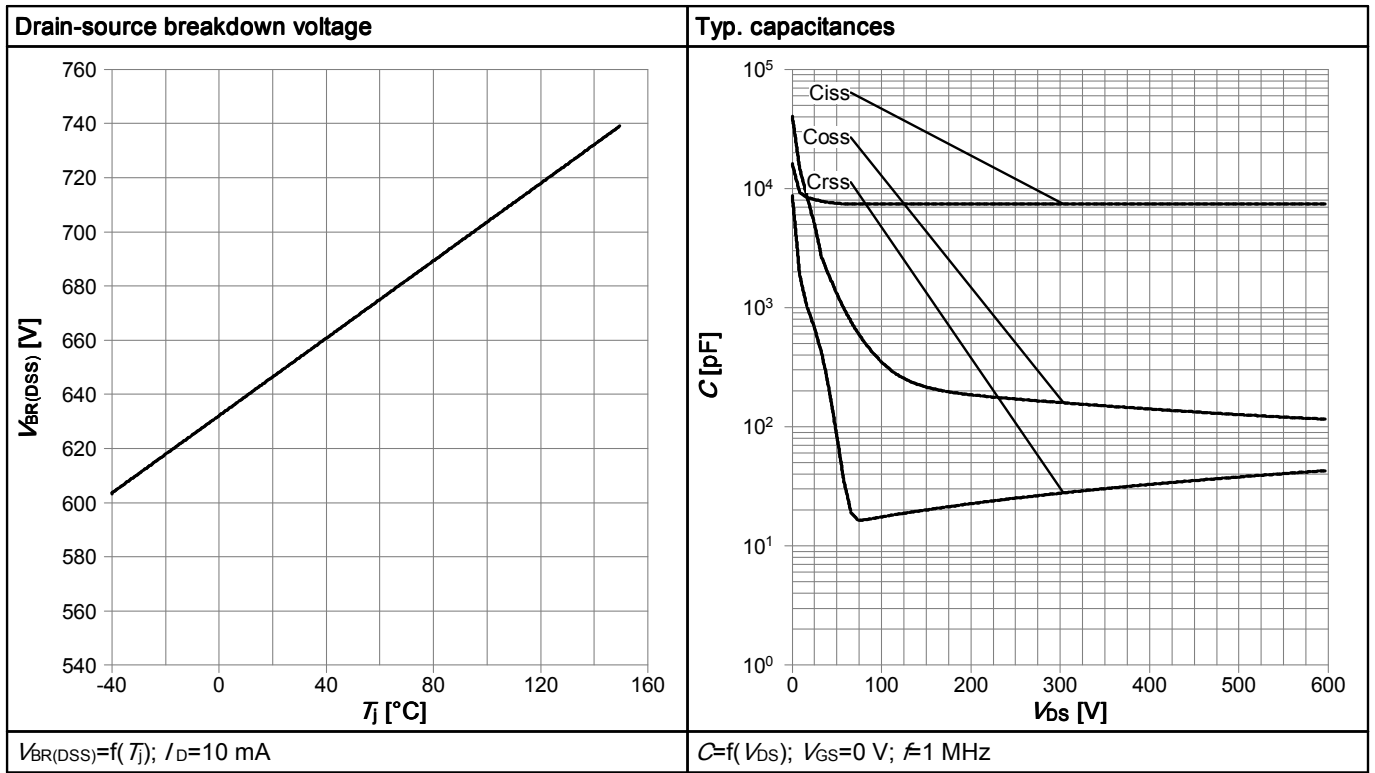
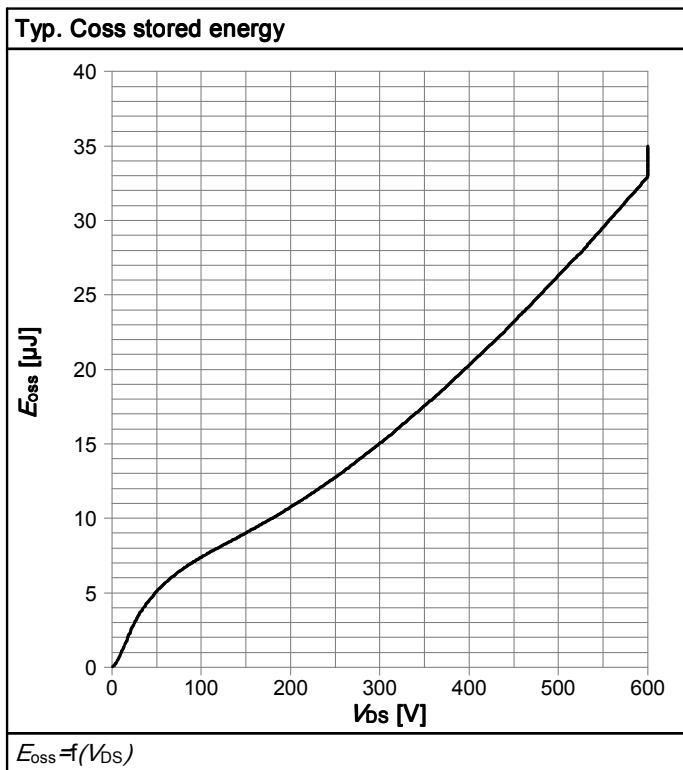

Table 15



6 Test Circuits

Table 16 Diode characteristics

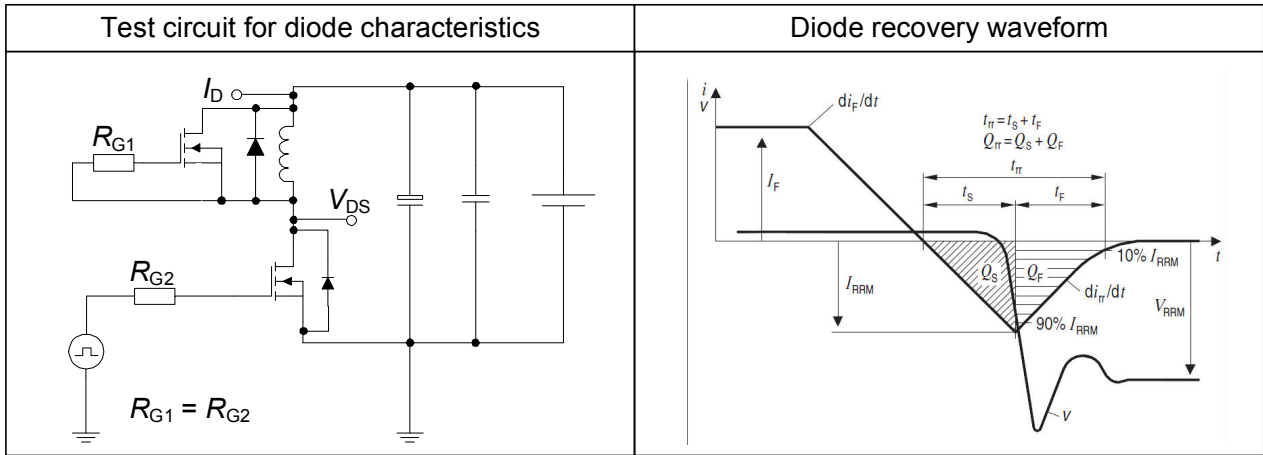

Table 17 Switching times

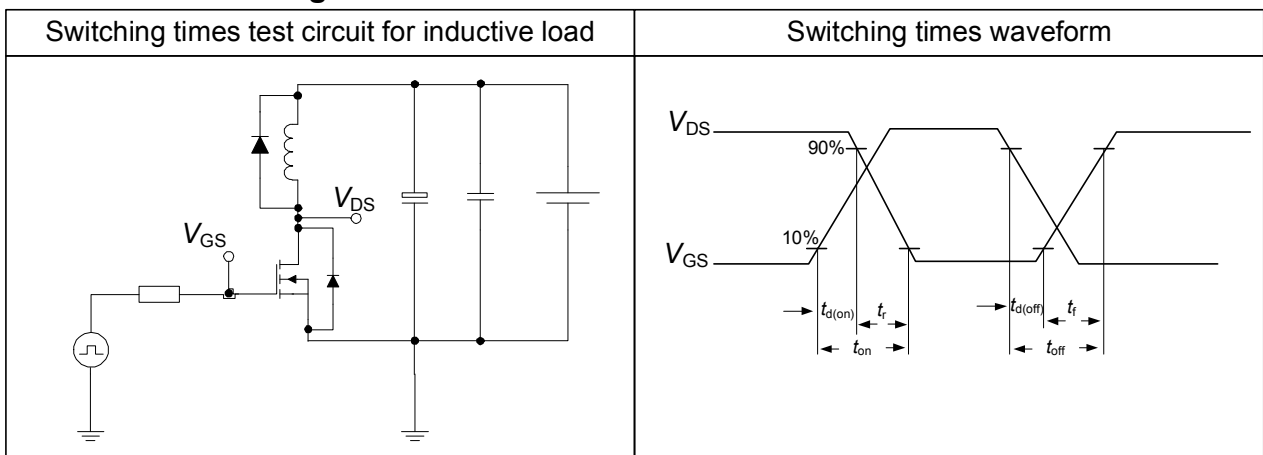
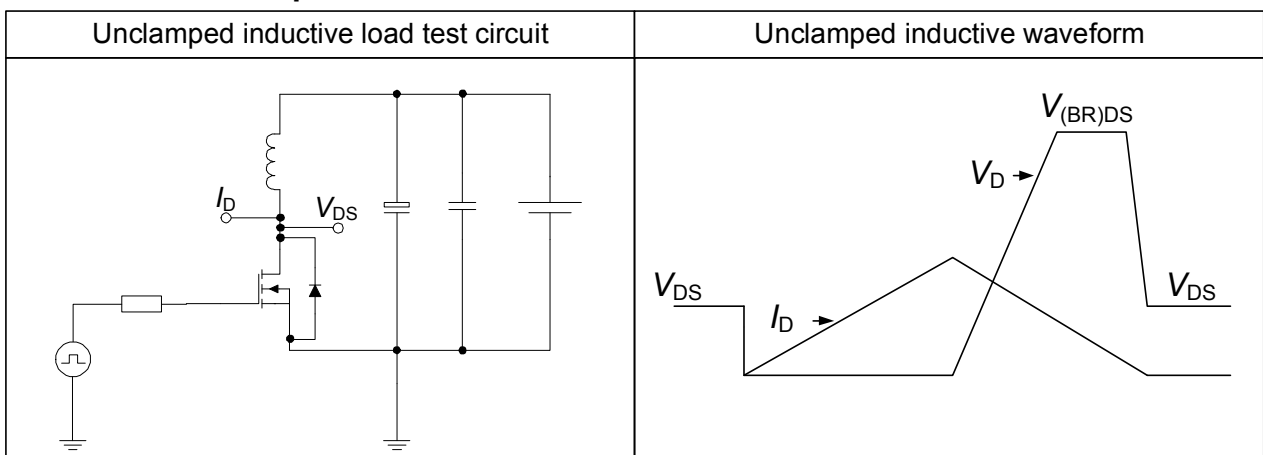

Table 18 Unclamped inductive



7 Package Outlines

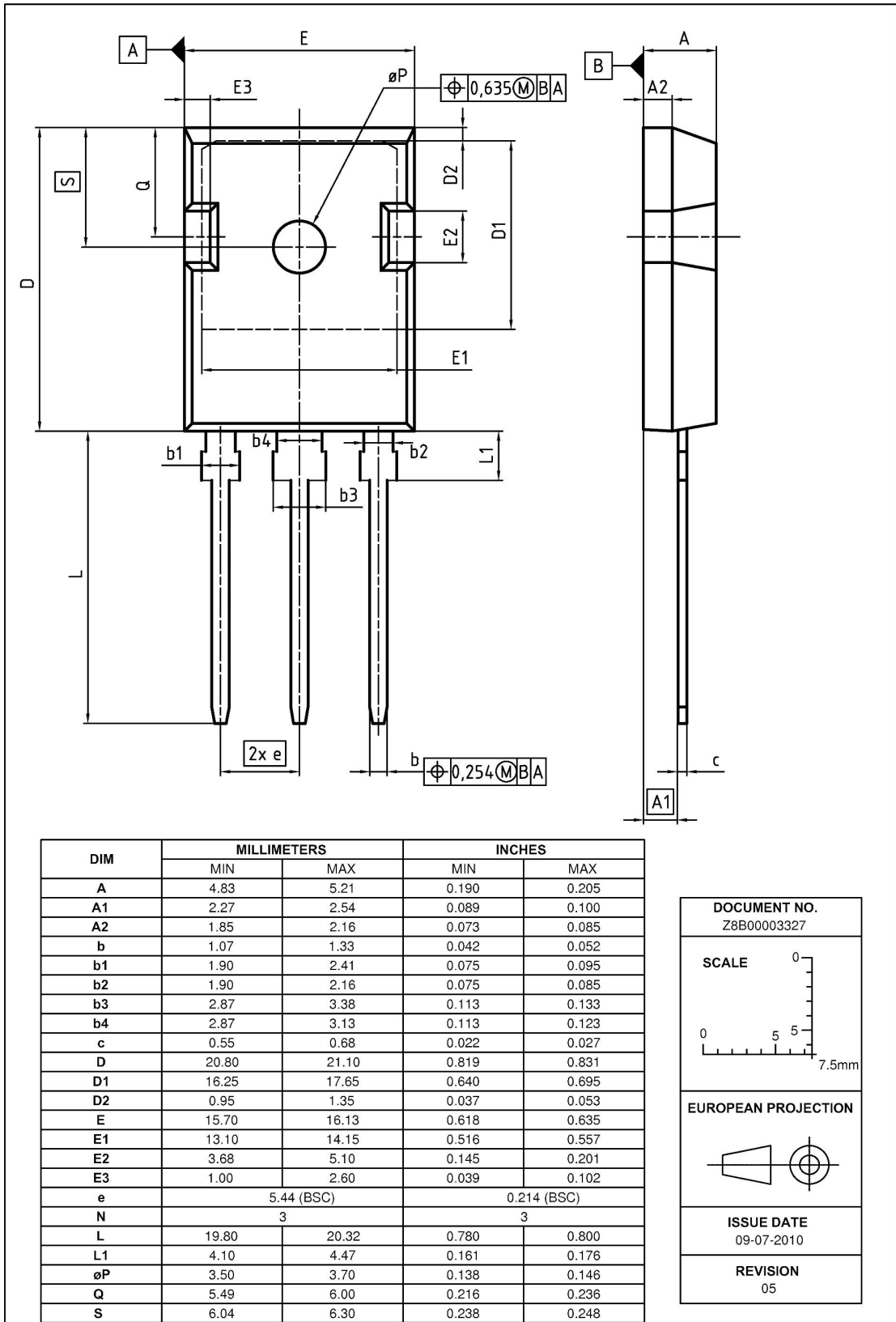

Figure 1 Outline PG-TO 247, dimensions in mm/inches

Revision History

IPW65R048CFDA

Revision: 2012-03-28, Rev. 2.0

Previous Revision

Revision	Date	Subjects (major changes since last revision)
2.0	2012-03-28	Final datasheet

Disclaimer ATV

We Listen to Your Comments

Any information within this document that you feel is wrong, unclear or missing at all? Your feedback will help us to continuously improve the quality of this document. Please send your proposal (including a reference to this document) to: erratum@infineon.com

Edition 2011-09-30

Published by

Infineon Technologies AG**81726 München, Germany****© 2011 Infineon Technologies AG****All Rights Reserved.**

Legal Disclaimer

The information given in this document shall in no event be regarded as a guarantee of conditions or characteristics ("Beschaffenheitsgarantie"). With respect to any examples or hints given herein, any typical values stated herein and/or any information regarding the application of the device, Infineon Technologies hereby disclaims any and all warranties and liabilities of any kind, including without limitation warranties of non-infringement of intellectual property rights of any third party.

Information

For further information on technology, delivery terms and conditions and prices please contact your nearest Infineon Technologies Office (www.infineon.com).

Warnings

Due to technical requirements components may contain dangerous substances. For information on the types in question please contact your nearest Infineon Technologies Office.

Infineon Technologies Components may only be used in life-support devices or systems with the express written approval of Infineon Technologies, if a failure of such components can reasonably be expected to cause the failure of that life-support device or system, or to affect the safety or effectiveness of that device or system. Life support devices or systems are intended to be implanted in the human body, or to support and/or maintain and sustain and/or protect human life.

If they fail, it is reasonable to assume that the health of the user or other persons may be endangered.