

# LE RTDUW S2WN

## OSRAM OSTAR® Stage

Compact lightsource in SMT technology, glass window on top, RoHS compliant

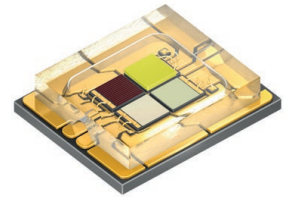

### Applications

- Architecture
- Mood Lighting
- Stage Lighting (LED & Laser)

### Features:

- Package: compact lightsource in multi chip SMT technology with glass window on top
- Chip technology: Thinfilm / UX:3
- Typ. Radiation: 120° (Lambertian emitter)
- Color:  $\lambda_{\text{dom}} = 625 \text{ nm}$  (● red);  $\lambda_{\text{dom}} = 525 \text{ nm}$  (● true green);  $\lambda_{\text{dom}} = 453 \text{ nm}$  (● deep blue);  $C_x = 0.31, C_y = 0.32$  acc. to CIE 1931 (● ultra white)
- Corrosion Robustness Class: 3B
- ESD: 2 kV acc. to ANSI/ESDA/JEDEC JS-001 (HBM, Class 2)

### Ordering Information

Type	Brightness <sup>1)</sup>	Ordering Code
LERTDUWS2WN-KBLA-1+MANA-P+AXAZ-P+MBNB-CQ		Q65112A5474
● red	● $\Phi_V = 90 \dots 140 \text{ lm}$ ( $I_F = 1000 \text{ mA}$ )	
● true green	● $\Phi_V = 180 \dots 355 \text{ lm}$ ( $I_F = 1000 \text{ mA}$ )	
● deep blue	● $\Phi_E = 1120 \dots 1800 \text{ mW}$ ( $I_F = 1000 \text{ mA}$ )	
● ultra white	● $\Phi_V = 224 \dots 450 \text{ lm}$ ( $I_F = 1000 \text{ mA}$ )	

## Maximum Ratings

Parameter	Symbol		Values	Values	Values	Values
			● red	● true green	● deep blue	● ultra white
Operating Temperature	$T_{op}$	min.	-40 °C	-40 °C	-40 °C	-40 °C
		max.	85 °C	85 °C	85 °C	85 °C
Storage Temperature	$T_{stg}$	min.	-40 °C	-40 °C	-40 °C	-40 °C
		max.	85 °C	85 °C	85 °C	85 °C
Junction Temperature	$T_j$	max.	125 °C	150 °C	150 °C	150 °C
Forward Current $T_s = 25\text{ °C}$	$I_F$	min.	40 mA	40 mA	40 mA	40 mA
		max.	2500 mA	3000 mA	3000 mA	3000 mA
ESD withstand voltage acc. to ANSI/ESDA/ JEDEC JS-001 (HBM, Class 2)	$V_{ESD}$		2 kV	2 kV	2 kV	2 kV
Reverse current <sup>2)</sup>	$I_R$	max.	200 mA	200 mA	200 mA	200 mA

## Characteristics

$I_F = 1000 \text{ mA}$ ;  $T_S = 25 \text{ °C}$

Parameter	Symbol		Values			
			● red	● true green	● deep blue	● ultra white
Chromaticity Coordinate						0.31 0.32
Peak Wavelength	$\lambda_{\text{peak}}$	typ.	633 nm	519 nm	448 nm	
Dominant Wavelength <sup>3)</sup>	$\lambda_{\text{dom}}$	min.	620 nm	519 nm	449 nm	
		typ. <sup>3)</sup>	625 nm	525 nm	453 nm	
		max.	632 nm	531 nm	458 nm	
Spectral bandwidth at 50% $I_{\text{rel,max}}$	$\Delta\lambda$	typ.	18 nm	33 nm	25 nm	
Viewing angle at 50% $I_V$	$2\varphi$	typ.	120 °	120 °	120 °	130 °
Radiating surface	$A_{\text{color}}$	typ.	2.1 x 2.1 mm <sup>2</sup>	for total radiating surface see red column	for total radiating surface see red column	for total radiating surface see red column
Partial Flux acc. CIE 127:2007 <sup>4)</sup>	$\Phi_{\text{EV}, 120^\circ}$	typ.	0.82	0.82	0.82	0.77
	$\Phi_{\text{EV } 120^\circ} = x * \Phi_{\text{EV } 180^\circ}$					
Forward Voltage <sup>5)</sup> $I_F = 1000 \text{ mA}$	$V_F$	min.	1.85 V	3.00 V	2.70 V	2.70 V
		typ.	2.35 V	3.60 V	3.00 V	3.00 V
		max.	2.80 V	4.10 V	3.40 V	3.40 V
Reverse voltage (ESD device)	$V_{\text{RESD}}$	min.	45 V	45 V	45 V	45 V
Reverse voltage <sup>2)</sup> $I_R = 20 \text{ mA}$	$V_R$	max.	1.2 V	1.2 V	1.2 V	1.2 V
Real thermal resistance junction/solder-point <sup>6)</sup>	$R_{\text{thJS real}}$	typ.	1.20 K / W	1.20 K / W	1.20 K / W	1.20 K / W
		max.	1.40 K / W	1.40 K / W	1.40 K / W	1.40 K / W
Electrical thermal resistance junction/solderpoint <sup>6)</sup> with efficiency $\eta_e = 26 \%$	$R_{\text{thJS elec.}}$	typ.	0.89 K / W	0.89 K / W	0.89 K / W	0.89 K / W
		max.	1.04 K / W	1.04 K / W	1.04 K / W	1.04 K / W

## Brightness Groups

Color of emission	Group	Luminous Flux <sup>1)</sup> $I_F = 1000 \text{ mA}$ min. $\Phi_V$	Luminous Flux <sup>1)</sup> $I_F = 1000 \text{ mA}$ max. $\Phi_V$
● red	KB	90 lm	112 lm
● red	LA	112 lm	140 lm
● true green	MA	180 lm	224 lm
● true green	MB	224 lm	280 lm
● true green	NA	280 lm	355 lm
● deep blue	AX	1120 mW	1300 mW
● deep blue	AY	1300 mW	1500 mW
● deep blue	AZ	1500 mW	1800 mW
● ultra white	MB	224 lm	280 lm
● ultra white	NA	280 lm	355 lm
● ultra white	NB	355 lm	450 lm

## Wavelength Groups

- true green

Group	Dominant Wavelength <sup>3)</sup> min. $\lambda_{\text{dom}}$	Dominant Wavelength <sup>3)</sup> max. $\lambda_{\text{dom}}$
3	519 nm	525 nm
4	525 nm	531 nm

## Wavelength Groups

- deep blue

Group	Dominant Wavelength <sup>3)</sup> min. $\lambda_{\text{dom}}$	Dominant Wavelength <sup>3)</sup> max. $\lambda_{\text{dom}}$
3	449 nm	453 nm
4	453 nm	458 nm

## Chromaticity Coordinate Groups

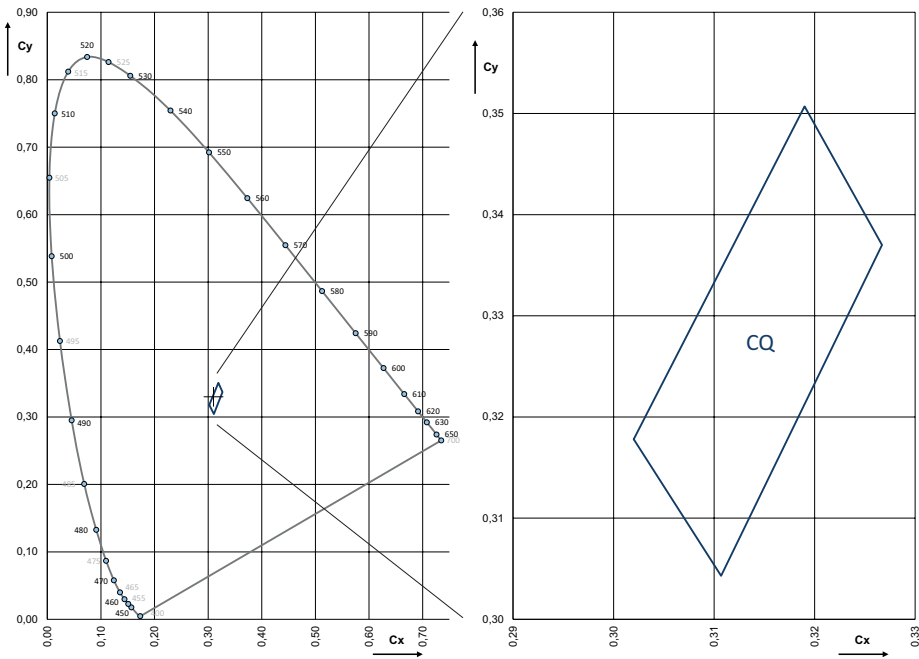

## Color Chromaticity Groups <sup>7)</sup>

- ultra white

Group	Cx	Cy
CQ	0.3190	0.3507
	0.3267	0.3370
	0.3107	0.3043
	0.3020	0.3178

Relative Spectral Emission <sup>4)</sup>

$\Phi_{rel} = f(\lambda); I_F = 1000 \text{ mA}; T_J = 25 \text{ }^\circ\text{C}$

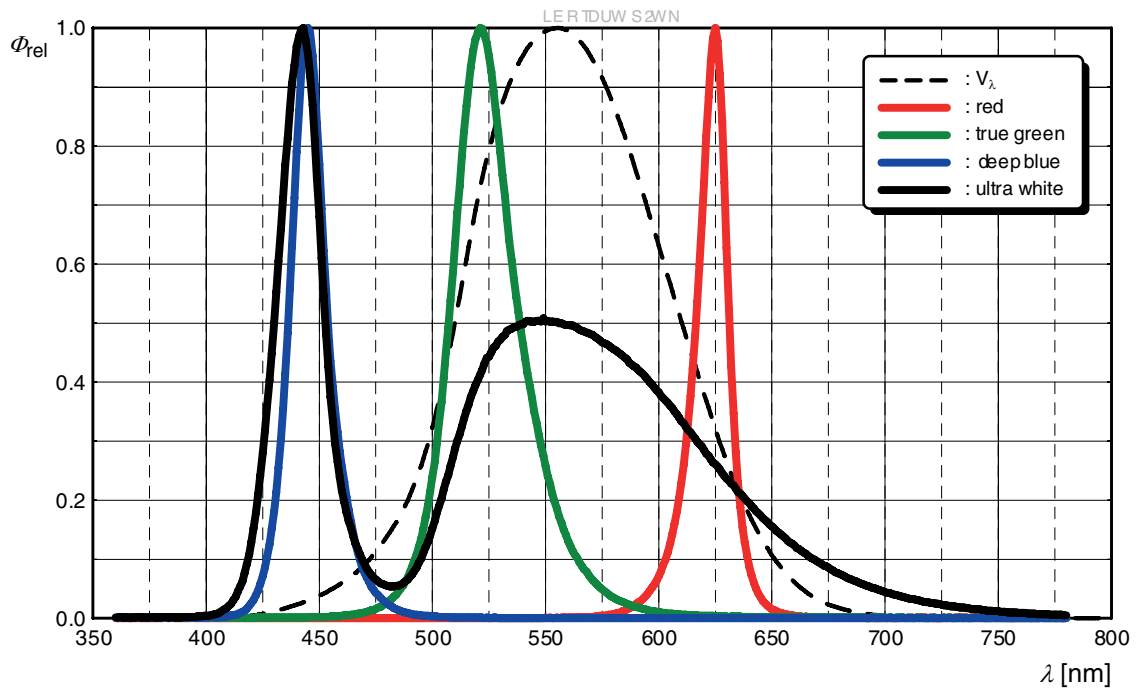

**Radiation Characteristics** <sup>4)</sup>

$I_{rel} = f(\phi)$ ;  $T_J = 25\text{ °C}$ ; red; ture green; blue

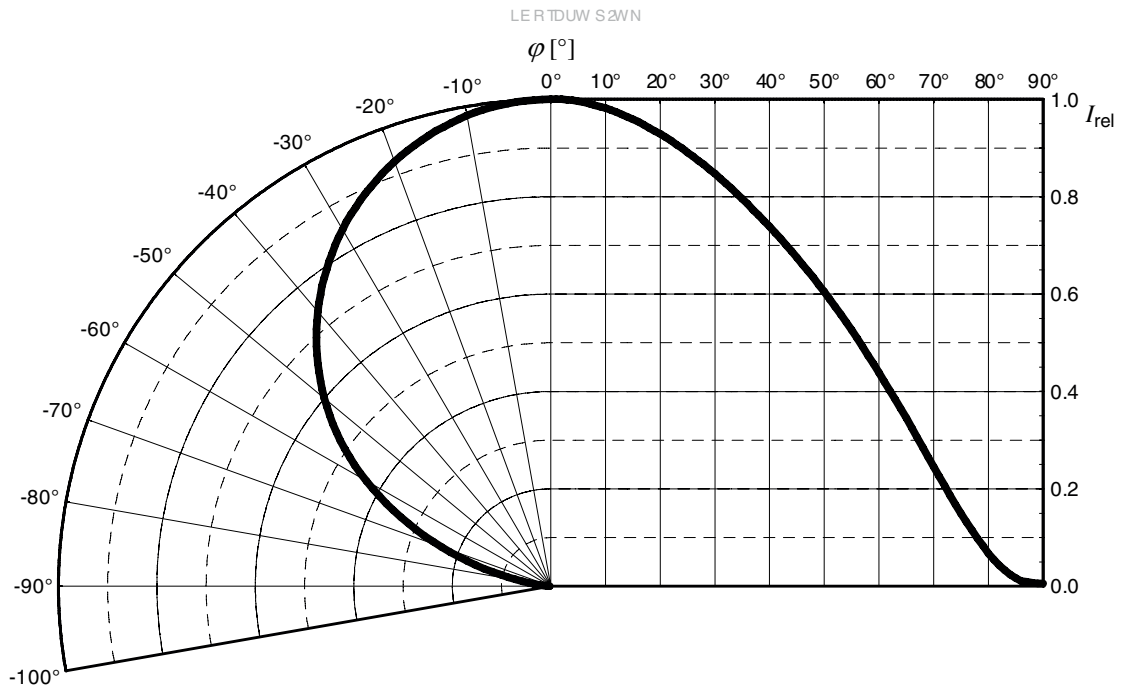

**Radiation Characteristics** <sup>4)</sup>

$I_{rel} = f(\phi)$ ;  $T_J = 25\text{ °C}$ ; ultra white

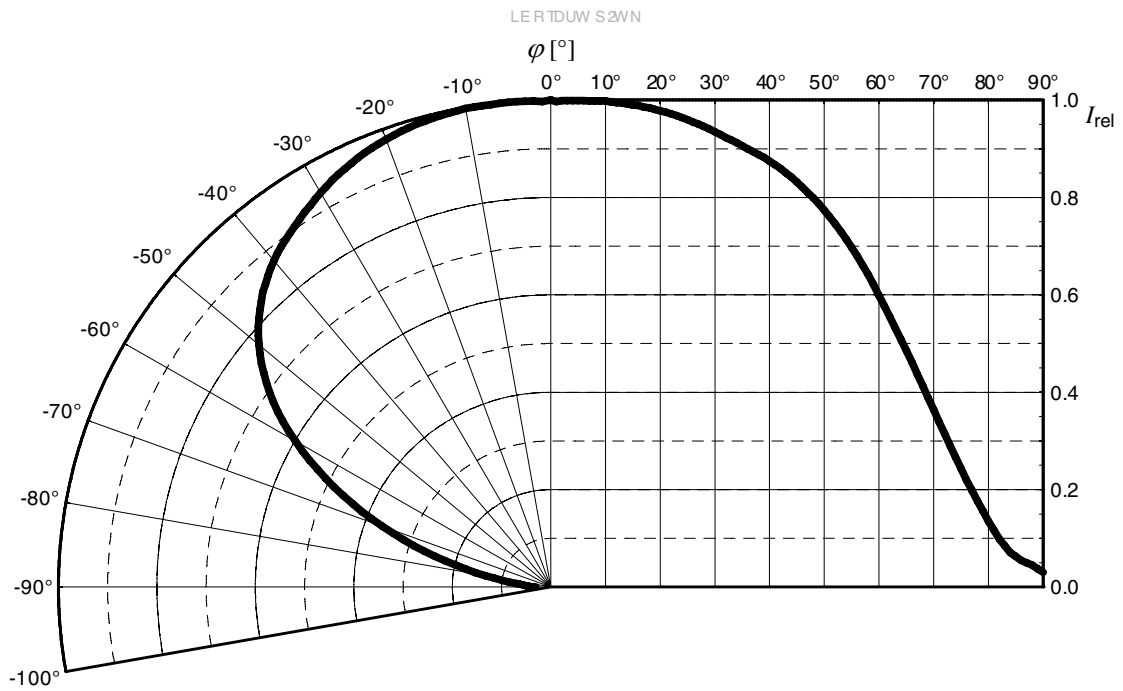

**Relative Partial Flux** <sup>4)</sup>

$\Phi_{EM}(2\varphi)/\Phi_{EM}(180^\circ) = f(\varphi)$ ;  $T_j = 25^\circ\text{C}$ ; red; true green; blue

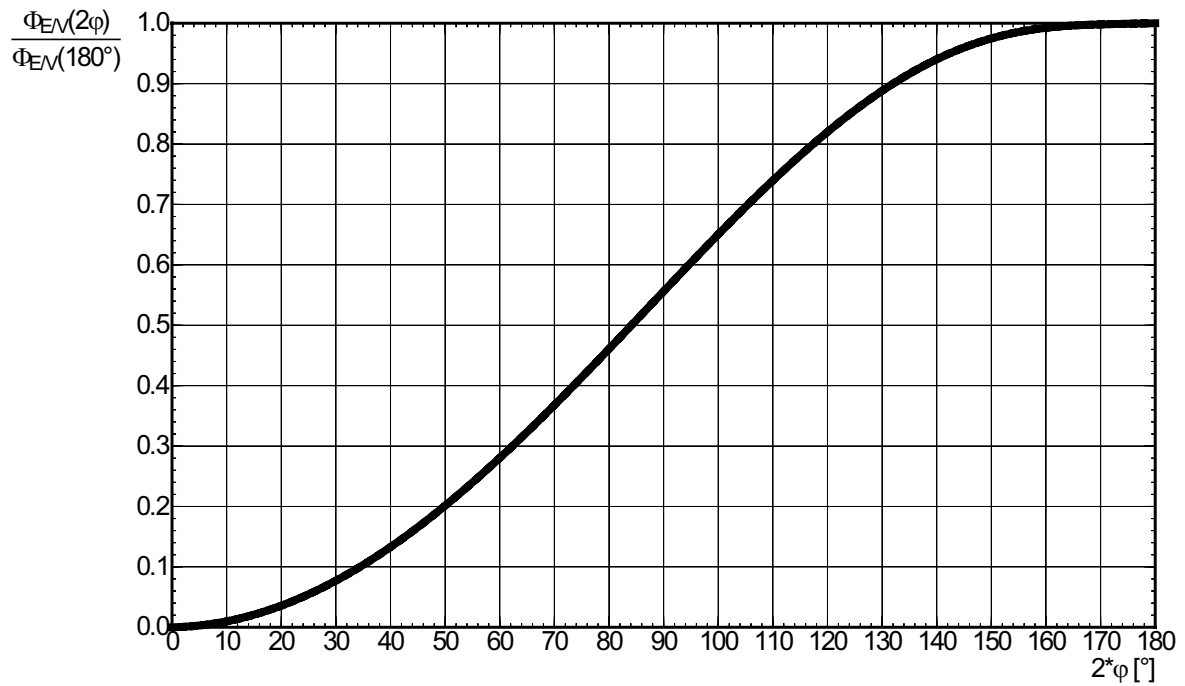

**Relative Partial Flux** <sup>4)</sup>

$\Phi_V(2\varphi)/\Phi_V(180^\circ) = f(\varphi)$ ;  $T_j = 25^\circ\text{C}$ ; ultra white

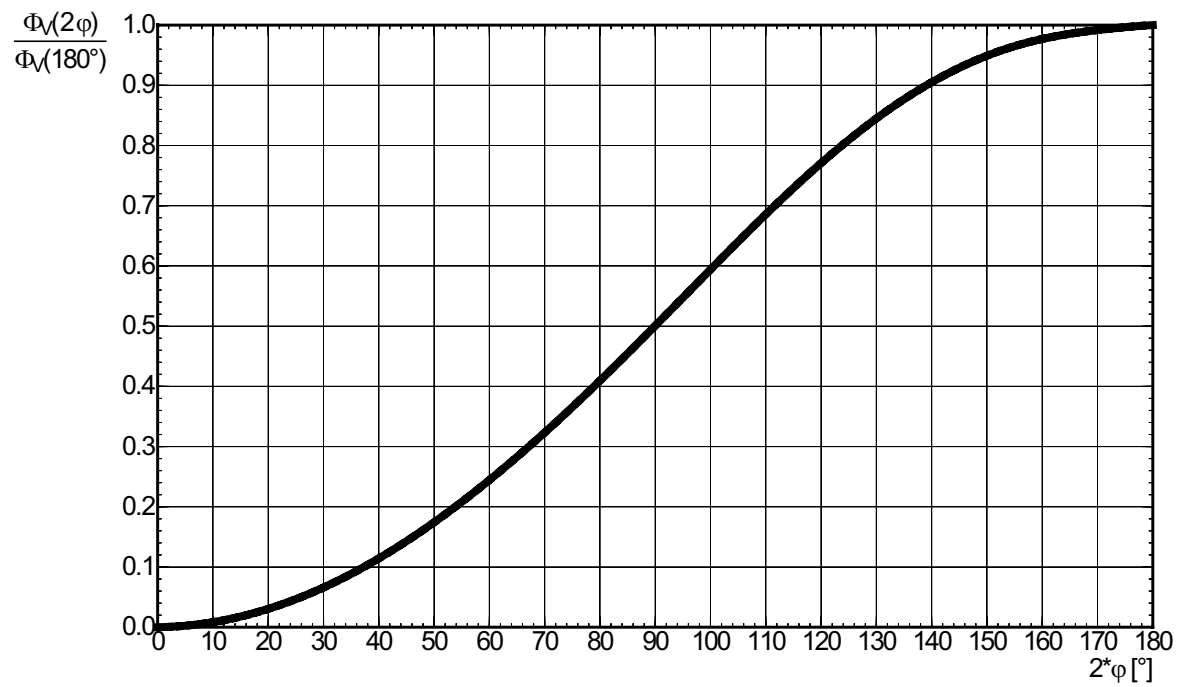



**Forward current** 4), 8)

$I_F = f(V_F); T_J = 25\text{ °C}$

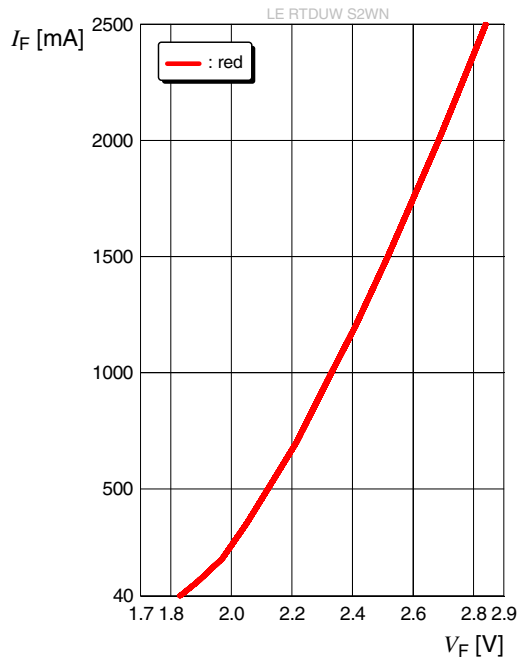

**Forward current** 4), 8)

$I_F = f(V_F); T_J = 25\text{ °C}$

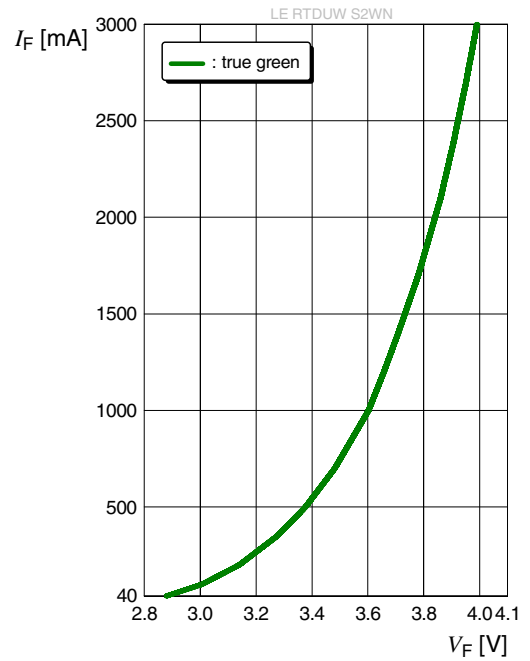

**Forward current** 4), 8)

$I_F = f(V_F); T_J = 25\text{ °C}$

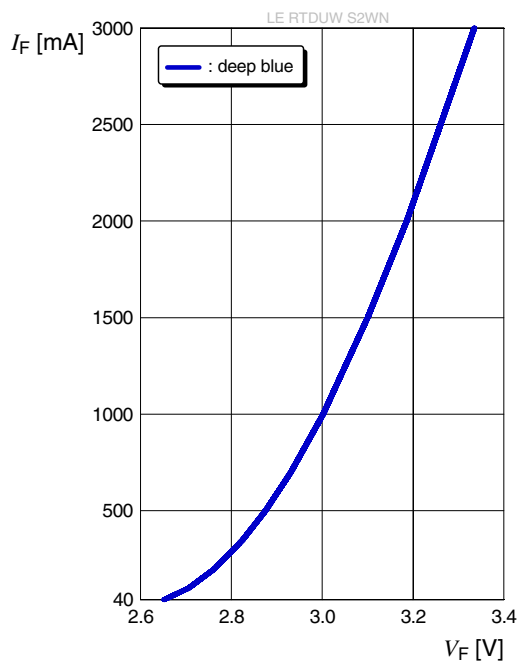

**Forward current** 4), 8)

$I_F = f(V_F); T_J = 25\text{ °C}$

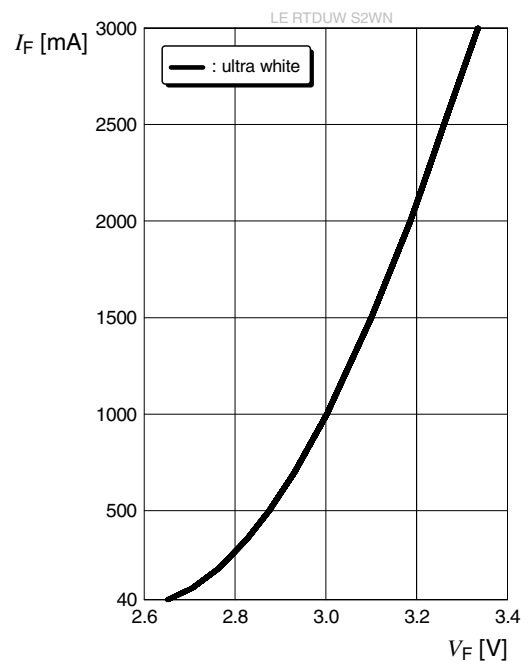

**Relative Luminous Flux** 4), 8)

$\Phi_V/\Phi_V(1000\text{ mA}) = f(I_F); T_J = 25\text{ }^\circ\text{C}$

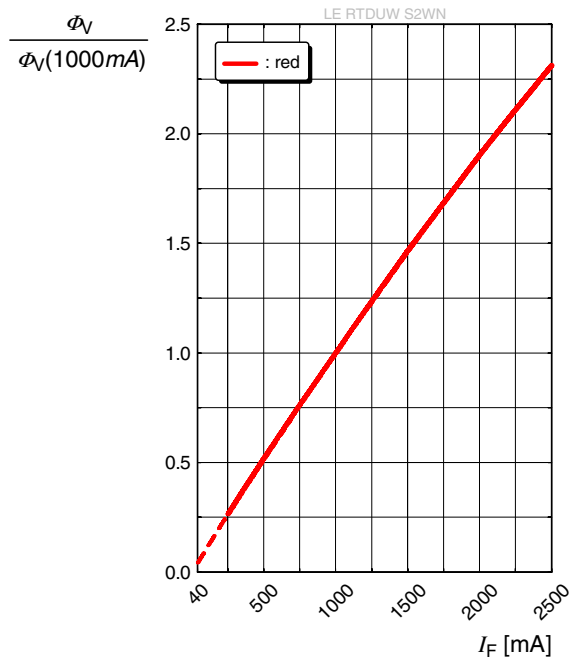

**Relative Luminous Flux** 4), 8)

$\Phi_V/\Phi_V(1000\text{ mA}) = f(I_F); T_J = 25\text{ }^\circ\text{C}$

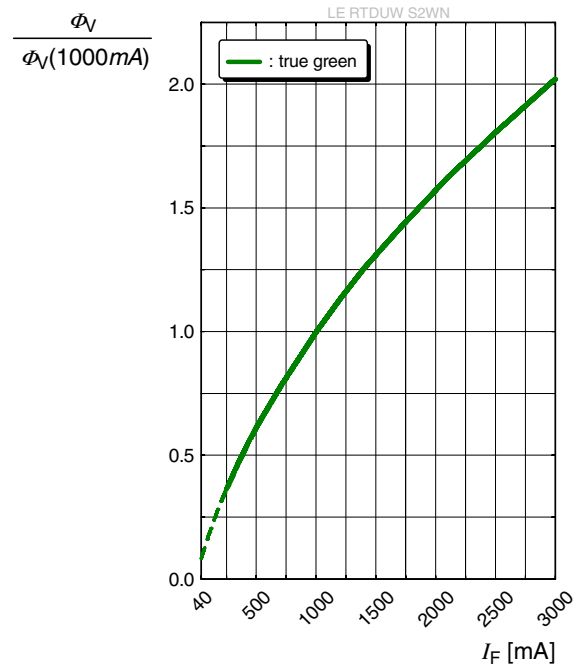

**Relative Radiant Power** 4), 8)

$\Phi_E/\Phi_E(1000\text{ mA}) = f(I_F); T_J = 25\text{ }^\circ\text{C}$

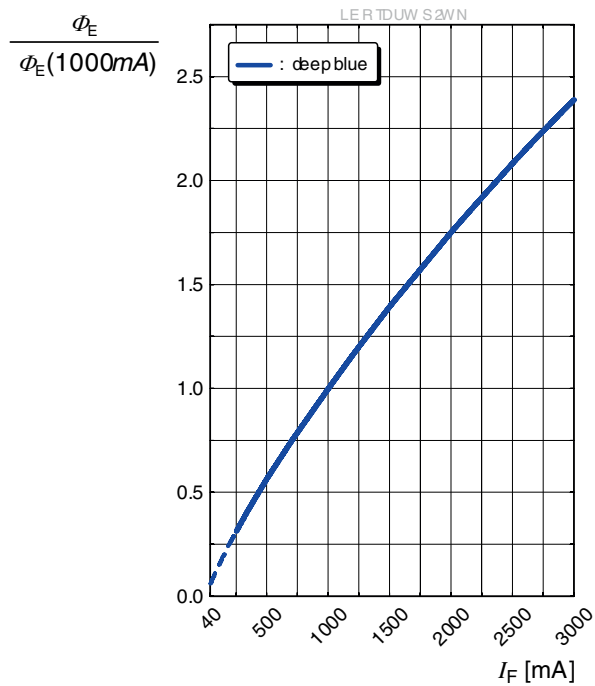

**Relative Luminous Flux** 4), 8)

$\Phi_V/\Phi_V(1000\text{ mA}) = f(I_F); T_J = 25\text{ }^\circ\text{C}$

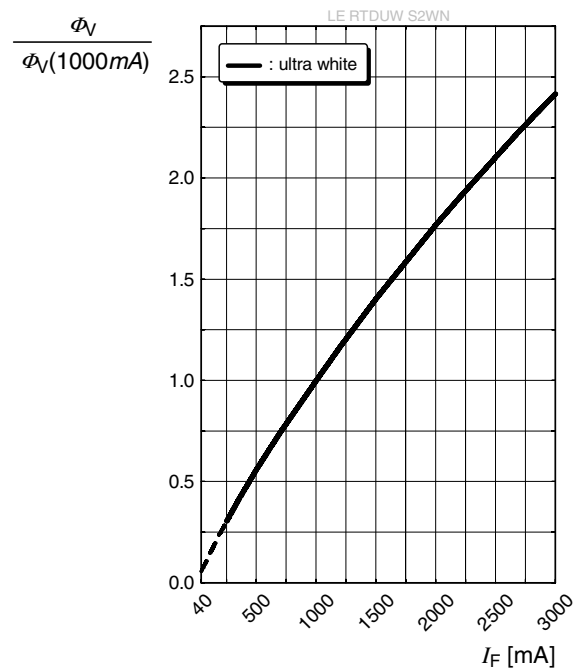

### Dominant Wavelength <sup>4)</sup>

$$\Delta\lambda_{\text{dom}} = f(I_F); T_J = 25 \text{ }^\circ\text{C}$$

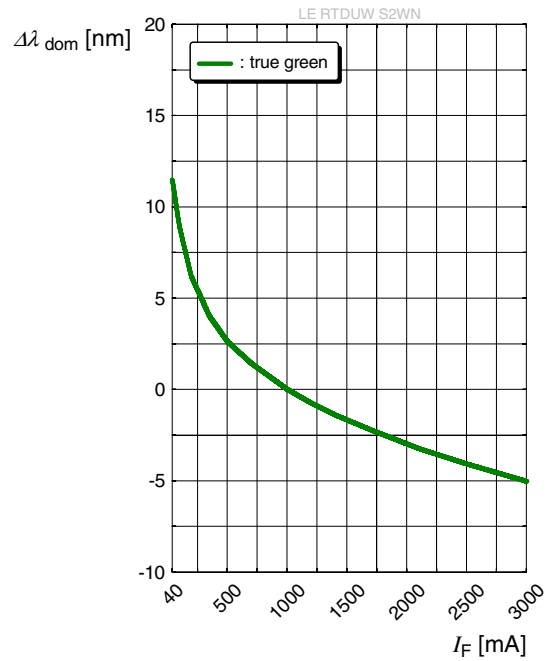

### Dominant Wavelength <sup>4)</sup>

$$\Delta\lambda_{\text{dom}} = f(I_F); T_J = 25 \text{ }^\circ\text{C}$$

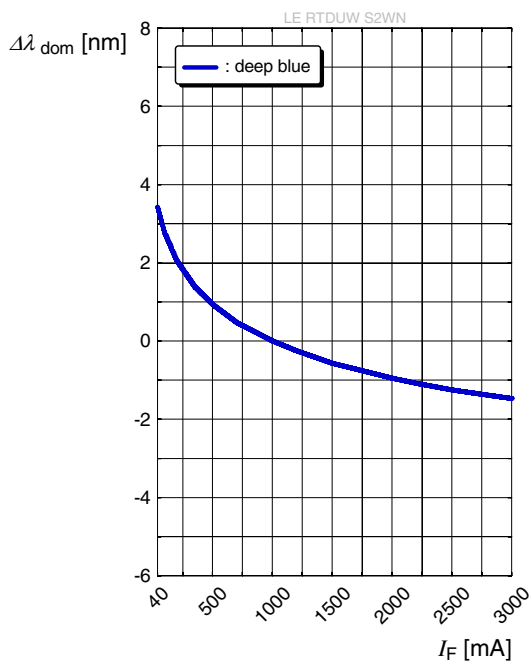

### Chromaticity Coordinate Shift <sup>4)</sup>

$$\Delta C_x, \Delta C_y = f(I_F); T_J = 25 \text{ }^\circ\text{C}$$

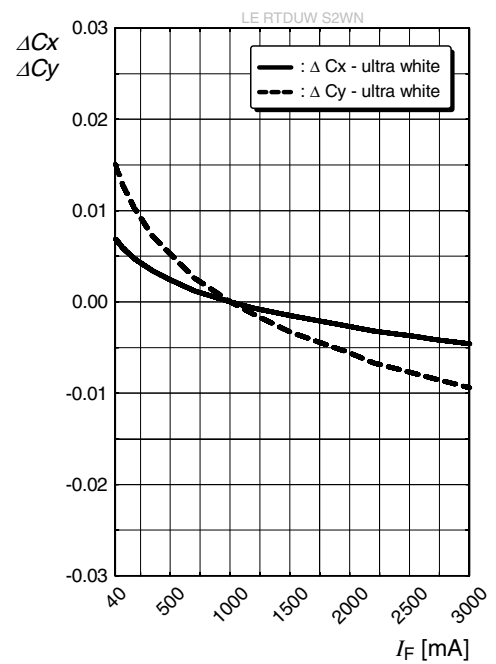

**Forward Voltage** <sup>4)</sup>

$$\Delta V_F = V_F - V_F(25\text{ }^\circ\text{C}) = f(T_j); I_F = 1000\text{ mA}$$

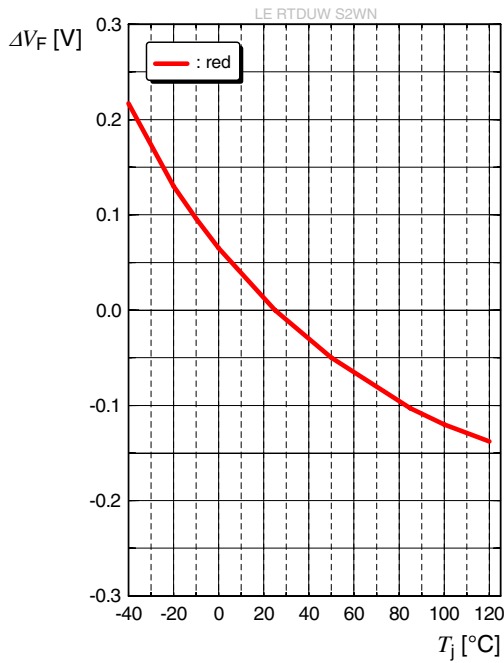

**Forward Voltage** <sup>4)</sup>

$$\Delta V_F = V_F - V_F(25\text{ }^\circ\text{C}) = f(T_j); I_F = 1000\text{ mA}$$

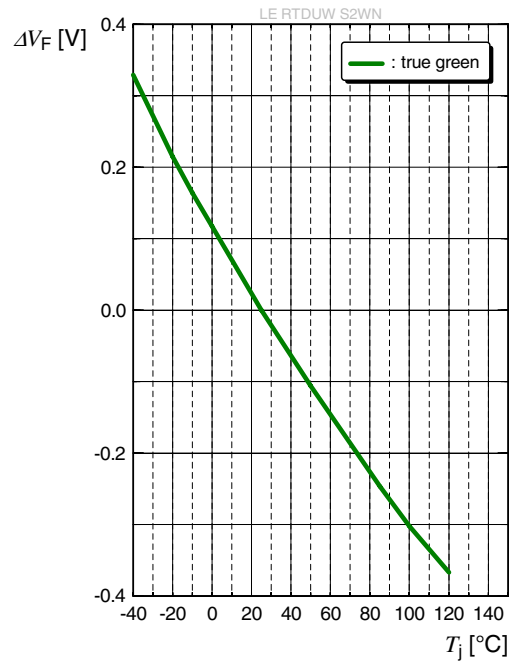

**Forward Voltage** <sup>4)</sup>

$$\Delta V_F = V_F - V_F(25\text{ }^\circ\text{C}) = f(T_j); I_F = 1000\text{ mA}$$

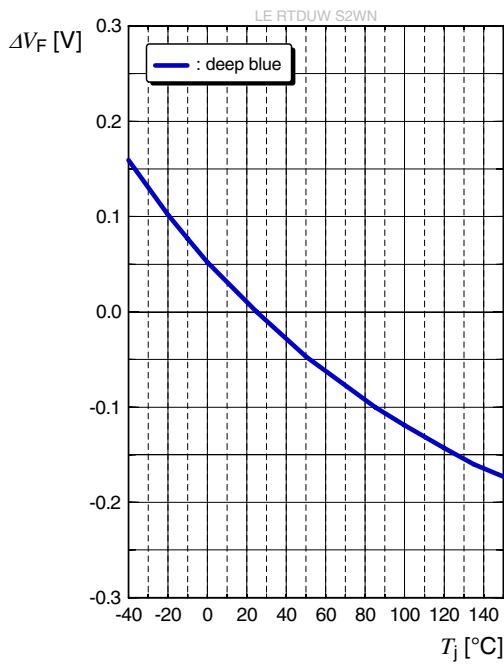

**Forward Voltage** <sup>4)</sup>

$$\Delta V_F = V_F - V_F(25\text{ }^\circ\text{C}) = f(T_j); I_F = 1000\text{ mA}$$

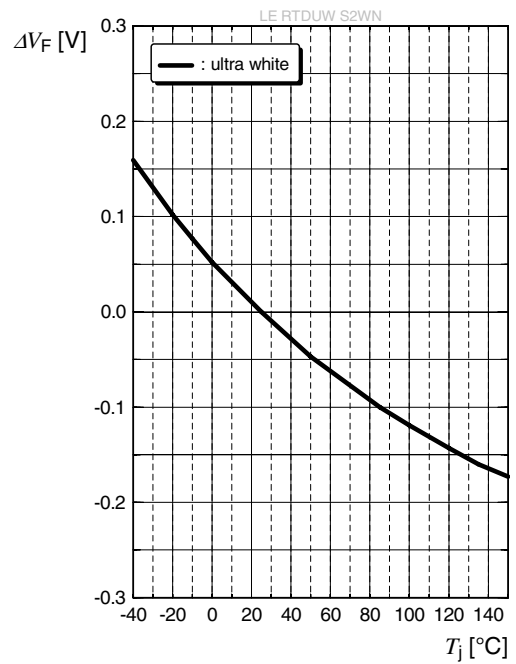

**Relative Luminous Flux** <sup>4)</sup>

$\Phi_v / \Phi_v(25\text{ °C}) = f(T_j); I_F = 1000\text{ mA}$

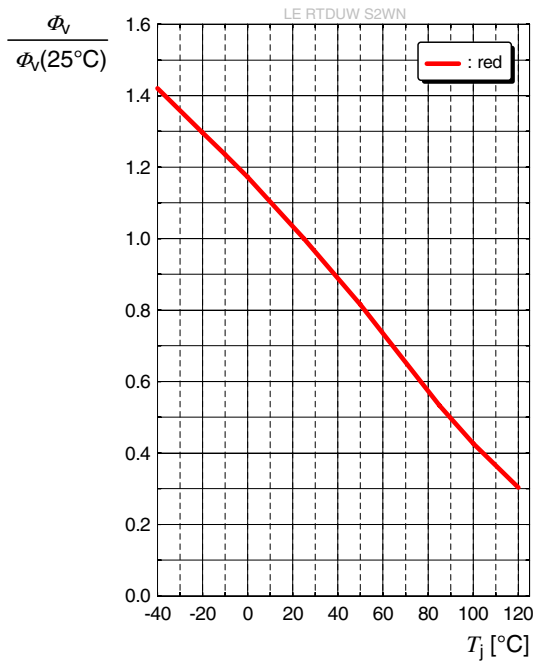

**Relative Luminous Flux** <sup>4)</sup>

$\Phi_v / \Phi_v(25\text{ °C}) = f(T_j); I_F = 1000\text{ mA}$

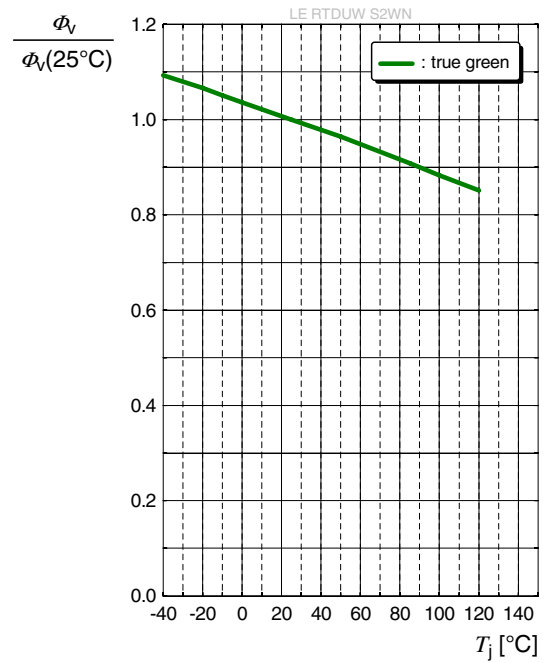

**Relative Radiant Power** <sup>4)</sup>

$\Phi_E / \Phi_E(25\text{ °C}) = f(T_j); I_F = 1000\text{ mA}$

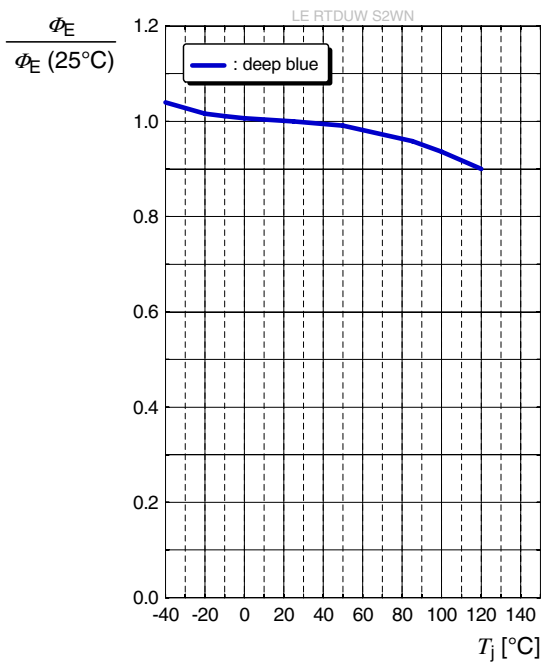

**Relative Luminous Flux** <sup>4)</sup>

$\Phi_v / \Phi_v(25\text{ °C}) = f(T_j); I_F = 1000\text{ mA}$

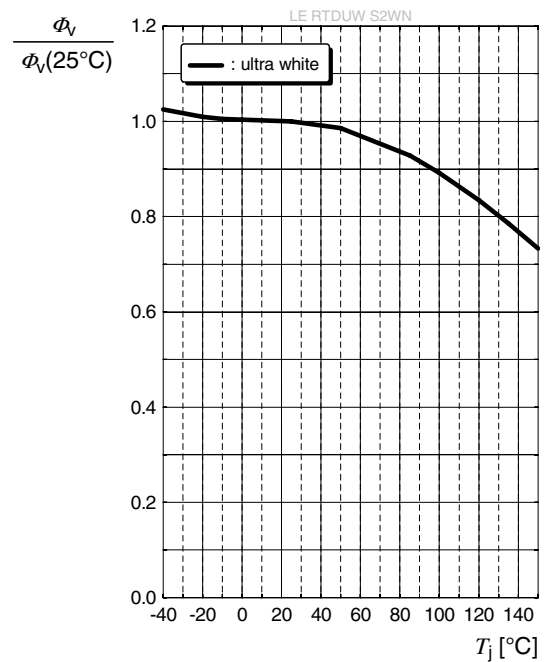

### Chromaticity Coordinate Shift <sup>4)</sup>

$$\Delta C_x, \Delta C_y = f(T_j); I_F = 1000 \text{ mA}$$

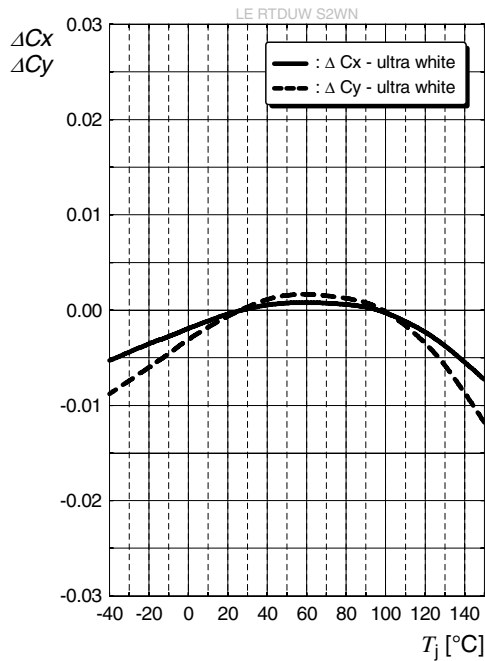

### Dominant Wavelength <sup>4)</sup>

$$\Delta \lambda_{\text{dom}} = \lambda_{\text{dom}} - \lambda_{\text{dom}}(25 \text{ °C}) = f(T_j); I_F = 1000 \text{ mA}$$

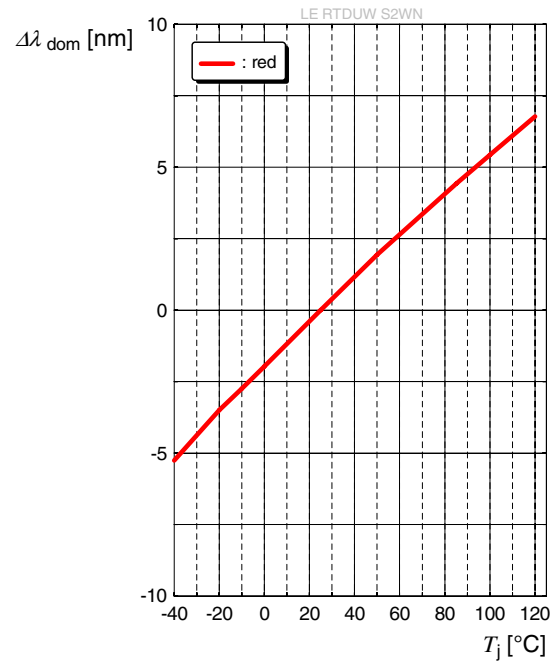

### Dominant Wavelength <sup>4)</sup>

$$\Delta \lambda_{\text{dom}} = \lambda_{\text{dom}} - \lambda_{\text{dom}}(25 \text{ °C}) = f(T_j); I_F = 1000 \text{ mA}$$

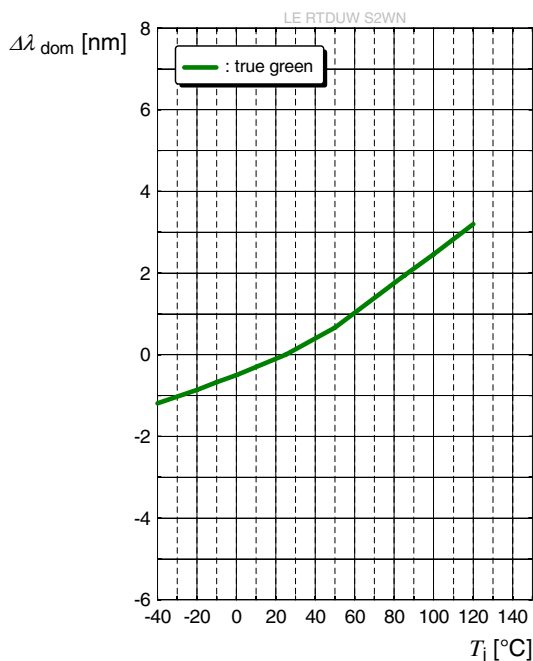

### Dominant Wavelength <sup>4)</sup>

$$\Delta \lambda_{\text{dom}} = \lambda_{\text{dom}} - \lambda_{\text{dom}}(25 \text{ °C}) = f(T_j); I_F = 1000 \text{ mA}$$

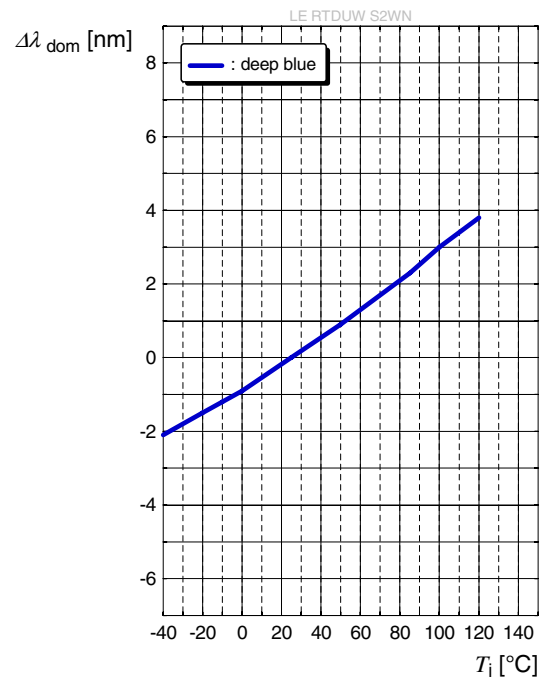

## Max. Permissible Forward Current

$$I_F = f(T)$$

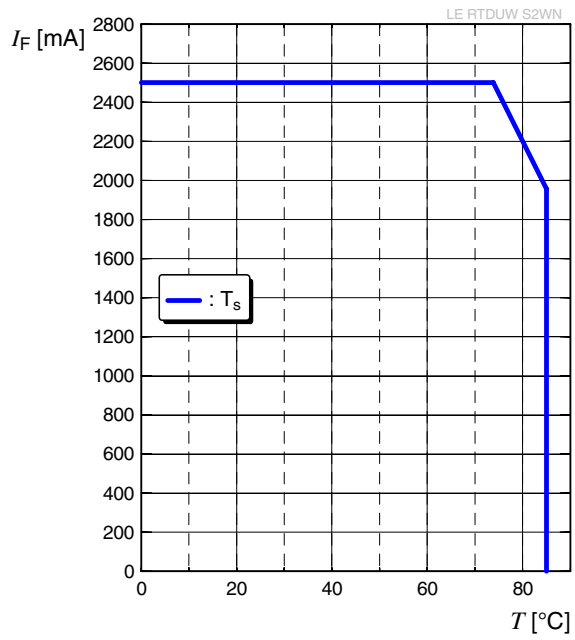

Dimensional Drawing <sup>9)</sup>

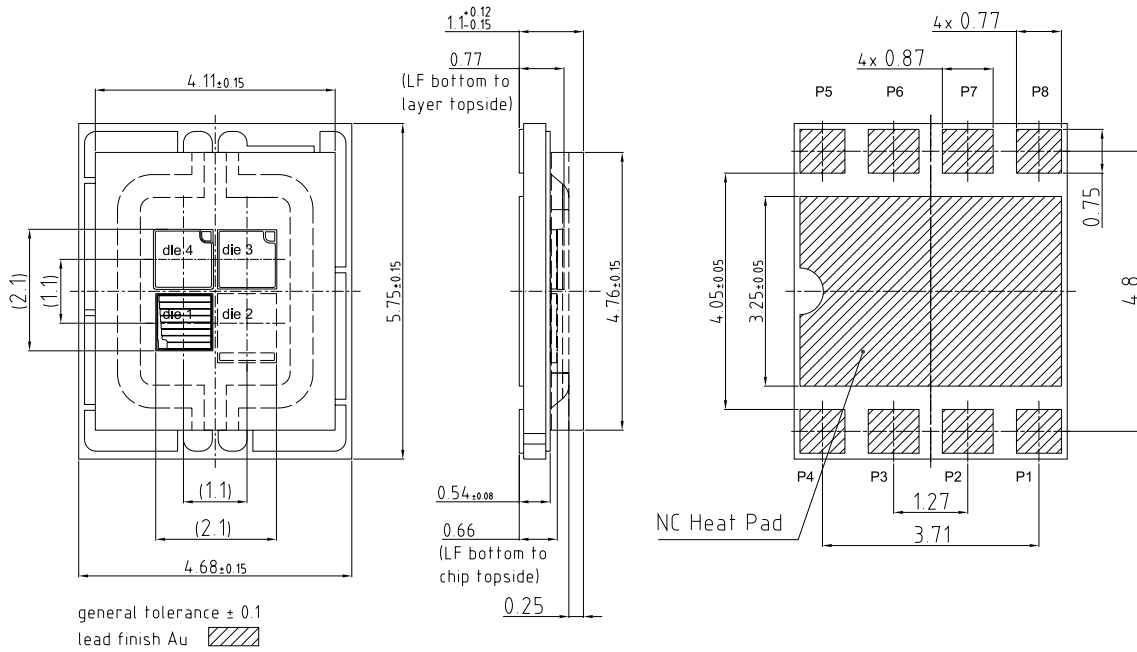

C67062-A4278-A3-03

**Approximate Weight:** 91.0 mg

**Corrosion test:** Class: 3B  
 Test condition: 40°C / 90 % RH / 15 ppm H<sub>2</sub>S / 14 days (stricter then IEC 60068-2-43)

**ESD advice:** The device is protected by ESD device which is connected in parallel to the Chip.



## Electrical internal circuit

Pinning :

P1 Cathode die 1  
P2 Anode die 1

P5 Cathode die 3  
P6 Anode die 3

P3 Cathode die 2  
P4 Anode die 2

P7 Cathode die 4  
P8 Anode die 4

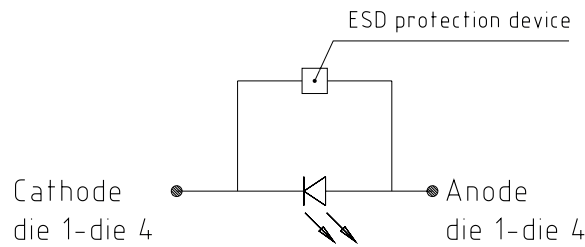

Colors :

die 1: red  
die 2: deep blue  
die 3: true green  
die 4: ultra white

## Recommended Solder Pad <sup>9)</sup>

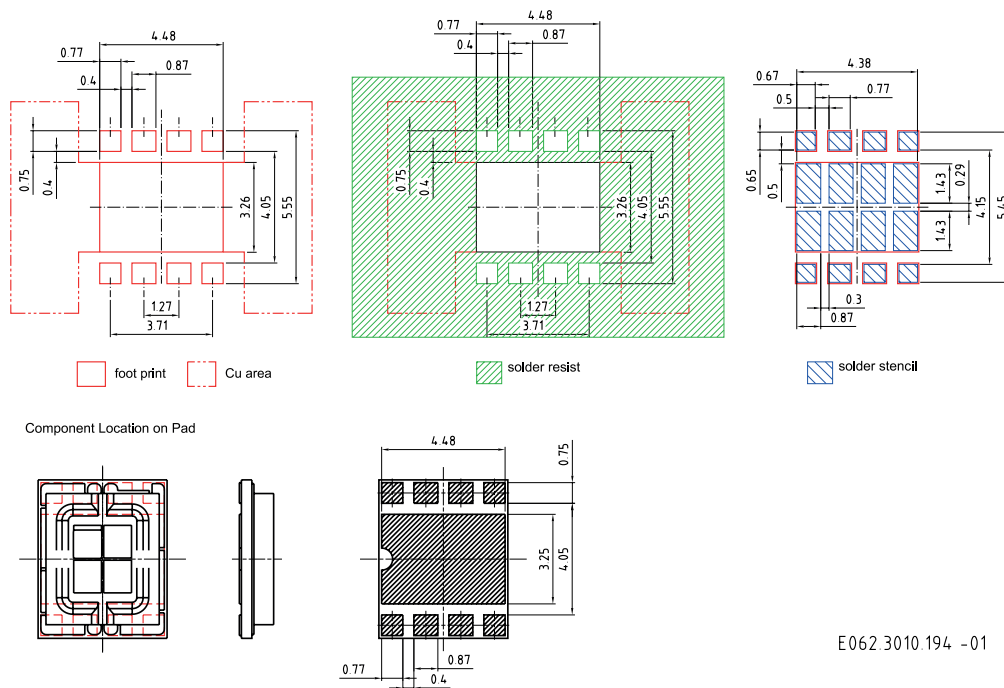

E062.3010.194 -01

For superior solder joint connectivity results we recommend soldering under standard nitrogen atmosphere. Package not suitable for any kind of wet cleaning or ultrasonic cleaning.

## Reflow Soldering Profile

Product complies to MSL Level 2 acc. to JEDEC J-STD-020E

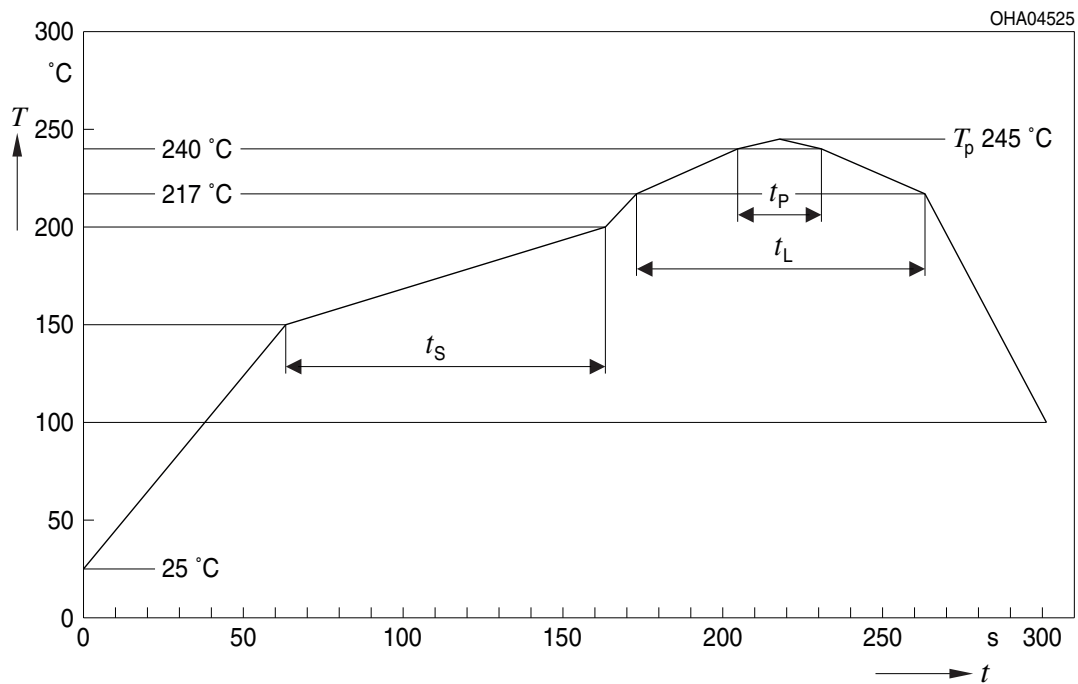

Profile Feature	Symbol	Pb-Free (SnAgCu) Assembly			Unit
		Minimum	Recommendation	Maximum	
Ramp-up rate to preheat <sup>*)</sup> 25 °C to 150 °C			2	3	K/s
Time $t_s$ $T_{Smin}$ to $T_{Smax}$	$t_s$	60	100	120	s
Ramp-up rate to peak <sup>*)</sup> $T_{Smax}$ to $T_p$			2	3	K/s
Liquidus temperature	$T_L$		217		°C
Time above liquidus temperature	$t_L$		80	100	s
Peak temperature	$T_p$		245	260	°C
Time within 5 °C of the specified peak temperature $T_p - 5$ K	$t_p$	10	20	30	s
Ramp-down rate* $T_p$ to 100 °C			3	6	K/s
Time 25 °C to $T_p$				480	s

All temperatures refer to the center of the package, measured on the top of the component

\* slope calculation  $DT/Dt$ :  $Dt$  max. 5 s; fulfillment for the whole T-range

Taping <sup>9)</sup>

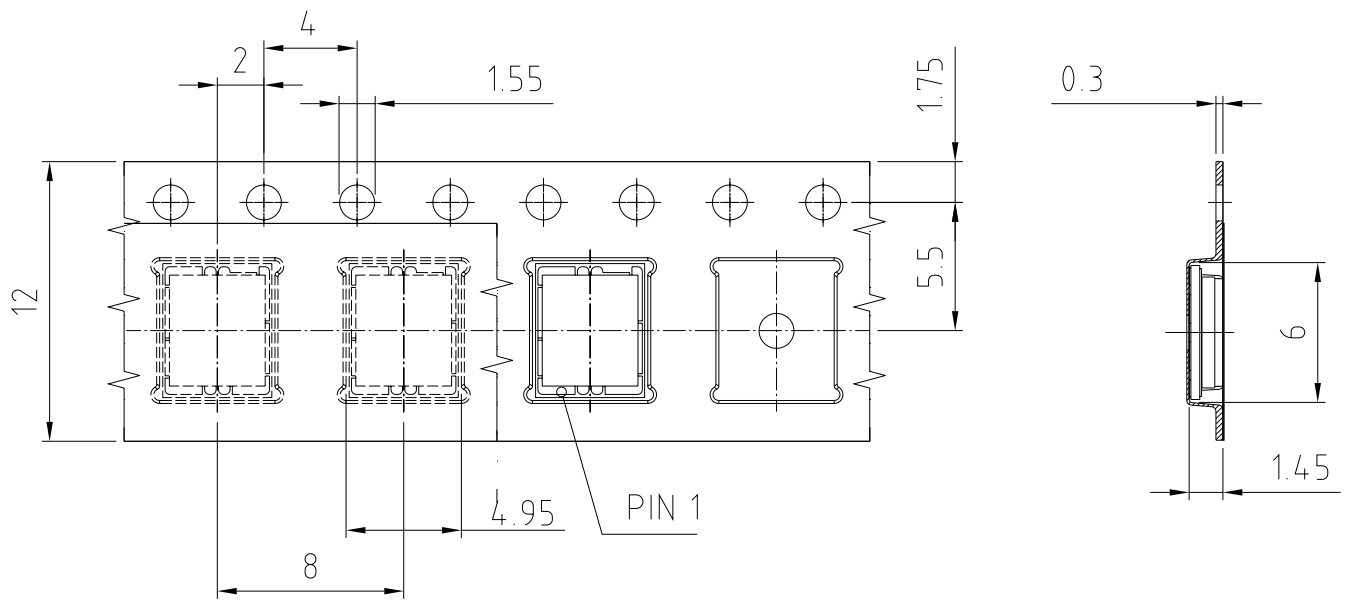

C63062-A4278-B22-01

**Tape and Reel** <sup>10)</sup>

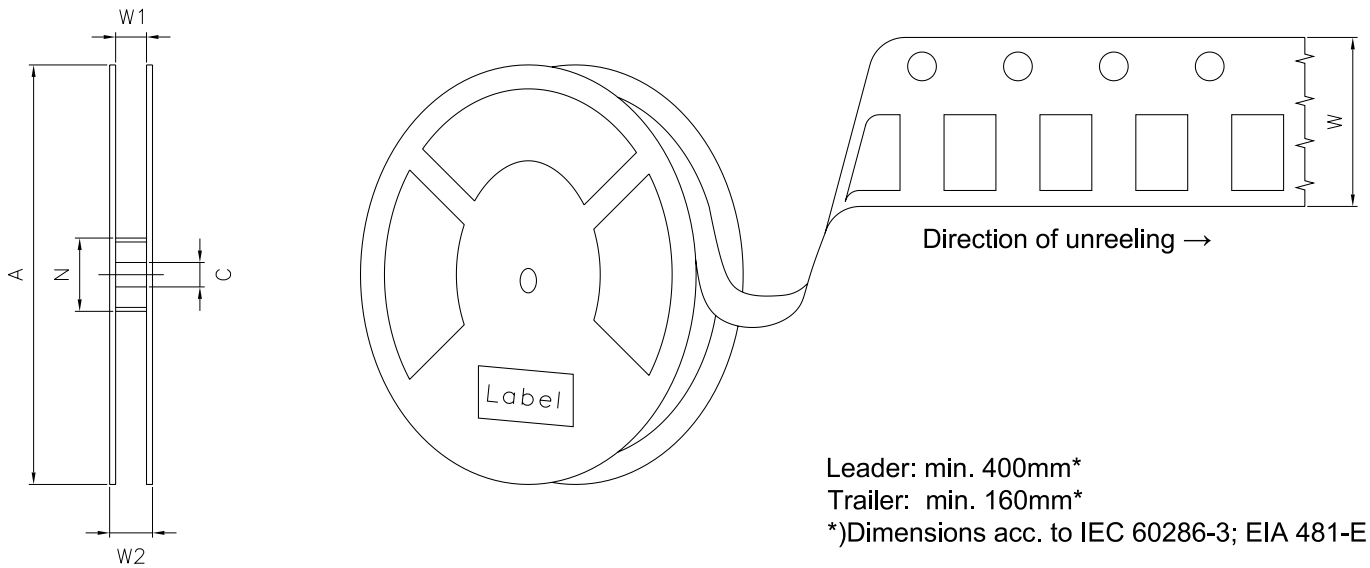

**Reel dimensions [mm]**

A	W	N <sub>min</sub>	W <sub>1</sub>	W <sub>2max</sub>	Pieces per PU
180 mm	12 + 0.3 / - 0.1	60	12.4 + 2	18.4	500

Barcode-Product-Label (BPL)

**OSRAM Opto Semiconductors** LX XXXX BIN1: XX-XX-X-XXX-X

RoHS Compliant



(6P) BATCH NO: 1234567890

(1T) LOT NO: 1234567890 (9D) D/C: 1234

(X) PROD NO: 123456789 (Q) QTY: 9999 (G) GROUP: XX-XX-X-X

ML Temp ST  
X XXX °C X

Pack: RXX  
DEMY XXX  
X\_X123\_1234.1234 X



OHA04563

### Dry Packing Process and Materials <sup>9)</sup>

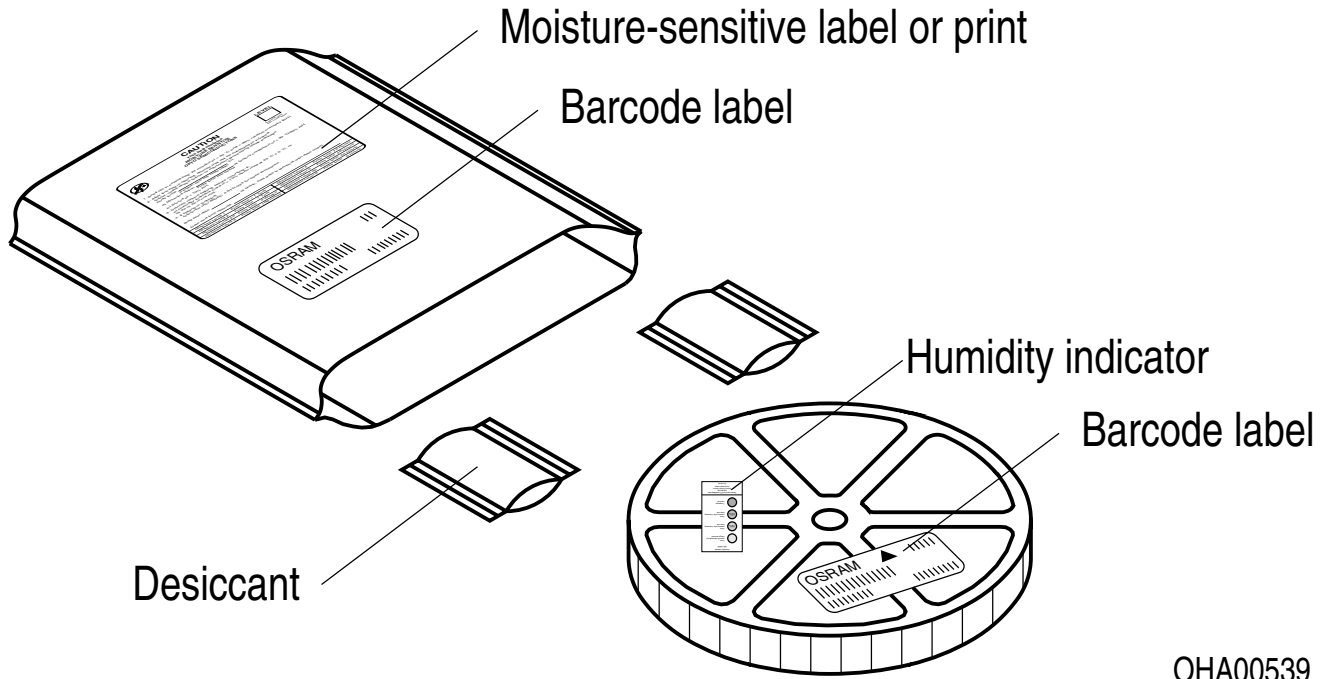

OHA00539

Moisture-sensitive product is packed in a dry bag containing desiccant and a humidity card according JEDEC-STD-033.

### Transportation Packing and Materials <sup>9)</sup>

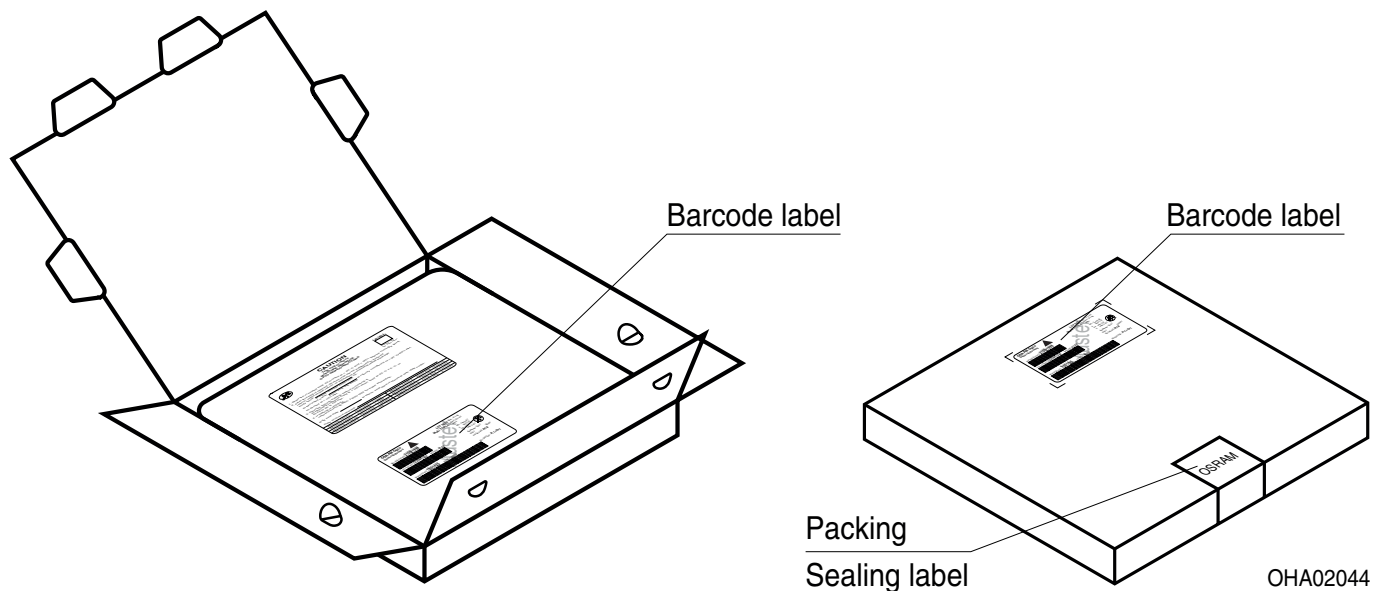

OHA02044

---

### Dimensions of transportation box in mm

Width	Length	Height
195 ± 5 mm	195 ± 5 mm	30 ± 5 mm

---

## Type Designation System

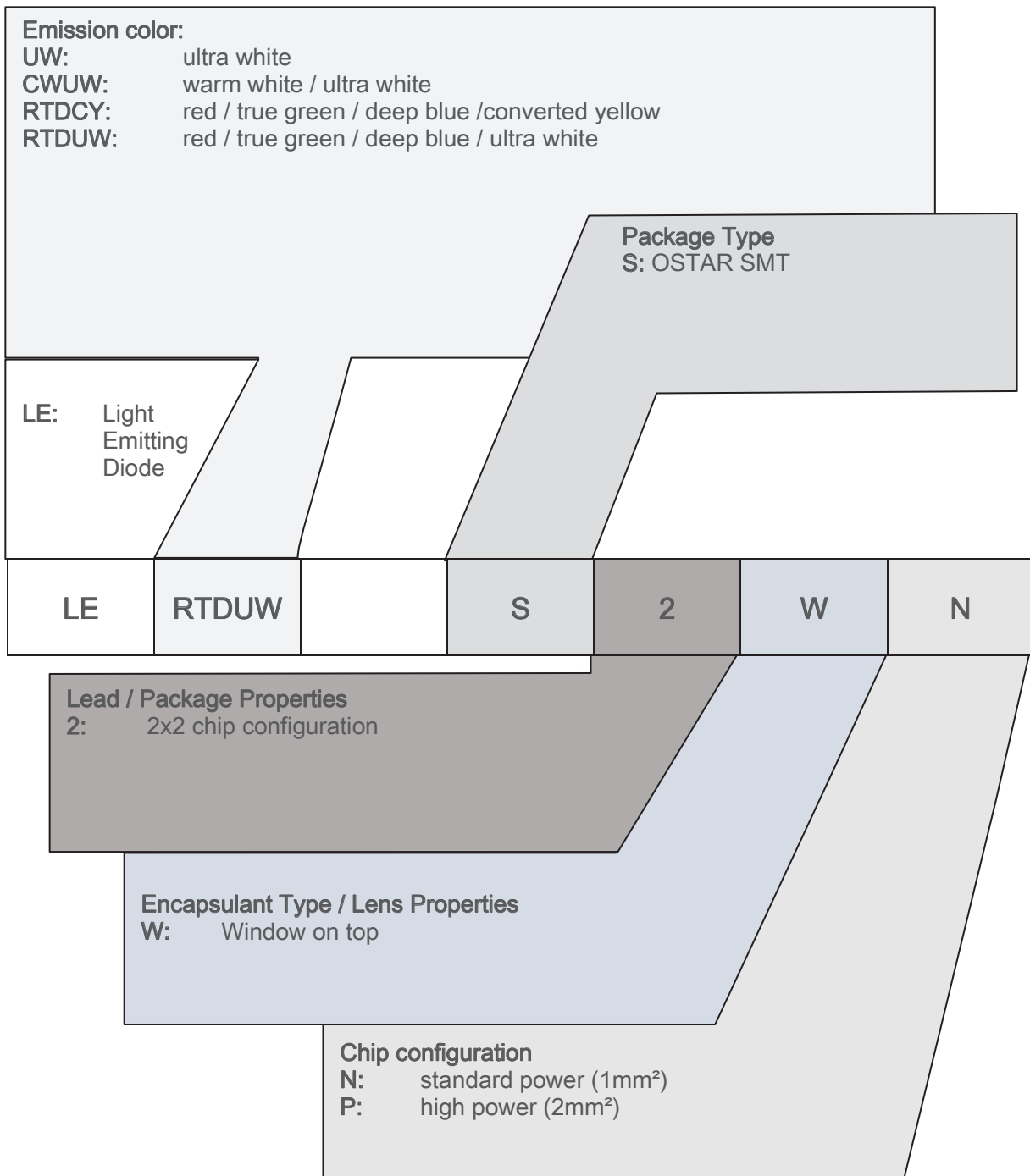



## Notes

The evaluation of eye safety occurs according to the standard IEC 62471:2006 (photo biological safety of lamps and lamp systems). Within the risk grouping system of this IEC standard, the device specified in this data sheet falls into the class **moderate risk (exposure time 0.25 s)**. Under real circumstances (for exposure time, conditions of the eye pupils, observation distance), it is assumed that no endangerment to the eye exists from these devices. As a matter of principle, however, it should be mentioned that intense light sources have a high secondary exposure potential due to their blinding effect. When looking at bright light sources (e.g. headlights), temporary reduction in visual acuity and afterimages can occur, leading to irritation, annoyance, visual impairment, and even accidents, depending on the situation.

Subcomponents of this device contain, in addition to other substances, metal filled materials including silver. Metal filled materials can be affected by environments that contain traces of aggressive substances. Therefore, we recommend that customers minimize device exposure to aggressive substances during storage, production, and use. Devices that showed visible discoloration when tested using the described tests above did show no performance deviations within failure limits during the stated test duration. Respective failure limits are described in the IEC60810.

For further application related informations please visit [www.osram-os.com/appnotes](http://www.osram-os.com/appnotes)

## Disclaimer

### Disclaimer

Language english will prevail in case of any discrepancies or deviations between the two language wordings.

### Attention please!

The information describes the type of component and shall not be considered as assured characteristics. Terms of delivery and rights to change design reserved. Due to technical requirements components may contain dangerous substances.

For information on the types in question please contact our Sales Organization.

If printed or downloaded, please find the latest version on the OSRAM OS website.

### Packing

Please use the recycling operators known to you. We can also help you – get in touch with your nearest sales office.

By agreement we will take packing material back, if it is sorted. You must bear the costs of transport. For packing material that is returned to us unsorted or which we are not obliged to accept, we shall have to invoice you for any costs incurred.

### Product safety devices/applications or medical devices/applications

OSRAM OS components are not developed, constructed or tested for the application as safety relevant component or for the application in medical devices.

In case Buyer – or Customer supplied by Buyer– considers using OSRAM OS components in product safety devices/applications or medical devices/applications, Buyer and/or Customer has to inform the local sales partner of OSRAM OS immediately and OSRAM OS and Buyer and /or Customer will analyze and coordinate the customer-specific request between OSRAM OS and Buyer and/or Customer.

---

## Glossary

- 1) **Brightness:** Brightness values are measured during a current pulse of typically 25 ms, with an internal reproducibility of  $\pm 8\%$  and an expanded uncertainty of  $\pm 11\%$  (acc. to GUM with a coverage factor of  $k = 3$ ).
- 2) **Reverse Operation:** Reverse Operation of 10 hours is permissible in total. Continuous reverse operation is not allowed.
- 3) **Wavelength:** The wavelength is measured at a current pulse of typically 25 ms, with an internal reproducibility of  $\pm 0.5$  nm and an expanded uncertainty of  $\pm 1$  nm (acc. to GUM with a coverage factor of  $k = 3$ ).
- 4) **Typical Values:** Due to the special conditions of the manufacturing processes of semiconductor devices, the typical data or calculated correlations of technical parameters can only reflect statistical figures. These do not necessarily correspond to the actual parameters of each single product, which could differ from the typical data and calculated correlations or the typical characteristic line. If requested, e.g. because of technical improvements, these typ. data will be changed without any further notice.
- 5) **Forward Voltage:** The forward voltage is measured during a current pulse of typically 8 ms, with an internal reproducibility of  $\pm 0.05$  V and an expanded uncertainty of  $\pm 0.1$  V (acc. to GUM with a coverage factor of  $k = 3$ ).
- 6) **Thermal Resistance:**  $R_{th\ max}$  is based on statistic values ( $6\sigma$ ).
- 7) **Chromaticity coordinate groups:** Chromaticity coordinates are measured during a current pulse of typically 25 ms, with an internal reproducibility of  $\pm 0.005$  and an expanded uncertainty of  $\pm 0.01$  (acc. to GUM with a coverage factor of  $k = 3$ ).
- 8) **Characteristic curve:** In the range where the line of the graph is broken, you must expect higher differences between single devices within one packing unit.
- 9) **Tolerance of Measure:** Unless otherwise noted in drawing, tolerances are specified with  $\pm 0.1$  and dimensions are specified in mm.
- 10) **Tape and Reel:** All dimensions and tolerances are specified acc. IEC 60286-3 and specified in mm.

Published by OSRAM Opto Semiconductors GmbH EU RoHS and China RoHS compliant product  
Leibnizstraße 4, D-93055 Regensburg  
www.osram-os.com © All Rights Reserved.



此产品符合欧盟 RoHS 指令的要求；  
按照中国的相关法规和标准，不含有毒有害物质或元素。