



RF Power LDMOS Transistor

N-Channel Enhancement-Mode Lateral MOSFET

This 87 W asymmetrical Doherty RF power LDMOS transistor is designed for cellular base station applications requiring very wide instantaneous bandwidth capability covering the frequency range of 2110 to 2200 MHz.

2100 MHz

- Typical Doherty Single-Carrier W-CDMA Characterization Performance:
 $V_{DD} = 30$ Vdc, $I_{DQA} = 600$ mA, $V_{GSB} = 0.5$ Vdc, $P_{out} = 87$ W Avg., Input Signal PAR = 9.9 dB @ 0.01% Probability on CCDF.

| Frequency | G_{ps} (dB) | η_D (%) | Output PAR (dB) | ACPR (dBc) |
|-----------|---------------|--------------|-----------------|------------|
| 2110 MHz | 15.1 | 48.5 | 8.1 | -30.2 |
| 2155 MHz | 15.7 | 48.9 | 7.9 | -30.2 |
| 2200 MHz | 15.3 | 47.2 | 7.8 | -33.7 |

Features

- Advanced high performance in-package Doherty
- Designed for wide instantaneous bandwidth applications
- Greater negative gate-source voltage range for improved Class C operation
- Able to withstand extremely high output VSWR and broadband operating conditions
- Designed for digital predistortion error correction systems

A3T21H450W23SR6

2110–2200 MHz, 87 W AVG., 30 V AIRFAST RF POWER LDMOS TRANSISTOR



ACP-1230S-4L2S

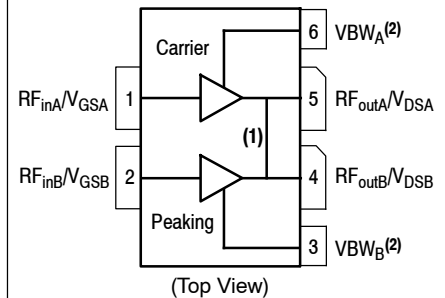

Figure 1. Pin Connections

- Pin connections 4 and 5 are DC coupled and RF independent.
- Device cannot operate with V_{DD} current supplied through pin 3 and pin 6.

Table 1. Maximum Ratings

| Rating | Symbol | Value | Unit |
|--|-----------|-------------|------|
| Drain-Source Voltage | V_{DSS} | -0.5, +65 | Vdc |
| Gate-Source Voltage | V_{GS} | -6.0, +10 | Vdc |
| Operating Voltage | V_{DD} | 32, +0 | Vdc |
| Storage Temperature Range | T_{stg} | -65 to +150 | °C |
| Case Operating Temperature Range | T_C | -40 to +150 | °C |
| Operating Junction Temperature Range (1,2) | T_J | -40 to +225 | °C |

Table 2. Thermal Characteristics

| Characteristic | Symbol | Value (2,3) | Unit |
|--|-----------------|-------------|------|
| Thermal Resistance, Junction to Case Case Temperature 78°C, 87 W Avg., W-CDMA, 30 Vdc, $I_{DQA} = 600$ mA, $V_{GSB} = 0.5$ Vdc, 2155 MHz | $R_{\theta JC}$ | 0.16 | °C/W |

Table 3. ESD Protection Characteristics

| Test Methodology | Class |
|---------------------------------------|-------|
| Human Body Model (per JESD22-A114) | 2 |
| Charge Device Model (per JESD22-C101) | C3 |

Table 4. Electrical Characteristics ($T_A = 25^\circ\text{C}$ unless otherwise noted)

| Characteristic | Symbol | Min | Typ | Max | Unit |
|----------------|--------|-----|-----|-----|------|
|----------------|--------|-----|-----|-----|------|

Off Characteristics (4)

| | | | | | |
|---|-----------|---|---|----|-----------------|
| Zero Gate Voltage Drain Leakage Current ($V_{DS} = 65$ Vdc, $V_{GS} = 0$ Vdc) | I_{DSS} | — | — | 10 | μAdc |
| Zero Gate Voltage Drain Leakage Current ($V_{DS} = 32$ Vdc, $V_{GS} = 0$ Vdc) | I_{DSS} | — | — | 5 | μAdc |
| Gate-Source Leakage Current ($V_{GS} = 5$ Vdc, $V_{DS} = 0$ Vdc) | I_{GSS} | — | — | 1 | μAdc |

On Characteristics - Side A, Carrier

| | | | | | |
|---|--------------|-----|------|-----|-----|
| Gate Threshold Voltage ($V_{DS} = 10$ Vdc, $I_D = 180$ μAdc) | $V_{GS(th)}$ | 1.4 | 1.8 | 2.3 | Vdc |
| Gate Quiescent Voltage ($V_{DD} = 30$ Vdc, $I_D = 600$ mAdc, Measured in Functional Test) | $V_{GSA(Q)}$ | 2.2 | 2.6 | 3.0 | Vdc |
| Drain-Source On-Voltage ($V_{GS} = 10$ Vdc, $I_D = 1.8$ Adc) | $V_{DS(on)}$ | 0.0 | 0.15 | 0.3 | Vdc |

On Characteristics - Side B, Peaking

| | | | | | |
|--|--------------|-----|------|-----|-----|
| Gate Threshold Voltage ($V_{DS} = 10$ Vdc, $I_D = 360$ μAdc) | $V_{GS(th)}$ | 0.8 | 1.2 | 1.6 | Vdc |
| Drain-Source On-Voltage ($V_{GS} = 10$ Vdc, $I_D = 3.6$ Adc) | $V_{DS(on)}$ | 0.0 | 0.15 | 0.3 | Vdc |

1. Continuous use at maximum temperature will affect MTTF.
2. MTTF calculator available at <http://www.nxp.com/RF/calculators>.
3. Refer to AN1955, *Thermal Measurement Methodology of RF Power Amplifiers*. Go to <http://www.nxp.com/RF> and search for AN1955.
4. Side A and Side B are tied together for these measurements.

(continued)

Table 4. Electrical Characteristics ($T_A = 25^\circ\text{C}$ unless otherwise noted) (continued)

| Characteristic | Symbol | Min | Typ | Max | Unit |
|---|----------|------|-------|-------|------|
| Functional Tests ^(1,2,3) (In NXP Doherty Production Test Fixture, 50 ohm system) $V_{DD} = 30\text{ Vdc}$, $I_{DQA} = 600\text{ mA}$, $V_{GSB} = 0.5\text{ Vdc}$, $P_{out} = 87\text{ W Avg.}$, $f = 2200\text{ MHz}$, Single-Carrier W-CDMA, IQ Magnitude Clipping, Input Signal PAR = 9.9 dB @ 0.01% Probability on CCDF. ACPR measured in 3.84 MHz Channel Bandwidth @ $\pm 5\text{ MHz}$ Offset. | | | | | |
| Power Gain | G_{ps} | 14.2 | 15.4 | 16.2 | dB |
| Drain Efficiency | η_D | 44.0 | 47.0 | — | % |
| P_{out} @ 3 dB Compression Point, CW | P3dB | 55.0 | 55.9 | — | dBm |
| Adjacent Channel Power Ratio | ACPR | — | -35.2 | -30.9 | dBc |

Load Mismatch ⁽³⁾ (In NXP Doherty Production Test Fixture, 50 ohm system) $I_{DQA} = 600\text{ mA}$, $V_{GSB} = 0.5\text{ Vdc}$, $f = 2155\text{ MHz}$, 12 μsec (on), 10% Duty Cycle

| | |
|--|-----------------------|
| VSWR 10:1 at 32 Vdc, 400 W Pulsed CW Output Power (3 dB Input Overdrive from 251 W Pulsed CW Rated Power) | No Device Degradation |
|--|-----------------------|

Typical Performance ⁽³⁾ (In NXP Doherty Characterization Test Fixture, 50 ohm system) $V_{DD} = 30\text{ Vdc}$, $I_{DQA} = 600\text{ mA}$, $V_{GSB} = 0.5\text{ Vdc}$, 2110–2200 MHz Bandwidth

| | | | | | |
|--|------------------|---|-------|---|-------|
| P_{out} @ 3 dB Compression Point ⁽⁴⁾ | P3dB | — | 501 | — | W |
| AM/PM (Maximum value measured at the P3dB compression point across the 2110–2200 MHz bandwidth) | Φ | — | -19 | — | ° |
| VBW Resonance Point (IMD Third Order Intermodulation Inflection Point) | VBW_{res} | — | 180 | — | MHz |
| Gain Flatness in 90 MHz Bandwidth @ $P_{out} = 87\text{ W Avg.}$ | G_F | — | 0.7 | — | dB |
| Gain Variation over Temperature (-30°C to +85°C) | ΔG | — | 0.007 | — | dB/°C |
| Output Power Variation over Temperature (-30°C to +85°C) | ΔP_{1dB} | — | 0.007 | — | dB/°C |

Table 5. Ordering Information

| Device | Tape and Reel Information | Package |
|-----------------|---|----------------|
| A3T21H450W23SR6 | R6 Suffix = 150 Units, 56 mm Tape Width, 13-inch Reel | ACP-1230S-4L2S |

- V_{DDA} and V_{DDB} must be tied together and powered by a single DC power supply.
- Part internally matched both on input and output.
- Measurements made with device in an asymmetrical Doherty configuration.
- $P_{3dB} = P_{avg} + 7.0\text{ dB}$ where P_{avg} is the average output power measured using an unclipped W-CDMA single-carrier input signal where output PAR is compressed to 7.0 dB @ 0.01% probability on CCDF.

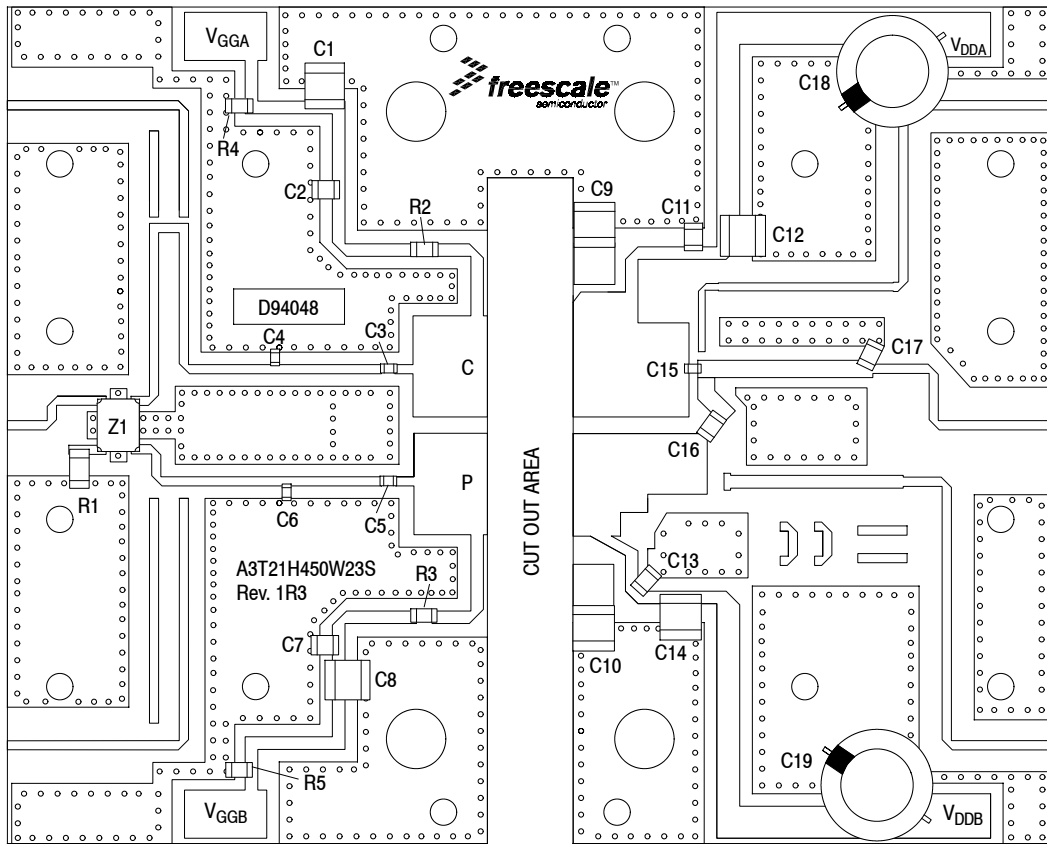

Note: V_{DDA} and V_{ddb} must be tied together and powered by a single DC power supply.

Figure 2. A3T21H450W23SR6 Characterization Test Circuit Component Layout

Table 6. A3T21H450W23SR6 Characterization Test Circuit Component Designations and Values

| Part | Description | Part Number | Manufacturer |
|---------------------------|---|----------------------|--------------|
| C1, C8, C9, C10, C12, C14 | 10 μ F Chip Capacitor | C5750X7S2A106M230KB | TDK |
| C2, C7, C11, C13 | 9.1 pF Chip Capacitor | ATC100B9R1CT500XT | ATC |
| C3, C5 | 9.1 pF Chip Capacitor | ATC600F9R1BT250XT | ATC |
| C4 | 1 pF Chip Capacitor | ATC100B1R0CT500XT | ATC |
| C6 | 0.4 pF Chip Capacitor | ATC100B0R4CT500XT | ATC |
| C15 | 5.1 pF Chip Capacitor | ATC600F5R1BT250XT | ATC |
| C16 | 15 pF Chip Capacitor | ATC100B150JT500XT | ATC |
| C17 | 0.2 pF Chip Capacitor | ATC100B0R2BT500XT | ATC |
| C18, C19 | 470 μ F, 63 V Electrolytic Capacitor | MCGPR63V477M13X26-RH | Multicomp |
| R1 | 50 Ω , 10 W Chip Resistor | C10A50Z4 | Anaren |
| R2, R3 | 3.9 Ω , 1/4 W Chip Resistor | CRCW12063R90FKEA | Vishay |
| R4, R5 | 1.8 k Ω , 1/4 W Chip Resistor | CRCW12061K80FKEA | Vishay |
| Z1 | 2000–2300 MHz Band, 90°, 5 dB Directional Coupler | X3C21P1-05S | Anaren |
| PCB | Rogers RO4350B, 0.020", $\epsilon_r = 3.66$ | D94048 | MTL |

TYPICAL CHARACTERISTICS — 2110–2200 MHz

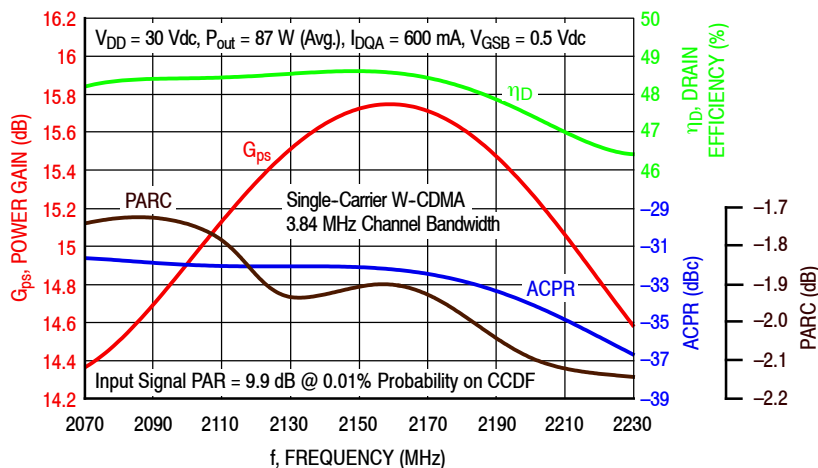

Figure 3. Single-Carrier Output Peak-to-Average Ratio Compression (PARC) Broadband Performance @ P_{out} = 87 Watts Avg.

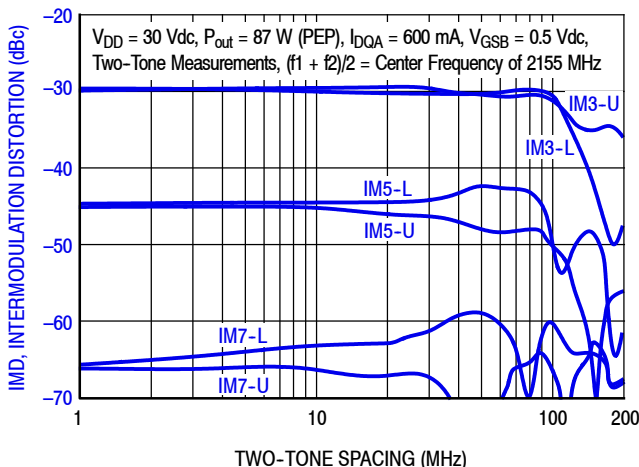

Figure 4. Intermodulation Distortion Products versus Two-Tone Spacing

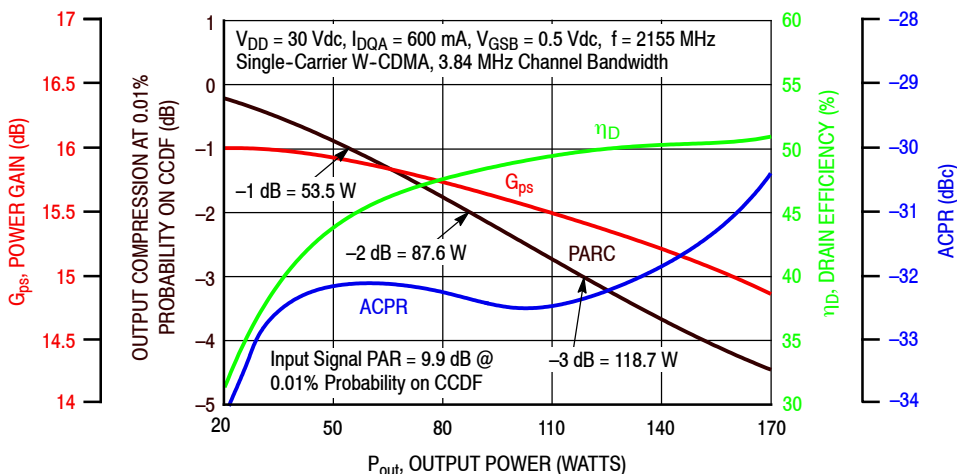

Figure 5. Output Peak-to-Average Ratio Compression (PARC) versus Output Power

TYPICAL CHARACTERISTICS — 2110–2200 MHz

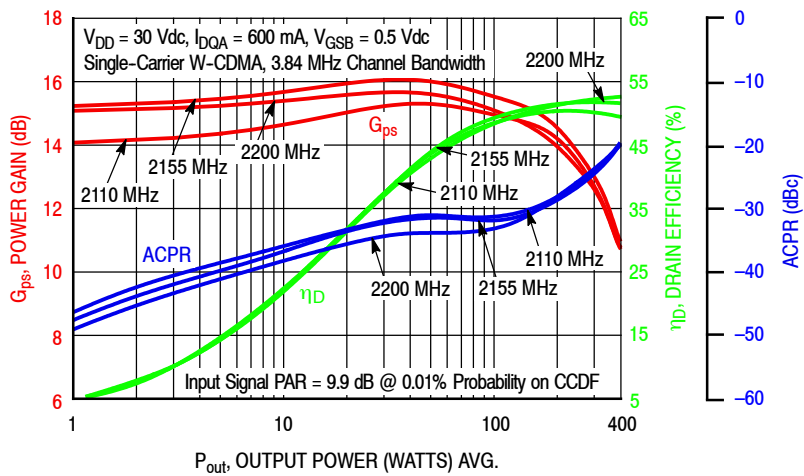

Figure 6. Single-Carrier W-CDMA Power Gain, Drain Efficiency and ACPR versus Output Power

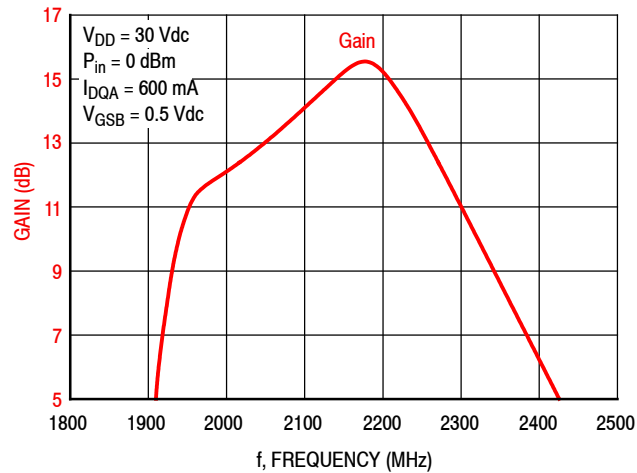

Figure 7. Broadband Frequency Response

Table 7. Carrier Side Load Pull Performance — Maximum Power Tuning

V_{DD} = 30 Vdc, I_{DQA} = 804 mA, Pulsed CW, 10 μsec(on), 10% Duty Cycle

| f (MHz) | Z _{source} (Ω) | Z _{in} (Ω) | Max Output Power | | | | | |
|---------|-------------------------|---------------------|--------------------------------------|-----------|-------|-----|--------------------|-----------|
| | | | P1dB | | | | | |
| | | | Z _{load} ⁽¹⁾ (Ω) | Gain (dB) | (dBm) | (W) | η _D (%) | AM/PM (°) |
| 2110 | 2.26 – j6.69 | 2.28 + j6.33 | 1.26 – j4.31 | 18.2 | 53.5 | 224 | 58.7 | -14 |
| 2140 | 2.79 – j7.42 | 2.93 + j7.10 | 1.32 – j4.37 | 18.3 | 53.4 | 218 | 58.1 | -15 |
| 2170 | 4.03 – j8.18 | 3.88 + j7.96 | 1.29 – j4.36 | 18.3 | 53.3 | 216 | 57.9 | -14 |
| 2200 | 5.37 – j9.47 | 5.43 + j8.78 | 1.32 – j4.37 | 18.3 | 53.3 | 213 | 56.4 | -15 |

| f (MHz) | Z _{source} (Ω) | Z _{in} (Ω) | Max Output Power | | | | | |
|---------|-------------------------|---------------------|--------------------------------------|-----------|-------|-----|--------------------|-----------|
| | | | P3dB | | | | | |
| | | | Z _{load} ⁽²⁾ (Ω) | Gain (dB) | (dBm) | (W) | η _D (%) | AM/PM (°) |
| 2110 | 2.26 – j6.69 | 2.20 + j6.63 | 1.24 – j4.55 | 15.9 | 54.2 | 263 | 59.3 | -19 |
| 2140 | 2.79 – j7.42 | 2.87 + j7.50 | 1.30 – j4.58 | 16.1 | 54.1 | 257 | 59.0 | -19 |
| 2170 | 4.03 – j8.18 | 3.90 + j8.49 | 1.31 – j4.57 | 16.1 | 54.1 | 256 | 58.7 | -18 |
| 2200 | 5.37 – j9.47 | 5.62 + j9.53 | 1.31 – j4.54 | 16.0 | 54.0 | 253 | 57.6 | -19 |

(1) Load impedance for optimum P1dB power.

(2) Load impedance for optimum P3dB power.

Z_{source} = Measured impedance presented to the input of the device at the package reference plane.

Z_{in} = Impedance as measured from gate contact to ground.

Z_{load} = Measured impedance presented to the output of the device at the package reference plane.

Table 8. Carrier Side Load Pull Performance — Maximum Efficiency Tuning

V_{DD} = 30 Vdc, I_{DQA} = 804 mA, Pulsed CW, 10 μsec(on), 10% Duty Cycle

| f (MHz) | Z _{source} (Ω) | Z _{in} (Ω) | Max Drain Efficiency | | | | | |
|---------|-------------------------|---------------------|--------------------------------------|-----------|-------|-----|--------------------|-----------|
| | | | P1dB | | | | | |
| | | | Z _{load} ⁽¹⁾ (Ω) | Gain (dB) | (dBm) | (W) | η _D (%) | AM/PM (°) |
| 2110 | 2.26 – j6.69 | 2.33 + j6.54 | 2.68 – j3.37 | 20.7 | 51.7 | 148 | 69.2 | -20 |
| 2140 | 2.79 – j7.42 | 3.03 + j7.31 | 2.73 – j3.29 | 20.9 | 51.4 | 138 | 67.3 | -20 |
| 2170 | 4.03 – j8.18 | 3.98 + j8.13 | 2.24 – j3.62 | 20.3 | 52.1 | 163 | 67.2 | -18 |
| 2200 | 5.37 – j9.47 | 5.53 + j9.11 | 2.19 – j3.17 | 20.7 | 51.6 | 144 | 65.5 | -19 |

| f (MHz) | Z _{source} (Ω) | Z _{in} (Ω) | Max Drain Efficiency | | | | | |
|---------|-------------------------|---------------------|--------------------------------------|-----------|-------|-----|--------------------|-----------|
| | | | P3dB | | | | | |
| | | | Z _{load} ⁽²⁾ (Ω) | Gain (dB) | (dBm) | (W) | η _D (%) | AM/PM (°) |
| 2110 | 2.26 – j6.69 | 2.25 + j6.72 | 2.63 – j3.88 | 18.3 | 52.7 | 187 | 68.7 | -24 |
| 2140 | 2.79 – j7.42 | 3.04 + j7.57 | 2.84 – j3.95 | 18.3 | 52.5 | 177 | 66.4 | -22 |
| 2170 | 4.03 – j8.18 | 4.05 + j8.54 | 2.49 – j4.00 | 18.1 | 52.9 | 193 | 66.8 | -21 |
| 2200 | 5.37 – j9.47 | 5.86 + j9.55 | 2.54 – j3.69 | 18.3 | 52.6 | 184 | 66.3 | -23 |

(1) Load impedance for optimum P1dB efficiency.

(2) Load impedance for optimum P3dB efficiency.

Z_{source} = Measured impedance presented to the input of the device at the package reference plane.

Z_{in} = Impedance as measured from gate contact to ground.

Z_{load} = Measured impedance presented to the output of the device at the package reference plane.

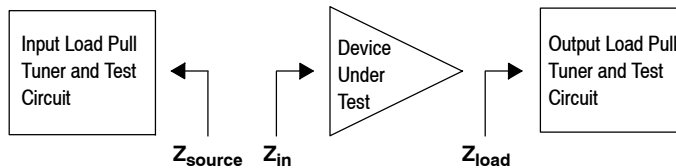

Table 9. Peaking Side Load Pull Performance — Maximum Power Tuning

$V_{DD} = 30$ Vdc, $V_{GSB} = 1.8$ Vdc, Pulsed CW, 10 μ sec(on), 10% Duty Cycle

| f (MHz) | Z_{source} (Ω) | Z_{in} (Ω) | Max Output Power | | | | | |
|---------|---------------------------|-----------------------|-------------------------------|-----------|-------|-----|--------------|--------------------|
| | | | P1dB | | | | | |
| | | | $Z_{load}^{(1)}$ (Ω) | Gain (dB) | (dBm) | (W) | η_D (%) | AM/PM ($^\circ$) |
| 2110 | 2.11 - j7.12 | 1.48 + j6.12 | 3.76 - j4.75 | 17.7 | 56.1 | 405 | 54.5 | -15 |
| 2140 | 2.61 - j7.79 | 1.78 + j6.77 | 4.05 - j4.63 | 18.1 | 56.0 | 399 | 54.4 | -15 |
| 2170 | 3.53 - j8.88 | 2.25 + j7.54 | 4.56 - j4.43 | 18.2 | 56.0 | 395 | 54.3 | -16 |
| 2200 | 4.62 - j10.2 | 2.97 + j8.37 | 4.94 - j4.19 | 18.3 | 55.9 | 388 | 53.6 | -17 |

| f (MHz) | Z_{source} (Ω) | Z_{in} (Ω) | Max Output Power | | | | | |
|---------|---------------------------|-----------------------|-------------------------------|-----------|-------|-----|--------------|--------------------|
| | | | P3dB | | | | | |
| | | | $Z_{load}^{(2)}$ (Ω) | Gain (dB) | (dBm) | (W) | η_D (%) | AM/PM ($^\circ$) |
| 2110 | 2.11 - j7.12 | 1.48 + j6.40 | 4.35 - j5.05 | 15.6 | 56.6 | 460 | 54.9 | -20 |
| 2140 | 2.61 - j7.79 | 1.82 + j7.12 | 4.95 - j4.79 | 16.0 | 56.6 | 453 | 54.5 | -21 |
| 2170 | 3.53 - j8.88 | 2.35 + j7.96 | 5.17 - j4.46 | 16.1 | 56.5 | 449 | 54.6 | -22 |
| 2200 | 4.62 - j10.2 | 3.21 + j8.90 | 5.69 - j4.11 | 16.1 | 56.4 | 440 | 53.7 | -23 |

(1) Load impedance for optimum P1dB power.

(2) Load impedance for optimum P3dB power.

Z_{source} = Measured impedance presented to the input of the device at the package reference plane.

Z_{in} = Impedance as measured from gate contact to ground.

Z_{load} = Measured impedance presented to the output of the device at the package reference plane.

Table 10. Peaking Side Load Pull Performance — Maximum Efficiency Tuning

$V_{DD} = 30$ Vdc, $V_{GSB} = 1.8$ Vdc, Pulsed CW, 10 μ sec(on), 10% Duty Cycle

| f (MHz) | Z_{source} (Ω) | Z_{in} (Ω) | Max Drain Efficiency | | | | | |
|---------|---------------------------|-----------------------|-------------------------------|-----------|-------|-----|--------------|--------------------|
| | | | P1dB | | | | | |
| | | | $Z_{load}^{(1)}$ (Ω) | Gain (dB) | (dBm) | (W) | η_D (%) | AM/PM ($^\circ$) |
| 2110 | 2.11 - j7.12 | 1.30 + j6.07 | 3.28 - j2.25 | 19.4 | 55.1 | 323 | 61.4 | -21 |
| 2140 | 2.61 - j7.79 | 1.55 + j6.69 | 2.94 - j2.24 | 19.8 | 54.9 | 312 | 61.8 | -23 |
| 2170 | 3.53 - j8.88 | 1.92 + j7.43 | 2.66 - j1.97 | 20.1 | 54.6 | 288 | 62.3 | -25 |
| 2200 | 4.62 - j10.2 | 2.55 + j8.26 | 2.72 - j2.01 | 20.1 | 54.6 | 291 | 61.8 | -26 |

| f (MHz) | Z_{source} (Ω) | Z_{in} (Ω) | Max Drain Efficiency | | | | | |
|---------|---------------------------|-----------------------|-------------------------------|-----------|-------|-----|--------------|--------------------|
| | | | P3dB | | | | | |
| | | | $Z_{load}^{(2)}$ (Ω) | Gain (dB) | (dBm) | (W) | η_D (%) | AM/PM ($^\circ$) |
| 2110 | 2.11 - j7.12 | 1.33 + j6.35 | 3.83 - j2.30 | 17.3 | 55.8 | 377 | 59.4 | -27 |
| 2140 | 2.61 - j7.79 | 1.64 + j7.05 | 3.63 - j2.16 | 17.7 | 55.7 | 372 | 59.7 | -28 |
| 2170 | 3.53 - j8.88 | 2.09 + j7.87 | 3.22 - j1.97 | 17.9 | 55.5 | 353 | 59.9 | -30 |
| 2200 | 4.62 - j10.2 | 2.85 + j8.81 | 3.24 - j1.95 | 17.9 | 55.5 | 352 | 59.7 | -31 |

(1) Load impedance for optimum P1dB efficiency.

(2) Load impedance for optimum P3dB efficiency.

Z_{source} = Measured impedance presented to the input of the device at the package reference plane.

Z_{in} = Impedance as measured from gate contact to ground.

Z_{load} = Measured impedance presented to the output of the device at the package reference plane.

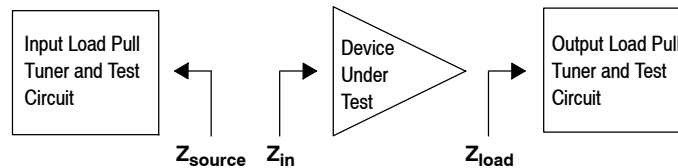

A3T21H450W23SR6

P1dB – TYPICAL CARRIER SIDE LOAD PULL CONTOURS — 2140 MHz

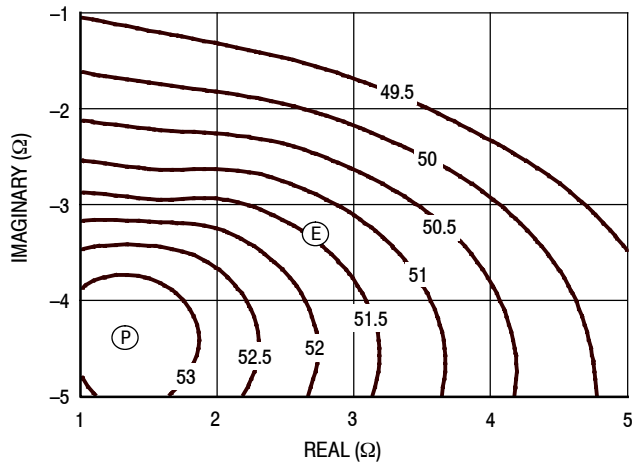

Figure 8. P1dB Load Pull Output Power Contours (dBm)

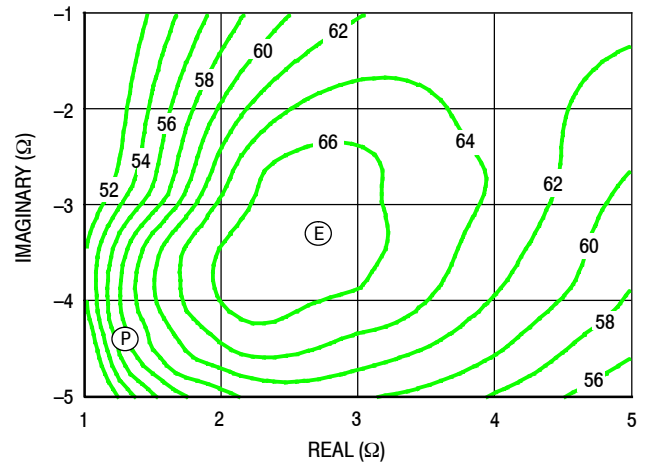

Figure 9. P1dB Load Pull Efficiency Contours (%)

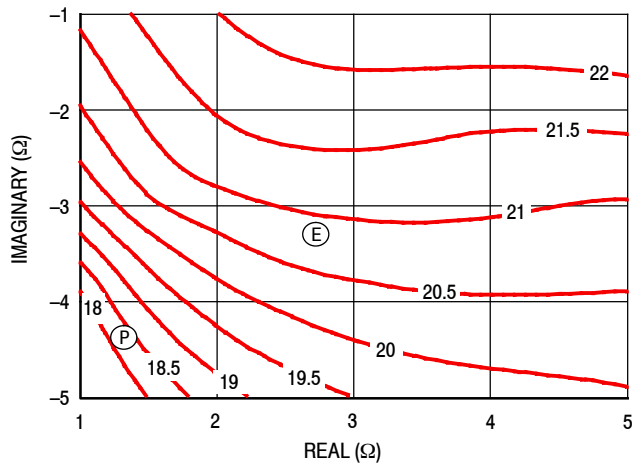

Figure 10. P1dB Load Pull Gain Contours (dB)

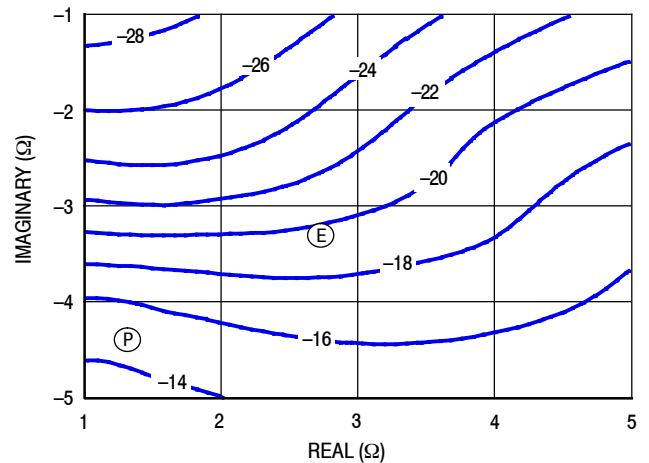

Figure 11. P1dB Load Pull AM/PM Contours (°)

NOTE: (P) = Maximum Output Power
(E) = Maximum Drain Efficiency

- Gain
- Drain Efficiency
- Linearity
- Output Power

P3dB – TYPICAL CARRIER SIDE LOAD PULL CONTOURS — 2140 MHz

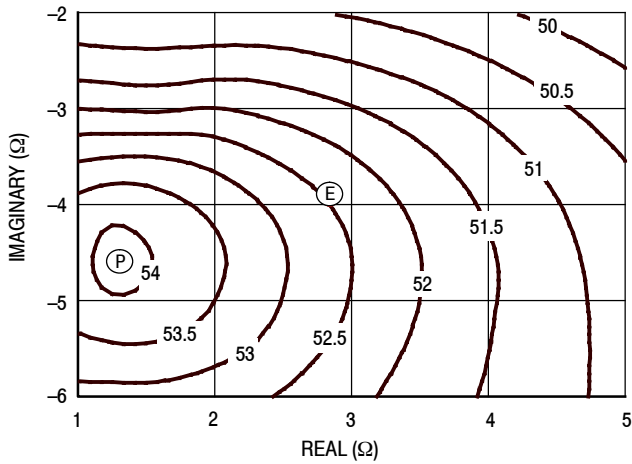

Figure 12. P3dB Load Pull Output Power Contours (dBm)

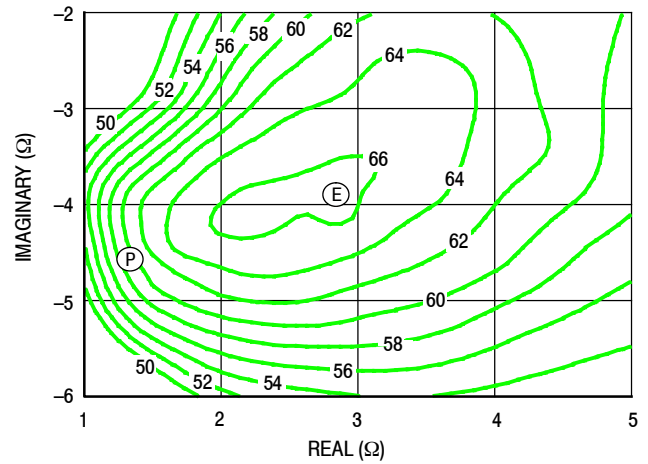

Figure 13. P3dB Load Pull Efficiency Contours (%)

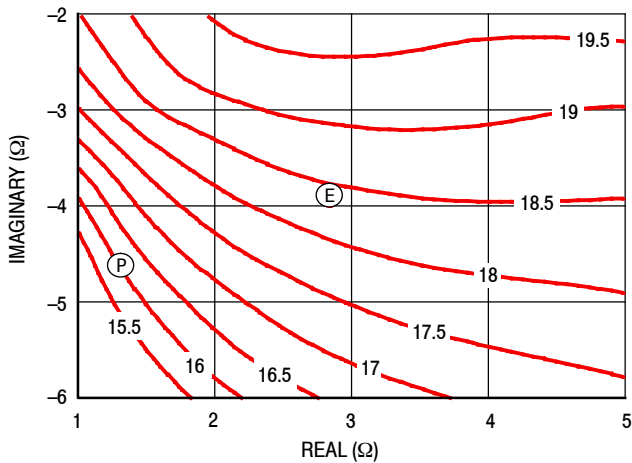

Figure 14. P3dB Load Pull Gain Contours (dB)

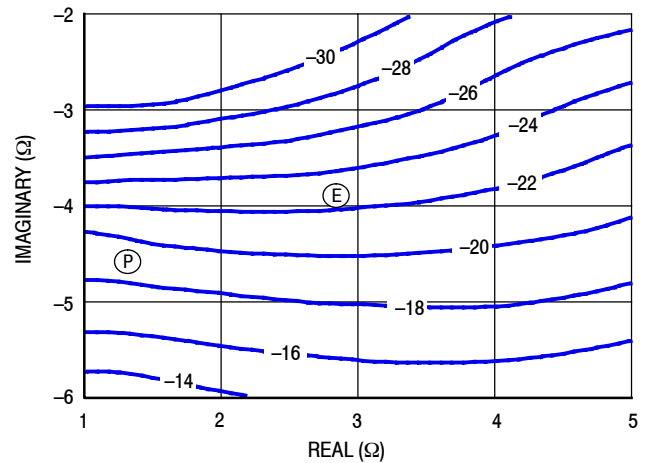

Figure 15. P3dB Load Pull AM/PM Contours (°)

NOTE: (P) = Maximum Output Power
(E) = Maximum Drain Efficiency

- Gain
- Drain Efficiency
- Linearity
- Output Power

P1dB – TYPICAL PEAKING SIDE LOAD PULL CONTOURS — 2140 MHz

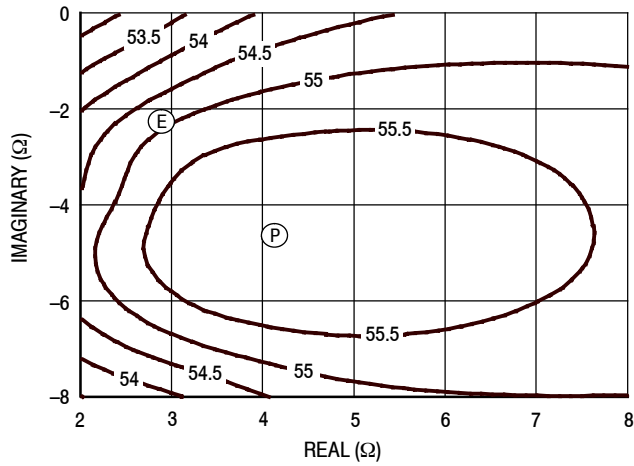

Figure 16. P1dB Load Pull Output Power Contours (dBm)

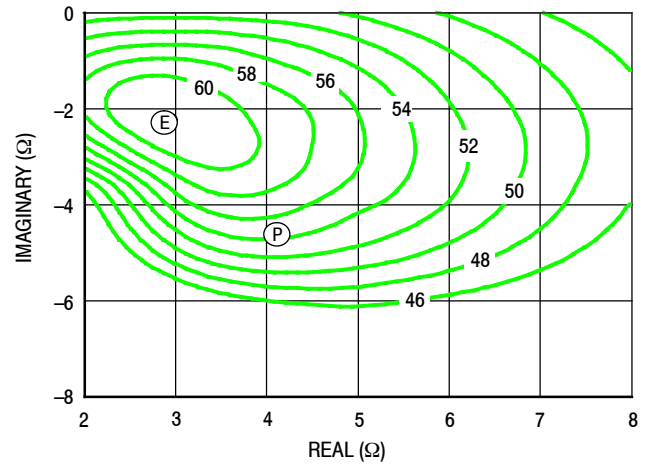

Figure 17. P1dB Load Pull Efficiency Contours (%)

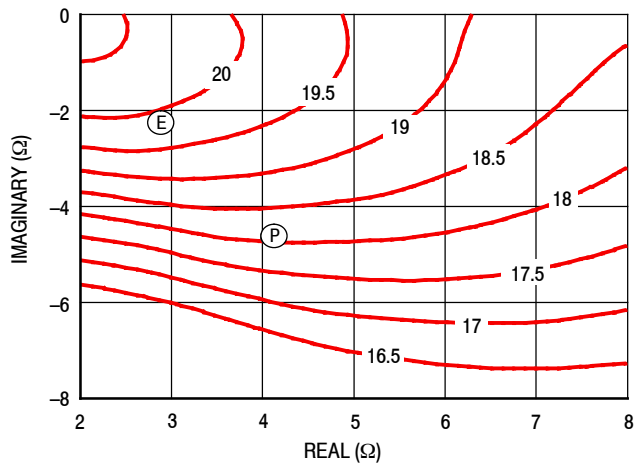

Figure 18. P1dB Load Pull Gain Contours (dB)

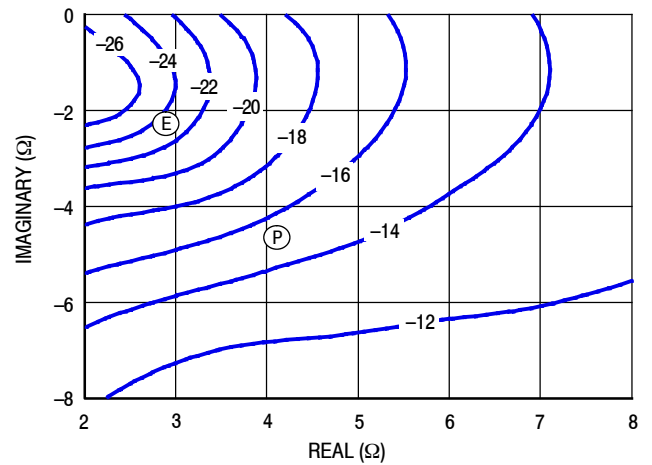

Figure 19. P1dB Load Pull AM/PM Contours (°)

NOTE: (P) = Maximum Output Power

(E) = Maximum Drain Efficiency

- Gain
- Drain Efficiency
- Linearity
- Output Power

P3dB – TYPICAL PEAKING SIDE LOAD PULL CONTOURS — 2140 MHz

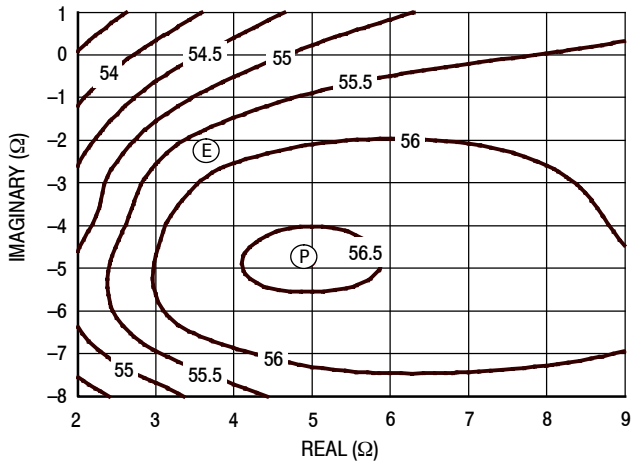

Figure 20. P3dB Load Pull Output Power Contours (dBm)

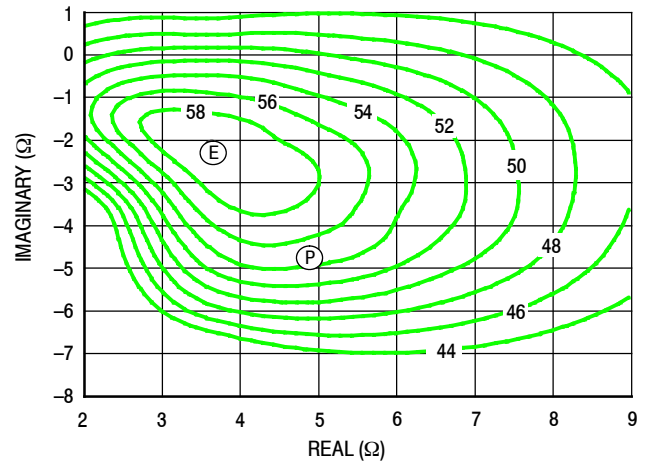

Figure 21. P3dB Load Pull Efficiency Contours (%)

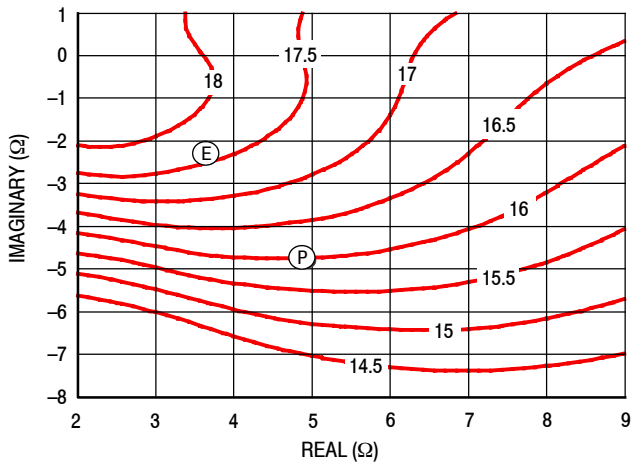

Figure 22. P3dB Load Pull Gain Contours (dB)

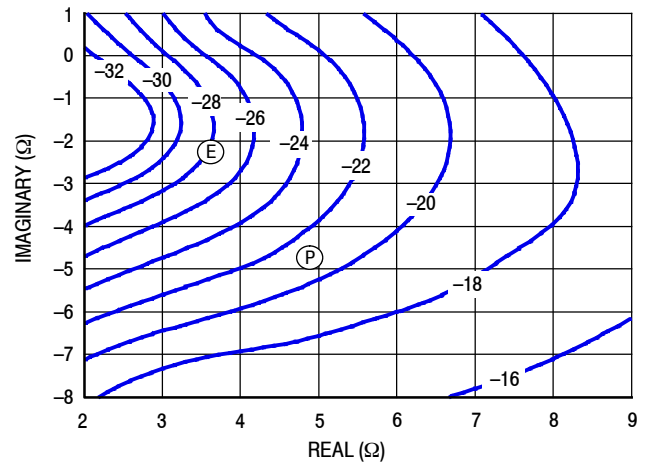
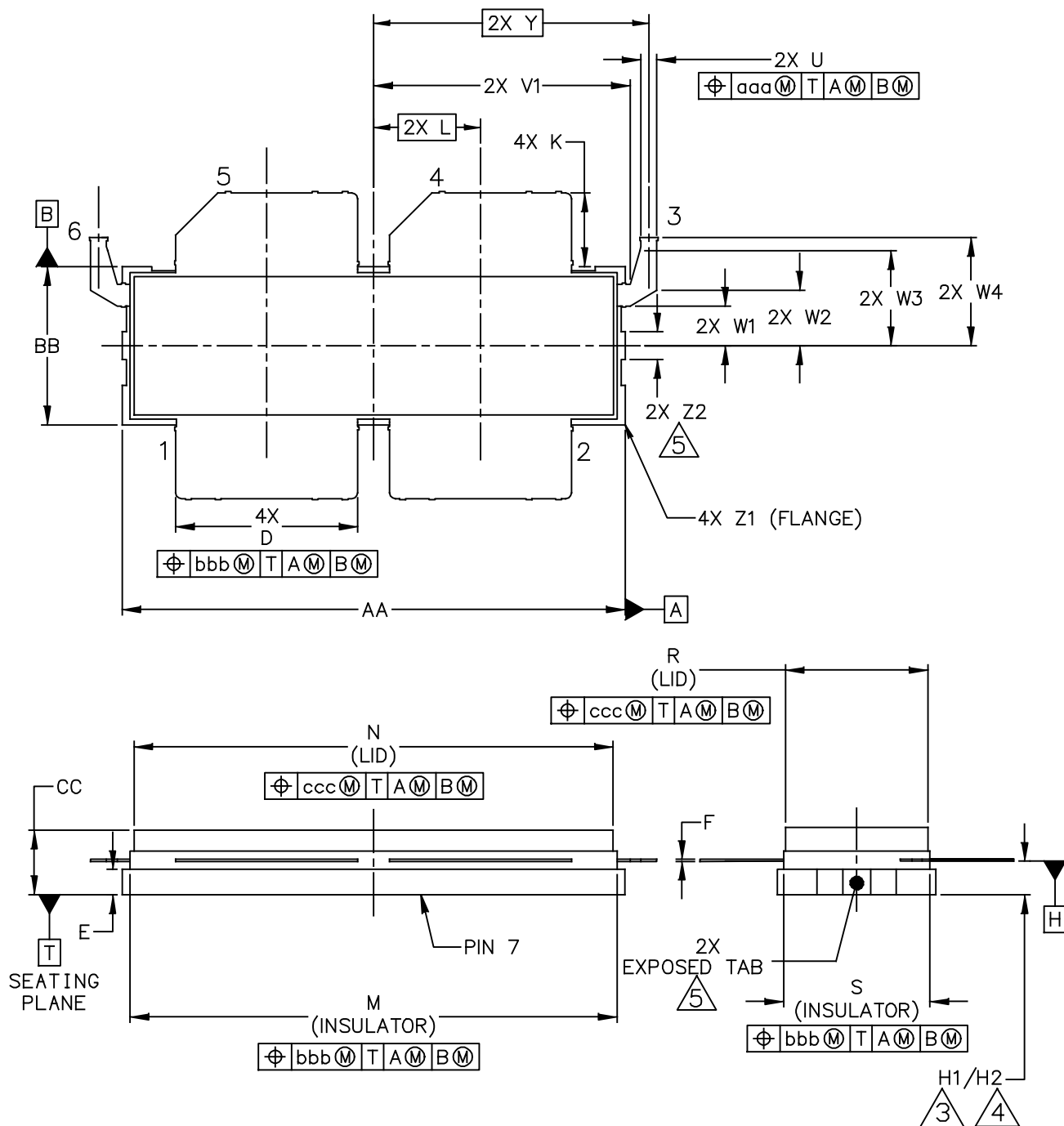

Figure 23. P3dB Load Pull AM/PM Contours (°)

NOTE: (P) = Maximum Output Power
(E) = Maximum Drain Efficiency

- Gain
- Drain Efficiency
- Linearity
- Output Power

PACKAGE DIMENSIONS



| | | |
|---|--------------------------|----------------------------|
| © NXP SEMICONDUCTORS N. V. ALL RIGHTS RESERVED | MECHANICAL OUTLINE | PRINT VERSION NOT TO SCALE |
| TITLE: ACP-1230S-4L2S | DOCUMENT NO: 98ASA00974D | REV: A |
| | STANDARD: NON-JEDEC | |
| | SOT1800-4 | 21 JUN 2017 |

A3T21H450W23SR6

NOTES:

1. INTERPRET DIMENSIONS AND TOLERANCES PER ASME Y14.5M-1994.

2. CONTROLLING DIMENSION: INCH

3. DIMENSIONS H1 AND H2 ARE MEASURED .030 INCH (0.762 MM) AWAY FROM FLANGE PARALLEL TO DATUM B. H1 APPLIES TO PINS 1, 2, 4 & 5. H2 APPLIES TO PINS 3 & 6.

4. TOLERANCE OF DIMENSION H2 IS TENTATIVE.

5. THESE SURFACES OF THE HEAT SLUG ARE NOT PART OF THE SOLDERABLE SURFACES AND MAY REMAIN UNPLATED.

6. DATUM H IS LOCATED AT THE BOTTOM OF THE LEAD FRAME AND IS COINCIDENT WITH THE LEAD WHERE THE LEADS EXIT THE PLASTIC BODY.

7. DIMENSIONS M AND S DO NOT INCLUDE MOLD PROTRUSION. ALLOWABLE PROTRUSION IS .012 INCH (0.30 MM) PER SIDE. DIMENSIONS M AND S DO INCLUDE MOLD MISMATCH AND ARE DETERMINED AT DATUM PLANE H.

8. DIMENSIONS D, U AND K DO NOT INCLUDE DAMBAR PROTRUSION. ALLOWABLE DAMBAR PROTRUSION SHALL BE .010 INCH (0.25 MM) TOTAL IN EXCESS OF THE D, U AND K DIMENSION AT MAXIMUM MATERIAL CONDITION.

9. DATUM A AND B TO BE DETERMINED AT DATUM T.

| DIM | INCHES | | MILLIMETERS | | DIM | INCHES | | MILLIMETERS | |
|-----|-----------|-------|-------------|-------|-----|-----------|-------|-------------|-------|
| | MIN | MAX | MIN | MAX | | MIN | MAX | MIN | MAX |
| AA | 1.265 | 1.275 | 32.13 | 32.39 | S | .365 | .375 | 9.27 | 9.53 |
| BB | .395 | .405 | 10.03 | 10.29 | U | .035 | .045 | 0.89 | 1.14 |
| CC | .160 | .190 | 4.06 | 4.83 | V1 | .640 | .655 | 16.26 | 16.64 |
| D | .455 | .465 | 11.56 | 11.81 | W1 | .105 | .115 | 2.67 | 2.92 |
| E | .062 | .069 | 1.57 | 1.75 | W2 | .135 | .145 | 3.43 | 3.68 |
| F | .004 | .007 | 0.10 | 0.18 | W3 | .245 | .255 | 6.22 | 6.48 |
| H1 | .082 | .090 | 2.08 | 2.29 | W4 | .265 | .281 | 6.73 | 7.14 |
| H2 | .078 | .094 | 1.98 | 2.39 | Y | 0.695 BSC | | 17.65 BSC | |
| K | .175 | .195 | 4.45 | 4.95 | Z1 | R.000 | R.040 | R0.00 | R1.02 |
| L | 0.270 BSC | | 6.86 BSC | | Z2 | .060 | .100 | 1.52 | 2.54 |
| M | 1.219 | 1.241 | 30.96 | 31.52 | aaa | .015 | | 0.38 | |
| N | 1.218 | 1.242 | 30.94 | 31.55 | bbb | .010 | | 0.25 | |
| R | .365 | .375 | 9.27 | 9.53 | ccc | .020 | | 0.51 | |

© NXP SEMICONDUCTORS N.V.
ALL RIGHTS RESERVED

MECHANICAL OUTLINE

PRINT VERSION NOT TO SCALE

TITLE:

ACP-1230S-4L2S

DOCUMENT NO: 98ASA00974D

REV: A

STANDARD: NON-JEDEC

SOT1800-4

21 JUN 2017

PRODUCT DOCUMENTATION, SOFTWARE AND TOOLS

Refer to the following resources to aid your design process.

Application Notes

- AN1908: Solder Reflow Attach Method for High Power RF Devices in Air Cavity Packages
- AN1955: Thermal Measurement Methodology of RF Power Amplifiers

Engineering Bulletins

- EB212: Using Data Sheet Impedances for RF LDMOS Devices

Software

- Electromigration MTTF Calculator
- .s2p File

Development Tools

- Printed Circuit Boards

To Download Resources Specific to a Given Part Number:

1. Go to <http://www.nxp.com/RF>
2. Search by part number
3. Click part number link
4. Choose the desired resource from the drop down menu

REVISION HISTORY

The following table summarizes revisions to this document.

| Revision | Date | Description |
|----------|-----------|---|
| 0 | July 2017 | • Initial release of data sheet |
| 1 | Aug. 2017 | • Typical Characteristic 2110–2200 MHz performance graphs: added Figs. 3–7, pp. 5–6 |

How to Reach Us:

Home Page:
nxp.com

Web Support:
nxp.com/support

Information in this document is provided solely to enable system and software implementers to use NXP products. There are no express or implied copyright licenses granted hereunder to design or fabricate any integrated circuits based on the information in this document. NXP reserves the right to make changes without further notice to any products herein.

NXP makes no warranty, representation, or guarantee regarding the suitability of its products for any particular purpose, nor does NXP assume any liability arising out of the application or use of any product or circuit, and specifically disclaims any and all liability, including without limitation consequential or incidental damages. "Typical" parameters that may be provided in NXP data sheets and/or specifications can and do vary in different applications, and actual performance may vary over time. All operating parameters, including "typicals," must be validated for each customer application by customer's technical experts. NXP does not convey any license under its patent rights nor the rights of others. NXP sells products pursuant to standard terms and conditions of sale, which can be found at the following address: nxp.com/SalesTermsandConditions.

NXP, the NXP logo, Freescale, the Freescale logo, and Airfast are trademarks of NXP B.V. All other product or service names are the property of their respective owners.
© 2017 NXP B.V.

