

SEALED SWITCH MODULE

TC
SWITCH
MODULE

SELF-CONTAINED, LONG-LIFE, SEALED SWITCH MODULE WITH UP TO 5 POSITIONS

The TC is a self contained, sealed switch module with up to 5 positions. It can be utilized in numerous applications that require a compact switch module and long life.

At slightly over an inch in diameter, it can be used in a grip, front panel, or hand held device, just to name a few applications. It is available in either a top mount or rear mount.

The advantage of the TC switch module is that it incorporates keypad functionality within a very small footprint. Standard or custom legends are available and can be LED backlit.

Standard termination options include flying leads, ribbon cable (with or without AMP connector) and FFC (flexible flat cable). Tested to three million cycles, the TC switch module has an operating temperature range of -40°C to 85°C and it is sealed to IP68S.

The TC can be used in panel or grip applications and is especially useful in cursor control or data entry applications. Applications include construction, agriculture, industrial, material handling and medical.

Features:

- **Watertight to IP68S**
- **Great for grips and panels**
- **LED backlight option**
- **3 million cycle electrical life**



TC Standard Characteristics/Ratings:	
ELECTRICAL RATINGS:	1-28VDC @ Sea Level
Load:	10-100mA Resistive
Electrical Life:	3,000,000 cycles
Mechanical Life:	3,000,000 cycles
Seal:	IP68S
Operating Temp Range:	-40°C to +85°C
Operating Force:	1.0 +/- .5 lbs.
Pushout Force:	5 lbs. min.
MATERIALS:	
Housing:	PBT
Keypad:	Silicone Rubber
Terminal Hardware:	None provided
Mounting Hardware:	VHB tape

TC Switch Module Keypad Configurations

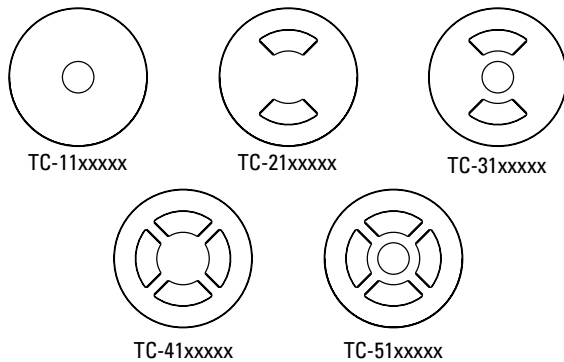

TC-5 with standard legend used in a Contour Grip

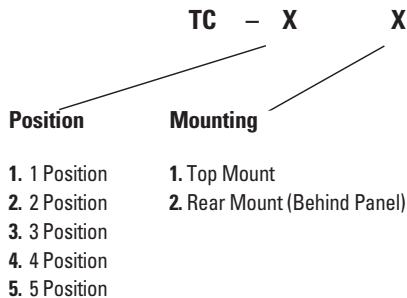

TC PART NUMBER CODE

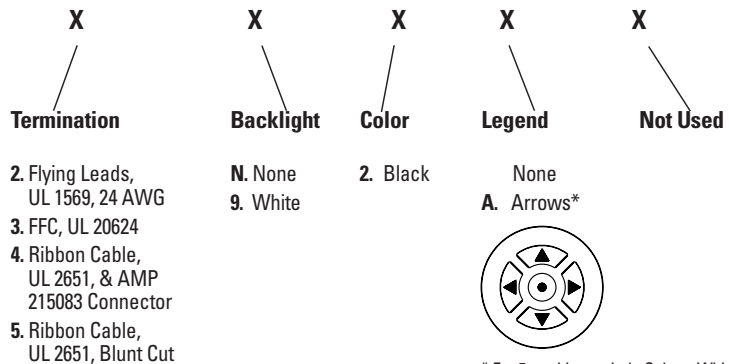

* For 5-position switch, Color = White

SELF-CONTAINED, LONG-LIFE, SEALED SWITCH MODULE WITH UP TO 5 POSITIONS

TC-51xxxxx
Top Mount, 5 Position Module

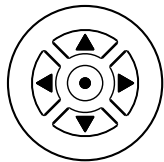
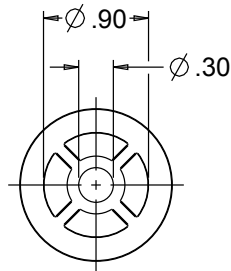

Standard legend configuration

Rear Mount

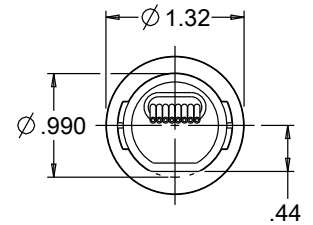
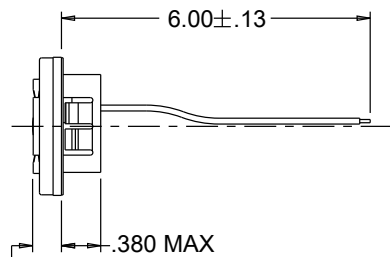
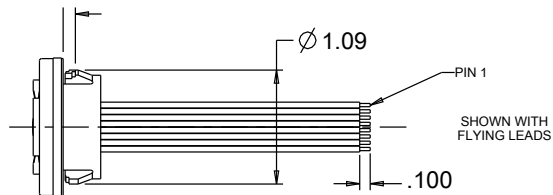
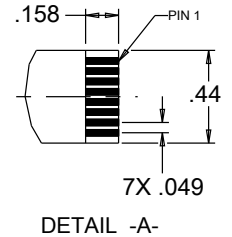
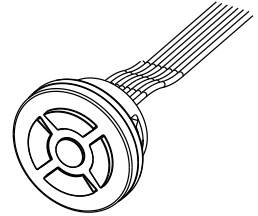
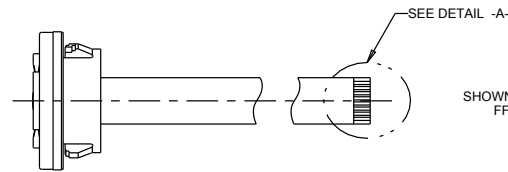
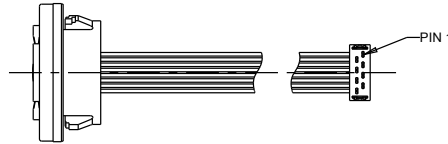
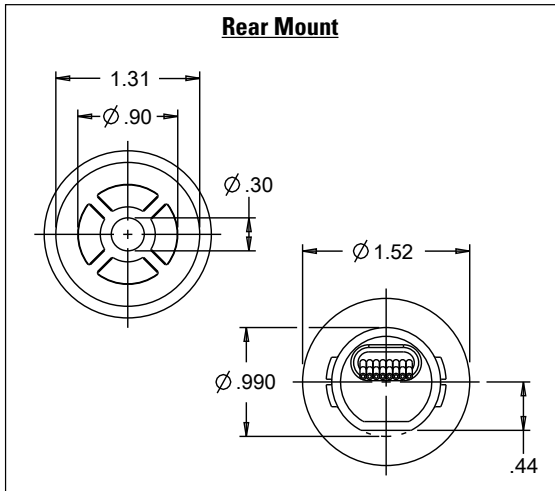

.300 MAX

TC Switch Module Keypad Configurations

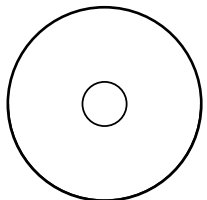

TC-11xxxxx

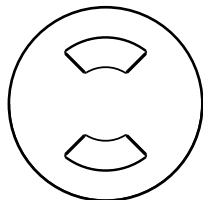

TC-21xxxxx

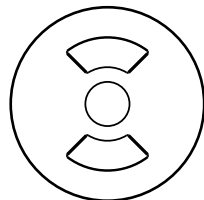

TC-31xxxxx

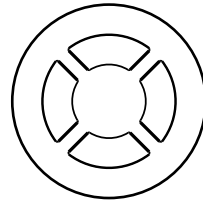

TC-41xxxxx

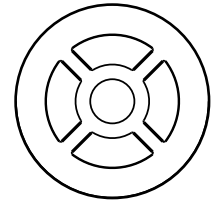

TC-51xxxxx