

DATA SHEET

SKY67023-396LF: 2.0 to 3.0 GHz High Linearity, Active Bias Low-Noise Amplifier

Applications

- CDMA, WCDMA, TD-SCDMA, WiMAX, LTE cellular infrastructure
- Ultra low-noise systems
- Balanced, single-ended low-noise amplifier designs

Features

- Extended operating temperature range: -40 °C to +100 °C
- Low Noise Figure: 0.89 dB @ 2.6 GHz
- Excellent IIP3 performance: +22 dBm @ 2.6 GHz
- Gain: 17.3 dB @ 2.6 GHz
- Adjustable supply current
- Integrated enable circuitry
- Temperature and process-stable active bias
- Miniature DFN (8-pin, 2 x 2 mm) package (MSL1 @ 260 °C per JEDEC J-STD-020)



Skyworks Green™ products are compliant with all applicable legislation and are halogen-free. For additional information, refer to *Skyworks Definition of Green™*, document number SQ04-0074.

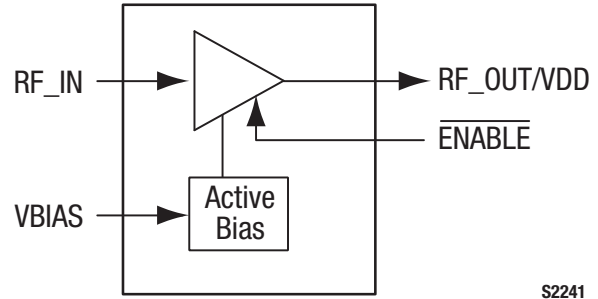

Figure 1. SKY67023-396LF Block Diagram

Description

The SKY67023-396LF is GaAs, pHEMT low-noise amplifier (LNA) with an active bias and high-linearity performance. The advanced GaAs pHEMT enhancement mode process provides good return loss, low noise, and high-linearity performance.

The internal active bias circuitry provides stable performance over temperature and process variation. The device offers the ability to externally adjust supply current and gain. Supply voltage is applied to the RFOUT/VDD pin through an RF choke inductor. Pin 3 (VBIAS) should be connected to RFOUT/VDD through an external resistor to control the supply current. The RFIN and RFOUT/VDD pins should be DC blocked to ensure proper operation.

The SKY67023-396LF operates in the frequency range of 2.2 to 3.0 GHz. For lower frequency operation, the pin-compatible SKY67022-396LF or SKY67021-396LF should be used.

The LNA is manufactured in a compact, 2 x 2 mm, 8-pin Dual Flat No-Lead (DFN) package. A functional block diagram is shown in Figure 1. The pin configuration and package are shown in Figure 2. Signal pin assignments and functional pin descriptions are provided in Table 1.

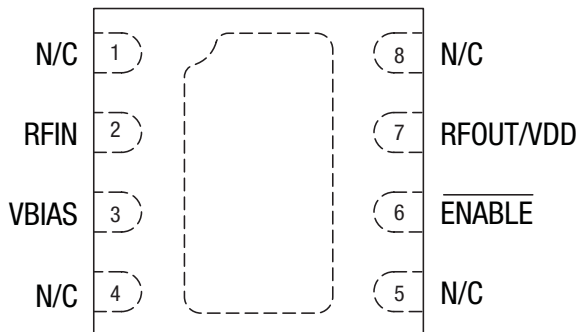

S2240

Figure 2. SKY67023-396LF Pinout (Top View)

Table 1. SKY67023-396LF Signal Descriptions

Pin	Name	Description	Pin	Name	Description
1	N/C	No connection. May be connected to ground with no change in performance.	5	N/C	No connection. May be connected to ground with no change in performance.
2	RFIN	RF input. DC blocking capacitor required.	6	$\overline{\text{ENABLE}}$	Enable pin. Active “low” (0 V) = amplifier on state.
3	VBIAS	Bias for 1 st stage amplifier. External resistor sets current consumption.	7	RFOUT/VDD	RF output. Apply VDD through RF choke inductor. DC blocking capacitor required.
4	N/C	No connection. May be connected to ground with no change in performance.	8	N/C	No connection. May be connected to ground with no change in performance.

Table 2. SKY67023-396LF Absolute Maximum Ratings¹

Parameter	Symbol	Minimum	Typical	Maximum	Units
Supply voltage	V _{DD}		5.0	5.5	V
RF input power	P _{IN}			+20	dBm
Channel temperature	T _{CH}			+150	°C
Thermal resistance (@ 5 V bias)	Θ _{JC}		62.2		°C/W
Storage temperature	T _{STG}	-65	+25	+150	°C
Operating temperature	T _A	-55	+25	+100	°C
Electrostatic discharge:	ESD				
Charged Device Model (CDM), Class 4		1000			V
Human Body Model (HBM), Class 1A		250			V
Machine Model (MM), Class A		30			V

¹ Exposure to maximum rating conditions for extended periods may reduce device reliability. There is no damage to device with only one parameter set at the limit and all other parameters set at or below their nominal value. Exceeding any of the limits listed here may result in permanent damage to the device.

ESD HANDLING: *Although this device is designed to be as robust as possible, electrostatic discharge (ESD) can damage this device. This device must be protected at all times from ESD when handling or transporting. Static charges may easily produce potentials of several kilovolts on the human body or equipment, which can discharge without detection. Industry-standard ESD handling precautions should be used at all times.*

Electrical and Mechanical Specifications

The absolute maximum ratings of the SKY67023-396LF are provided in Table 2. Electrical specifications are provided in Table 3.

Typical performance characteristics of the SKY67023-396LF are illustrated in Figures 3 through 25.

Table 4 provides noise source pull information versus frequency.

Table 3. SKY67023-396LF Electrical Specifications¹
(V_{DD} = 5 V, I_{DD} = 100 mA, T_A = +25 °C, P_{IN} = -20 dBm, Characteristic Impedance [Z₀] = 50 Ω, Unless Otherwise Noted)

Parameter	Symbol	Test Condition	Min	Typical	Max	Units
RF Specifications						
Noise figure ²	NF	@ 2.6 GHz		0.89	1.15	dB
Small signal gain	IS21I	@ 2.6 GHz	16.3	17.3	18.3	dB
Input return loss	IS11I	@ 2.6 GHz	12.0	14.5		dB
Output return loss	IS22I	@ 2.6 GHz	9.0	12.5		dB
Reverse isolation	IS12I	@ 2.6 GHz	26.2	29.2		dB
Third order input intercept point	IIP3	@ 2.6 GHz, Δf = 1 MHz, P _{IN} = -20 dBm/tone	+20.0	+22.2		dBm
Third order output intercept point	OIP3	@ 2.6 GHz, Δf = 1 MHz, P _{IN} = -20 dBm/tone	+37.3	+39.5		dBm
1 dB input compression point	IP1dB	@ 2.6 GHz	+2.0	+3.2		dBm
1 dB output compression point	OP1dB	@ 2.6 GHz	+18.3	+19.5		dBm
Stability ³	μ, μ1	Up to 18 GHz, -40 °C to +85 °C		> 1		-
DC Specifications						
Supply voltage	V _{DD}			5.0	5.5	V
Quiescent supply current	I _{DD}	Set with external resistor	90	100	120	mA
Amplifier enable off current (logic "high") ⁴	I _{EN}		700	900	1100	μA
Enable voltage:	V _{ENABLE}					
Gain mode				0	0.2	V
Power-down mode				1.5	5.5	V
Enable rise time ⁵	T _R	@ 2.6 GHz		250	500	ns
Enable fall time ⁵	T _F	@ 2.6 GHz		250	500	ns

¹ Performance is guaranteed only under the conditions listed in this table.

² Loss from the input SMA connector and Evaluation Board up to component M1 has been de-embedded from the NF measurement (0.06 dB).

³ Applies to typical application circuit and components shown in Figure 28.

⁴ Applications of high signal levels applied to the RFIN pin while in the amplifier "off" state may cause the device to self-bias and partially turn back on.

⁵ Tested with a 100 kHz square wave, 1000 pF capacitance-to-ground on the ENABLE pin. Switching time improves by reducing the value of, or eliminating, the 1000 pF capacitor on pin 6 (component M10 in Figure 28).

Typical Performance Characteristics

(VDD = 5 V, IDD = 100 mA, TA = +25 °C, PIN = -20 dBm, Characteristic Impedance [Zo] = 50 Ω, Unless Otherwise Noted)

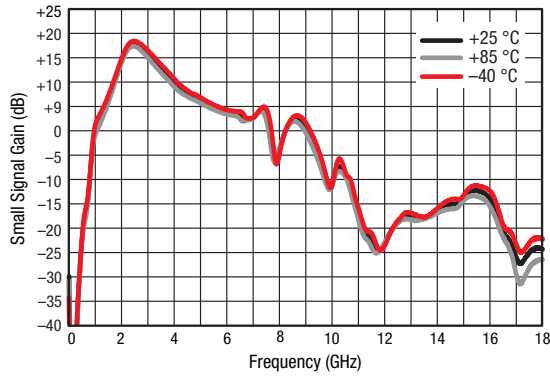

Figure 3. Broadband Gain Response vs Frequency Over Temperature

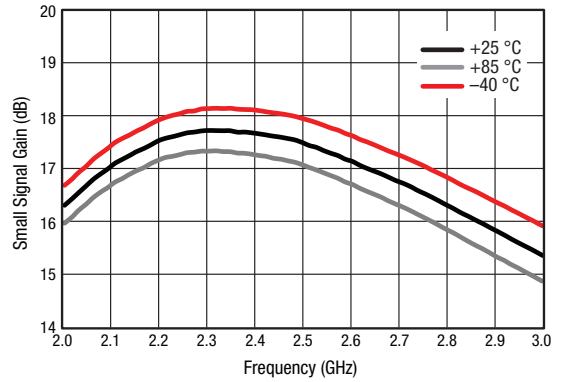

Figure 4. Narrowband Gain Response vs Frequency Over Temperature

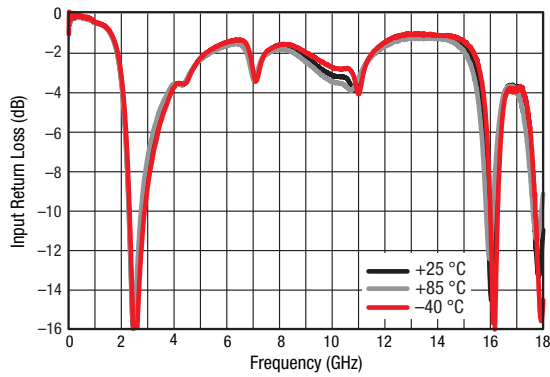

Figure 5. Broadband Input Return Loss vs Frequency Over Temperature

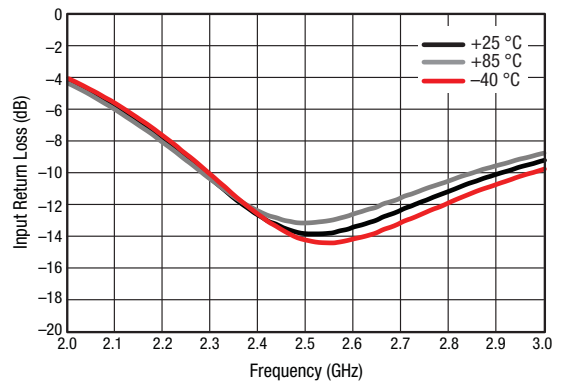

Figure 6. Narrowband Input Return Loss vs Frequency Over Temperature

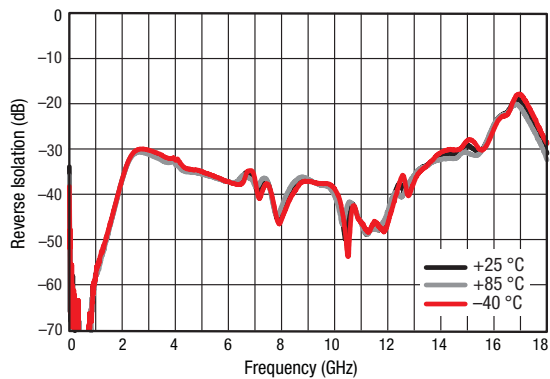

Figure 7. Broadband Reverse Isolation vs Frequency Over Temperature

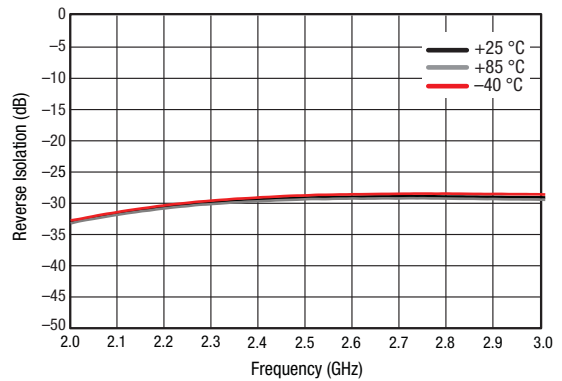

Figure 8. Narrowband Reverse Isolation vs Frequency Over Temperature

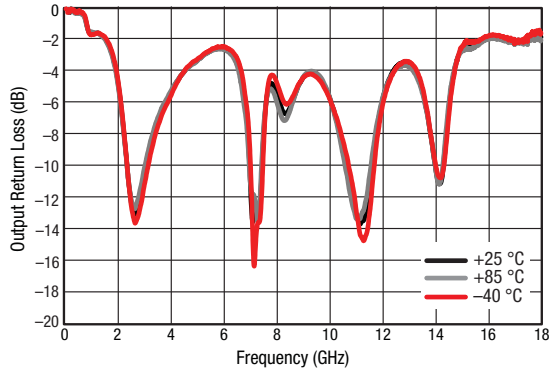

Figure 9. Broadband Output Return Loss vs Frequency Over Temperature

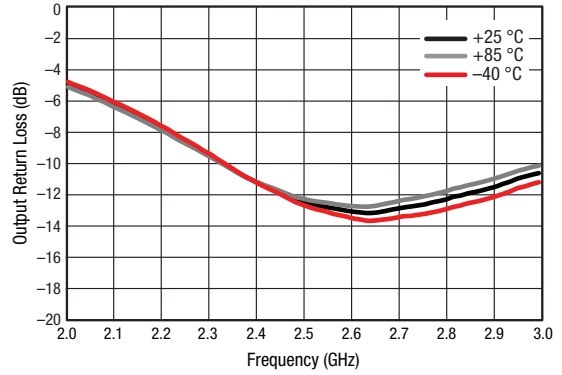

Figure 10. Narrowband Output Return Loss vs Frequency Over Temperature

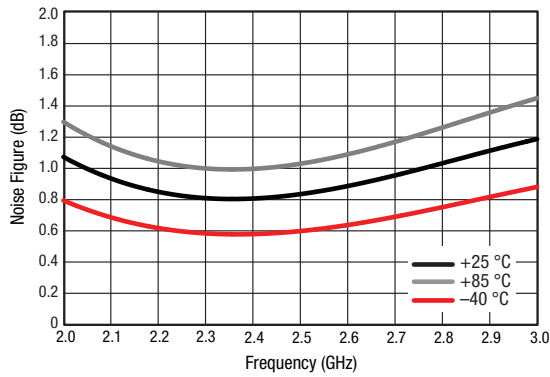

Figure 11. Noise Figure vs Frequency Over Temperature

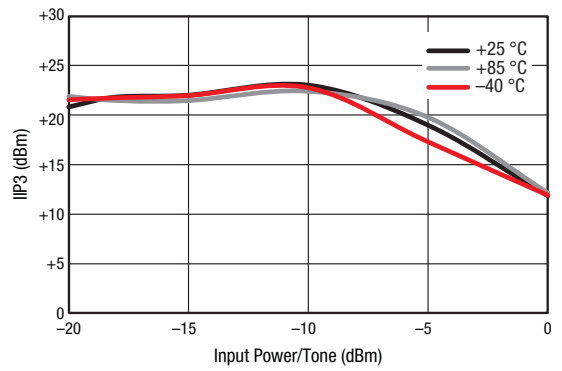

Figure 12. IIP3 vs Input Power Over Temperature @ 2200 MHz ($P_{IN} = -20$ dBm, Tone Spacing = 1 MHz)

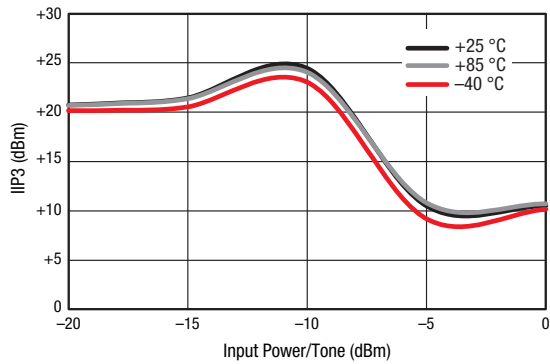

Figure 13. IIP3 vs Input Power Over Temperature @ 2500 MHz ($P_{IN} = -20$ dBm, Tone Spacing = 1 MHz)

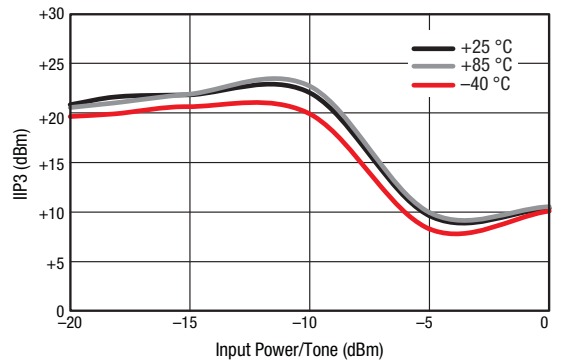

Figure 14. IIP3 vs Input Power Over Temperature @ 2600 MHz ($P_{IN} = -20$ dBm, Tone Spacing = 1 MHz)

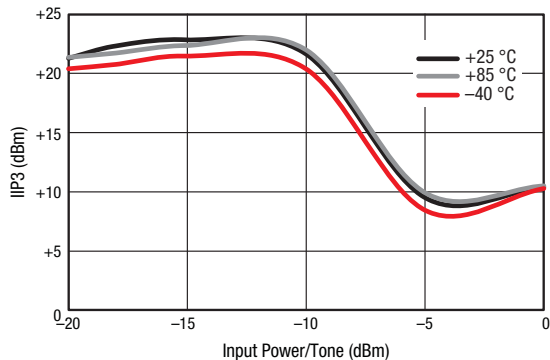

Figure 15. IIP3 vs Input Power Over Temperature @ 2700 MHz (P_{IN} = -20 dBm, Tone Spacing = 1 MHz)

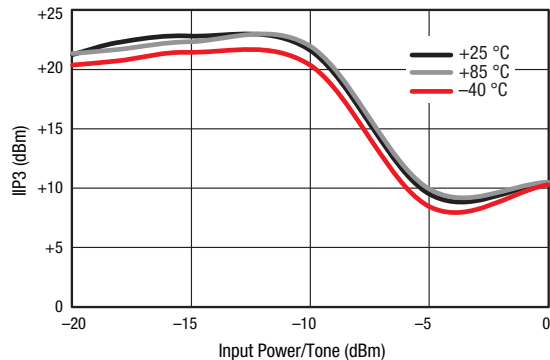

Figure 16. IIP3 vs Input Power Over Temperature @ 3000 MHz (P_{IN} = -20 dBm, Tone Spacing = 1 MHz)

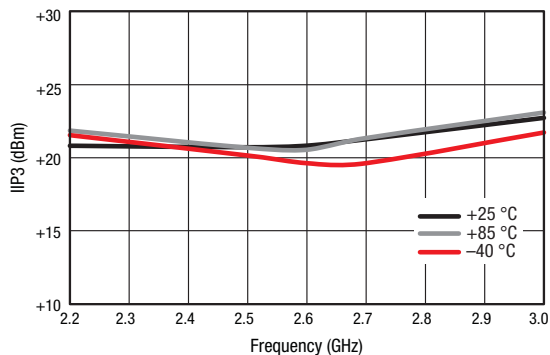

Figure 17. IIP3 vs Frequency Over Temperature (P_{IN} = -20 dBm, Tone Spacing = 1 MHz)

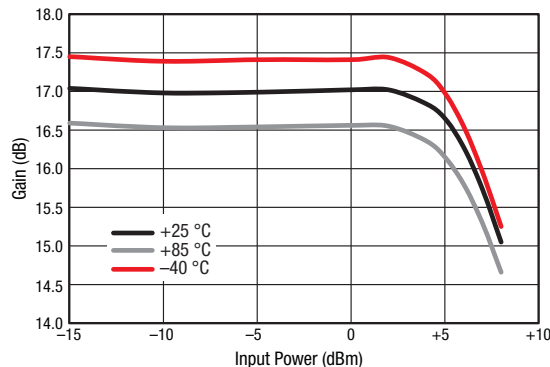

Figure 18. Gain vs Input Power Over Temperature @ 2200 MHz

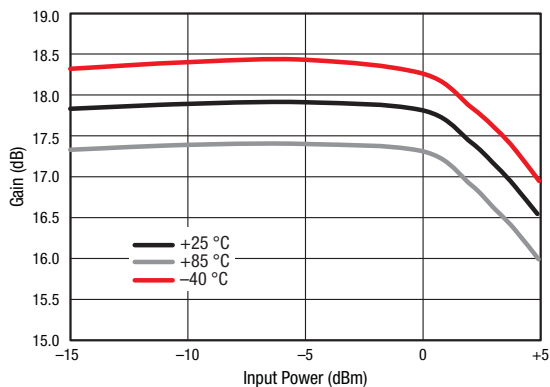

Figure 19. Gain vs Input Power Over Temperature @ 2500 MHz

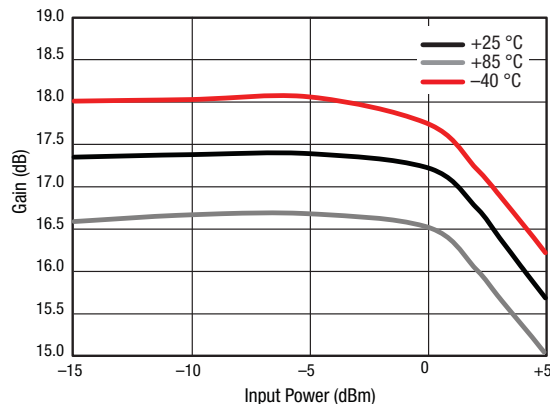

Figure 20. Gain vs Input Power Over Temperature @ 2600 MHz

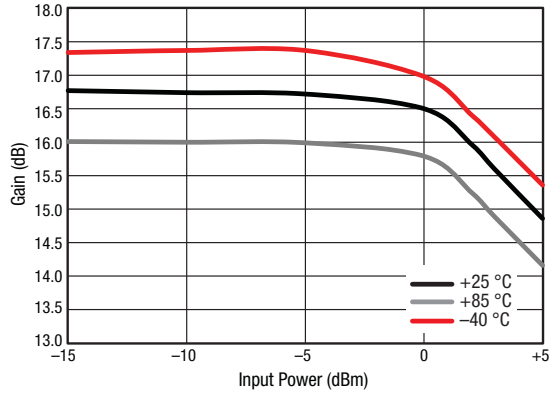

Figure 21. Gain vs Input Power Over Temperature @ 2700 MHz

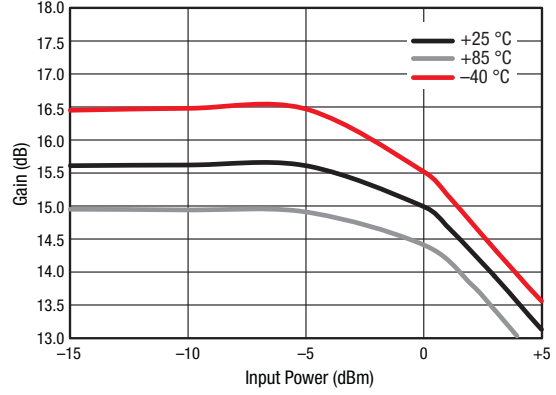

Figure 22. Gain vs Input Power Over Temperature @ 3000 MHz

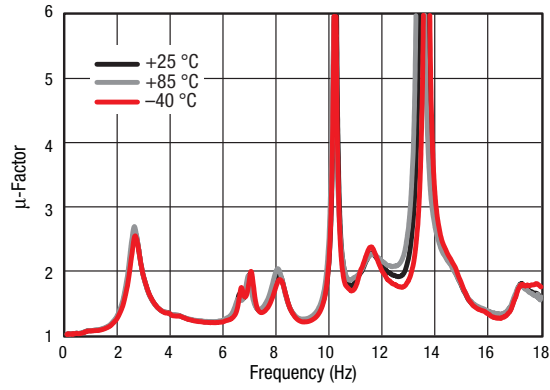

Figure 23. Stability Factor (μ) vs Frequency Over Temperature

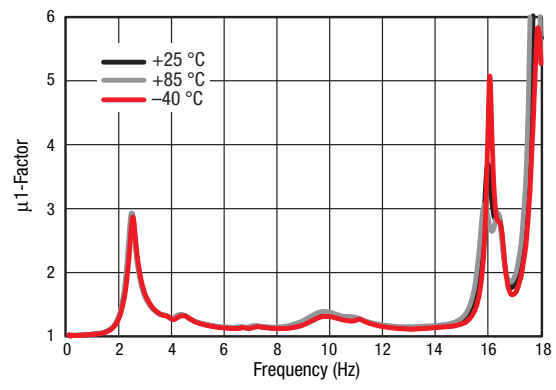
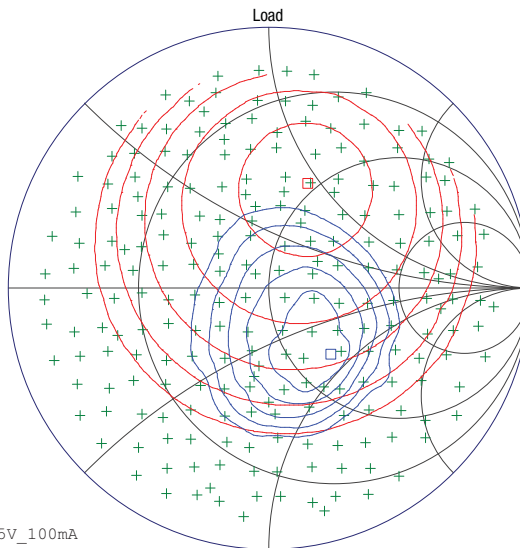

Figure 24. Stability Factor (μ_1) vs Frequency Over Temperature

Swept F1 Load Gamma Pull
 Freq = 2.6000 GHz
 TSource: 0.4482< 178.13

Gt max = 18.45 dB
 at 0.4286< 69.60
 5 contours, 1.00 dB step
 (14.00 to 18.00 dB)
 Ip3 max = 40.45 dBm
 at 0.3477< -47.19
 5 contours, 0.50 dBm step
 (38.00 to 40.00 dBm)
 Specs: OFF



Label:
 OIP3_SKY67023_production_260MHz_5V_100mA

Figure 25. Load Pull, @ 5 V, 2600 MHz, 100 mA

Table 4. Noise Parameters vs Frequency @ 25 °C (1 of 3)

Frequency (GHz)	Minimum Noise Figure (F _{MN}) (dB)	Noise Resistance (R _N) (Ω)	Γ _{opt}		Associated Gain (dB)	Maximum Gain (G _{MAX}) (dB)
			Magnitude	Phase		
0.50	0.410	0.047	0.244	+79.766	28.237	29.999
0.55	0.406	0.045	0.251	+84.050	27.809	29.451
0.60	0.402	0.043	0.258	+88.232	27.395	28.922
0.65	0.400	0.041	0.264	+92.313	26.993	28.413
0.70	0.398	0.040	0.271	+96.294	26.605	27.922
0.75	0.398	0.038	0.279	+100.177	26.230	27.450
0.80	0.398	0.037	0.286	+103.963	25.867	26.995
0.85	0.400	0.035	0.293	+107.652	25.516	26.558
0.90	0.402	0.034	0.300	+111.246	25.177	26.137
0.95	0.406	0.033	0.307	+114.746	24.850	25.734
1.00	0.410	0.032	0.315	+118.153	24.534	25.346
1.05	0.415	0.031	0.322	+121.469	24.229	24.974
1.10	0.420	0.030	0.329	+124.694	23.935	24.618
1.15	0.427	0.029	0.337	+127.830	23.652	24.276
1.20	0.434	0.028	0.344	+130.877	23.378	23.949
1.25	0.442	0.027	0.352	+133.838	23.114	23.635
1.30	0.451	0.027	0.359	+136.712	22.860	23.336
1.35	0.461	0.026	0.367	+139.502	22.616	23.049

Table 4. Noise Parameters vs Frequency @ 25 °C (2 of 3)

Frequency (GHz)	Minimum Noise Figure (F _{MIN}) (dB)	Noise Resistance (R _N) (Ω)	Γ _{opt}		Associated Gain (dB)	Maximum Gain (G _{MAX}) (dB)
			Magnitude	Phase		
1.40	0.471	0.026	0.374	+142.208	22.380	22.775
1.45	0.482	0.025	0.381	+144.832	22.153	22.514
1.50	0.493	0.025	0.389	+147.374	21.935	22.264
1.55	0.505	0.025	0.396	+149.836	21.724	22.026
1.60	0.517	0.025	0.403	+152.219	21.522	21.798
1.65	0.530	0.025	0.410	+154.524	21.327	21.582
1.70	0.544	0.025	0.418	+156.752	21.139	21.375
1.75	0.558	0.025	0.425	+158.905	20.959	21.179
1.80	0.572	0.025	0.432	+160.983	20.785	20.991
1.85	0.587	0.025	0.439	+162.987	20.618	20.813
1.90	0.602	0.025	0.446	+164.920	20.456	20.642
1.95	0.618	0.026	0.452	+166.782	20.301	20.480
2.00	0.634	0.026	0.459	+168.573	20.151	20.326
2.05	0.650	0.027	0.466	+170.296	20.007	20.179
2.10	0.666	0.027	0.472	+171.951	19.867	20.038
2.15	0.683	0.028	0.478	+173.540	19.733	19.904
2.20	0.700	0.029	0.484	+175.064	19.602	19.776
2.25	0.717	0.029	0.490	+176.523	19.476	19.653
2.30	0.734	0.030	0.496	+177.920	19.354	19.535
2.35	0.752	0.031	0.502	+179.254	19.235	19.422
2.40	0.769	0.032	0.508	-179.472	19.120	19.313
2.45	0.787	0.033	0.513	-178.258	19.007	19.208
2.50	0.805	0.034	0.518	-177.102	18.897	19.106
2.55	0.823	0.035	0.523	-176.004	18.790	19.007
2.60	0.841	0.036	0.528	-174.961	18.685	18.910
2.65	0.858	0.038	0.533	-173.974	18.582	18.816
2.70	0.876	0.039	0.538	-173.040	18.480	18.723
2.75	0.894	0.040	0.542	-172.160	18.379	18.631
2.80	0.911	0.042	0.546	-171.330	18.280	18.541
2.85	0.929	0.043	0.550	-170.551	18.181	18.450
2.90	0.946	0.045	0.553	-169.822	18.083	18.360
2.95	0.964	0.046	0.557	-169.140	17.985	18.269

Table 4. Noise Parameters vs Frequency @ 25 °C (3 of 3)

Frequency (GHz)	Minimum Noise Figure (F _{MIN}) (dB)	Noise Resistance (R _N) (Ω)	Γ _{opt}		Associated Gain (dB)	Maximum Gain (G _{MAX}) (dB)
			Magnitude	Phase		
3.00	0.981	0.048	0.560	-168.506	17.886	18.177
3.05	0.997	0.050	0.563	-167.917	17.787	18.083
3.10	1.014	0.051	0.565	-167.373	17.688	17.988
3.15	1.030	0.053	0.568	-166.873	17.587	17.891
3.20	1.046	0.055	0.570	-166.414	17.485	17.791
3.25	1.062	0.057	0.572	-165.998	17.382	17.688
3.30	1.077	0.059	0.573	-165.621	17.277	17.582
3.35	1.092	0.061	0.574	-165.283	17.169	17.471
3.40	1.106	0.063	0.575	-164.983	17.059	17.357
3.45	1.120	0.065	0.576	-164.719	16.947	17.237
3.50	1.134	0.067	0.576	-164.492	16.831	17.112
3.55	1.147	0.069	0.576	-164.298	16.712	16.982
3.60	1.160	0.071	0.576	-164.138	16.589	16.846
3.65	1.172	0.074	0.575	-164.009	16.463	16.703
3.70	1.183	0.076	0.574	-163.912	16.332	16.553
3.75	1.194	0.078	0.573	-163.845	16.197	16.396
3.80	1.204	0.081	0.571	-163.806	16.057	16.232
3.85	1.214	0.083	0.569	-163.794	15.912	16.059
3.90	1.223	0.086	0.566	-163.809	15.762	15.877
3.95	1.231	0.088	0.564	-163.849	15.606	15.687
4.00	1.239	0.091	0.560	-163.913	15.444	15.487

Evaluation Board Description

The SKY67023-396LF Evaluation Board is used to test the performance of the SKY67023-396LF LNA. An assembly drawing for the Evaluation Board is shown in Figure 26. The layer detail is provided in Figure 27. An Evaluation Board schematic diagram is provided in Figure 28. Table 5 provides the Bill of Materials (BOM) list for Evaluation Board components.

Package Dimensions

The PCB layout footprint for the SKY67023-396LF is provided in Figure 29. Typical part markings are shown in Figure 30. Package dimensions are shown in Figure 31, and tape and reel dimensions are provided in Figure 32.

Package and Handling Information

Instructions on the shipping container label regarding exposure to moisture after the container seal is broken must be followed. Otherwise, problems related to moisture absorption may occur when the part is subjected to high temperature during solder assembly.

The SKY67023-396LF is rated to Moisture Sensitivity Level 1 (MSL1) at 260 °C. It can be used for lead or lead-free soldering. For additional information, refer to the Skyworks Application Note, *Solder Reflow Information*, document number 200164.

Care must be taken when attaching this product, whether it is done manually or in a production solder reflow environment. Production quantities of this product are shipped in a standard tape and reel format.

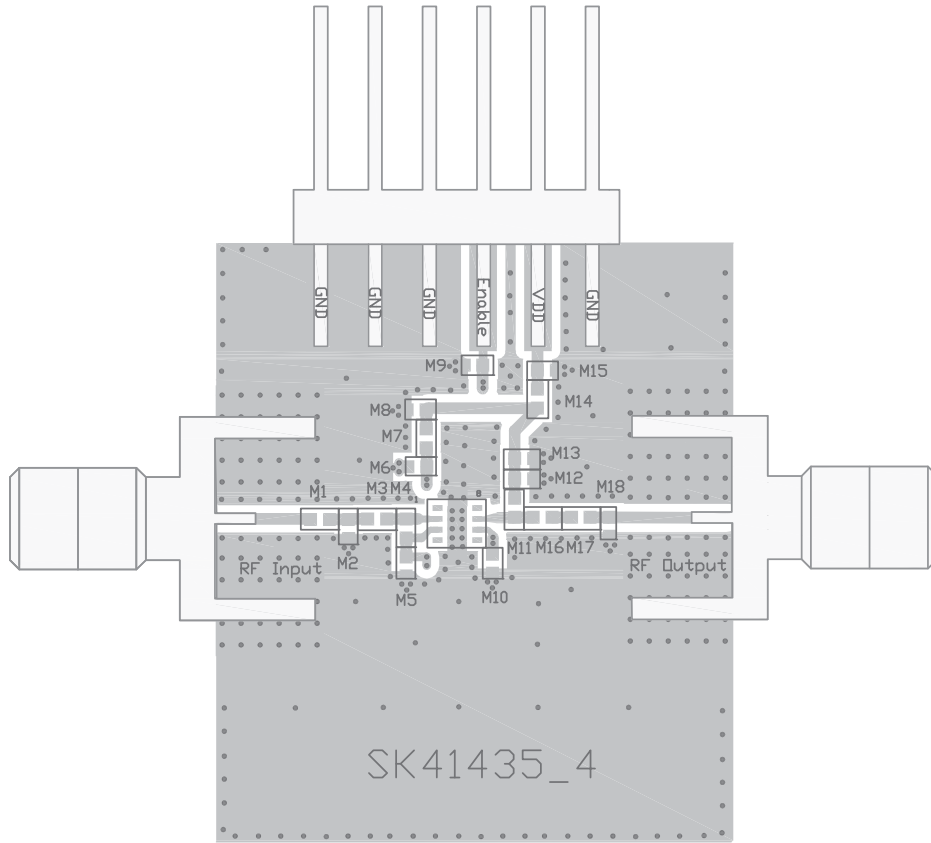

S2528

Figure 26. SKY67023-396LF Evaluation Board Assembly Diagram

Cross Section	Name	Thickness (mm)	Material
	MSK-NS		
	TRA-NS	0.03556	Cu foil
	Laminate	0.254 ± 0.152	Rogers 4350B
	TRA-2	0.0178	Cu foil
	Laminate	0.889 nom.	FR4 Prepreg (Note 1)
	TRA-3	0.0178	Cu foil
	Laminate	0.254 ± 0.152	FR4 Core
	TRA-FS	0.0178	Cu foil
	MSK-PS		

Note 1: Adjust this thickness to meet total thickness goal.

General Notes:

Material: Rogers R04350, $\epsilon_r = 3.66$
 Layer 1 thickness: 0.254 mm
 Overall board thickness: 1.575 mm
 50 Ω transmission line width: 0.522 mm
 Coplanar ground spacing: 0.394 mm
 Via diameter: 0.254 mm

S2530

Figure 27. Layer Detail Physical Characteristics

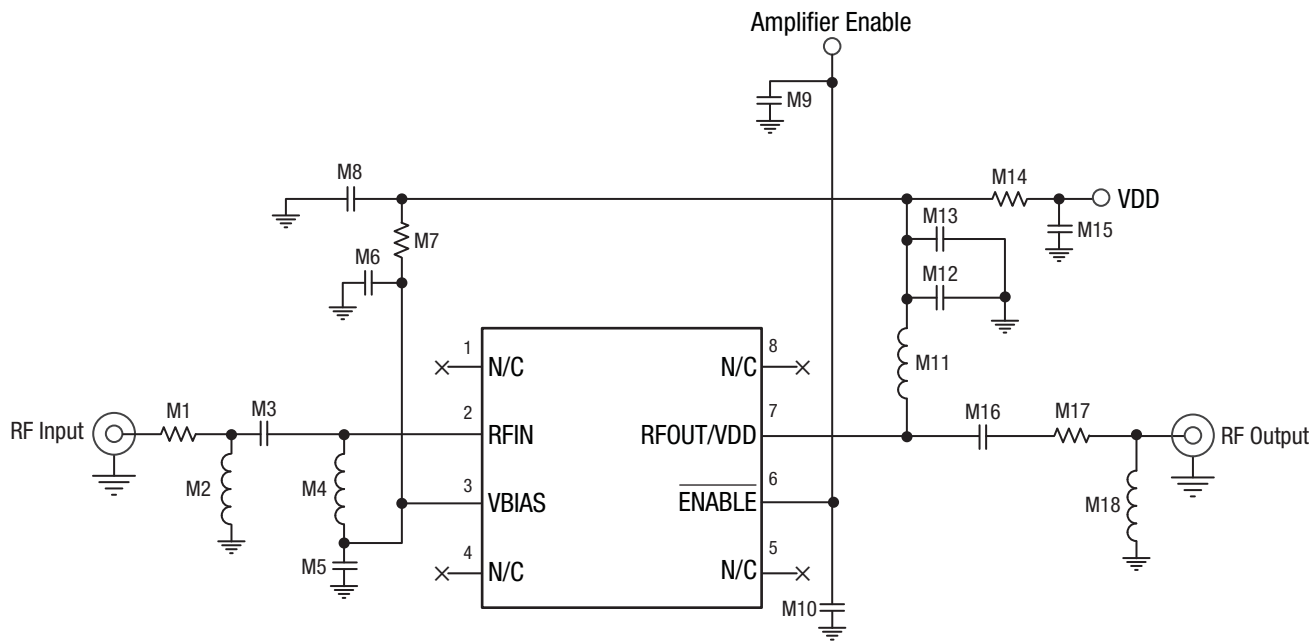

S2254b

Figure 28. SKY67023-396LF Evaluation Board Schematic

Table 5. SKY67023-396LF Evaluation Board Bill of Materials

Component	Type	Size	Value (5 V @ 100 mA)	Manufacturer	Mfr Part Number
M1	Resistor	0402	0 Ω	Panasonic	ERJ-2GE0R00X
M2	Inductor	0402	2 nH	Coilcraft	0402HP-2N0XJLU
M3	Capacitor	0402	1.6 pF	Murata	GJM1555C1H1R6CB01
M4	Inductor	0402	15 nH	Coilcraft	0402HP-15NXGLU
M5	Capacitor	0402	6 pF	Murata	GJM1555C1H6R0CB01
M6	DNI	0402	-	-	-
M7	Resistor	0402	5.6 kΩ	Panasonic	ERJ-2GEJ562X
M8	Capacitor	0402	1000 pF	Murata	GRM1555C1H102JA01
M9	Capacitor	0402	1000 pF	Murata	GRM1555C1H102JA01
M10	DNI	0402	-	-	-
M11	Inductor	0402	39 nH	TDK	MLG1005S39NJ
M12	Capacitor	0402	10 pF	Murata	GRM1555C1H100JZ01D
M13	Capacitor	0402	1000 pF	Murata	GRM1555C1H102JA01
M14	Resistor	0402	0 Ω	Panasonic	ERJ-2GE0R00X
M15	0402	0402	0.1 μF	Murata	GRM155R71A104KA01
M16	Capacitor	0402	2.2 pF	Murata	GRM1555C1H2R2CZ01
M17	Resistor	0402	0 Ω	Panasonic	ERJ-2GE0R00X
M18	Inductor	0402	2.7 nH	TDK	MLG1005S2N7S

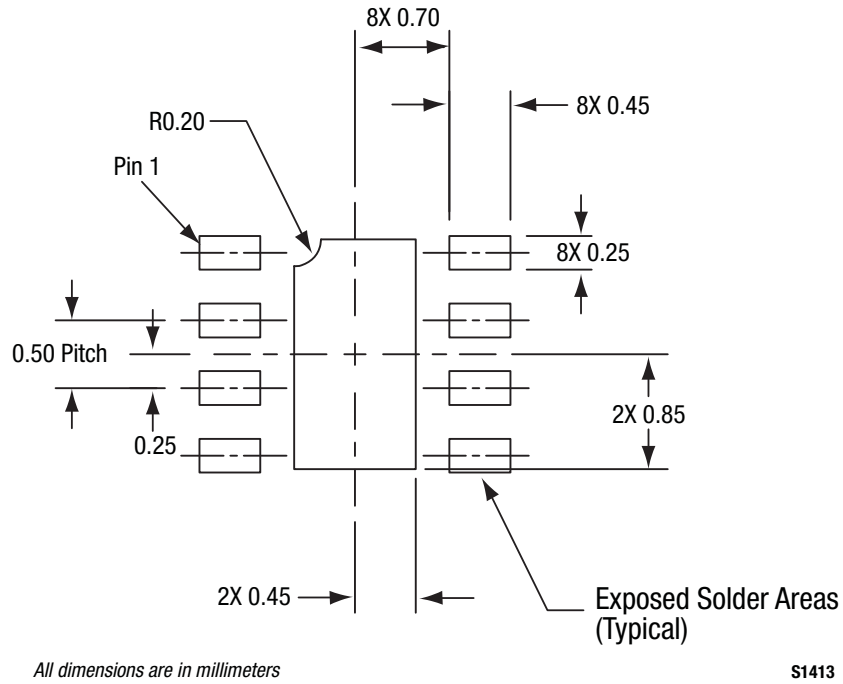

Figure 29. SKY67023-396LF PCB Layout Footprint (Top View)

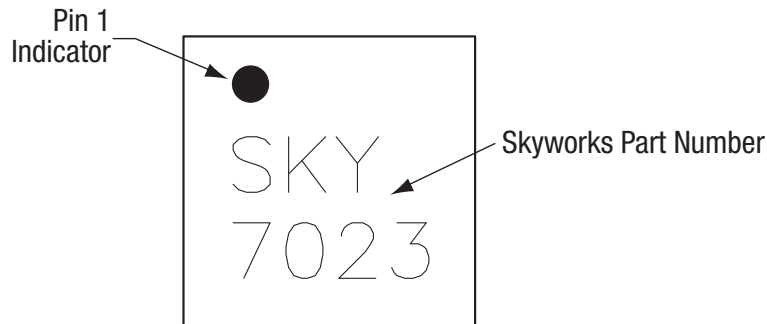
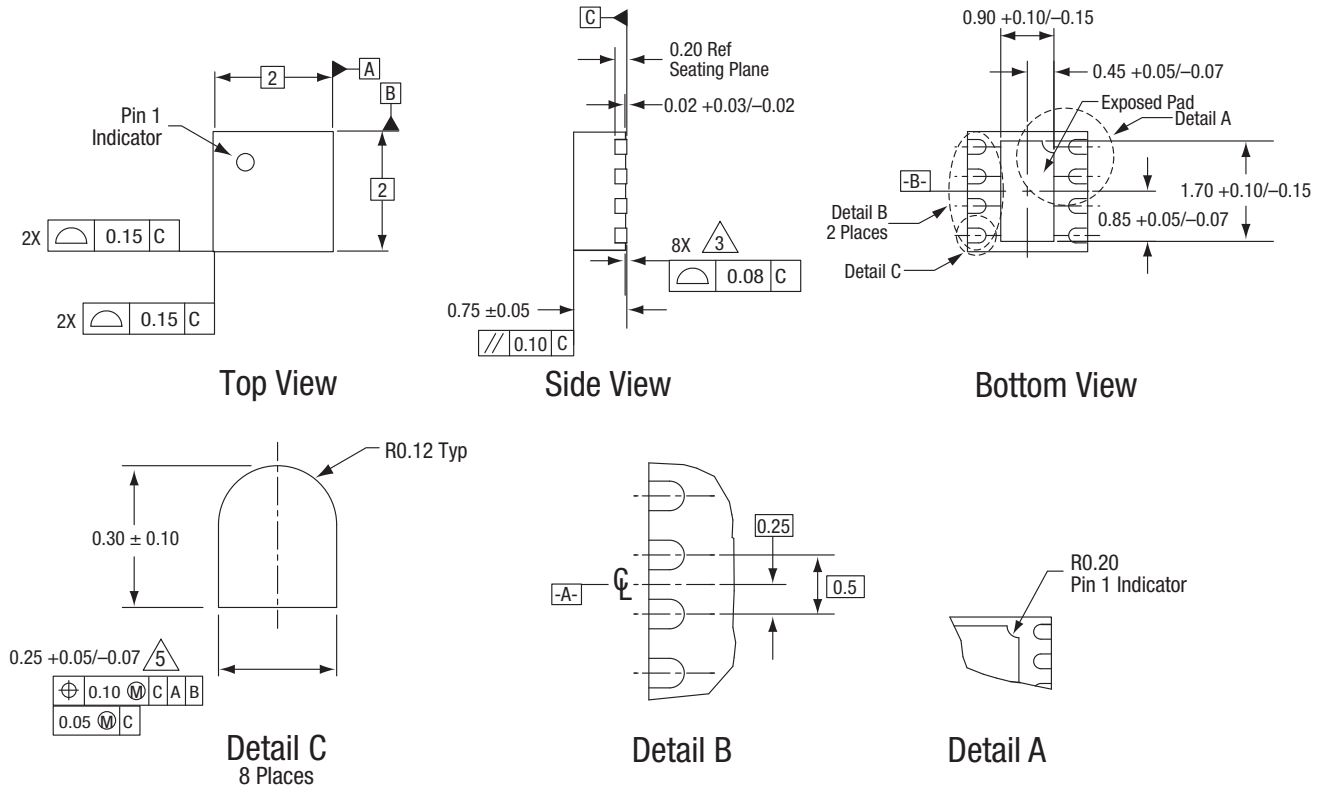

Figure 30. Typical Part Markings (Top View)



Notes:

1. All measurements are in millimeters.
2. Dimensions and tolerances according to ASME Y14.5M-1994.
3. Coplanarity applies to the exposed heat sink ground pad as well as the terminals.
4. Plating requirement per source control drawing (SCD) 2504.
5. Dimension applies to metallized terminal and is measured between 0.15 mm and 0.30 mm from terminal tip.

S1945

Figure 31. SKY67023-396LF Package Dimensions

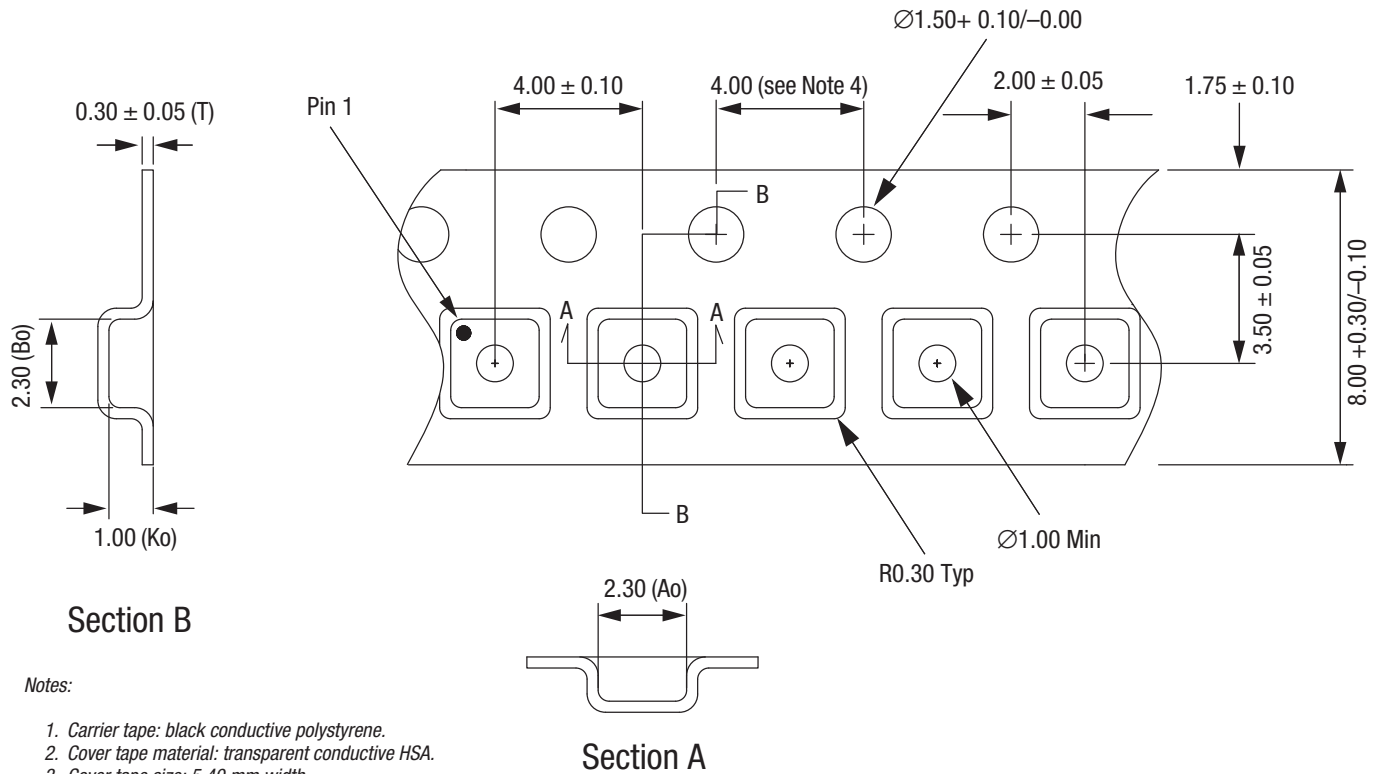

Notes:

1. Carrier tape: black conductive polystyrene.
2. Cover tape material: transparent conductive HSA.
3. Cover tape size: 5.40 mm width.
4. Ten sprocket hole pitch cumulative tolerance = ±0.20 mm.
5. ESD surface resistivity is $\leq 1 \times 10^8$ Ohms/square per EIA, JEDEC tape and reel specification.
6. Ao and Bo measurement point to be 0.30 mm from bottom pocket.
7. All measurements are in millimeters.

S1601

Figure 32. SKY67023-396LF Tape and Reel Dimensions

Ordering Information

Model Name	Manufacturing Part Number	Evaluation Board Part Number
SKY67023-396LF LNA	SKY67023-396LF	SKY67023-396LF-EVB

Copyright © 2013, 2016 Skyworks Solutions, Inc. All Rights Reserved.

Information in this document is provided in connection with Skyworks Solutions, Inc. ("Skyworks") products or services. These materials, including the information contained herein, are provided by Skyworks as a service to its customers and may be used for informational purposes only by the customer. Skyworks assumes no responsibility for errors or omissions in these materials or the information contained herein. Skyworks may change its documentation, products, services, specifications or product descriptions at any time, without notice. Skyworks makes no commitment to update the materials or information and shall have no responsibility whatsoever for conflicts, incompatibilities, or other difficulties arising from any future changes.

No license, whether express, implied, by estoppel or otherwise, is granted to any intellectual property rights by this document. Skyworks assumes no liability for any materials, products or information provided hereunder, including the sale, distribution, reproduction or use of Skyworks products, information or materials, except as may be provided in Skyworks Terms and Conditions of Sale.

THE MATERIALS, PRODUCTS AND INFORMATION ARE PROVIDED "AS IS" WITHOUT WARRANTY OF ANY KIND, WHETHER EXPRESS, IMPLIED, STATUTORY, OR OTHERWISE, INCLUDING FITNESS FOR A PARTICULAR PURPOSE OR USE, MERCHANTABILITY, PERFORMANCE, QUALITY OR NON-INFRINGEMENT OF ANY INTELLECTUAL PROPERTY RIGHT; ALL SUCH WARRANTIES ARE HEREBY EXPRESSLY DISCLAIMED. SKYWORKS DOES NOT WARRANT THE ACCURACY OR COMPLETENESS OF THE INFORMATION, TEXT, GRAPHICS OR OTHER ITEMS CONTAINED WITHIN THESE MATERIALS. SKYWORKS SHALL NOT BE LIABLE FOR ANY DAMAGES, INCLUDING BUT NOT LIMITED TO ANY SPECIAL, INDIRECT, INCIDENTAL, STATUTORY, OR CONSEQUENTIAL DAMAGES, INCLUDING WITHOUT LIMITATION, LOST REVENUES OR LOST PROFITS THAT MAY RESULT FROM THE USE OF THE MATERIALS OR INFORMATION, WHETHER OR NOT THE RECIPIENT OF MATERIALS HAS BEEN ADVISED OF THE POSSIBILITY OF SUCH DAMAGE.

Skyworks products are not intended for use in medical, lifesaving or life-sustaining applications, or other equipment in which the failure of the Skyworks products could lead to personal injury, death, physical or environmental damage. Skyworks customers using or selling Skyworks products for use in such applications do so at their own risk and agree to fully indemnify Skyworks for any damages resulting from such improper use or sale.

Customers are responsible for their products and applications using Skyworks products, which may deviate from published specifications as a result of design defects, errors, or operation of products outside of published parameters or design specifications. Customers should include design and operating safeguards to minimize these and other risks. Skyworks assumes no liability for applications assistance, customer product design, or damage to any equipment resulting from the use of Skyworks products outside of stated published specifications or parameters.

Skyworks and the Skyworks symbol are trademarks or registered trademarks of Skyworks Solutions, Inc., in the United States and other countries. Third-party brands and names are for identification purposes only, and are the property of their respective owners. Additional information, including relevant terms and conditions, posted at www.skyworksinc.com, are incorporated by reference.