

R60D – DC Operated Rotary Variable Inductance Transducer



- Lower cost than RVDTs
- Bipolar DC operation
- ± 60 degree sensing range
- High level VDC output
- Light-weight
- Non contact design
- Size 11 servo mount
- Anodized aluminum housing

DESCRIPTION

The **R60D** RVIT (Rotary Variable Inductance Transducer) is a DC operated non-contact angular position sensor. Operating on a ± 15 VDC supply, the R60D provides a smooth ± 7.5 VDC output proportional to angular position over a ± 60 degree sensing range.

The RVIT proprietary design utilizes a set of four printed circuit coils and a light-weight conductive spoiler to achieve superior performance with a low moment of inertia. During operation, the light weight spoiler rotates with the transducer shaft, differentially altering the inductance of the printed circuit planar coils. The resulting unbalance is precisely measured using a patented autoplex circuit. This signal is then converted to a linear DC output voltage, proportional to the angle of the rotor shaft. The digital circuit is extremely resistant to environmental disturbances such as EMI and RFI, and is compatible for use with most analog position feedback systems.

Calibrated for use over the full ± 60 degree sensing range, the R60D offers exceptional performance at a cost effective price. It also features a wide operating temperature range, infinite resolution, and an extremely long rotational cycle life.

Also see our other DC operated, angular position sensor models, **RVIT-15 Series** (single ended DC operation, voltage or current output), **R120LC** (+5VDC operation, low cost) and **R30D** (bipolar DC operated RVDT).

Measurement Specialties, Inc. (NASDAQ MEAS) offers many other types of sensors and signal conditioners. Data sheets can be downloaded from our web site at: <http://www.meas-spec.com/datasheets.aspx>

*MEAS acquired Schaevitz Sensors and the **Schaevitz**® trademark in 2000.*

FEATURES

- Wide temperature range
- ± 7.5 VDC output
- Internal voltage regulation
- Low moment of inertia
- Shielded ABEC 3 precision bearings
- Rugged aluminum housing

APPLICATIONS

- Ball valve position
- Throttle level position feedback
- Rotary actuator feedback
- Dancer arm position
- Reeler / Dereeler

R60D – DC Operated Rotary Variable Inductance Transducer

PERFORMANCE SPECIFICATIONS

ELECTRICAL SPECIFICATIONS	
Input voltage	+/-15VDC ±10%
Input current	25mA maximum
Angular range	±60 degrees
Non linearity	±0.5% of FR
Output at range ends	+/-7.5VDC
Sensitivity	125mV/degree
Temp. coefficient of output	±0.02% of FRO per °F [0.036% of FRO per °C], over operating temperature range
Output current	5mA maximum
Output impedance	1Ω maximum
Non repeatability & hysteresis	0.1% of FRO maximum
Frequency response	200Hz @ -3dB

ENVIRONMENTAL AND MECHANICAL SPECIFICATIONS	
Operating temperature	-13°F to +185°F [-25°C to 85°C]
Storage temperature	-67°F to +257°F [-55°C to 125°C]
Mechanical angular range	360 degrees (no stops)
Bearings	Shielded ABEC 3 precision
Shaft diameter	3/16 inch [4.76mm]
Housing material	Aluminum, black anodized
Mounting	Size 11 servo mount BU-ORD
Maximum torque, unbalance	0.12 inch.ounce-force [8.6 gram-force.cm]
Shaft load capability	10 lb [4.5Kg] Axial or Radial
Electrical connection	4 lead wires, AWG 24, PTFE insulation, 12 inches [30cm] long
Weight	1.2 oz [34 grams]

Notes:

All values are nominal unless otherwise noted

FR (Full Range) is the angular range, end to end; $2 \times A^\circ$ for $\pm A^\circ$ angular range

FRO (Full Range Output): Algebraic difference in outputs measured at the ends of the range

DIMENSIONS

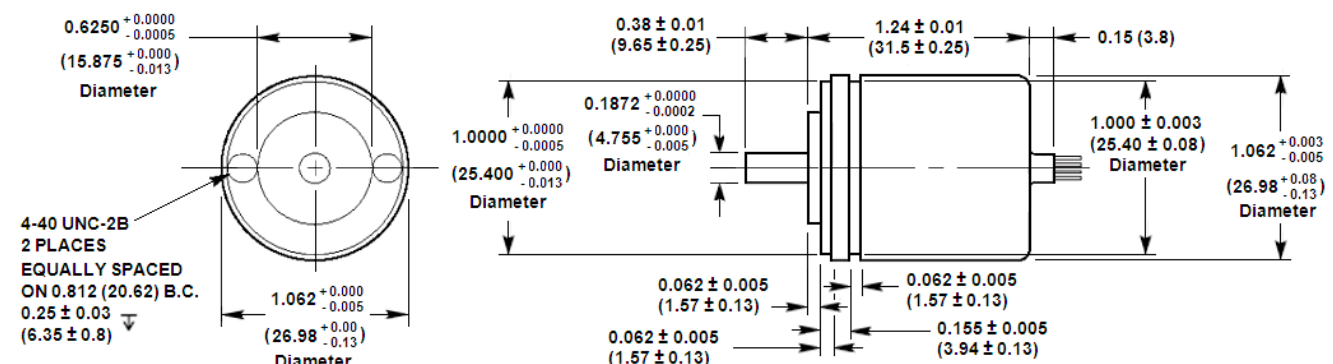

Dimensions are in inch (mm)

R60D – DC Operated Rotary Variable Inductance Transducer

WIRING INFORMATION

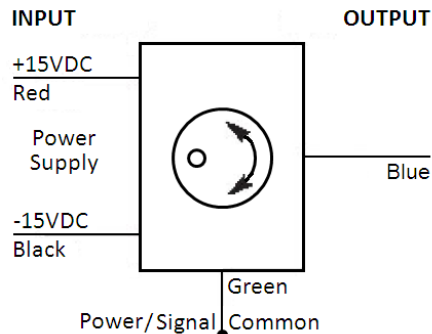

ORDERING INFORMATION

Description	Model	Part Number
RVIT $\pm 60^\circ$	R60D	02192500-060
ACCESSORIES		
R-FLEX multipurpose coupling kit	R-FLEX	66530072-000
Dual rail DC power supply ($\pm 15\text{VDC}$)	PSD 4-15	02291331-000

Refer to our [“RVDT and RVIT Accessories”](#) data sheet for other accessories.

TECHNICAL CONTACT INFORMATION

NORTH AMERICA	EUROPE	ASIA
Measurement Specialties, Inc. 1000 Lucas Way Hampton, VA 23666 United States Phone: +1-800-745-8008 Fax: +1-757-766-4297 Email: sales@meas-spec.com Web: www.meas-spec.com	MEAS Deutschland GmbH Hauert 13 D-44227 Dortmund Germany Phone: +49-(0)231-9740-0 Fax: +49-(0)231-9740-20 Email: info.de@meas-spec.com Web: www.meas-spec.com	Measurement Specialties China Ltd. No. 26, Langshan Road High-tech Park (North) Nanshan District, Shenzhen 518057 China Phone: +86-755-33305088 Fax: +86-755-33305099 Email: info.cn@meas-spec.com Web: www.meas-spec.com

The information in this sheet has been carefully reviewed and is believed to be accurate; however, no responsibility is assumed for inaccuracies. Furthermore, this information does not convey to the purchaser of such devices any license under the patent rights to the manufacturer. Measurement Specialties, Inc. reserves the right to make changes without further notice to any product herein. Measurement Specialties, Inc. makes no warranty, representation or guarantee regarding the suitability of its product for any particular purpose, nor does Measurement Specialties, Inc. assume any liability arising out of the application or use of any product or circuit and specifically disclaims any and all liability, including without limitation consequential or incidental damages. Typical parameters can and do vary in different applications. All operating parameters must be validated for each customer application by customer's technical experts. Measurement Specialties, Inc. does not convey any license under its patent rights nor the rights of others.