

SMU Series

SMD, single-turn, sealed cermet trimmers



- Available in J-hook and gull-wing terminal configurations
- Meets EIA, EIAJ, IPC, VECI standard SMD trimmer designs
- Pb-free and Cd-free construction
- RoHS compliant
- Gold-plated leads provide high conductivity, low contact resistance, high corrosion resistance and good solderability
- Top cross-slot adjustment (top single-slot models available as special order)
- Tape and reel packaging



SERIES SPECIFICATIONS

Series	Wattage	Manufactured Range (Ω)	Rotation	Adj. Location	Taper	Tolerance
SMUA	0.125	50-2M	$250^\circ \pm 10^\circ$	Top	Linear	20%
SMUB	0.25	50-2M	$250^\circ \pm 10^\circ$	Top	Linear	20%

CHARACTERISTICS

Standard Resistance Range	50 Ω to 2M Ω (standard 1, 2 & 5 sequence)	Low Temperature Operation	-55°C, 0.125 watt, 1 hour	$\Delta T/R \leq \pm 2\%$, S.S. $\leq \pm 2\%$
Resistance Tolerance	$\pm 20\%$ standard	High Temp. Exposure	+125°C, 250 hours	$\Delta T/R \leq \pm 2\%$, S.S. $\leq \pm 2\%$
End Resistance	1% or 3 Ω , whichever is greater	Load Life	+70°C, 0.125 watt, 1,000 hours	$\Delta T/R \leq \pm 3\%$, S.S. $\leq \pm 2\%$
Temp. Range	-55°C to +125°C	Thermal Shock	-55°C, +125°C, 30 minutes each, 5 cycles	$\Delta T/R \leq \pm 2\%$, S.S. $\leq \pm 1\%$
Resistance Taper	Linear	Shock	100G, 6ms, 6 directions, 3 times each	$\Delta T/R \leq \pm 1\%$, S.S. $\leq \pm 1\%$
Peak Noise (C.R.V.)	2% or 3 Ω , whichever is greater	Vibration	10-2,000Hz, 1.5mm amplitude, 20G, 12 hours	$\Delta T/R \leq \pm 1\%$, S.S. $\leq \pm 1\%$
Power Rating	SMUA 0.125w @70°C; 0w @+125°C SMUB 0.250w @70°C; 0w @+125°C	Humidity	+40°C, 90-95%RH, 0.125 watt, 500 hours	$\Delta T/R \leq \pm 3\%$, S.S. $\leq \pm 2\%$
Maximum Input Voltage	200VDC or power rating, whichever is smaller	Moisture Resistance	-10°C to +65°C, 80-98%RH, 0.125 watt, 10 cycles, 240 hours	$\Delta T/R \leq \pm 3\%$
Temperature Coefficient	± 100 ppm/°C, 200 Ω to 1M Ω ± 250 ppm/°C, other values	Soldering Heat Resistance	240°C, 10 seconds	$\Delta T/R \leq \pm 1\%$
Insulation Resistance	100M Ω minimum at 500VDC	Seal Test	+85°C, hot water for 1 minute	
Dielectric Strength	500VAC, 1 minute	Rotational Life	100 cycles without discontinuity, no load	$\Delta T/R \leq \pm 5\%$
Adjustment Travel	$250^\circ \pm 10^\circ$			
Mechanical Travel	$250^\circ \pm 10^\circ$			
Shaft Torque	0 gf•cm (0.69 oz•in) max.			
Stop Strength	200 gf•cm (2.77 oz•in) min.			
Flammability of Plastic Materials	Meets UL 94V-0			
Nominal Weight	0.068g			

Marking Resistance value or code, date code

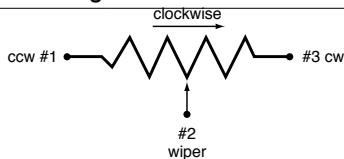

Position of Rotor Inside

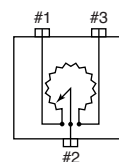

Outside Markings

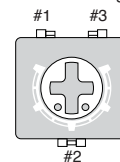

SMU Series

SMD, single-turn, sealed cermet trimmers

CHARACTERISTICS

(continued)

Flow Soldering Profile

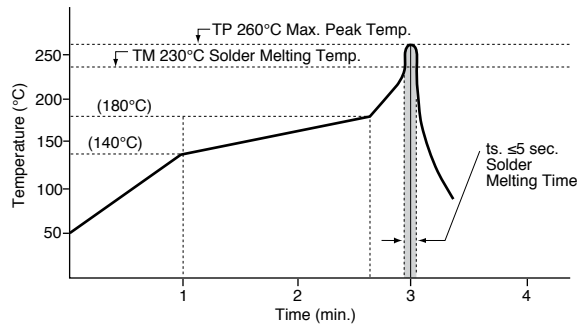

Reflow Soldering Profile

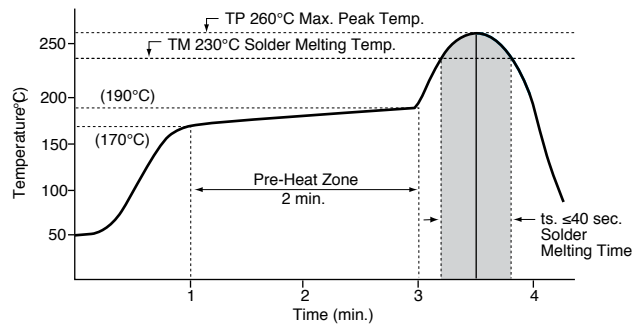

DIMENSIONS

(mm)

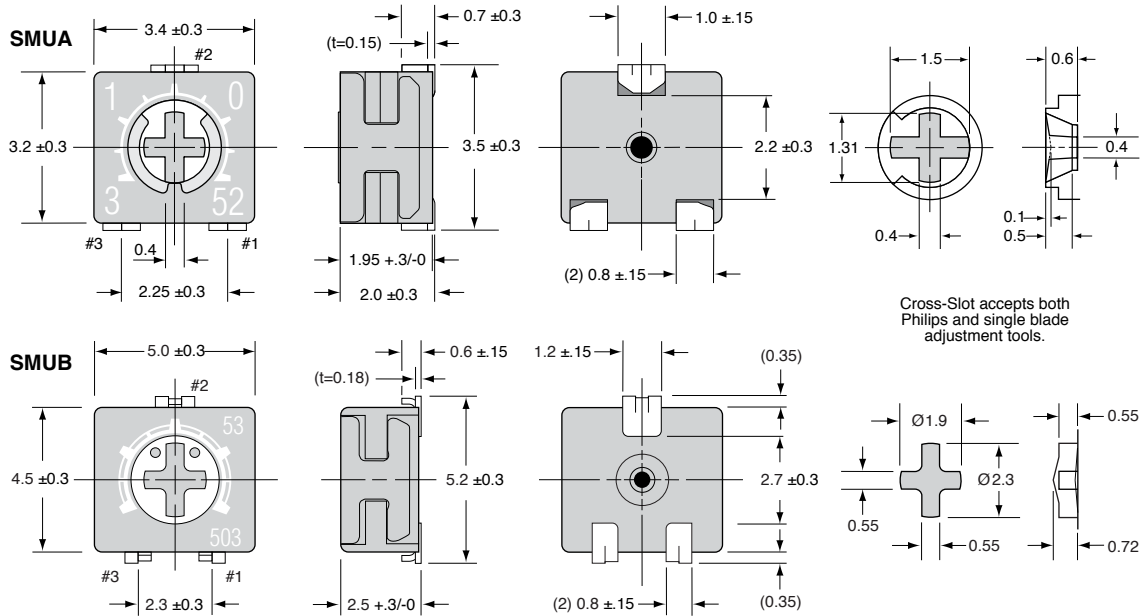

Land Pattern

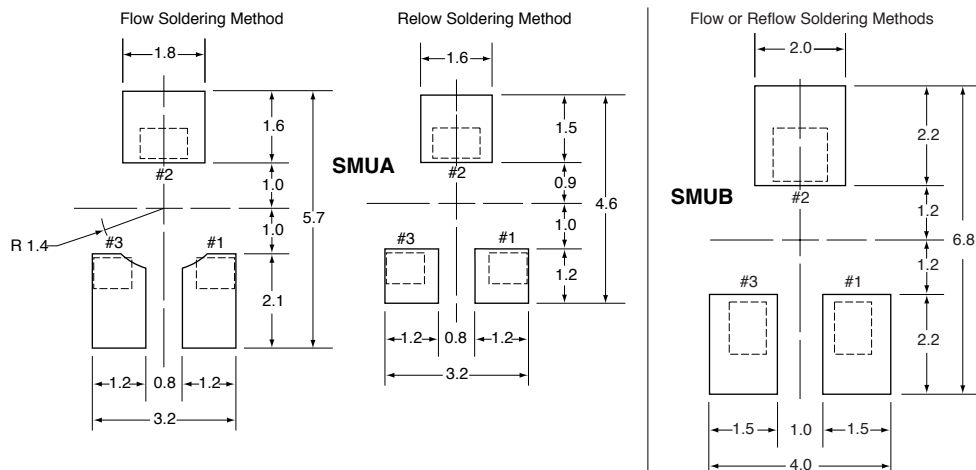

SMU Series

SMD, single-turn, sealed cermet trimmers

TAPE AND REEL

(mm)

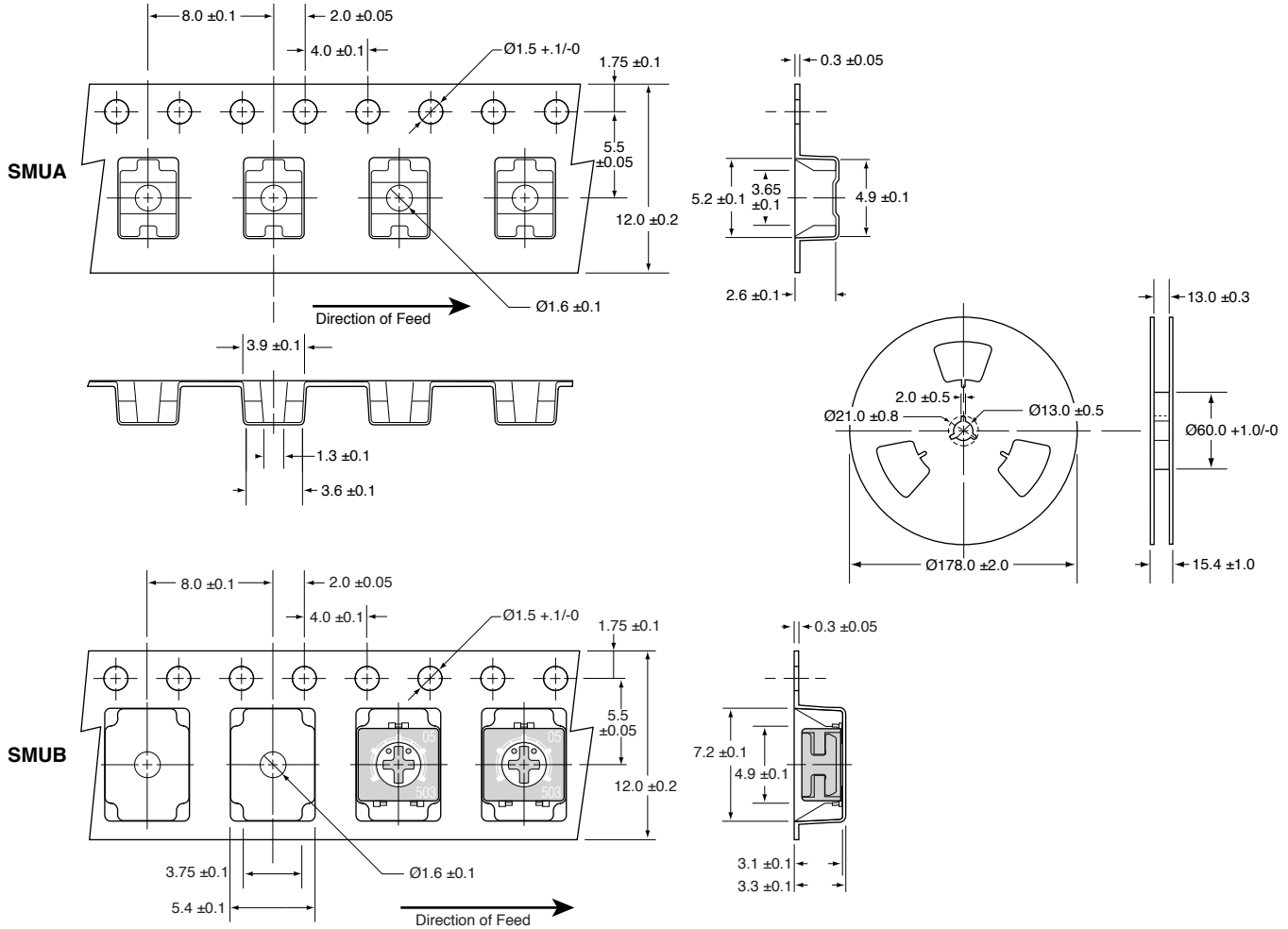

ORDERING INFORMATION

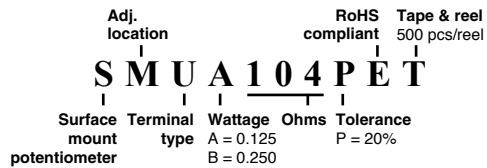

Standard Part Numbers

SMUA500PET	SMUB500PET
SMUA101PET	SMUB101PET
SMUA201PET	SMUB201PET
SMUA501PET	SMUB501PET
SMUA102PET	SMUB102PET
SMUA202PET	SMUB202PET
SMUA502PET	SMUB502PET
SMUA103PET	SMUB103PET
SMUA203PET	SMUB203PET
SMUA503PET	SMUB503PET
SMUA104PET	SMUB104PET
SMUA204PET	SMUB204PET
SMUA504PET	SMUB504PET
SMUA105PET	SMUB105PET