

CGHV50200F

200 W, 4400 - 5000 MHz, 50-Ohm Input/Output Matched, GaN HEMT

Cree's CGHV50200F is a gallium nitride (GaN) high electron mobility transistor (HEMT) designed specifically with high efficiency, high gain and wide bandwidth capabilities, which makes the CGHV50200F ideal for troposcatter communications, 4.4 - 5.0 GHz C-Band SatCom applications and Beyond Line of Sight. The GaN HEMT is matched to 50 ohm, for ease of use. It is designed for CW, pulse, and linear mode of power amplifier operation. The transistor is supplied in a ceramic/metal flange package, type 440217.



PN: CGHV50200F
Package Type: 440217

Typical Performance Over 4.4-5.0 GHz ($T_c = 25^\circ\text{C}$) of Demonstration Amplifier

Parameter	4.4 GHz	4.6 GHz	4.8 GHz	5.0 GHz	Units
Small Signal Gain	14.9	14.9	14.9	15.1	dB
CW Output Power ¹	173	177	170	166	W
Output Power ²	100	100	126	101	W
Power Gain ²	11.4	11.6	11.0	11.8	dB
Power Added Efficiency ²	49	47	48	48	%

¹Note: Measured CW in the CGHV50200F-AMP at $P_{IN} = 43$ dBm

²Note: Measured at -30 dBc, 1.6 MHz from carrier, in the CGHV50200F-AMP under OQPSK modulation, 1.6 Msps, PN23, Alpha Filter = 0.2.

Features

- 4.4 - 5.0 GHz Operation
- 180 W Typical P_{SAT}
- 11.5 dB Typical Power Gain
- 48% Typical Power Efficiency
- 50 Ohm Internally Matched

Applications

- Troposcatter Communications
- Beyond Line of Sight – BLOS
- Satellite Communications

Large Signal Models Available for ADS and MWO

Absolute Maximum Ratings (not simultaneous)

Parameter	Symbol	Rating	Units	Conditions
Drain-Source Voltage	V_{DS}	125	Volts	25°C
Gate-to-Source Voltage	V_{GS}	10, +2	Volts	25°C
Storage Temperature	T_{STG}	-65, +150	°C	
Operating Junction Temperature	T_J	225	°C	
Maximum Forward Gate Current	I_{GMAX}	41.6	mA	25°C
Maximum Drain Current ¹	I_{DMAX}	17	A	25°C
Soldering Temperature ²	T_S	245	°C	
Screw Torque	τ	40	in-oz	
Thermal Resistance, Junction to Case	$R_{\theta JC}$	0.81	°C/W	CW, 85°C, $P_{DISS} = 166.4$ W
Case Operating Temperature ³	T_C	-40, +125	°C	

Note:

¹ Current limit for long term, reliable operation

² Refer to the Application Note on soldering at <http://www.cree.com/rf/document-library>

³ See also, Power Dissipation Derating Curve on page 12

Electrical Characteristics

Characteristics	Symbol	Min.	Typ.	Max.	Units	Conditions
DC Characteristics¹ ($T_C = 25^\circ\text{C}$)						
Gate Threshold Voltage	$V_{GS(th)}$	-3.4	-3.0	-2.6	V_{DC}	$V_{DS} = 10$ V, $I_D = 41.6$ mA
Gate Quiescent Voltage	$V_{GS(Q)}$	-	-2.7	-	V_{DC}	$V_{DS} = 40$ V, $I_D = 1.0$ A
Saturated Drain Current ²	I_{DS}	33.28	37.4	-	A	$V_{DS} = 6$ V, $V_{GS} = 2$ V
Drain-Source Breakdown Voltage	V_{BR}	150	-	-	V_{DC}	$V_{GS} = -8$ V, $I_D = 41.6$ mA
RF Characteristics³ ($T_C = 25^\circ\text{C}$, $F_0 = 4.4 - 5.0$ GHz unless otherwise noted)						
Small Signal Gain	G_{SS1}	14	15.4	-	dB	$V_{DD} = 40$ V, $I_D = 1.0$ A, $P_{IN} = 10$ dBm, Freq = 4.4 GHz
Small Signal Gain	G_{SS2}	14	15.3	-	dB	$V_{DD} = 40$ V, $I_D = 1.0$ A, $P_{IN} = 10$ dBm, Freq = 4.8 GHz
Small Signal Gain	G_{SS3}	14.25	15.2	-	dB	$V_{DD} = 40$ V, $I_D = 1.0$ A, $P_{IN} = 10$ dBm, Freq = 5.0 GHz
Power Gain ⁴	G_{P1}	10.5	12.1	-	dB	$V_{DD} = 40$ V, $I_D = 1.0$ A, $P_{OUT} = 48$ dBm, Freq = 4.4 GHz
Power Gain ⁴	G_{P2}	10.5	12.4	-	dB	$V_{DD} = 40$ V, $I_D = 1.0$ A, $P_{OUT} = 48$ dBm, Freq = 4.8 GHz
Power Gain ⁴	G_{P3}	10.5	12.2	-	dB	$V_{DD} = 40$ V, $I_D = 1.0$ A, $P_{OUT} = 48$ dBm, Freq = 5.0 GHz
Power Added Efficiency ⁴	PAE_1	30	42	-	%	$V_{DD} = 40$ V, $I_D = 1.0$ A, $P_{OUT} = 48$ dBm, Freq = 4.4 GHz
Power Added Efficiency ⁴	PAE_2	30	37	-	%	$V_{DD} = 40$ V, $I_D = 1.0$ A, $P_{OUT} = 48$ dBm, Freq = 4.8 GHz
Power Added Efficiency ⁴	PAE_3	30	40	-	%	$V_{DD} = 40$ V, $I_D = 1.0$ A, $P_{OUT} = 48$ dBm, Freq = 5.0 GHz
OQPSK Linearity ⁴	$ACLR_1$	-	-29	-25	dBc	$V_{DD} = 40$ V, $I_D = 1.0$ A, $P_{OUT} = 48$ dBm, Freq = 4.4 GHz
OQPSK Linearity ⁴	$ACLR_2$	-	-34	-28	dBc	$V_{DD} = 40$ V, $I_D = 1.0$ A, $P_{OUT} = 48$ dBm, Freq = 4.8 GHz
OQPSK Linearity ⁴	$ACLR_3$	-	-34	-26	dBc	$V_{DD} = 40$ V, $I_D = 1.0$ A, $P_{OUT} = 48$ dBm, Freq = 5.0 GHz
Output Mismatch Stress	VSWR	-	-	3 : 1	Ψ	No damage at all phase angles, $V_{DD} = 40$ V, $I_D = 1.0$ A, CW $P_{OUT} = 180$ W

Notes:

¹ Measured on wafer prior to packaging.

² Scaled from PCM data.

³ Measured in CGHV50200F-AMP

⁴ Measured under 1.6 Msps OQPSK Modulation, PN23, Alpha Filter = 0.2

Typical Performance

**Figure 1. - Small Signal S-parameters
CGHV50200F in Test Fixture**
 $V_{DD} = 40\text{ V}, I_{DQ} = 1\text{ A}, T_{case} = 25^\circ\text{C}$

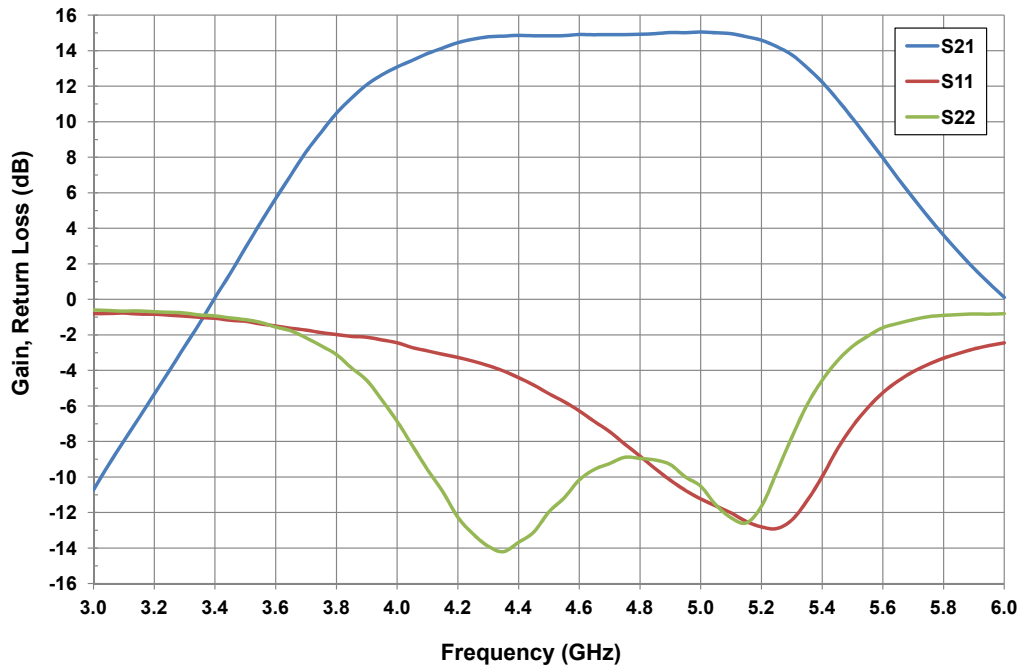

**Figure 2. - Modulated @ Spectral Regrowth = -30dBc, 1.6 MHz from Carrier
1.6 Msps OQPSK Modulation**
 $V_{DD} = 40\text{ V}, I_{DQ} = 1\text{ A}, T_{case} = 25^\circ\text{C}$

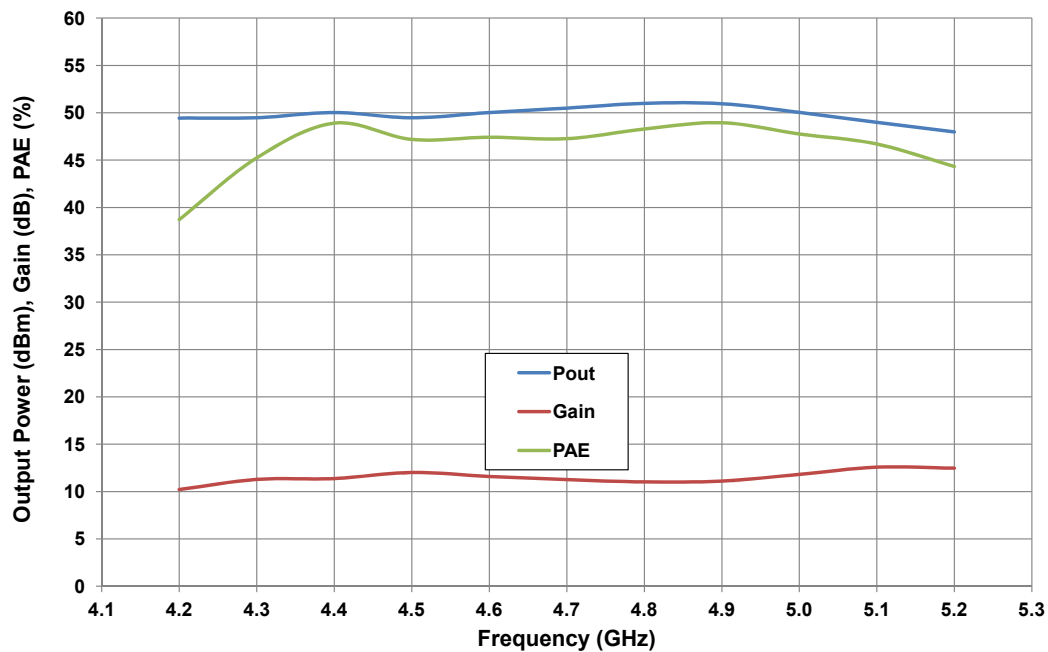

Typical Performance

Figure 3. - Spectral Mask @ Average Output Power = 48dBm
1.6 Msps OQPSK Modulation
 $V_{DD} = 40\text{ V}, I_{DQ} = 1\text{ A}, T_{case} = 25^\circ\text{C}$

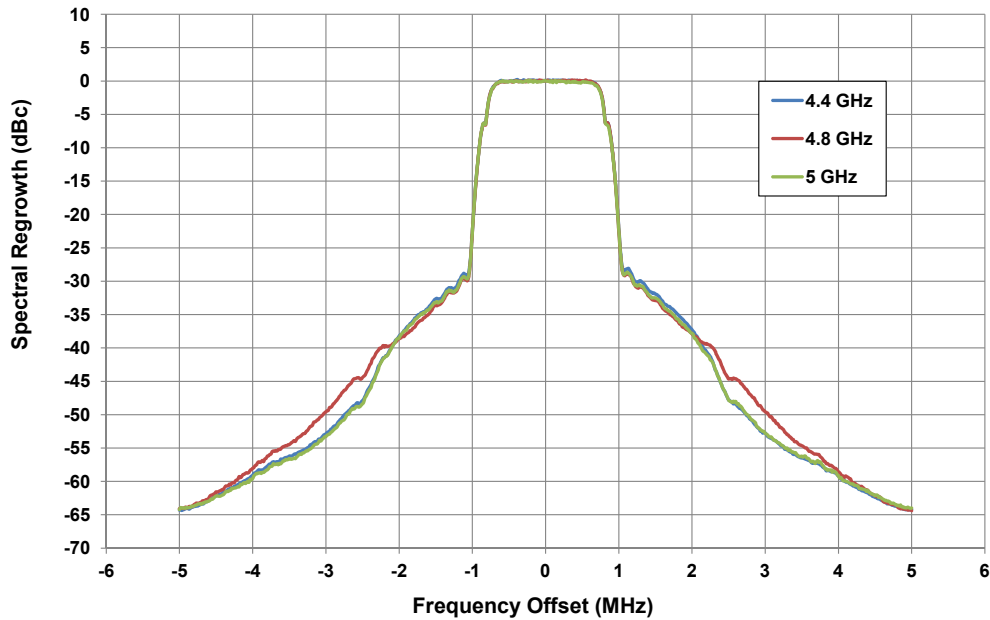
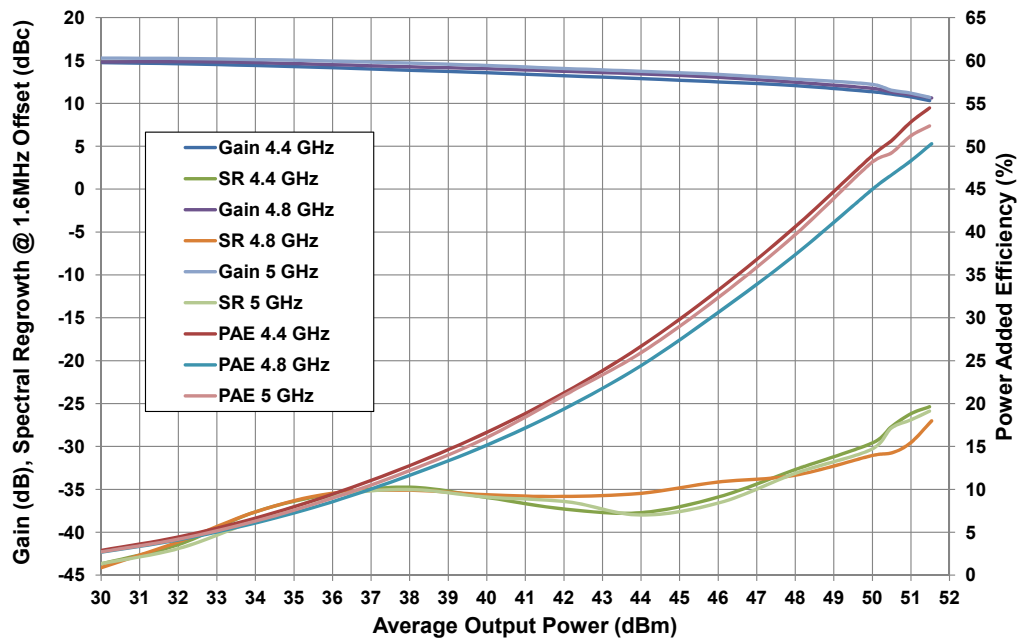

Figure 4. - Modulated Power Sweep
1.6 Msps OQPSK Modulation
 $V_{DD} = 40\text{ V}, I_{DQ} = 1\text{ A}, T_{case} = 25^\circ\text{C}$



Typical Performance

Figure 5. - Modulated Power Sweep
1.6 Msps OQPSK Modulation
 $V_{DD} = 40\text{ V}$, $I_{DQ} = 1\text{ A}$, $T_{case} = 25^\circ\text{C}$

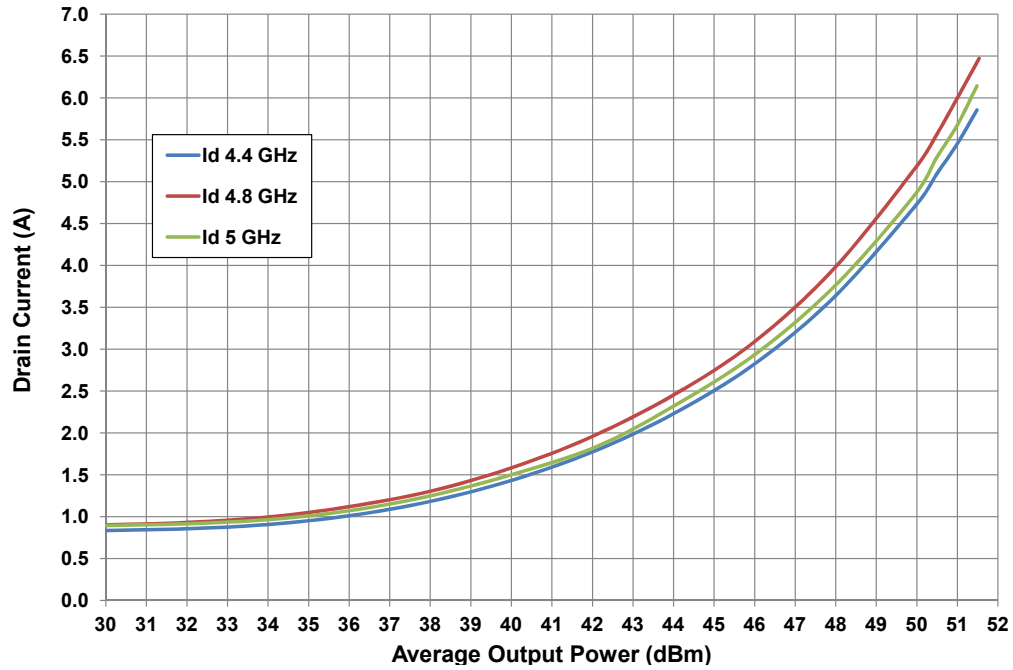
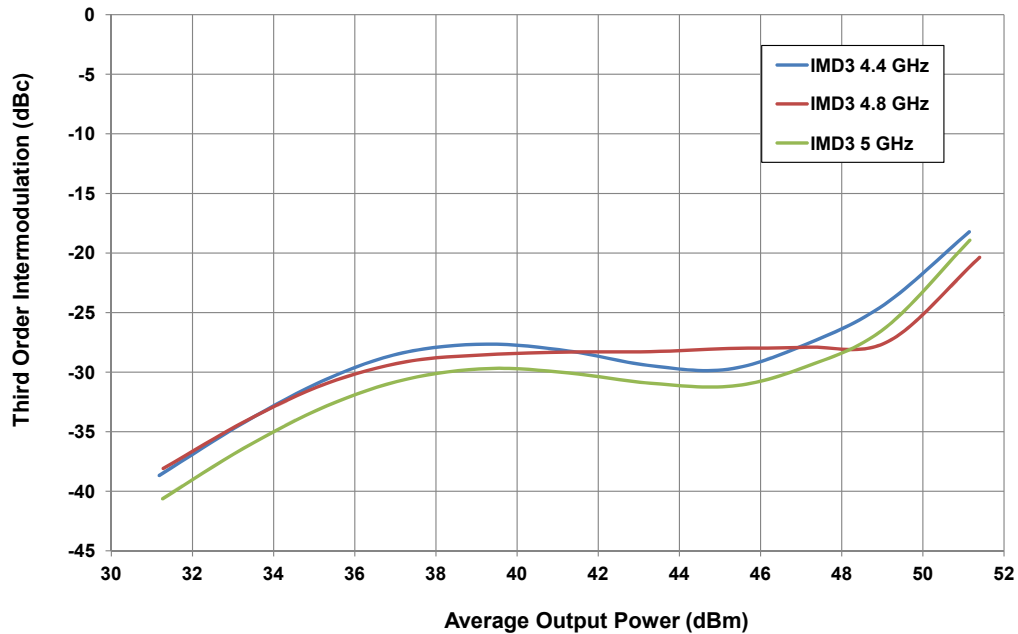
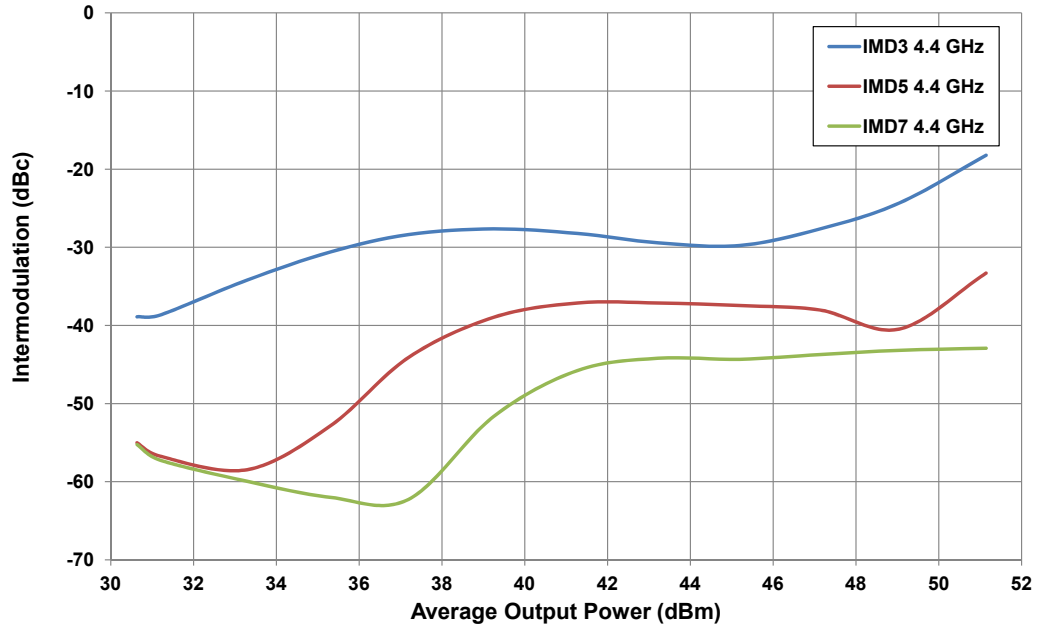

Figure 6. - Two Tone Power Sweep
IMD3 @ 1 MHz Carrier Spacing
 $V_{DD} = 40\text{ V}$, $I_{DQ} = 1\text{ A}$, $T_{case} = 25^\circ\text{C}$



Typical Performance

**Figure 7. - Two Tone Power Sweep
IMD @ 1 MHz Carrier Spacing, 4.4 GHz**
 $V_{DD} = 40\text{ V}$, $I_{DQ} = 1\text{ A}$, $T_{case} = 25^\circ\text{C}$



**Figure 8. - Two Tone Carrier Spacing Sweep
@ 48 dBm Average Output Power, 4.4 GHz**
 $V_{DD} = 40\text{ V}$, $I_{DQ} = 1\text{ A}$, $T_{case} = 25^\circ\text{C}$

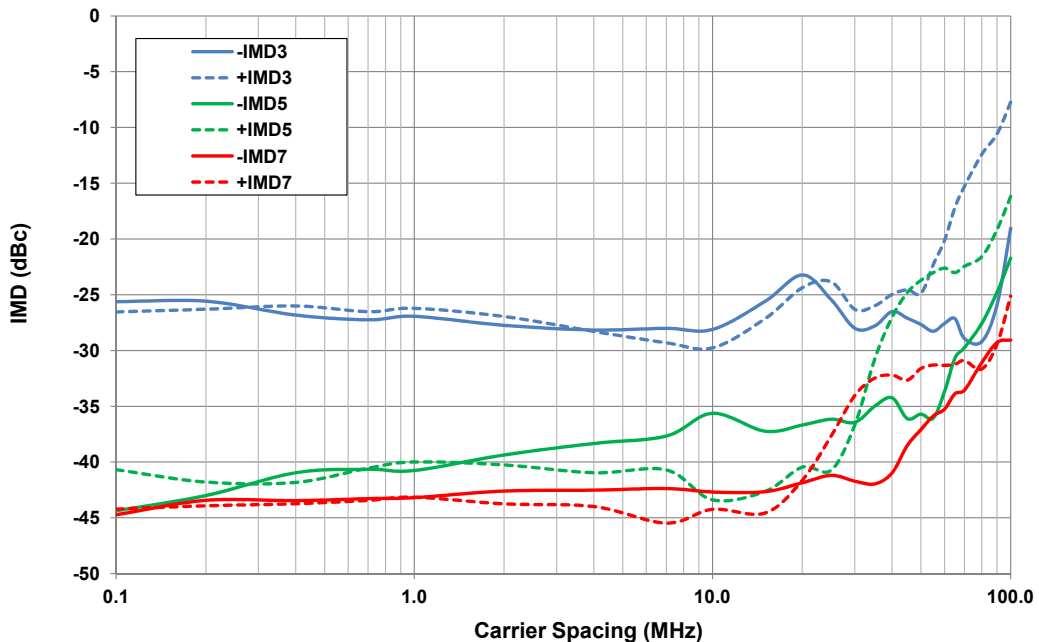

Typical Performance

Figure 9. - Pulsed vs Frequency @ $P_{IN} = 43$ dBm
CGHV50200F in Test Fixture
10% Duty, 100 μ S Pulse Width
 $V_{DD} = 40$ V, $I_{DQ} = 1$ A, $T_{case} = 25^\circ\text{C}$

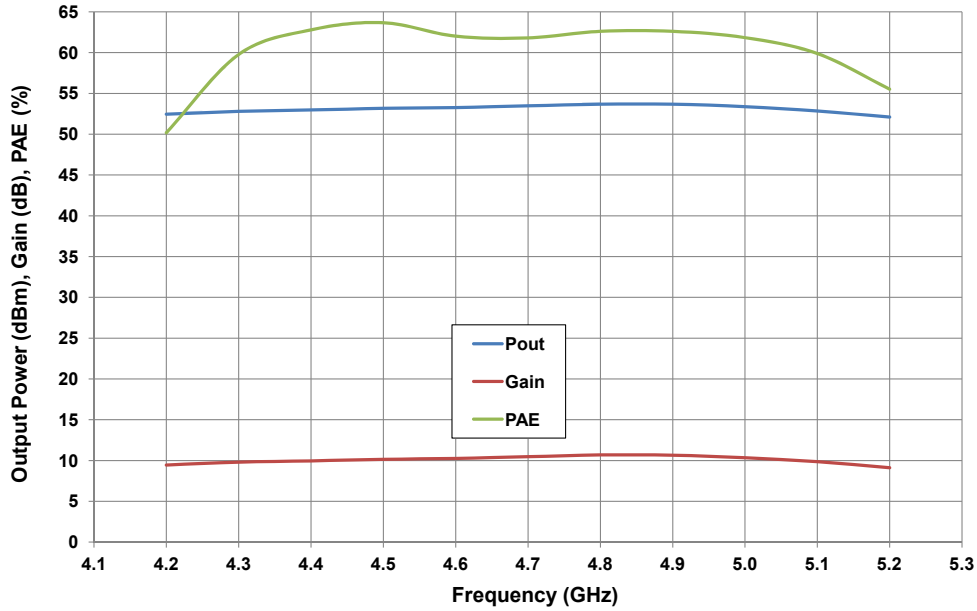
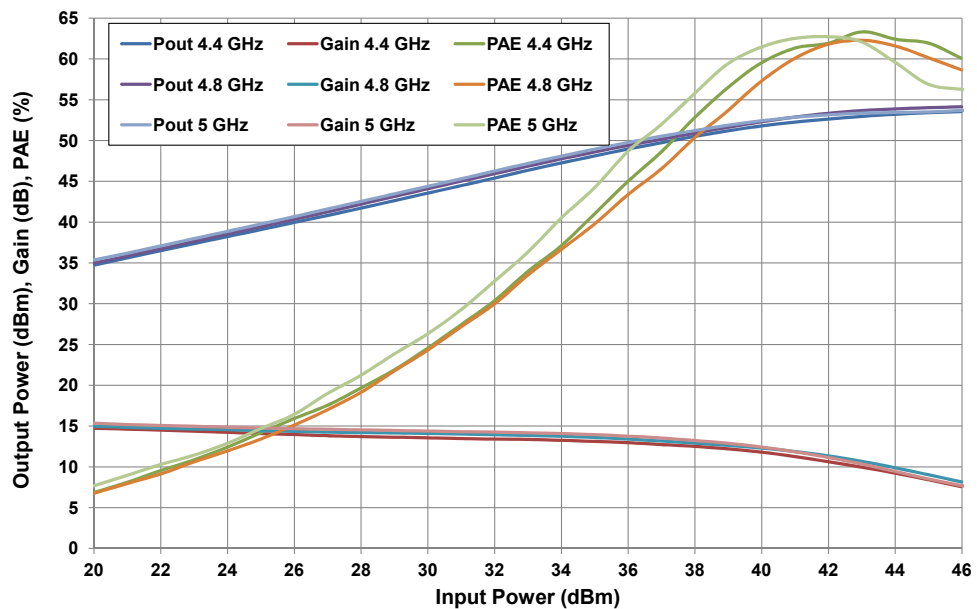

Figure 10. - Pulsed Power Sweep
CGHV50200F in Test Fixture
10% Duty, 100 μ S Pulse Width
 $V_{DD} = 40$ V, $I_{DQ} = 1$ A, $T_{case} = 25^\circ\text{C}$



Typical Performance

Figure 11. - AM-AM
 $V_{DD} = 40\text{ V}$, $I_{DQ} = 1\text{ A}$, $T_{case} = 25^\circ\text{C}$

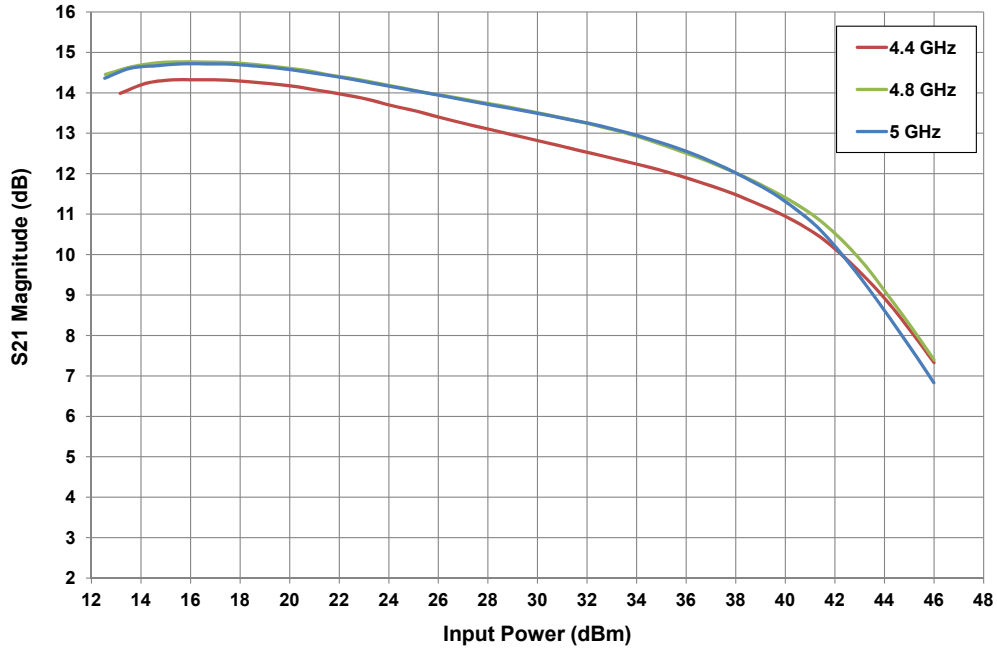
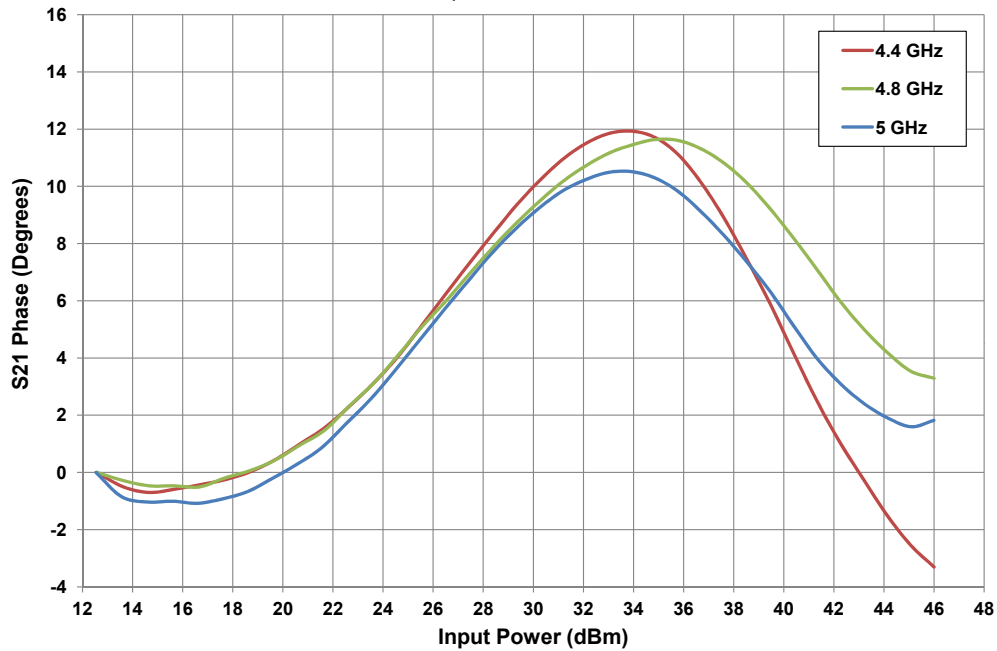
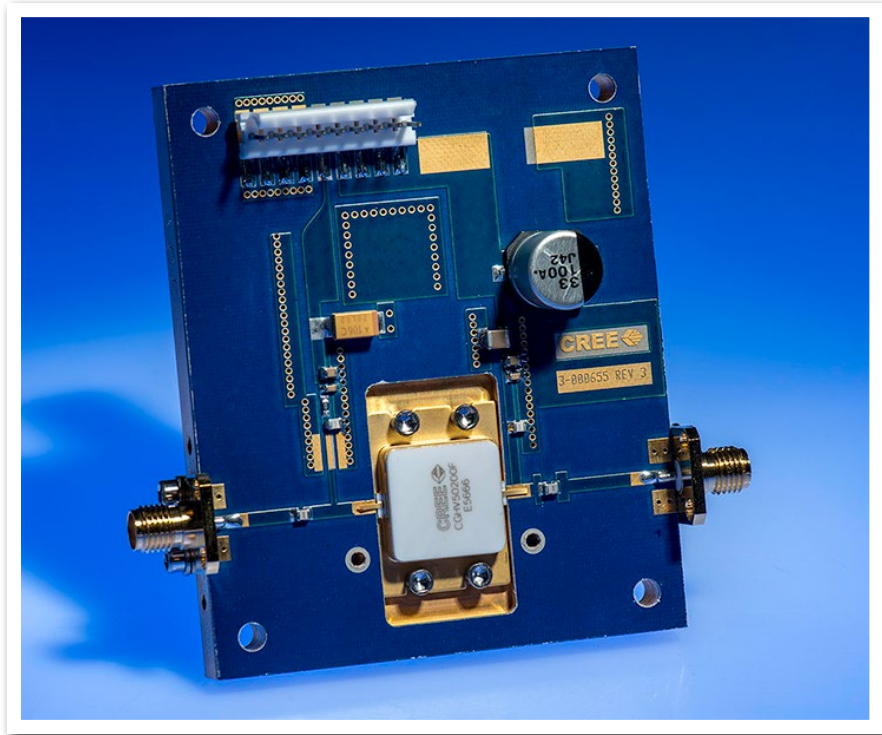

Figure 12. - AM-PM
 $V_{DD} = 40\text{ V}$, $I_{DQ} = 1\text{ A}$, $T_{case} = 25^\circ\text{C}$



CGHV50200F-AMP Demonstration Amplifier Circuit



CGHV50200F-AMP Demonstration Amplifier Circuit Outline

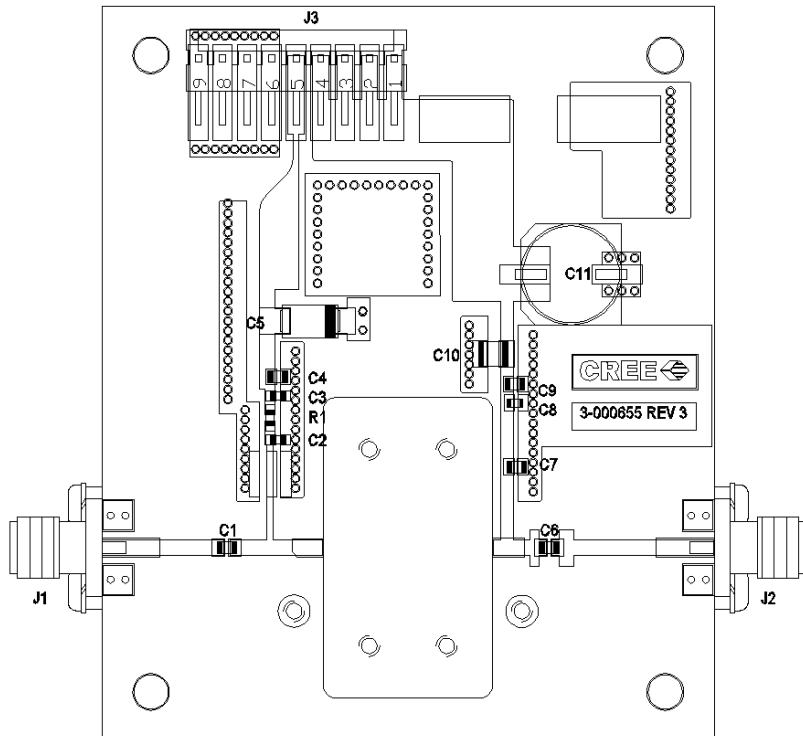

CGHV50200F-AMP Demonstration Amplifier Circuit Schematic

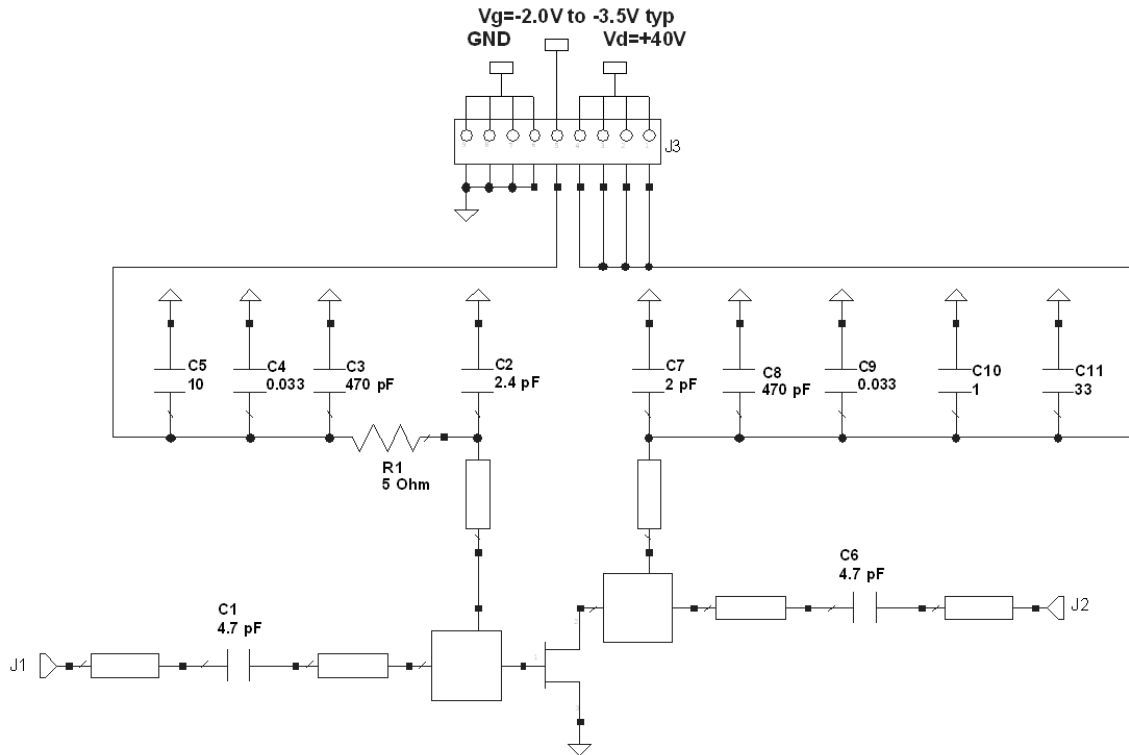

CGHV50200F-AMP Demonstration Amplifier Circuit Bill of Materials

Designator	Description	Qty
R1	RES, 5.1,OHM, +/- 1%, 1/16W,0603	1
C1,C6	CAP, 4.7PF, +/-1%,250V, 0805,	2
C2	CAP, 2.4pF, +/- 0.25 pF,250V, 0603	1
C3,C8	CAP, 470PF, 5%, 100V, 0603, X	2
C4,C9	CAP,33000PF, 0805,100V, X7R	2
C5	CAP 10UF 16V TANTALUM	1
C7	CAP, 2.0PF, +/-1%,250V, 0805,	1
C10	CAP, 1.0UF, 100V, 10%, X7R, 1210	1
C11	CAP, 33 UF, 20%, G CASE	1
J1,J2	CONN, SMA, PANEL MOUNT JACK	2
J3	HEADER RT>PLZ .1CEN LK 9POS	1
-	PCB, RF35, 2.5 X 3.0 X 0.250	1
-	2-56 SOC HD SCREW 1/4 SS	4
-	#2 SPLIT LOCKWASHER SS	4
Q1	CGHV50200F	1

CGHV50200F Power Dissipation De-rating Curve

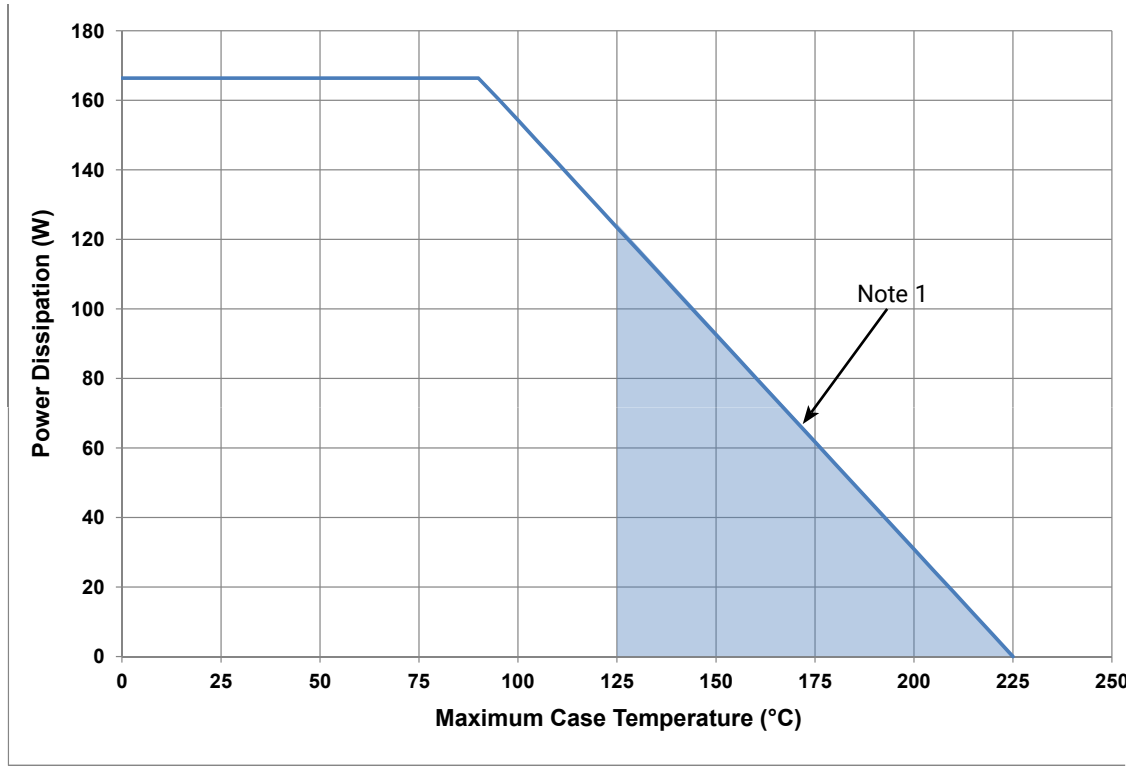

Note 1 : Shaded area exceeds Maximum Case Operating Temperature (See Page 2)

Electrostatic Discharge (ESD) Classifications

Parameter	Symbol	Class	Test Methodology
Human Body Model	HBM	1A (> 250 V)	JEDEC JESD22 A114-D
Charge Device Model	CDM	2 (125 V to 250 V)	JEDEC JESD22 C101-C

Product Dimensions CGHV50200F (Package Type – 440217)

NOTES: (UNLESS OTHERWISE SPECIFIED)

1. INTERPRET DRAWING IN ACCORDANCE WITH ANSI Y14.5M-2009
2. ADHESIVE FROM LID MAY EXTEND A MAXIMUM OF .020 BEYOND EDGE OF LID
3. LID MAY BE MISALIGNED TO THE BODY OF PACKAGE BY A MAXIMUM OF .008 IN ANY DIRECTION
4. ALL PLATED SURFACES ARE GOLD OVER NICKEL

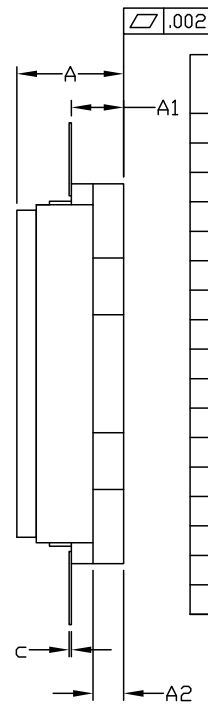
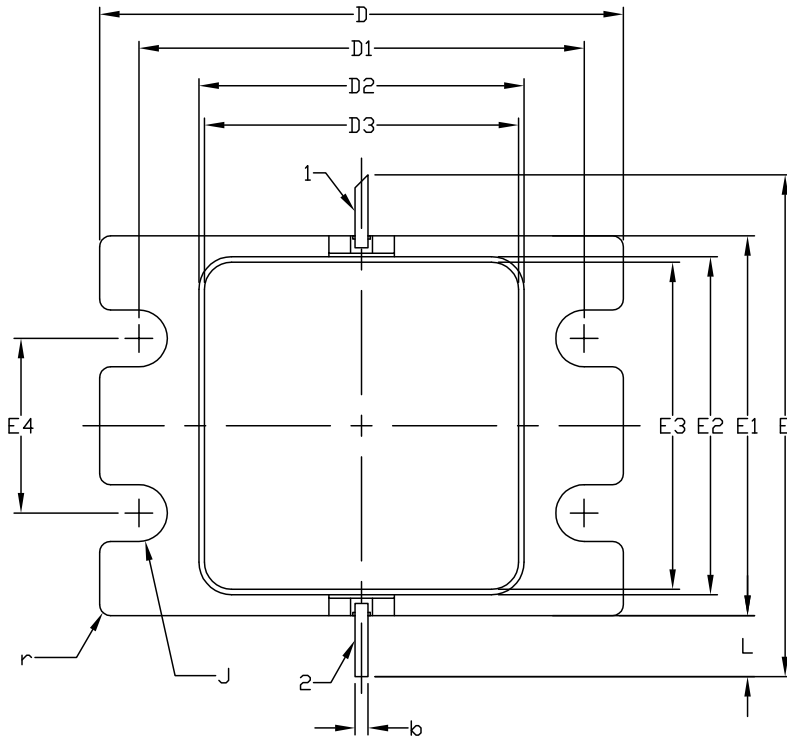

1. GATE
2. DRAIN

DIM	INCHES		MILLIMETERS		NOTES
	MIN	MAX	MIN	MAX	
A	0.188	0.198	4.78	5.03	
A1	0.088	0.100	2.24	2.54	2x
A2	0.049	0.061	1.24	1.55	
b	0.022	0.026	0.56	0.66	2x
c	0.002	0.006	0.05	0.15	
D	0.935	0.955	23.75	24.26	
D1	0.797	0.809	20.24	20.55	2x
D2	0.581	0.593	14.76	15.06	
D3	0.563	0.571	14.30	14.50	
E	0.906		23.01		REF
E1	0.679	0.691	17.25	17.55	
E2	0.604	0.616	15.34	15.65	
E3	0.586	0.594	14.88	15.09	
E4	0.309	0.321	7.85	8.15	2x
J	∅0.097	∅0.107	∅2.46	∅2.72	4x
L	0.090	0.130	2.29	3.30	2x
r	0.02 TYP		0.51 TYP		12x

CGHV50200F

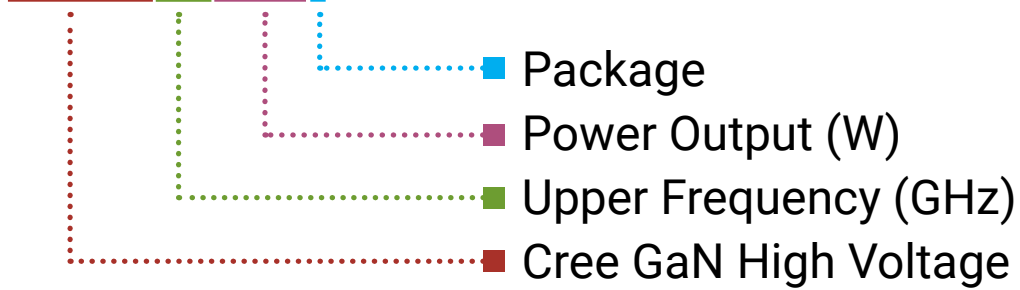

Parameter	Value	Units
Upper Frequency ¹	5.0	GHz
Power Output	200	W
Package	Flange	-

Table 1.

Note¹: Alpha characters used in frequency code indicate a value greater than 9.9 GHz. See Table 2 for value.

Character Code	Code Value
A	0
B	1
C	2
D	3
E	4
F	5
G	6
H	7
J	8
K	9
Examples:	1A = 10.0 GHz 2H = 27.0 GHz

Table 2.

Product Ordering Information

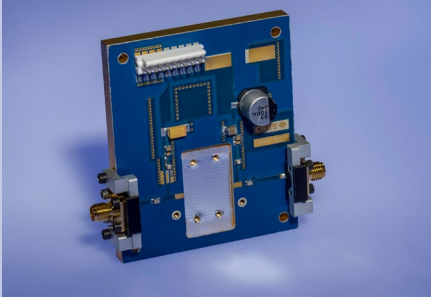
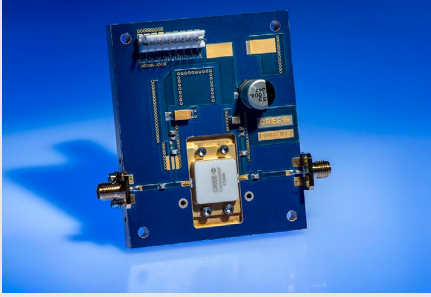
Order Number	Description	Unit of Measure	Image
CGHV50200F	GaN HEMT	Each	
CGHV50200F-TB	Test board without GaN HEMT	Each	
CGHV50200F-AMP	Test board with GaN HEMT installed	Each	



Disclaimer

Specifications are subject to change without notice. Cree, Inc. believes the information contained within this data sheet to be accurate and reliable. However, no responsibility is assumed by Cree for any infringement of patents or other rights of third parties which may result from its use. No license is granted by implication or otherwise under any patent or patent rights of Cree. Cree makes no warranty, representation or guarantee regarding the suitability of its products for any particular purpose. "Typical" parameters are the average values expected by Cree in large quantities and are provided for information purposes only. These values can and do vary in different applications and actual performance can vary over time. All operating parameters should be validated by customer's technical experts for each application. Cree products are not designed, intended or authorized for use as components in applications intended for surgical implant into the body or to support or sustain life, in applications in which the failure of the Cree product could result in personal injury or death or in applications for planning, construction, maintenance or direct operation of a nuclear facility.

For more information, please contact:

Cree, Inc.
4600 Silicon Drive
Durham, North Carolina, USA 27703
www.cree.com/rf

Sarah Miller
Marketing
Cree, RF Components
1.919.407.5302

Ryan Baker
Marketing & Sales
Cree, RF Components
1.919.407.7816

Tom Dekker
Sales Director
Cree, RF Components
1.919.407.5639