

High Efficiency LED in \varnothing 5 mm Tinted Diffused Package

Description

The TLH.54.. series was developed for standard applications like general indicating and lighting purposes.

It is housed in a 5 mm tinted diffused plastic package. The wide viewing angle of these devices provides a high on-off contrast.

Several selection types with different luminous intensities are offered. All LEDs are categorized in luminous intensity groups. The green and yellow LEDs are categorized additionally in wavelength groups.

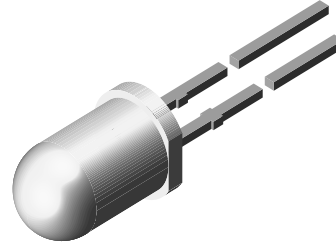

19223



That allows users to assemble LEDs with uniform appearance.

Features

- Choice of three bright colors
- Standard T-1 $\frac{3}{4}$ package
- Small mechanical tolerances
- Suitable for DC and high peak current
- Wide viewing angle
- Luminous intensity categorized
- Yellow and green color categorized
- TLH.54.. with stand-offs
- Lead-free device

Applications

- Status lights
- OFF / ON indicator
- Background illumination
- Readout lights
- Maintenance lights
- Legend light

Parts Table

Part	Color, Luminous Intensity	Angle of Half Intensity ($\pm\phi$)	Technology
TLHR5400	Red, $I_V = 3.5$ mcd (typ.)	30 °	GaAsP on GaP
TLHR5401	Red, $I_V = 7$ mcd (typ.)	30 °	GaAsP on GaP
TLHR5405	Red, $I_V = 10$ mcd (typ.)	30 °	GaAsP on GaP
TLHY5400	Yellow, $I_V = 3.5$ mcd (typ.)	30 °	GaAsP on GaP
TLHY5401	Yellow, $I_V = 7$ mcd (typ.)	30 °	GaAsP on GaP
TLHY5405	Yellow, $I_V = 10$ mcd (typ.)	30 °	GaAsP on GaP
TLHG5400	Green, $I_V = 4$ mcd (typ.)	30 °	GaP on GaP
TLHG5401	Green, $I_V = 7$ mcd (typ.)	30 °	GaP on GaP
TLHG5405	Green, $I_V = 15$ mcd (typ.)	30 °	GaP on GaP

Absolute Maximum Ratings

$T_{amb} = 25\text{ }^{\circ}\text{C}$, unless otherwise specified

TLHR54.., TLHY54.., TLHG54.., TLHG54..,

Parameter	Test condition	Symbol	Value	Unit
Reverse voltage		V_R	6	V
DC Forward current	$T_{amb} \leq 65\text{ }^{\circ}\text{C}$	I_F	30	mA
Surge forward current	$t_p \leq 10\text{ }\mu\text{s}$	I_{FSM}	1	A
Power dissipation	$T_{amb} \leq 65\text{ }^{\circ}\text{C}$	P_V	100	mW
Junction temperature		T_j	100	$^{\circ}\text{C}$
Operating temperature range		T_{amb}	- 20 to + 100	$^{\circ}\text{C}$
Storage temperature range		T_{stg}	- 55 to + 100	$^{\circ}\text{C}$
Soldering temperature	$t \leq 5\text{ s}$, 2 mm from body	T_{sd}	260	$^{\circ}\text{C}$
Thermal resistance junction/ ambient		R_{thJA}	350	K/W

Optical and Electrical Characteristics

$T_{amb} = 25\text{ }^{\circ}\text{C}$, unless otherwise specified

Red

TLHR54..

Parameter	Test condition	Part	Symbol	Min	Typ.	Max	Unit
Luminous intensity ¹⁾	$I_F = 10\text{ mA}$	TLHR5400	I_V	1.6	3.5		mcd
		TLHR5401	I_V	4	7		mcd
		TLHR5405	I_V	6.3	10		mcd
Dominant wavelength	$I_F = 10\text{ mA}$		λ_d	612		625	nm
Peak wavelength	$I_F = 10\text{ mA}$		λ_p		635		nm
Angle of half intensity	$I_F = 10\text{ mA}$		φ		± 30		deg
Forward voltage	$I_F = 20\text{ mA}$		V_F		2	3	V
Reverse voltage	$I_R = 10\text{ }\mu\text{A}$		V_R	6	15		V
Junction capacitance	$V_R = 0$, $f = 1\text{ MHz}$		C_j		50		pF

¹⁾ in one Packing Unit $I_{Vmin}/I_{Vmax} \leq 0.5$

Yellow

TLHY54..

Parameter	Test condition	Part	Symbol	Min	Typ.	Max	Unit
Luminous intensity ¹⁾	$I_F = 10\text{ mA}$	TLHY5400	I_V	1.6	3.5		mcd
		TLHY5401	I_V	4	7		mcd
		TLHY5401	I_V	6.3	10		mcd
Dominant wavelength	$I_F = 10\text{ mA}$		λ_d	581		594	nm
Peak wavelength	$I_F = 10\text{ mA}$		λ_p		585		nm
Angle of half intensity	$I_F = 10\text{ mA}$		φ		± 30		deg
Forward voltage	$I_F = 20\text{ mA}$		V_F		2.4	3	V
Reverse voltage	$I_R = 10\text{ }\mu\text{A}$		V_R	6	15		V
Junction capacitance	$V_R = 0$, $f = 1\text{ MHz}$		C_j		50		pF

¹⁾ in one Packing Unit $I_{Vmin}/I_{Vmax} \leq 0.5$

Green

TLHG54..

Parameter	Test condition	Part	Symbol	Min	Typ.	Max	Unit
Luminous intensity ¹⁾	$I_F = 10 \text{ mA}$	TLHG5400	I_V	1.6	4		mcd
		TLHG5401	I_V	4	7		mcd
		TLHG5405	I_V	6.3	15		mcd
Dominant wavelength	$I_F = 10 \text{ mA}$		λ_d	562		575	nm
Peak wavelength	$I_F = 10 \text{ mA}$		λ_p		565		nm
Angle of half intensity	$I_F = 10 \text{ mA}$		ϕ		± 30		deg
Forward voltage	$I_F = 20 \text{ mA}$		V_F		2.4	3	V
Reverse voltage	$I_R = 10 \mu\text{A}$		V_R	6	15		V
Junction capacitance	$V_R = 0, f = 1 \text{ MHz}$		C_j		50		pF

¹⁾ in one Packing Unit $I_{Vmin}/I_{Vmax} \leq 0.5$

Typical Characteristics ($T_{amb} = 25 \text{ }^\circ\text{C}$ unless otherwise specified)

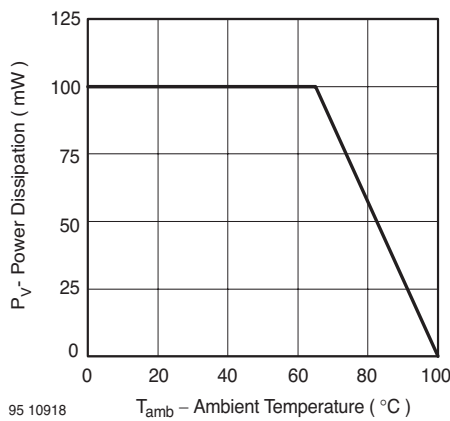

Figure 1. Power Dissipation vs. Ambient Temperature



Figure 3. Forward Current vs. Pulse Length

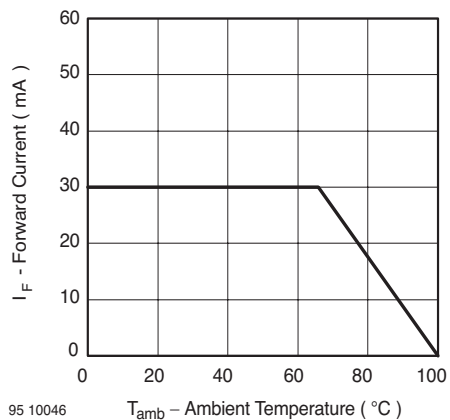

Figure 2. Forward Current vs. Ambient Temperature

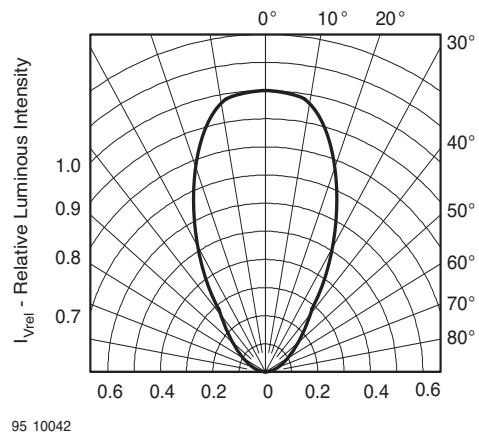

Figure 4. Rel. Luminous Intensity vs. Angular Displacement

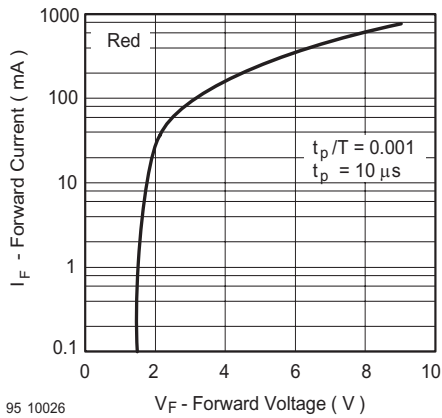

Figure 5. Forward Current vs. Forward Voltage

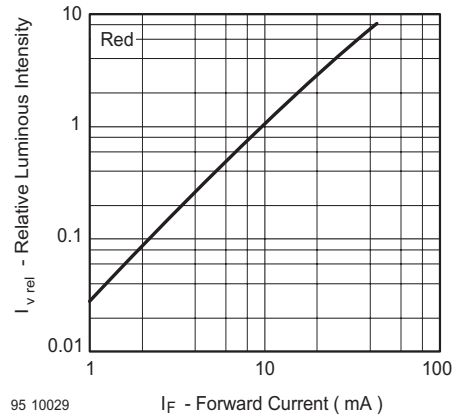

Figure 8. Relative Luminous Intensity vs. Forward Current

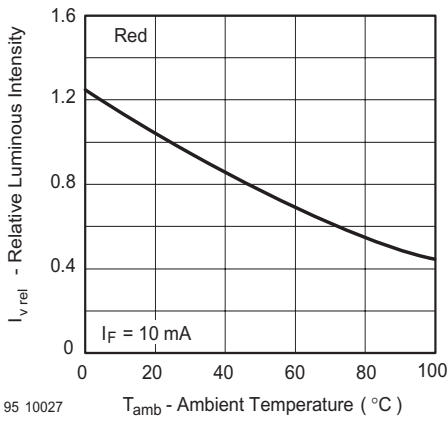

Figure 6. Rel. Luminous Intensity vs. Ambient Temperature

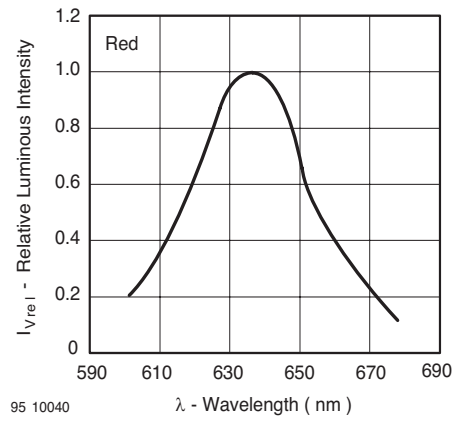

Figure 9. Relative Intensity vs. Wavelength

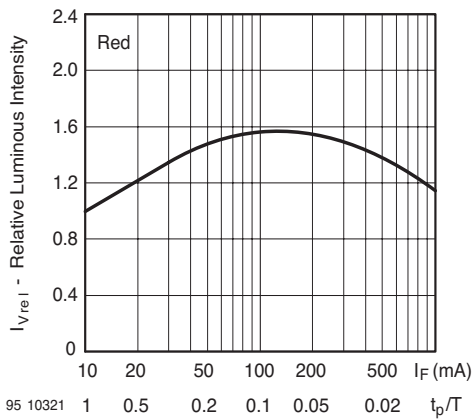

Figure 7. Rel. Lumin. Intensity vs. Forw. Current/Duty Cycle

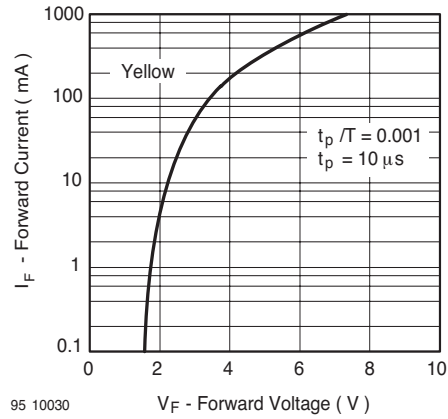

Figure 10. Forward Current vs. Forward Voltage



Figure 11. Rel. Luminous Intensity vs. Ambient Temperature



Figure 14. Relative Intensity vs. Wavelength

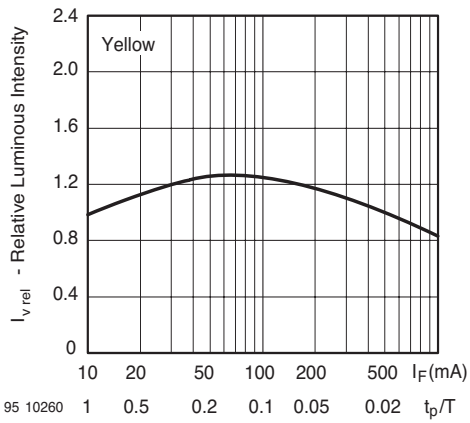

Figure 12. Rel. Lumin. Intensity vs. Forw. Current/Duty Cycle

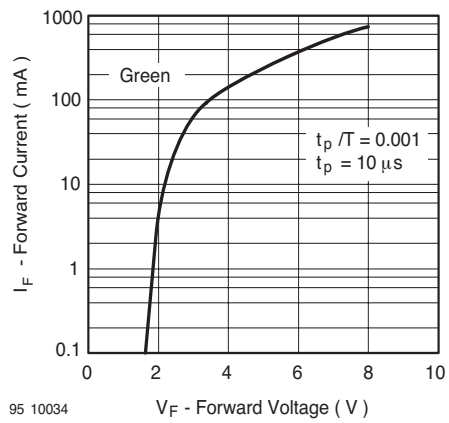

Figure 15. Forward Current vs. Forward Voltage

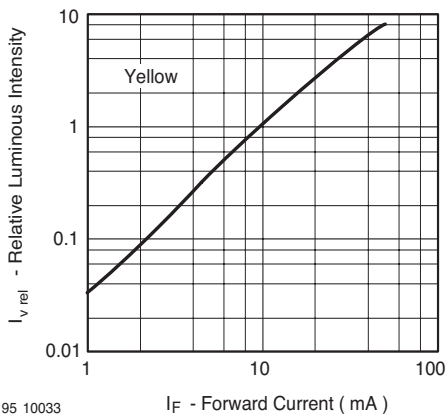

Figure 13. Relative Luminous Intensity vs. Forward Current

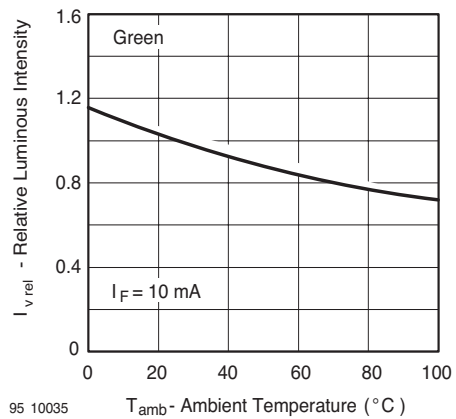

Figure 16. Rel. Luminous Intensity vs. Ambient Temperature

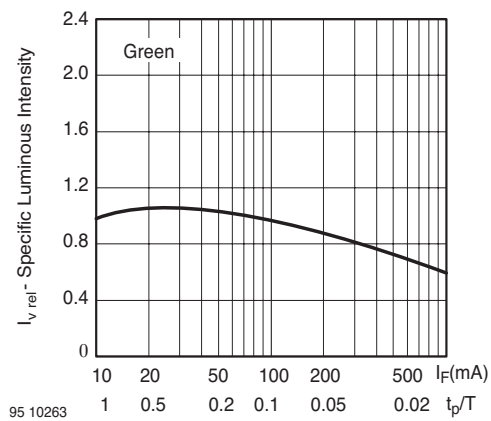

Figure 17. Specific Luminous Intensity vs. Forward Current

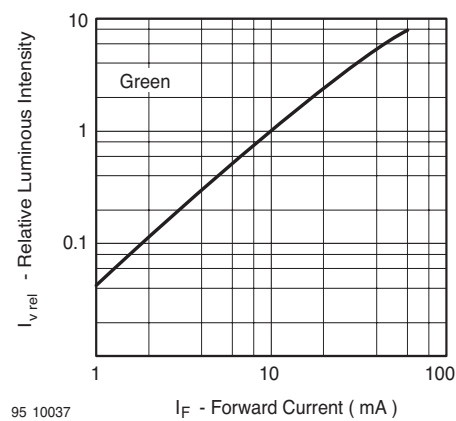

Figure 18. Relative Luminous Intensity vs. Forward Current

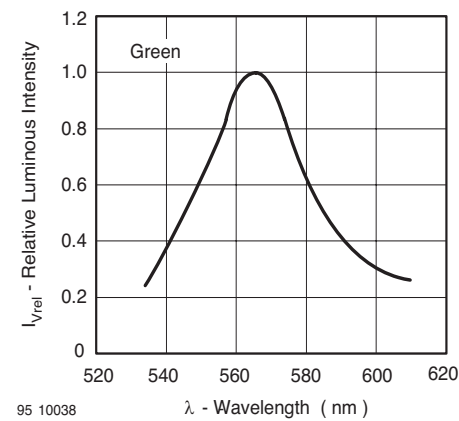
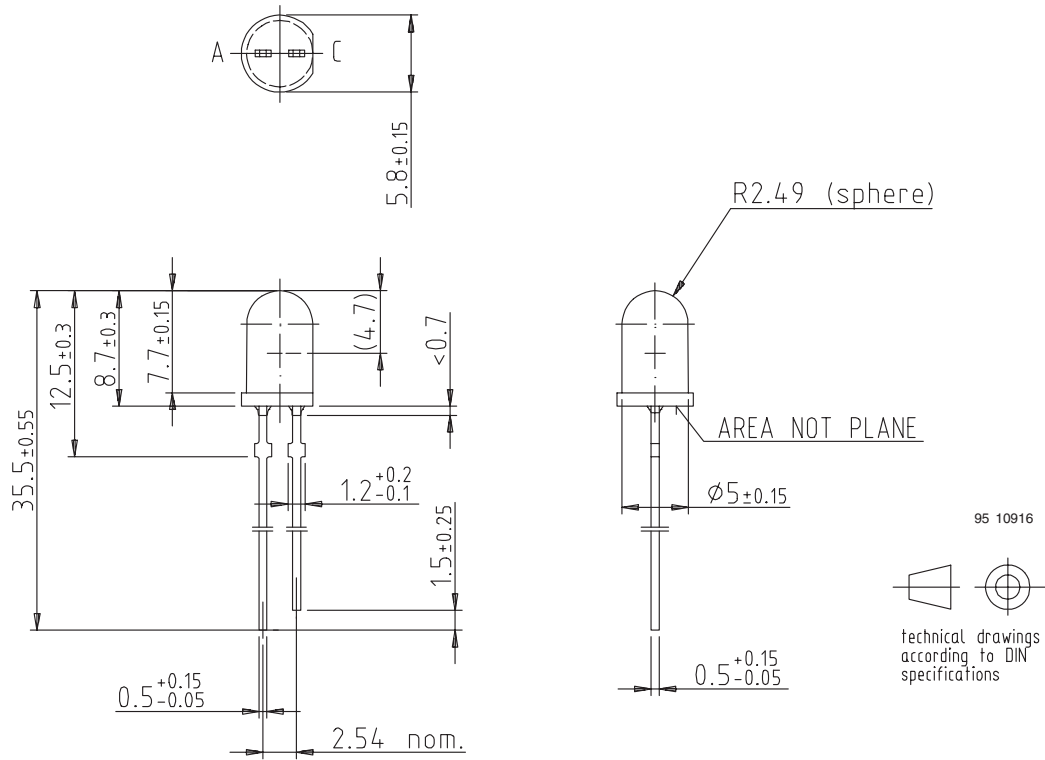

Figure 19. Relative Intensity vs. Wavelength

Package Dimensions in mm



Vishay Semiconductors

Ozone Depleting Substances Policy Statement

It is the policy of **Vishay Semiconductor GmbH** to

1. Meet all present and future national and international statutory requirements.
2. Regularly and continuously improve the performance of our products, processes, distribution and operating systems with respect to their impact on the health and safety of our employees and the public, as well as their impact on the environment.

It is particular concern to control or eliminate releases of those substances into the atmosphere which are known as ozone depleting substances (ODSs).

The Montreal Protocol (1987) and its London Amendments (1990) intend to severely restrict the use of ODSs and forbid their use within the next ten years. Various national and international initiatives are pressing for an earlier ban on these substances.

Vishay Semiconductor GmbH has been able to use its policy of continuous improvements to eliminate the use of ODSs listed in the following documents.

1. Annex A, B and list of transitional substances of the Montreal Protocol and the London Amendments respectively
2. Class I and II ozone depleting substances in the Clean Air Act Amendments of 1990 by the Environmental Protection Agency (EPA) in the USA
3. Council Decision 88/540/EEC and 91/690/EEC Annex A, B and C (transitional substances) respectively.

Vishay Semiconductor GmbH can certify that our semiconductors are not manufactured with ozone depleting substances and do not contain such substances.

**We reserve the right to make changes to improve technical design
and may do so without further notice.**

Parameters can vary in different applications. All operating parameters must be validated for each customer application by the customer. Should the buyer use Vishay Semiconductors products for any unintended or unauthorized application, the buyer shall indemnify Vishay Semiconductors against all claims, costs, damages, and expenses, arising out of, directly or indirectly, any claim of personal damage, injury or death associated with such unintended or unauthorized use.

Vishay Semiconductor GmbH, P.O.B. 3535, D-74025 Heilbronn, Germany
Telephone: 49 (0)7131 67 2831, Fax number: 49 (0)7131 67 2423