

PMN 5000 series  
DC/DC regulator, Input 4.5-5.5 V, Output 30 A/108 W

EN/LZT 146 386 R1B Oct 2011

© Ericsson Power Modules AB

**Key Features**

- Industry standard POLA™ compatible  
34.8 x 15.75 x 8.5 mm (1.37 x 0.62 x 0.335 in)
- High efficiency, up to 96%
- Auto Track™ sequencing pin
- Turbo Trans™ Technology for Ultra-Fast Transient
- MTBF 4.6 Mh

General Characteristics

- Operating temperature: -40°C to 85°C
- Input under voltage protection
- Start up into a pre-biased output
- Output short-circuit protection
- On/Off inhibit control
- Wide input voltage function
- Wide output voltage adjust function
- Highly automated manufacturing ensures quality
- ISO 9001/14001 certified supplier

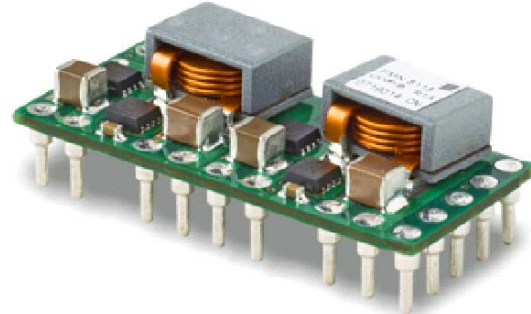

Safety Approvals



Design for Environment



Meets requirements in high-temperature lead-free soldering processes.

**Contents**

Ordering Information	2
General Information	2
Safety Specification	3
Absolute Maximum Ratings	4
Product Program	Ordering No.
0.7-3.6V, 30A / 108W	PMN 5118U P.....
0.7V, 30A / 21W Electrical Specification	5
1.0V, 30A / 30W Electrical Specification	8
1.2V, 30A / 36W Electrical Specification	11
1.5V, 30A / 45W Electrical Specification	14
1.8V, 30A / 54W Electrical Specification	17
2.5V, 30A / 75W Electrical Specification	20
3.3V, 30A / 99W Electrical Specification	23
EMC Specification	26
Operating Information	26
Thermal Consideration	30
Connections	31
Mechanical Information	33
Soldering Information	35
Delivery Information	36
Product Qualification Specification	37

PMN 5000 series  
DC/DC regulator, Input 4.5-5.5 V, Output 30 A/108 W

EN/LZT 146 386 R1B Oct 2011

© Ericsson Power Modules AB

### Ordering Information

Product program	Output
PMN 5118U P	0.7-3.6 V, 30 A /108 W

#### Product number and Packaging

PMN 5118UW P n <sub>1</sub> n <sub>2</sub>				
Options	n <sub>1</sub>	n <sub>2</sub>		
SMD pin	o			
SMD pin with lead-free surface		o		

Options	Description
n <sub>1</sub>	P Through-hole * S SMD pin
n <sub>2</sub>	SR SMD pin with lead-free surface

Example a SMD pin with lead-free surface, PMN 5118U SR

\* Standard variant (i.e. no option selected).

### General Information

#### Reliability

The failure rate ( $\lambda$ ) and mean time between failures (MTBF=  $1/\lambda$ ) is calculated at max output power and an operating ambient temperature ( $T_A$ ) of +40°C. Ericsson Power Modules uses Telcordia SR-332 Issue 2 Method 1 to calculate the mean steady-state failure rate and standard deviation ( $\sigma$ ).

Telcordia SR-332 Issue 2 also provides techniques to estimate the upper confidence levels of failure rates based on the mean and standard deviation.

Mean steady-state failure rate, $\lambda$	Std. deviation, $\sigma$
167 nFailures/h	41 nFailures/h

MTBF (mean value) for the PMN series = 6 Mh.

MTBF at 90% confidence level = 4.6 Mh

#### Compatibility with RoHS requirements

The products are compatible with the relevant clauses and requirements of the RoHS directive 2011/65/EU and have a maximum concentration value of 0.1% by weight in homogeneous materials for lead, mercury, hexavalent chromium, PBB and PBDE and of 0.01% by weight in homogeneous materials for cadmium.

Exemptions in the RoHS directive utilized in Ericsson Power Modules products are found in the Statement of Compliance document.

Ericsson Power Modules fulfills and will continuously fulfill all its obligations under regulation (EC) No 1907/2006 concerning the registration, evaluation, authorization and restriction of chemicals (REACH) as they enter into force and is through product materials declarations preparing for the obligations to communicate information on substances in the products.

#### Quality Statement

The products are designed and manufactured in an industrial environment where quality systems and methods like ISO 9000, Six Sigma, and SPC are intensively in use to boost the continuous improvements strategy. Infant mortality or early failures in the products are screened out and they are subjected to an ATE-based final test. Conservative design rules, design reviews and product qualifications, plus the high competence of an engaged work force, contribute to the high quality of the products.

#### Warranty

Warranty period and conditions are defined in Ericsson Power Modules General Terms and Conditions of Sale.

#### Limitation of Liability

Ericsson Power Modules does not make any other warranties, expressed or implied including any warranty of merchantability or fitness for a particular purpose (including, but not limited to, use in life support applications, where malfunctions of product can cause injury to a person's health or life).

#### © Ericsson AB 2011

The information and specifications in this technical specification is believed to be correct at the time of publication. However, no liability is accepted for inaccuracies, printing errors or for any consequences thereof. Ericsson AB reserves the right to change the contents of this technical specification at any time without prior notice.

PMN 5000 series  
DC/DC regulator, Input 4.5-5.5 V, Output 30 A/108 W

EN/LZT 146 386 R1B Oct 2011

© Ericsson Power Modules AB

## Safety Specification

### General information

Ericsson Power Modules DC/DC converters and DC/DC regulators are designed in accordance with the safety standards IEC 60950-1, EN 60950-1 and UL 60950-1 *Safety of Information Technology Equipment*.

IEC/EN/UL 60950-1 contains requirements to prevent injury or damage due to the following hazards:

- Electrical shock
- Energy hazards
- Fire
- Mechanical and heat hazards
- Radiation hazards
- Chemical hazards

On-board DC/DC converters and DC/DC regulators are defined as component power supplies. As components they cannot fully comply with the provisions of any safety requirements without “conditions of acceptability”. Clearance between conductors and between conductive parts of the component power supply and conductors on the board in the final product must meet the applicable safety requirements. Certain conditions of acceptability apply for component power supplies with limited stand-off (see Mechanical Information for further information). It is the responsibility of the installer to ensure that the final product housing these components complies with the requirements of all applicable safety standards and regulations for the final product.

Component power supplies for general use should comply with the requirements in IEC/EN/UL 60950-1 *Safety of Information Technology Equipment*. Product related standards, e.g. IEEE 802.3af *Power over Ethernet*, and ETS-300132-2 *Power interface at the input to telecom equipment, operated by direct current (dc)* are based on IEC/EN/UL 60950-1 with regards to safety.

Ericsson Power Modules DC/DC converters and DC/DC regulators are UL 60950-1 recognized and certified in accordance with EN 60950-1. The flammability rating for all construction parts of the products meet requirements for V-0 class material according to IEC 60695-11-10, *Fire hazard testing, test flames – 50 W horizontal and vertical flame test methods*.

### Isolated DC/DC converters

Galvanic isolation between input and output is verified in an electric strength test and the isolation voltage ( $V_{iso}$ ) meets the voltage strength requirement for basic insulation according to IEC/EN/UL 60950-1.

It is recommended to use a slow blow fuse at the input of each DC/DC converter. If an input filter is used in the circuit the fuse should be placed in front of the input filter. In the rare event of a component problem that imposes a short

circuit on the input source, this fuse will provide the following functions:

- Isolate the fault from the input power source so as not to affect the operation of other parts of the system
- Protect the distribution wiring from excessive current and power loss thus preventing hazardous overheating

The DC/DC converter output is considered as safety extra low voltage (SELV) if one of the following conditions is met:

- The input source has double or reinforced insulation from the AC mains according to IEC/EN/UL 60950-1
- The input source has basic or supplementary insulation from the AC mains and the input of the DC/DC converter is maximum 60 Vdc and connected to protective earth according to IEC/EN/UL 60950-1
- The input source has basic or supplementary insulation from the AC mains and the DC/DC converter output is connected to protective earth according to IEC/EN/UL 60950-1

### Non-isolated DC/DC regulators

The DC/DC regulator output is SELV if the input source meets the requirements for SELV circuits according to IEC/EN/UL 60950-1.

PMN 5000 series  
DC/DC regulator, Input 4.5-5.5 V, Output 30 A/108 W

EN/LZT 146 386 R1B Oct 2011

© Ericsson Power Modules AB

**Absolute Maximum Ratings**

Characteristics		min	typ	max	Unit
$T_{ref}$	Operating Temperature (see Thermal Consideration section)	-40		85	°C
$T_S$	Storage temperature	-40		125	°C
$V_I$	Input voltage	4.5	5	5.5	V
$V_{RC}$	Remote Control pin voltage (see Operating Information section)	Positive logic option	$V_{in}-0.5$	Open	V
		Negative logic option	N/A	N/A	V
$V_{adj}$	Adjust pin voltage (see Operating Information section)	N/A		N/A	V

Stress in excess of Absolute Maximum Ratings may cause permanent damage. Absolute Maximum Ratings, sometimes referred to as no destruction limits, are normally tested with one parameter at a time exceeding the limits of Output data or Electrical Characteristics. If exposed to stress above these limits, function and performance may degrade in an unspecified manner.

**Fundamental Circuit Diagram**

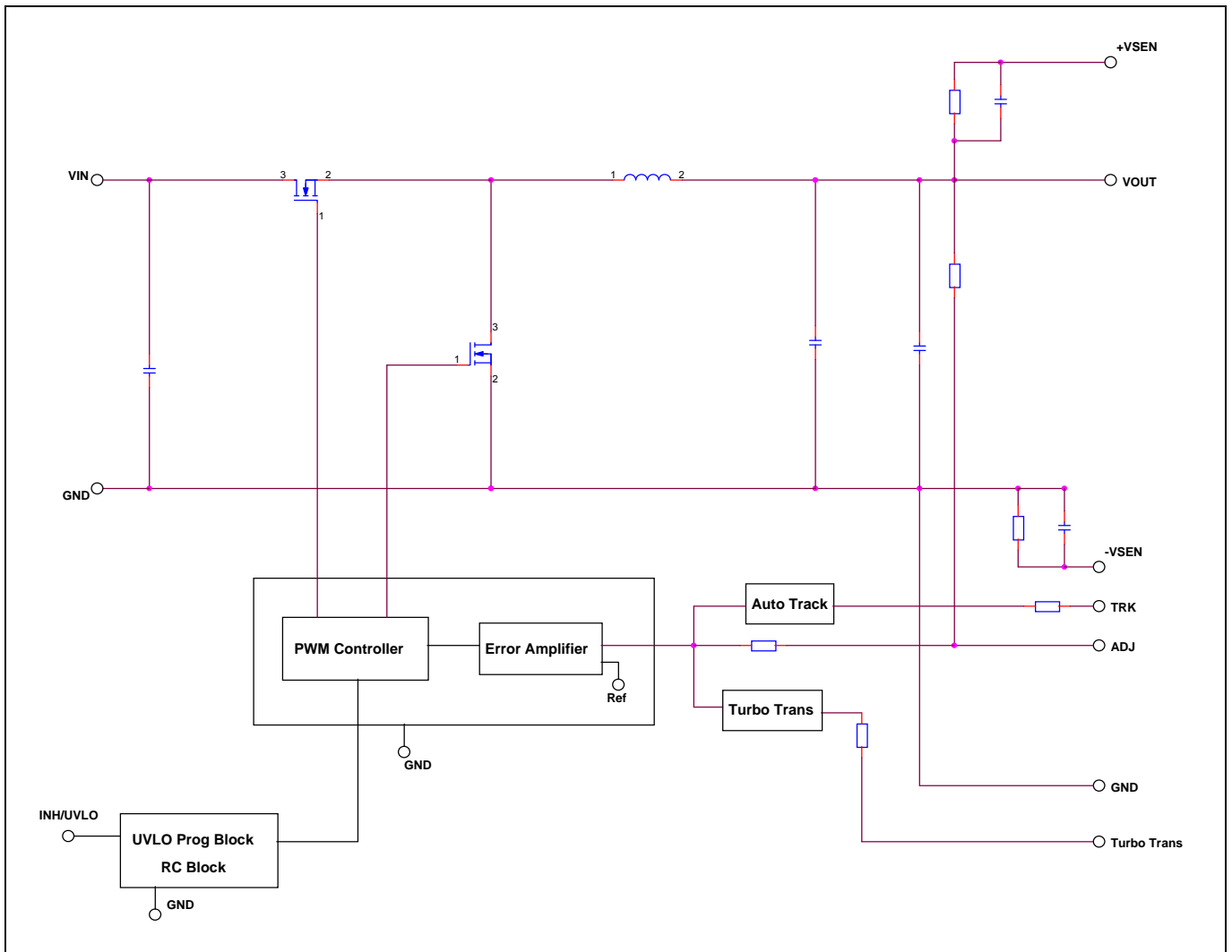

PMN 5000 series DC/DC regulator, Input 4.5-5.5 V, Output 30 A/108 W	EN/LZT 146 386 R1B Oct 2011
	© Ericsson Power Modules AB

**0.7V, 30A / 21W Electrical Specification**
**PMN 5118U P**

$T_{ref} = -40$  to  $+85^{\circ}\text{C}$ ,  $V_I = 4.5$  to  $5.5$  V,  $R_{adj} = \text{OPEN}$ , unless otherwise specified under Conditions.

Typical values given at:  $T_{ref} = +25^{\circ}\text{C}$ ,  $V_I = 5$  V, max  $I_O$ , unless otherwise specified under Conditions.

Additional  $C_{in} = 1000$   $\mu\text{F}$  and  $C_{out} = 470$   $\mu\text{F}$ . See Operating Information section for selection of capacitor types.

Connect the sense pin, where available, to the output pin.

Characteristics		Conditions	min	typ	max	Unit
$V_I$	Input voltage range		4.5	5.0	5.5	V
$V_{loff}$	Turn-off input voltage	Decreasing input voltage	3.9	4.1		V
$V_{lon}$	Turn-on input voltage	Increasing input voltage		4.3	4.4	V
$C_I$	Internal input capacitance			94		$\mu\text{F}$
$P_O$	Output power		0		21	W
$\eta$	Efficiency	50 % of max $I_O$		86.6		%
		max $I_O$		79.5		
$P_d$	Power Dissipation	max $I_O$		5.4	5.9	W
$P_{li}$	Input idling power	$I_O = 0$ A, $V_I = 5$ V		0.26		W
$P_{RC}$	Input standby power	$V_I = 5$ V (turned off with RC)		14.1		mW
$I_s$	Static Input current	$V_I = 5$ V, max $I_O$		5.3		A
$f_s$	Switching frequency	0-100 % of max $I_O$	600	640	680	kHz

$V_{Oi}$	Output voltage initial setting and accuracy	$T_{ref} = +25^{\circ}\text{C}$ , $V_I = 5$ V, max $I_O$	0.686	0.700	0.714	V
$V_O$	Output voltage tolerance band	10-100 % of max $I_O$	0.679		0.721	V
	Idling voltage	$I_O = 0$ A		0.703		V
	Line regulation	max $I_O$		$\pm 4$		mV
	Load regulation	$V_I = 5$ V, 0-100 % of max $I_O$		$\pm 7$		mV
$V_{tr}$	Load transient voltage deviation	$V_I = 5$ V, Load step 25-75-25 % of max $I_O$ , $di/dt = 2.5$ A/ $\mu\text{s}$		$\pm 130$		mV
$t_{tr}$	Load transient recovery time	Without Turbo Trans $C_O = 820$ $\mu\text{F}$ Type C		50		$\mu\text{s}$
$V_{tr}$	Load transient voltage deviation	$V_I = 5$ V, Load step 25-75-25 % of max $I_O$ , $di/dt = 2.5$ A/ $\mu\text{s}$		$\pm 90$		mV
$t_{tr}$	Load transient recovery time	With Turbo Trans $C_O = 820$ $\mu\text{F}$ Type C; $R_{TT} = 24$ k $\Omega$		45		$\mu\text{s}$
$t_r$	Ramp-up time (from 10-90 % of $V_O$ )	100 % of max $I_O$		8.3		ms
$t_s$	Start-up time (from $V_I$ connection to 90 % of $V_O$ )			15.0		ms
$t_f$	$V_I$ shut-down fall time. (From $V_I$ off to 10 % of $V_O$ )	Max $I_O$		1.8		ms
		$I_O = 0.1$ A		5.8		ms
$t_{RC}$ $t_{inh}$	RC start-up time	Max $I_O$		16.6		ms
	RC shut-down fall time (From RC off to 10 % of $V_O$ )	Max $I_O$		0.2		ms
		$I_O = 0.1$ A		0.4		ms
$I_O$	Output current		0		30	A
$I_{lim}$	Current limit threshold	$T_{ref} < \max T_{ref}$		68		A
$I_{sc}$	Short circuit current	$T_{ref} = 25^{\circ}\text{C}$		68		A
$V_{Oac}$	Output ripple & noise	See ripple & noise section, max $I_O$		3.0		mVp-p

PMN 5000 series  
DC/DC regulator, Input 4.5-5.5 V, Output 30 A/108 W

EN/LZT 146 386 R1B Oct 2011

© Ericsson Power Modules AB

**0.7V, 30A / 21W Typical Characteristics**

**PMN 5118U P**

**Efficiency**

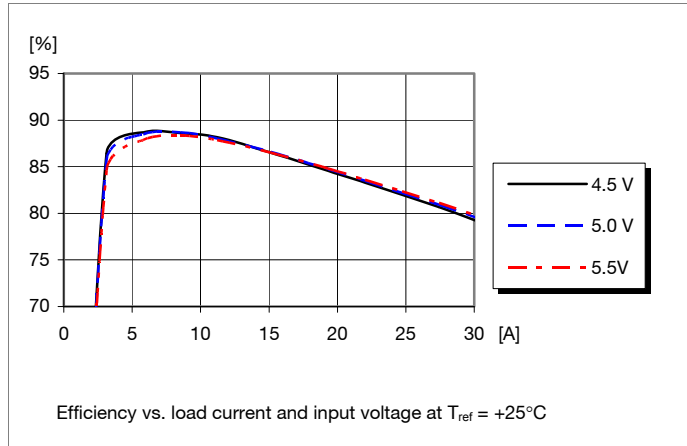

**Power Dissipation**

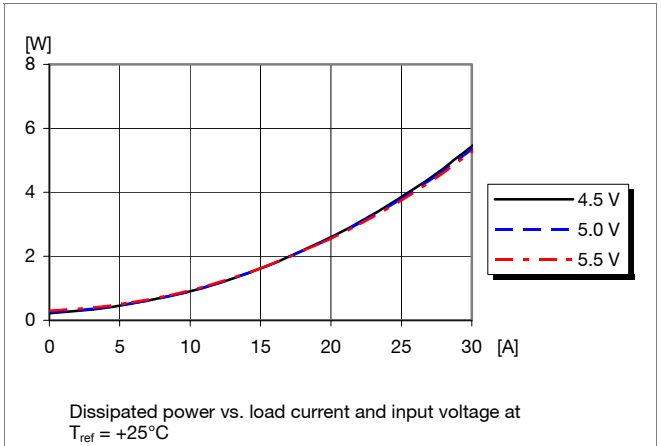

**Output Current Derating**

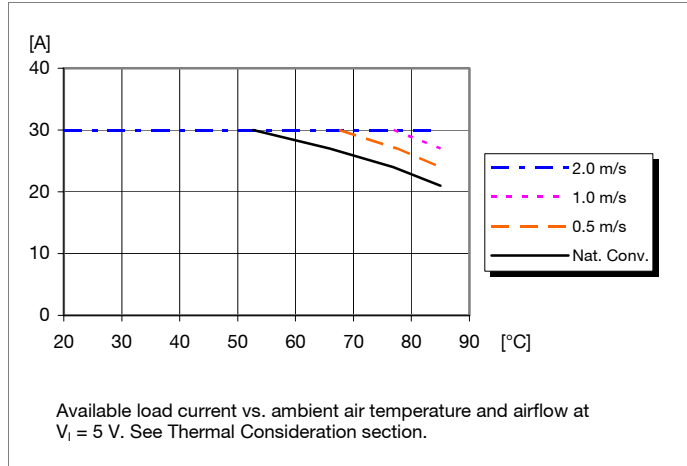

**Thermal Resistance**

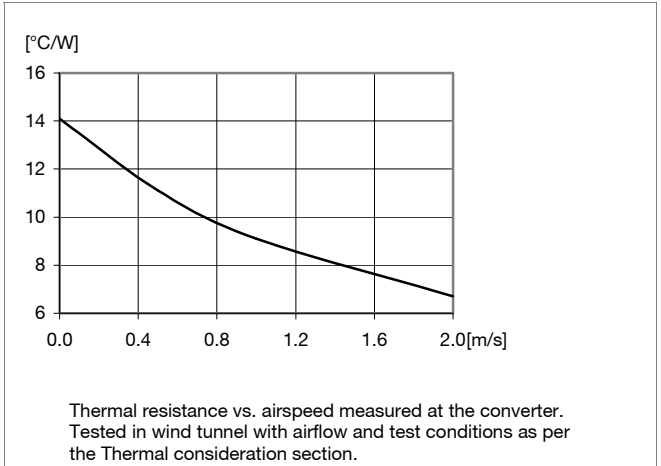

**Output Characteristics**

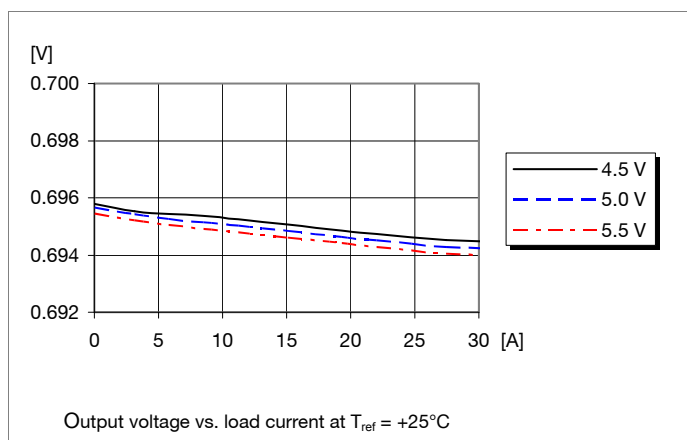

**Current Limit Characteristics**

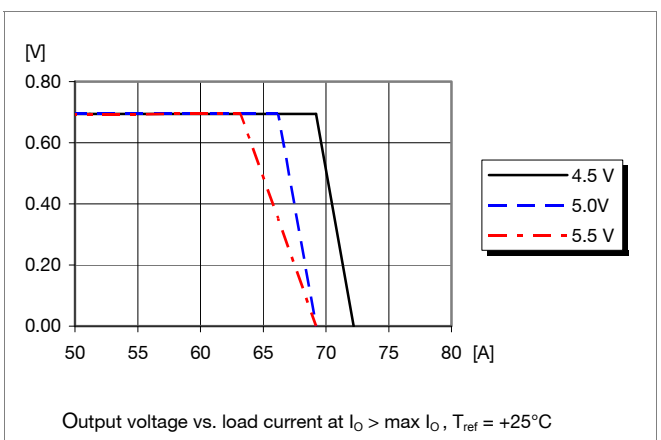

PMN 5000 series  
DC/DC regulator, Input 4.5-5.5 V, Output 30 A/108 W

EN/LZT 146 386 R1B Oct 2011

© Ericsson Power Modules AB

**0.7V, 30A / 21W Typical Characteristics**

**PMN 5118U P**

**Start-up**

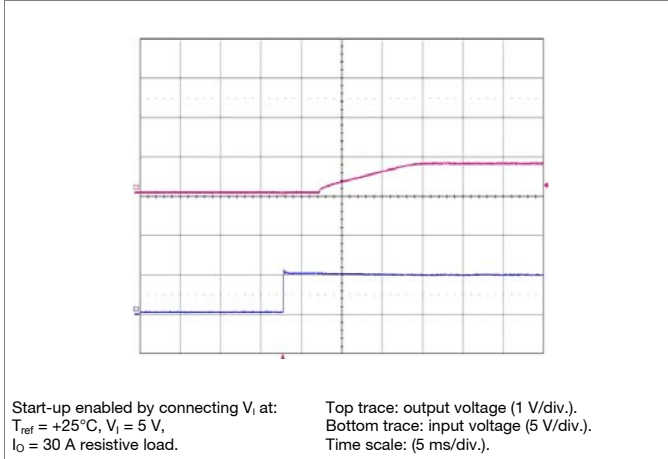

**Shut-down**

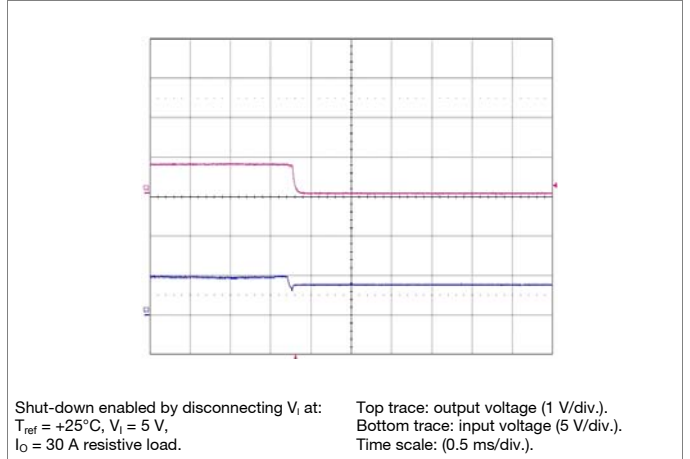

**Output Ripple & Noise**

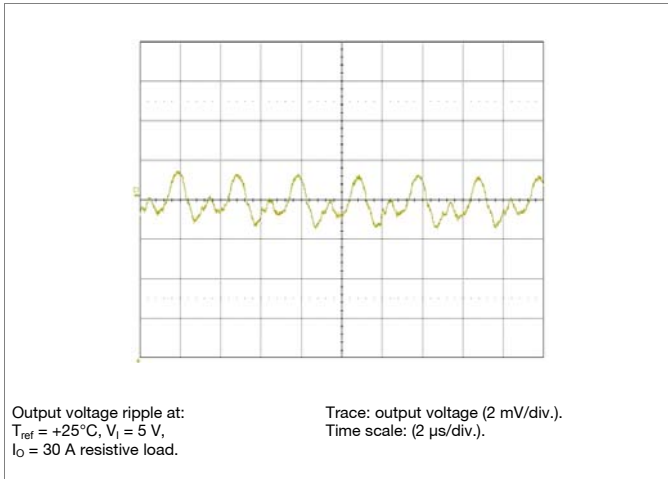

**Output Load Transient Response**

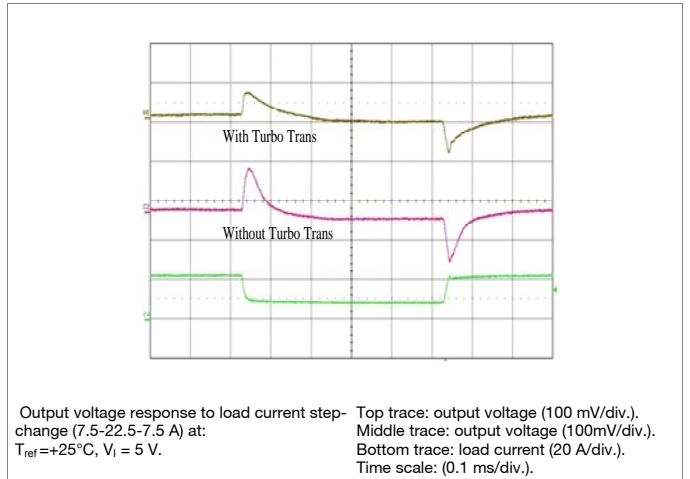

**Output Voltage Adjust (see operating information)**

**Passive adjust**

The resistor value for an adjusted output voltage is calculated by using the equations in the operating information.

$$R_{SET} = 30.1\text{ k}\Omega \times \frac{0.7}{V_o - 0.7} - 6.49\text{ k}\Omega$$

PMN 5000 series  
 DC/DC regulator, Input 4.5-5.5 V, Output 30 A/108 W

EN/LZT 146 386 R1B Oct 2011

© Ericsson Power Modules AB

**1.0V, 30A / 30W Electrical Specification**
**PMN 5118U P**
 $T_{ref} = -40$  to  $+85^{\circ}\text{C}$ ,  $V_I = 4.5$  to  $5.5$  V,  $R_{adj} = 63.4$  k $\Omega$ , unless otherwise specified under Conditions.

 Typical values given at:  $T_{ref} = +25^{\circ}\text{C}$ ,  $V_I = 5$  V, max  $I_O$ , unless otherwise specified under Conditions.

 Additional  $C_{in} = 1000$   $\mu\text{F}$  and  $C_{out} = 470$   $\mu\text{F}$ . See Operating Information section for selection of capacitor types.

Connect the sense pin, where available, to the output pin.

Characteristics		Conditions	min	typ	max	Unit
$V_I$	Input voltage range		4.5	5.0	5.5	V
$V_{loff}$	Turn-off input voltage	Decreasing input voltage	3.9	4.1		V
$V_{lon}$	Turn-on input voltage	Increasing input voltage		4.3	4.4	V
$C_I$	Internal input capacitance			94		$\mu\text{F}$
$P_O$	Output power		0		30	W
$\eta$	Efficiency	50 % of max $I_O$		89.8		%
		max $I_O$		84.6		
$P_d$	Power Dissipation	max $I_O$		5.5	6.0	W
$P_{li}$	Input idling power	$I_O = 0$ A, $V_I = 5$ V		0.33		W
$P_{RC}$	Input standby power	$V_I = 5$ V (turned off with RC)		14.1		mW
$I_s$	Static Input current	$V_I = 5$ V, max $I_O$		7.1		A
$f_s$	Switching frequency	0-100 % of max $I_O$	600	640	680	kHz

$V_{Oi}$	Output voltage initial setting and accuracy	$T_{ref} = +25^{\circ}\text{C}$ , $V_I = 5$ V, max $I_O$	0.980	1.000	1.020	V
$V_O$	Output voltage tolerance band	10-100 % of max $I_O$	0.970		1.030	V
	Idling voltage	$I_O = 0$ A		1.006		V
	Line regulation	max $I_O$		$\pm 4$		mV
	Load regulation	$V_I = 5$ V, 0-100 % of max $I_O$		$\pm 7$		mV
$V_{tr}$	Load transient voltage deviation	$V_I = 5$ V, Load step 25-75-25 % of max $I_O$ , $di/dt = 2.5$ A/ $\mu\text{s}$		$\pm 130$		mV
$t_{tr}$	Load transient recovery time	Without Turbo Trans $C_O = 820$ $\mu\text{F}$ Type C		50		$\mu\text{s}$
$V_{tr}$	Load transient voltage deviation	$V_I = 5$ V, Load step 25-75-25 % of max $I_O$ , $di/dt = 2.5$ A/ $\mu\text{s}$		$\pm 90$		mV
$t_{tr}$	Load transient recovery time	With Turbo Trans $C_O = 820$ $\mu\text{F}$ Type C; $R_{TT} = 24$ k $\Omega$		45		$\mu\text{s}$
$t_r$	Ramp-up time (from 10-90 % of $V_{Oi}$ )	100 % of max $I_O$		8.5		ms
$t_s$	Start-up time (from $V_I$ connection to 90 % of $V_{Oi}$ )			13.8		ms
$t_f$	$V_I$ shut-down fall time. (From $V_I$ off to 10 % of $V_O$ )	Max $I_O$		1.8		ms
		$I_O = 0.1$ A		8.3		ms
$t_{RC}$ $t_{inh}$	RC start-up time	Max $I_O$		16.5		ms
	RC shut-down fall time (From RC off to 10 % of $V_O$ )	Max $I_O$		0.3		ms
		$I_O = 0.1$ A		0.4		ms
$I_O$	Output current		0		30	A
$I_{lim}$	Current limit threshold	$T_{ref} < \max T_{ref}$		68		A
$I_{sc}$	Short circuit current	$T_{ref} = 25^{\circ}\text{C}$		68		A
$V_{Oac}$	Output ripple & noise	See ripple & noise section, max $I_O$		3.3		mVp-p



PMN 5000 series  
DC/DC regulator, Input 4.5-5.5 V, Output 30 A/108 W

EN/LZT 146 386 R1B Oct 2011

© Ericsson Power Modules AB

**1.0V, 30A / 30W Typical Characteristics**

**PMN 5118U P**

**Efficiency**

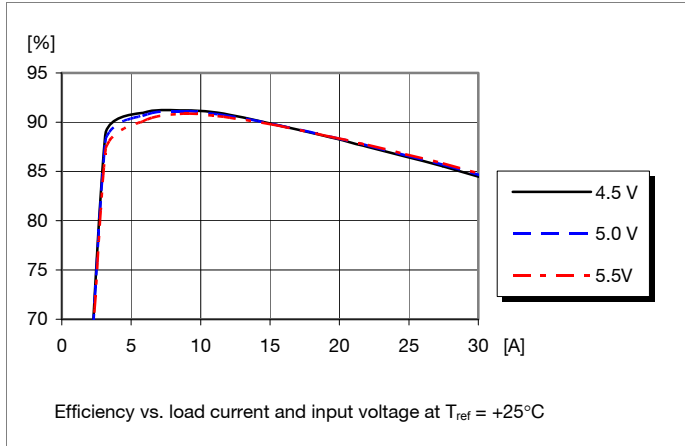

**Power Dissipation**

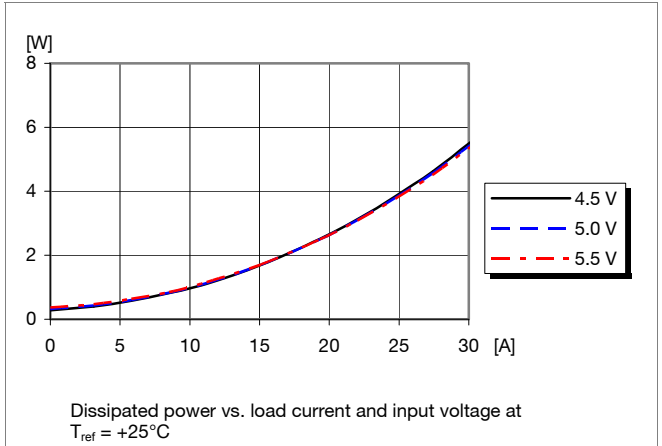

**Output Current Derating**

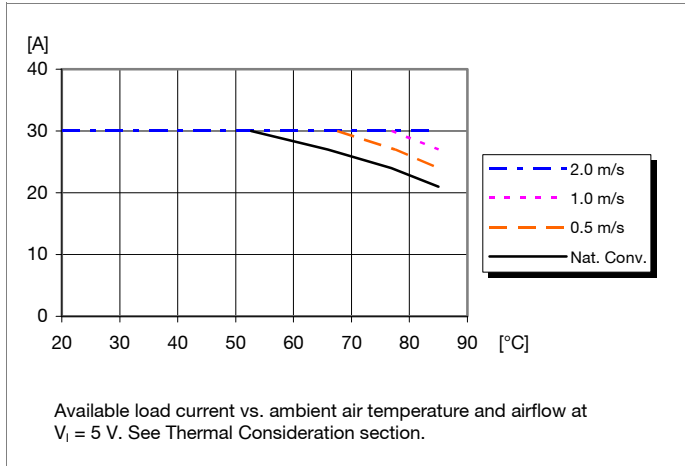

**Thermal Resistance**

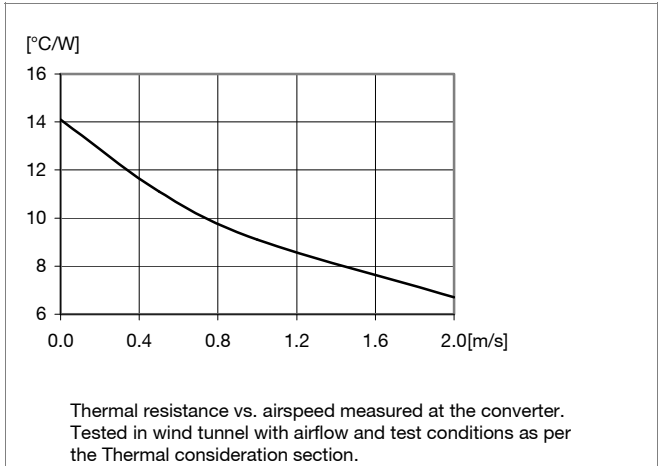

**Output Characteristics**

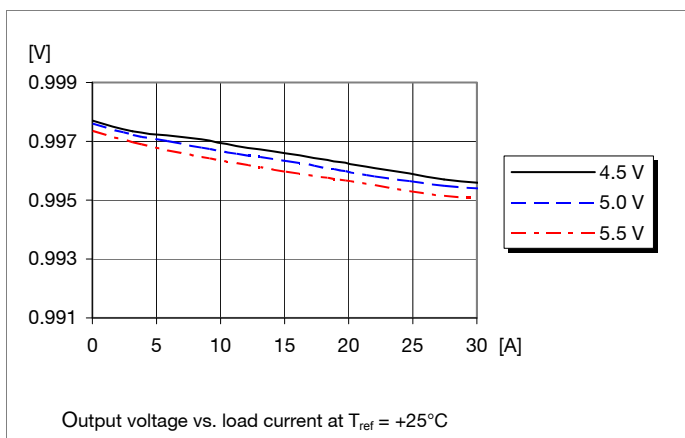

**Current Limit Characteristics**

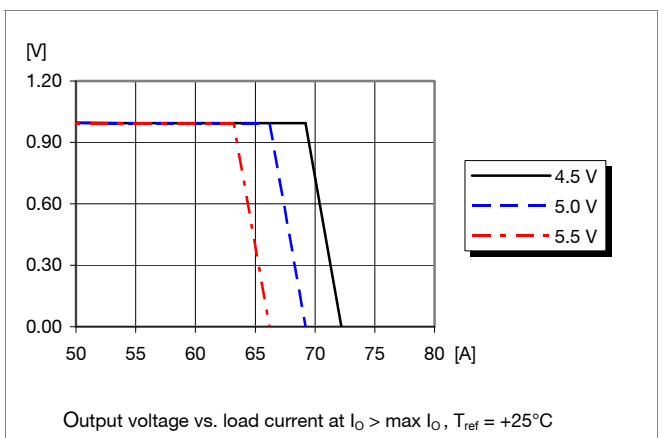

PMN 5000 series  
DC/DC regulator, Input 4.5-5.5 V, Output 30 A/108 W

EN/LZT 146 386 R1B Oct 2011

© Ericsson Power Modules AB

**1.0V, 30A / 30W Typical Characteristics**

**PMN 5118U P**

**Start-up**

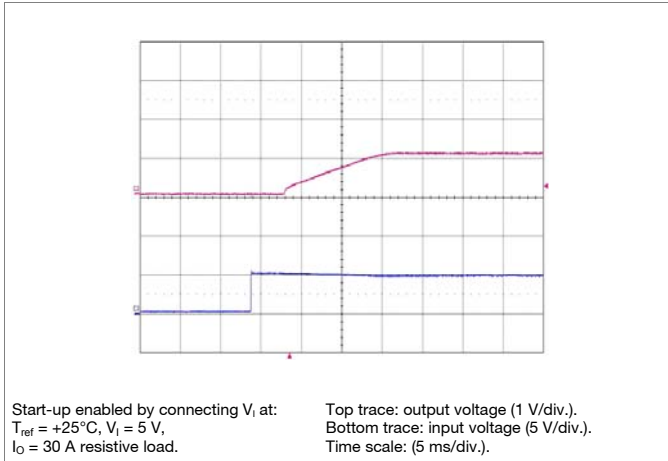

**Shut-down**

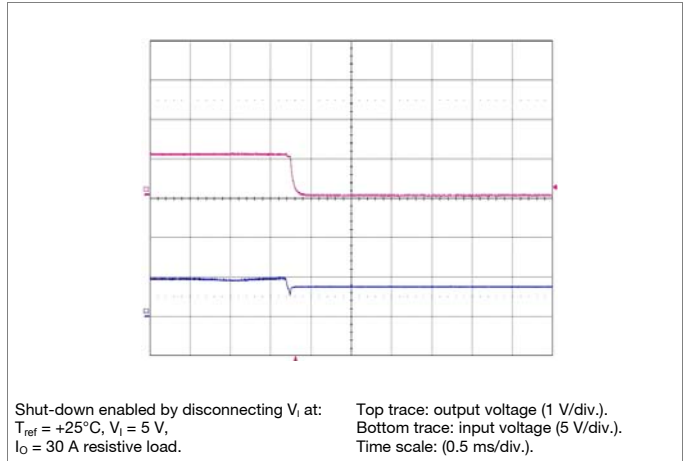

**Output Ripple & Noise**

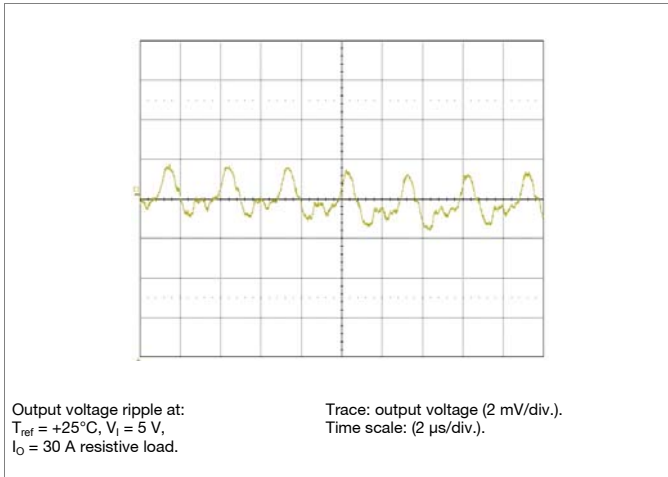

**Output Load Transient Response**

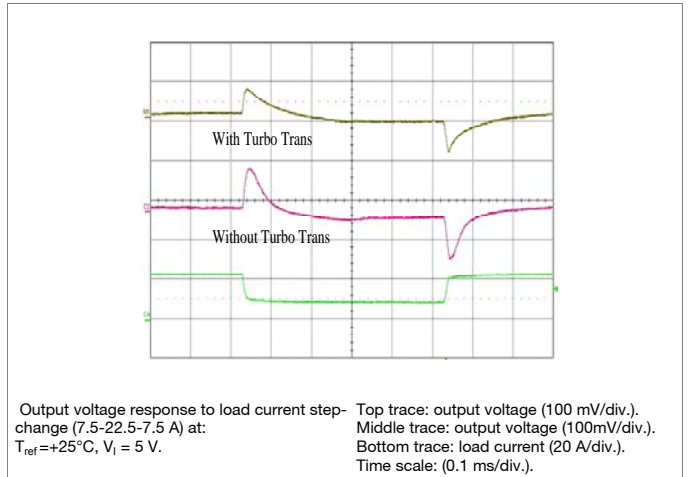

**Output Voltage Adjust (see operating information)**

**Passive adjust**

The resistor value for an adjusted output voltage is calculated by using the equations in the operating information.

$$R_{SET} = 30.1\text{ k}\Omega \times \frac{0.7}{V_o - 0.7} - 6.49\text{ k}\Omega$$

PMN 5000 series  
 DC/DC regulator, Input 4.5-5.5 V, Output 30 A/108 W

EN/LZT 146 386 R1B Oct 2011

© Ericsson Power Modules AB

**1.2V, 30A / 36W Electrical Specification**
**PMN 5118U P**
 $T_{ref} = -40$  to  $+85^{\circ}\text{C}$ ,  $V_I = 4.5$  to  $5.5$  V,  $R_{adj} = 35.7$  k $\Omega$ , unless otherwise specified under Conditions.

 Typical values given at:  $T_{ref} = +25^{\circ}\text{C}$ ,  $V_I = 5$  V, max  $I_O$ , unless otherwise specified under Conditions.

 Additional  $C_{in} = 1000$   $\mu\text{F}$  and  $C_{out} = 470$   $\mu\text{F}$ . See Operating Information section for selection of capacitor types.

Connect the sense pin, where available, to the output pin.

Characteristics		Conditions	min	typ	max	Unit
$V_I$	Input voltage range		4.5	5.0	5.5	V
$V_{loff}$	Turn-off input voltage	Decreasing input voltage	3.9	4.1		V
$V_{lon}$	Turn-on input voltage	Increasing input voltage		4.3	4.4	V
$C_I$	Internal input capacitance			94		$\mu\text{F}$
$P_O$	Output power		0		36	W
$\eta$	Efficiency	50 % of max $I_O$		91.2		%
		max $I_O$		86.7		
$P_d$	Power Dissipation	max $I_O$		5.5	6.0	W
$P_{li}$	Input idling power	$I_O = 0$ A, $V_I = 5$ V		0.37		W
$P_{RC}$	Input standby power	$V_I = 5$ V (turned off with RC)		14.1		mW
$I_s$	Static Input current	$V_I = 5$ V, max $I_O$		8.3		A
$f_s$	Switching frequency	0-100 % of max $I_O$	600	640	680	kHz

$V_{Oi}$	Output voltage initial setting and accuracy	$T_{ref} = +25^{\circ}\text{C}$ , $V_I = 5$ V, max $I_O$	1.176	1.200	1.224	V
$V_O$	Output voltage tolerance band	10-100 % of max $I_O$	1.164		1.236	V
	Idling voltage	$I_O = 0$ A		1.206		V
	Line regulation	max $I_O$		$\pm 4$		mV
	Load regulation	$V_I = 5$ V, 0-100 % of max $I_O$		$\pm 7$		mV
$V_{tr}$	Load transient voltage deviation	$V_I = 5$ V, Load step 25-75-25 % of max $I_O$ , $di/dt = 2.5$ A/ $\mu\text{s}$		$\pm 130$		mV
$t_{tr}$	Load transient recovery time	Without Turbo Trans $C_O = 820$ $\mu\text{F}$ Type C		50		$\mu\text{s}$
$V_{tr}$	Load transient voltage deviation	$V_I = 5$ V, Load step 25-75-25 % of max $I_O$ , $di/dt = 2.5$ A/ $\mu\text{s}$		$\pm 90$		mV
$t_{tr}$	Load transient recovery time	With Turbo Trans $C_O = 820$ $\mu\text{F}$ Type C; $R_{TT} = 24$ k $\Omega$		45		$\mu\text{s}$
$t_r$	Ramp-up time (from 10-90 % of $V_{Oi}$ )	100 % of max $I_O$		8.6		ms
$t_s$	Start-up time (from $V_I$ connection to 90 % of $V_{Oi}$ )			14.8		ms
$t_f$	$V_I$ shut-down fall time. (From $V_I$ off to 10 % of $V_O$ )	Max $I_O$		1.8		ms
		$I_O = 0.1$ A		10.0		ms
$t_{RC}$ $t_{inh}$	RC start-up time	Max $I_O$		16.6		ms
	RC shut-down fall time (From RC off to 10 % of $V_O$ )	Max $I_O$		0.3		ms
		$I_O = 0.1$ A		0.4		ms
$I_O$	Output current		0		30	A
$I_{lim}$	Current limit threshold	$T_{ref} < \max T_{ref}$		68		A
$I_{sc}$	Short circuit current	$T_{ref} = 25^{\circ}\text{C}$		68		A
$V_{Oac}$	Output ripple & noise	See ripple & noise section, max $I_O$		3.0		mVp-p

PMN 5000 series  
DC/DC regulator, Input 4.5-5.5 V, Output 30 A/108 W

EN/LZT 146 386 R1B Oct 2011

© Ericsson Power Modules AB

**1.2V, 30A / 36W Typical Characteristics**

**PMN 5118U P**

**Efficiency**

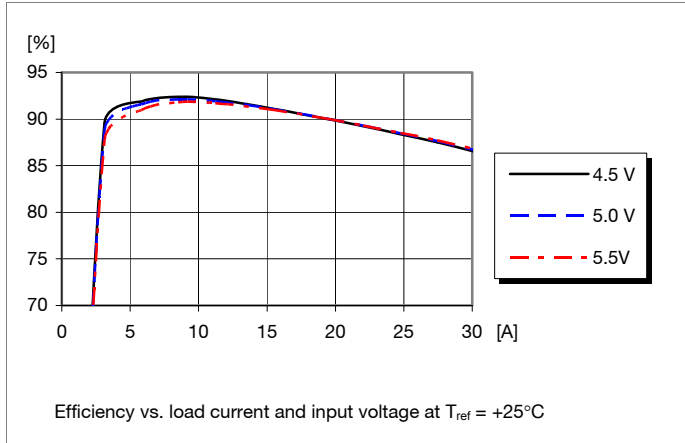

**Power Dissipation**

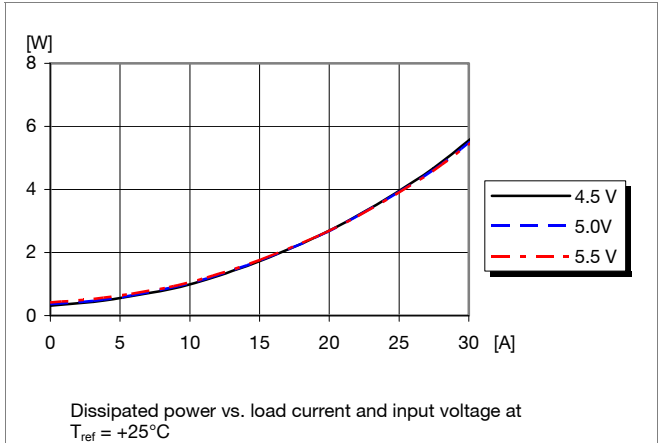

**Output Current Derating**

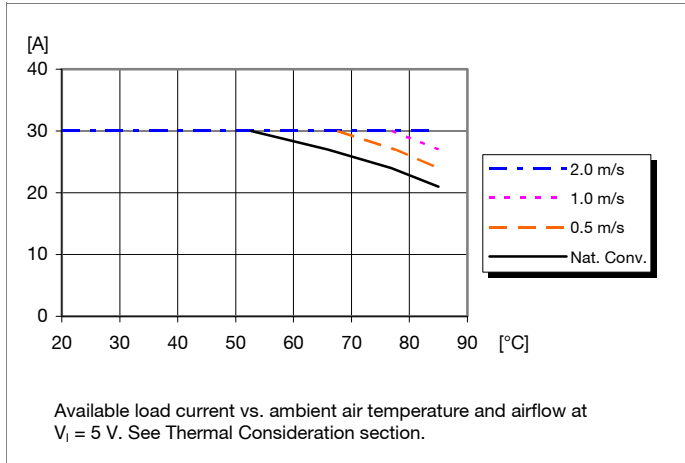

**Thermal Resistance**

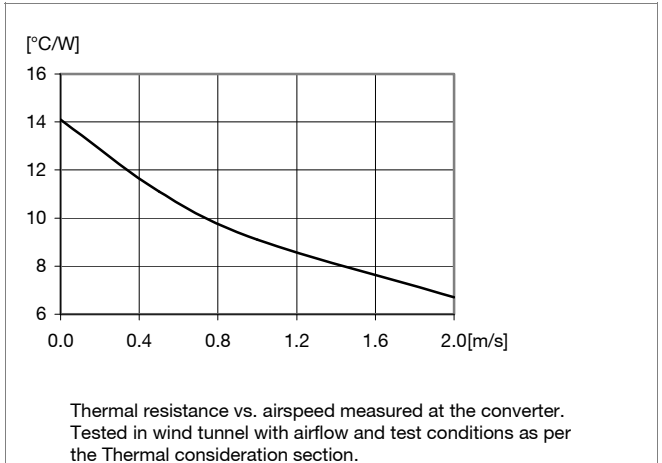

**Output Characteristics**

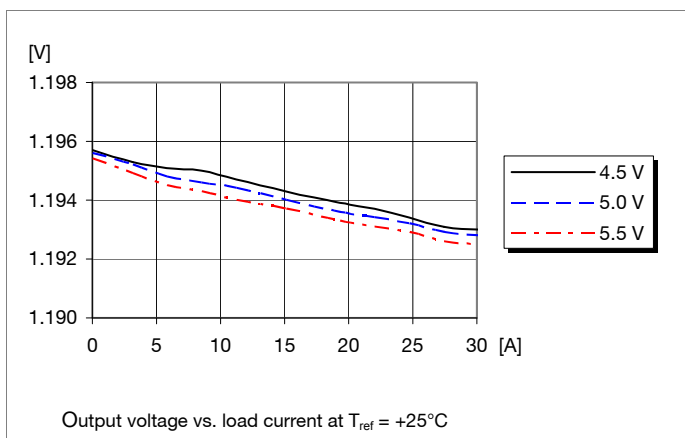

**Current Limit Characteristics**

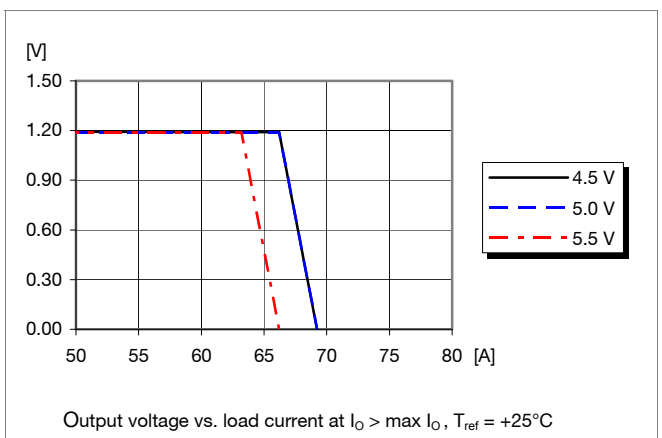

PMN 5000 series  
DC/DC regulator, Input 4.5-5.5 V, Output 30 A/108 W

EN/LZT 146 386 R1B Oct 2011

© Ericsson Power Modules AB

**1.2V, 30A / 36W Typical Characteristics**

**PMN 5118U P**

**Start-up**

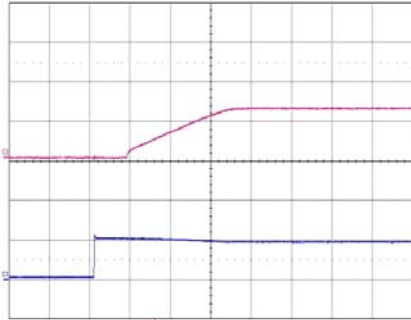

Start-up enabled by connecting  $V_i$  at:  
 $T_{ref} = +25^\circ\text{C}$ ,  $V_i = 5\text{ V}$ ,  
 $I_o = 30\text{ A}$  resistive load.  
Top trace: output voltage (1 V/div.).  
Bottom trace: input voltage (5 V/div.).  
Time scale: (5 ms/div.).

**Shut-down**

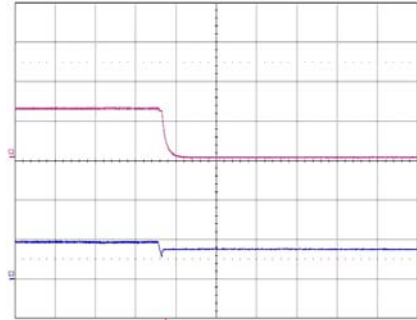

Shut-down enabled by disconnecting  $V_i$  at:  
 $T_{ref} = +25^\circ\text{C}$ ,  $V_i = 5\text{ V}$ ,  
 $I_o = 30\text{ A}$  resistive load.  
Top trace: output voltage (1 V/div.).  
Bottom trace: input voltage (5 V/div.).  
Time scale: (0.5 ms/div.).

**Output Ripple & Noise**

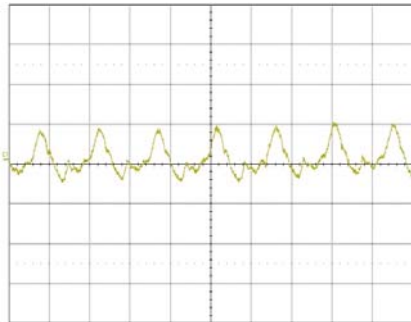

Output voltage ripple at:  
 $T_{ref} = +25^\circ\text{C}$ ,  $V_i = 5\text{ V}$ ,  
 $I_o = 30\text{ A}$  resistive load.  
Trace: output voltage (2 mV/div.).  
Time scale: (2  $\mu\text{s}$ /div.).

**Output Load Transient Response**

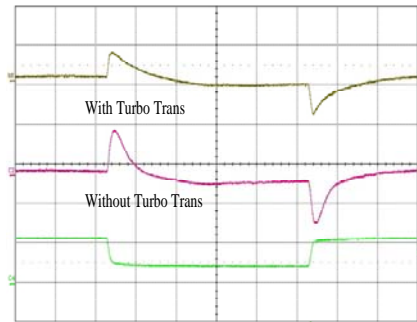

Output voltage response to load current step-change (7.5-22.5-7.5 A) at:  
 $T_{ref} = +25^\circ\text{C}$ ,  $V_i = 5\text{ V}$ .  
Top trace: output voltage (100 mV/div.).  
Middle trace: output voltage (100mV/div.).  
Bottom trace: load current (20 A/div.).  
Time scale: (0.1 ms/div.).

**Output Voltage Adjust (see operating information)**

**Passive adjust**

The resistor value for an adjusted output voltage is calculated by using the equations in the operating information.

$$R_{SET} = 30.1\text{ k}\Omega \times \frac{0.7}{V_o - 0.7} - 6.49\text{ k}\Omega$$

PMN 5000 series DC/DC regulator, Input 4.5-5.5 V, Output 30 A/108 W	EN/LZT 146 386 R1B Oct 2011
	© Ericsson Power Modules AB

**1.5V, 30A / 45W Electrical Specification**
**PMN 5118U P**
 $T_{ref} = -40$  to  $+85^{\circ}\text{C}$ ,  $V_I = 4.5$  to  $5.5$  V,  $R_{adj} = 19.6$  k $\Omega$ , unless otherwise specified under Conditions.

 Typical values given at:  $T_{ref} = +25^{\circ}\text{C}$ ,  $V_I = 5$  V, max  $I_O$ , unless otherwise specified under Conditions.

 Additional  $C_{in} = 1000$   $\mu\text{F}$  and  $C_{out} = 470$   $\mu\text{F}$ . See Operating Information section for selection of capacitor types.

Connect the sense pin, where available, to the output pin.

Characteristics		Conditions	min	typ	max	Unit
$V_I$	Input voltage range		4.5	5.0	5.5	V
$V_{loff}$	Turn-off input voltage	Decreasing input voltage	3.9	4.1		V
$V_{lon}$	Turn-on input voltage	Increasing input voltage		4.3	4.4	V
$C_I$	Internal input capacitance			94		$\mu\text{F}$
$P_O$	Output power		0		45	W
$\eta$	Efficiency	50 % of max $I_O$		92.6		%
		max $I_O$		89.0		
$P_d$	Power Dissipation	max $I_O$		5.5	6.0	W
$P_{li}$	Input idling power	$I_O = 0$ A, $V_I = 5$ V		0.44		W
$P_{RC}$	Input standby power	$V_I = 5$ V (turned off with RC)		11.0		mW
$I_s$	Static Input current	$V_I = 5$ V, max $I_O$		10.2		A
$f_s$	Switching frequency	0-100 % of max $I_O$	600	640	680	kHz

$V_{Oi}$	Output voltage initial setting and accuracy	$T_{ref} = +25^{\circ}\text{C}$ , $V_I = 5$ V, max $I_O$	1.470	1.500	1.530	V
$V_O$	Output voltage tolerance band	10-100 % of max $I_O$	1.455		1.545	V
	Idling voltage	$I_O = 0$ A		1.504		V
	Line regulation	max $I_O$		$\pm 4$		mV
	Load regulation	$V_I = 5$ V, 0-100 % of max $I_O$		$\pm 7$		mV
$V_{tr}$	Load transient voltage deviation	$V_I = 5$ V, Load step 25-75-25 % of max $I_O$ , $di/dt = 2.5$ A/ $\mu\text{s}$		$\pm 130$		mV
$t_{tr}$	Load transient recovery time	Without Turbo Trans $C_O = 820$ $\mu\text{F}$ Type C		50		$\mu\text{s}$
$V_{tr}$	Load transient voltage deviation	$V_I = 5$ V, Load step 25-75-25 % of max $I_O$ , $di/dt = 2.5$ A/ $\mu\text{s}$		$\pm 95$		mV
$t_{tr}$	Load transient recovery time	With Turbo Trans $C_O = 820$ $\mu\text{F}$ Type C; $R_{TT} = 24$ k $\Omega$		50		$\mu\text{s}$
$t_r$	Ramp-up time (from 10-90 % of $V_{Oi}$ )	100 % of max $I_O$		9.3		ms
$t_s$	Start-up time (from $V_I$ connection to 90 % of $V_{Oi}$ )			14.5		ms
$t_f$	$V_I$ shut-down fall time. (From $V_I$ off to 10 % of $V_O$ )	Max $I_O$		1.8		ms
		$I_O = 0.1$ A		13.1		ms
$t_{RC}$ $t_{inh}$	RC start-up time	Max $I_O$		16.4		ms
	RC shut-down fall time (From RC off to 10 % of $V_O$ )	Max $I_O$		0.3		ms
		$I_O = 0.1$ A		0.4		ms
$I_O$	Output current		0		30	A
$I_{lim}$	Current limit threshold	$T_{ref} < \max T_{ref}$		68		A
$I_{sc}$	Short circuit current	$T_{ref} = 25^{\circ}\text{C}$		68		A
$V_{Oac}$	Output ripple & noise	See ripple & noise section, max $I_O$		3.5		mVp-p

PMN 5000 series  
DC/DC regulator, Input 4.5-5.5 V, Output 30 A/108 W

EN/LZT 146 386 R1B Oct 2011

© Ericsson Power Modules AB

**1.5V, 30A / 45W Typical Characteristics**

**PMN 5118U P**

**Efficiency**

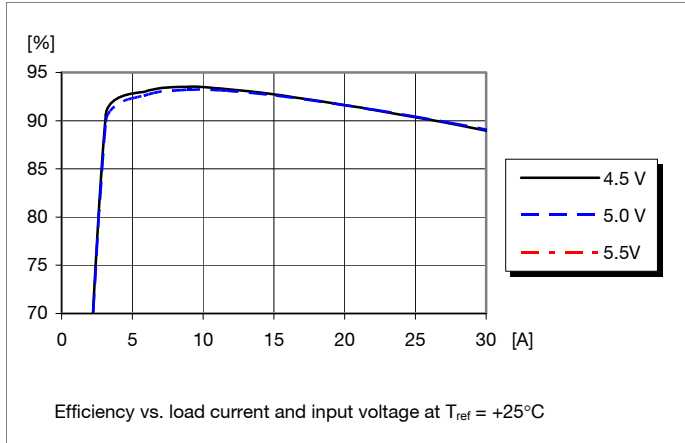

**Power Dissipation**

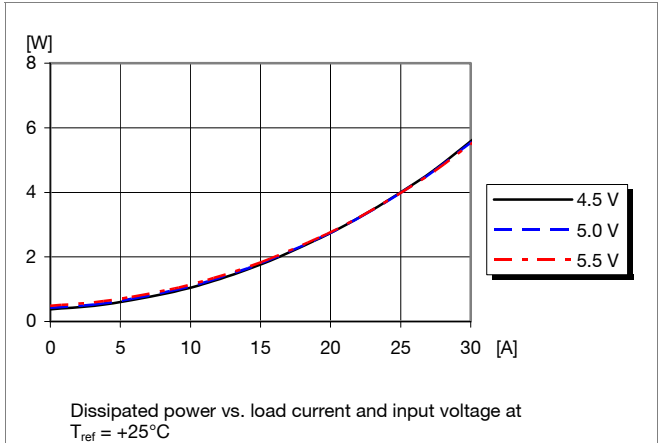

**Output Current Derating**

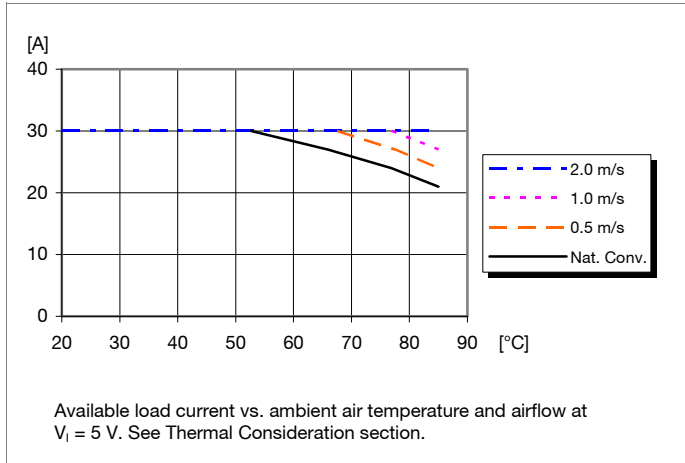

**Thermal Resistance**

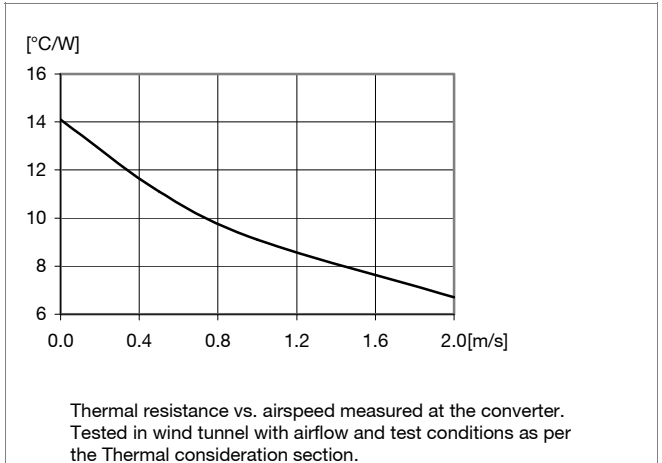

**Output Characteristics**

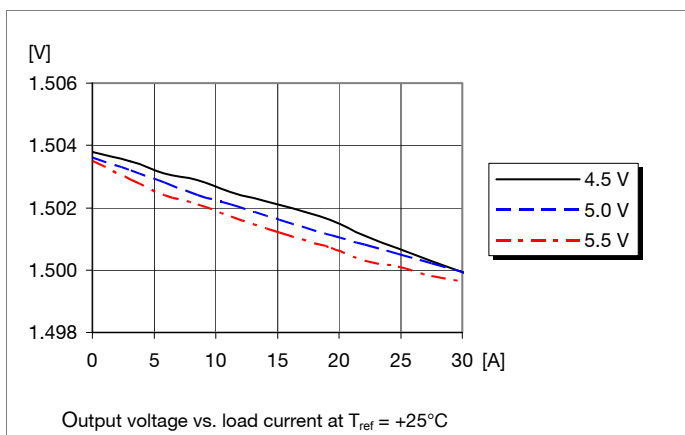

**Current Limit Characteristics**

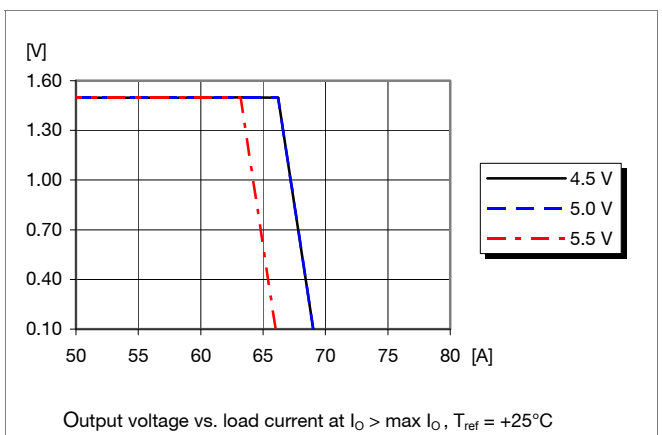

PMN 5000 series  
DC/DC regulator, Input 4.5-5.5 V, Output 30 A/108 W

EN/LZT 146 386 R1B Oct 2011

© Ericsson Power Modules AB

**1.5V, 30A / 45W Typical Characteristics**

**PMN 5118U P**

**Start-up**

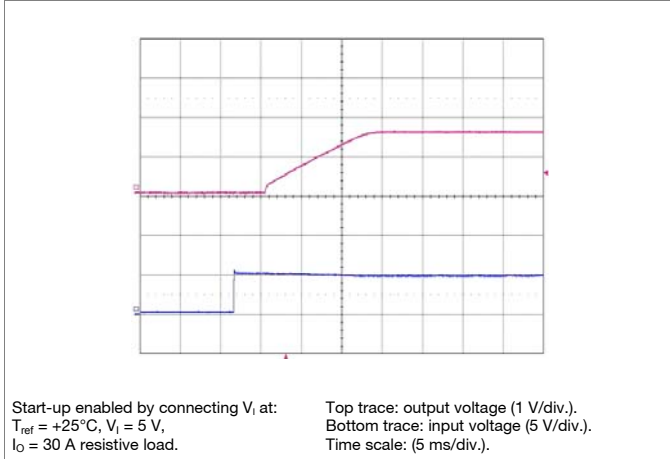

**Shut-down**

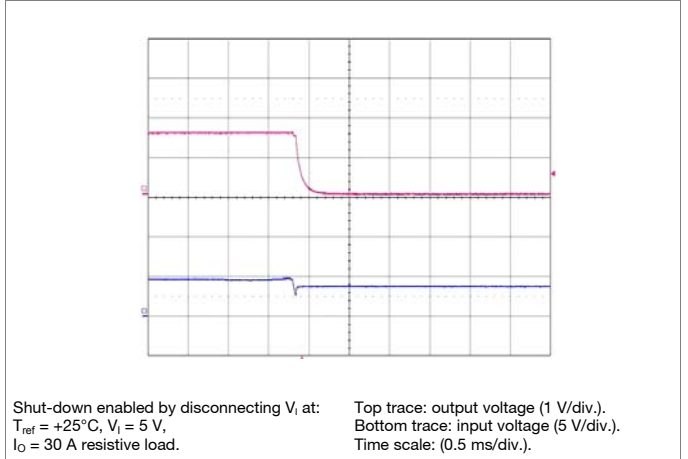

**Output Ripple & Noise**

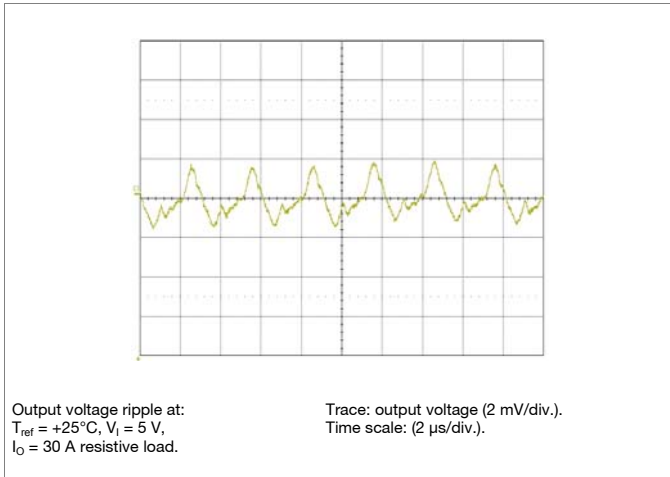

**Output Load Transient Response**

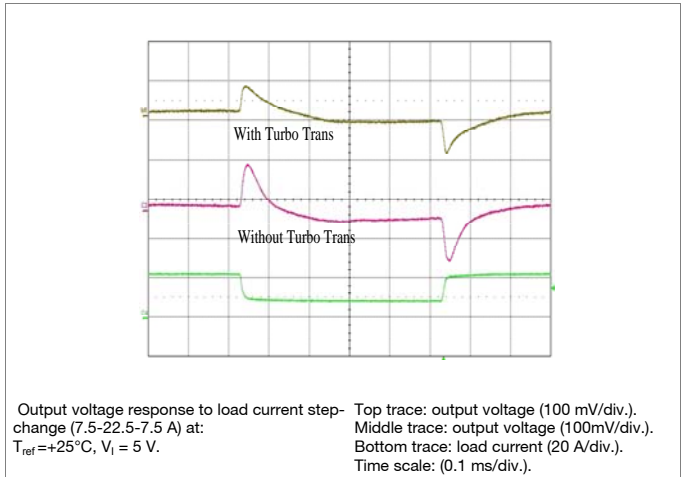

**Output Voltage Adjust (see operating information)**

**Passive adjust**

The resistor value for an adjusted output voltage is calculated by using the equations in the operating information.

$$R_{SET} = 30.1\text{ k}\Omega \times \frac{0.7}{V_o - 0.7} - 6.49\text{ k}\Omega$$



PMN 5000 series  
 DC/DC regulator, Input 4.5-5.5 V, Output 30 A/108 W

EN/LZT 146 386 R1B Oct 2011

© Ericsson Power Modules AB

**1.8V, 30A / 54W Electrical Specification**
**PMN 5118U P**
 $T_{ref} = -40$  to  $+85^{\circ}\text{C}$ ,  $V_I = 4.5$  to  $5.5$  V,  $R_{adj} = 5.7$  k $\Omega$ , unless otherwise specified under Conditions.

 Typical values given at:  $T_{ref} = +25^{\circ}\text{C}$ ,  $V_I = 5$  V, max  $I_O$ , unless otherwise specified under Conditions.

 Additional  $C_{in} = 1000$   $\mu\text{F}$  and  $C_{out} = 470$   $\mu\text{F}$ . See Operating Information section for selection of capacitor types.

Connect the sense pin, where available, to the output pin.

Characteristics		Conditions	min	typ	max	Unit
$V_I$	Input voltage range		4.5	5	5.5	V
$V_{loff}$	Turn-off input voltage	Decreasing input voltage	3.9	4.1		V
$V_{lon}$	Turn-on input voltage	Increasing input voltage		4.3	4.4	V
$C_I$	Internal input capacitance			94		$\mu\text{F}$
$P_O$	Output power		0		54	W
$\eta$	Efficiency	50 % of max $I_O$		93.5		%
		max $I_O$		90.6		
$P_d$	Power Dissipation	max $I_O$		5.6	6.1	W
$P_{li}$	Input idling power	$I_O = 0$ A, $V_I = 5$ V		0.49		W
$P_{RC}$	Input standby power	$V_I = 5$ V (turned off with RC)		11.0		mW
$I_s$	Static Input current	$V_I = 5$ V, max $I_O$		11.9		A
$f_s$	Switching frequency	0-100 % of max $I_O$	600	640	680	kHz

$V_{Oi}$	Output voltage initial setting and accuracy	$T_{ref} = +25^{\circ}\text{C}$ , $V_I = 5$ V, max $I_O$	1.764	1.800	1.836	V
$V_O$	Output voltage tolerance band	10-100 % of max $I_O$	1.746		1.854	V
	Idling voltage	$I_O = 0$ A		1.794		V
	Line regulation	max $I_O$		$\pm 4$		mV
	Load regulation	$V_I = 5$ V, 0-100 % of max $I_O$		$\pm 7$		mV
$V_{tr}$	Load transient voltage deviation	$V_I = 5$ V, Load step 25-75-25 % of max $I_O$ , $di/dt = 2.5$ A/ $\mu\text{s}$		$\pm 140$		mV
$t_{tr}$	Load transient recovery time	Without Turbo Trans $C_O = 820$ $\mu\text{F}$ Type C		60		$\mu\text{s}$
$V_{tr}$	Load transient voltage deviation	$V_I = 5$ V, Load step 25-75-25 % of max $I_O$ , $di/dt = 2.5$ A/ $\mu\text{s}$		$\pm 95$		mV
$t_{tr}$	Load transient recovery time	With Turbo Trans $C_O = 820$ $\mu\text{F}$ Type C; $R_{TT} = 24$ k $\Omega$		60		$\mu\text{s}$
$t_r$	Ramp-up time (from 10-90 % of $V_{Oi}$ )	100 % of max $I_O$		9.3		ms
$t_s$	Start-up time (from $V_I$ connection to 90 % of $V_{Oi}$ )			14.8		ms
$t_f$	$V_I$ shut-down fall time. (From $V_I$ off to 10 % of $V_O$ )	Max $I_O$		1.9		ms
		$I_O = 0.1$ A		15.9		ms
$t_{RC}$ $t_{inh}$	RC start-up time	Max $I_O$		16.6		ms
	RC shut-down fall time (From RC off to 10 % of $V_O$ )	Max $I_O$		0.3		ms
		$I_O = 0.1$ A		0.4		ms
$I_O$	Output current		0		30	A
$I_{lim}$	Current limit threshold	$T_{ref} < \max T_{ref}$		68		A
$I_{sc}$	Short circuit current	$T_{ref} = 25^{\circ}\text{C}$		68		A
$V_{Oac}$	Output ripple & noise	See ripple & noise section, max $I_O$		3.2		mVp-p

PMN 5000 series  
DC/DC regulator, Input 4.5-5.5 V, Output 30 A/108 W

EN/LZT 146 386 R1B Oct 2011

© Ericsson Power Modules AB

**1.8V, 30A / 54W Typical Characteristics**

**PMN 5118U P**

**Efficiency**

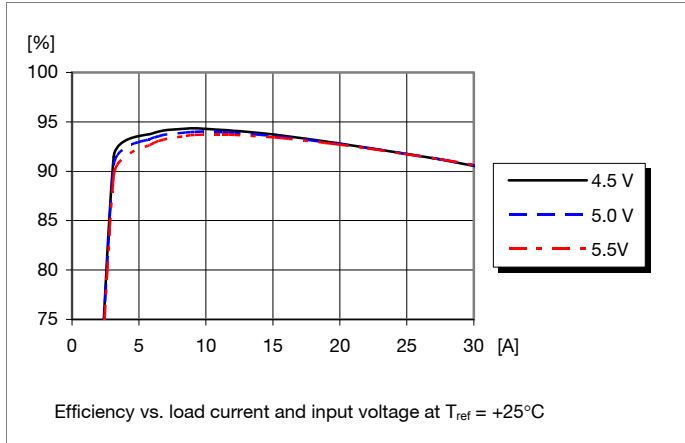

**Power Dissipation**

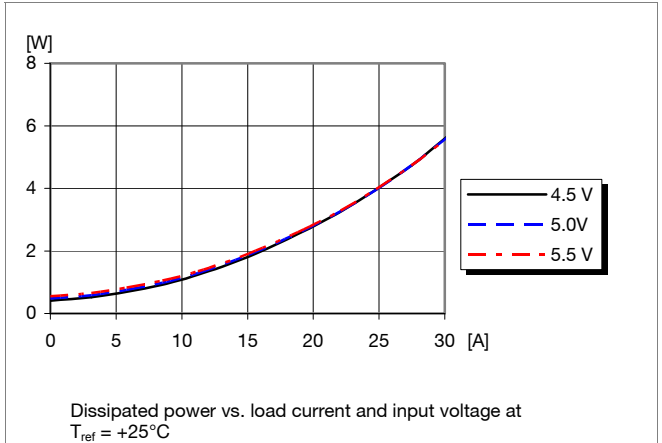

**Output Current Derating**

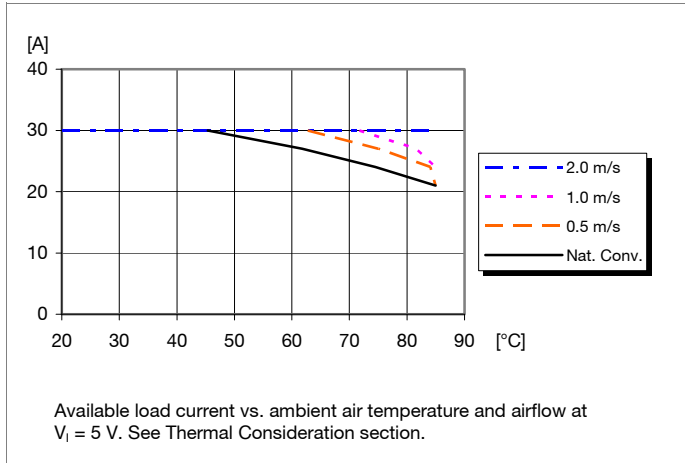

**Thermal Resistance**

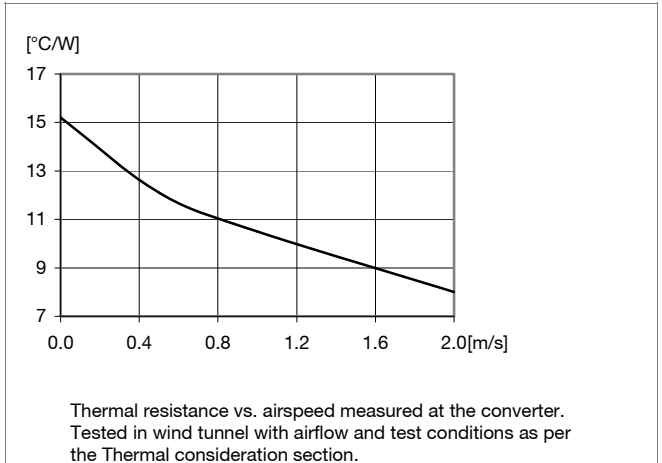

**Output Characteristics**

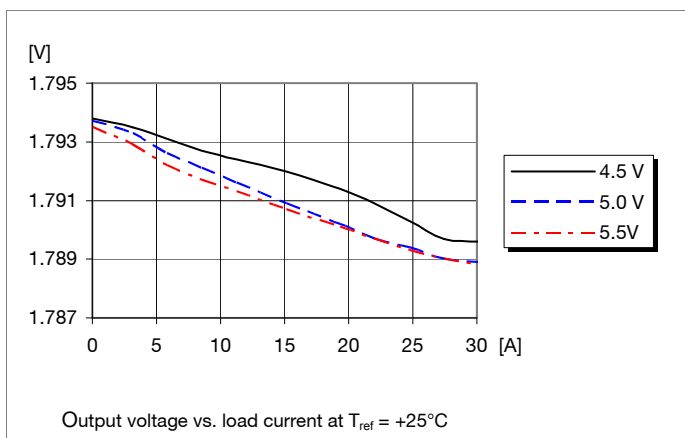

**Current Limit Characteristics**

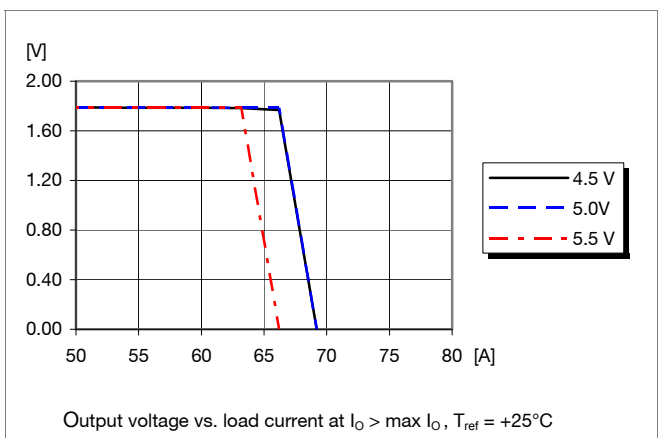

PMN 5000 series  
DC/DC regulator, Input 4.5-5.5 V, Output 30 A/108 W

EN/LZT 146 386 R1B Oct 2011

© Ericsson Power Modules AB

**1.8V, 30A / 54W Typical Characteristics**

**PMN 5118U P**

**Start-up**

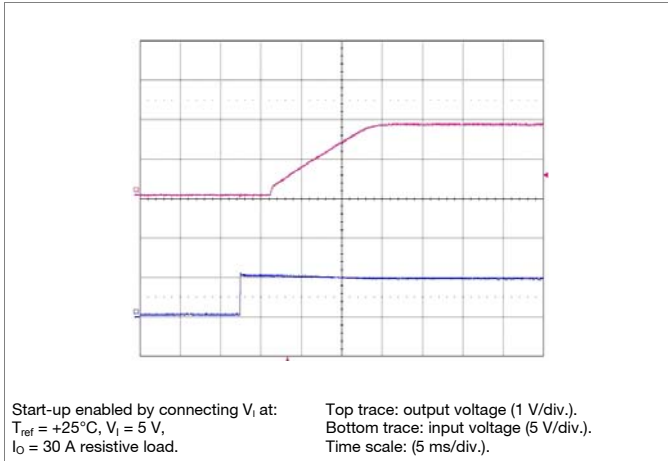

**Shut-down**

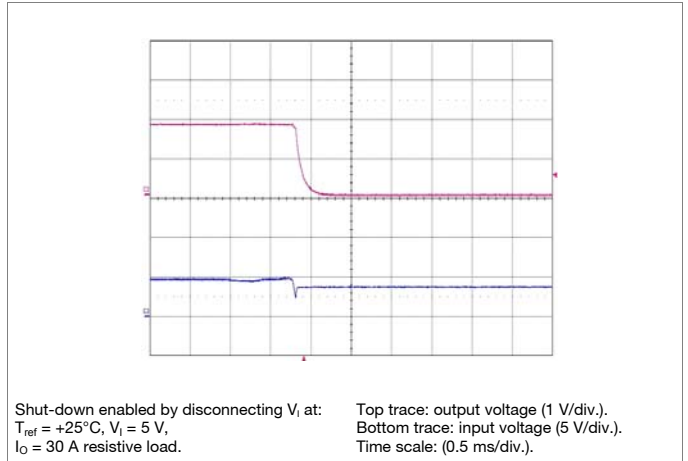

**Output Ripple & Noise**

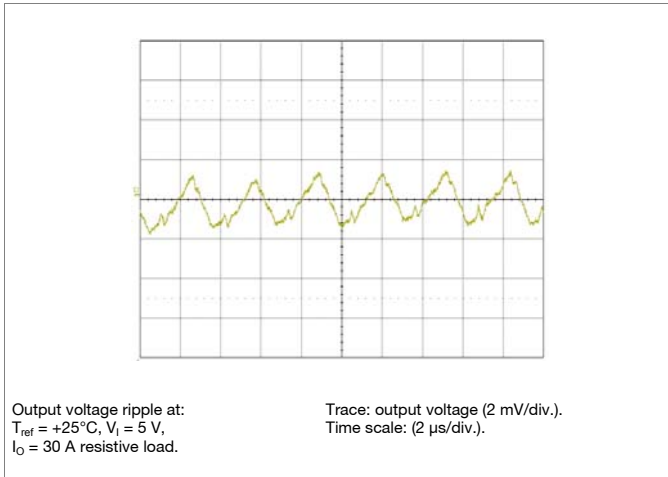

**Output Load Transient Response**

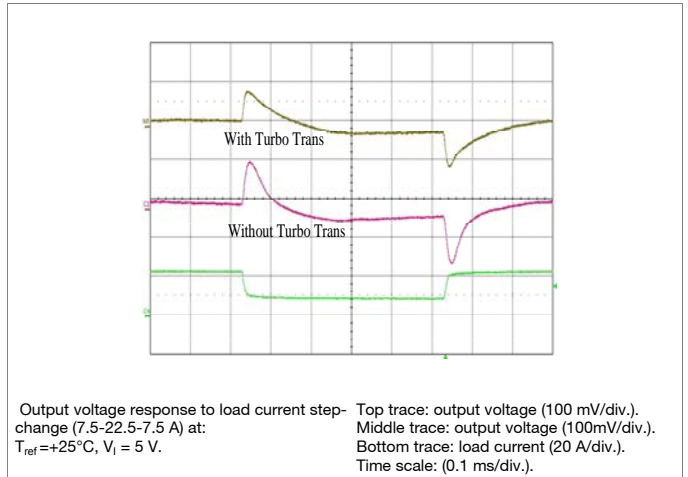

**Output Voltage Adjust (see operating information)**

**Passive adjust**

The resistor value for an adjusted output voltage is calculated by using the equations in the operating information.

$$R_{SET} = 30.1\text{ k}\Omega \times \frac{0.7}{V_o - 0.7} - 6.49\text{ k}\Omega$$

PMN 5000 series  
 DC/DC regulator, Input 4.5-5.5 V, Output 30 A/108 W

EN/LZT 146 386 R1B Oct 2011

© Ericsson Power Modules AB

**2.5V, 30A / 75W Electrical Specification**
**PMN 5118U P**
 $T_{ref} = -40$  to  $+85^{\circ}\text{C}$ ,  $V_I = 4.5$  to  $5.5$  V,  $R_{adj} = 5.23$  k $\Omega$ , unless otherwise specified under Conditions.

 Typical values given at:  $T_{ref} = +25^{\circ}\text{C}$ ,  $V_I = 5$  V, max  $I_O$ , unless otherwise specified under Conditions.

 Additional  $C_{in} = 1000$   $\mu\text{F}$  and  $C_{out} = 470$   $\mu\text{F}$ . See Operating Information section for selection of capacitor types.

Connect the sense pin, where available, to the output pin.

Characteristics		Conditions	min	typ	max	Unit
$V_I$	Input voltage range		4.5	5	5.5	V
$V_{loff}$	Turn-off input voltage	Decreasing input voltage	3.9	4.1		V
$V_{lon}$	Turn-on input voltage	Increasing input voltage		4.3	4.4	V
$C_I$	Internal input capacitance			94		$\mu\text{F}$
$P_O$	Output power		0		75	W
$\eta$	Efficiency	50 % of max $I_O$		95.1		%
		max $I_O$		93.0		
$P_d$	Power Dissipation	max $I_O$		5.7	6.2	W
$P_{li}$	Input idling power	$I_O = 0$ A, $V_I = 5$ V		0.56		W
$P_{RC}$	Input standby power	$V_I = 5$ V (turned off with RC)		11.0		mW
$I_s$	Static Input current	$V_I = 5$ V, max $I_O$		16.1		A
$f_s$	Switching frequency	0-100 % of max $I_O$	600	640	680	kHz

$V_{Oi}$	Output voltage initial setting and accuracy	$T_{ref} = +25^{\circ}\text{C}$ , $V_I = 5$ V, max $I_O$	2.450	2.500	2.550	V
$V_O$	Output voltage tolerance band	10-100 % of max $I_O$	2.425		2.575	V
	Idling voltage	$I_O = 0$ A		2.491		V
	Line regulation	max $I_O$		$\pm 4$		mV
	Load regulation	$V_I = 5$ V, 0-100 % of max $I_O$		$\pm 7$		mV
$V_{tr}$	Load transient voltage deviation	$V_I = 5$ V, Load step 25-75-25 % of max $I_O$ , $di/dt = 2.5$ A/ $\mu\text{s}$		$\pm 130$		mV
$t_{tr}$	Load transient recovery time	Without Turbo Trans $C_O = 820$ $\mu\text{F}$ Type C		60		$\mu\text{s}$
$V_{tr}$	Load transient voltage deviation	$V_I = 5$ V, Load step 25-75-25 % of max $I_O$ , $di/dt = 2.5$ A/ $\mu\text{s}$		$\pm 85$		mV
$t_{tr}$	Load transient recovery time	With Turbo Trans $C_O = 820$ $\mu\text{F}$ Type C; $R_{TT} = 24$ k $\Omega$		60		$\mu\text{s}$
$t_r$	Ramp-up time (from 10-90 % of $V_{Oi}$ )	100 % of max $I_O$		9.7		ms
$t_s$	Start-up time (from $V_I$ connection to 90 % of $V_{Oi}$ )			15.1		ms
$t_f$	$V_I$ shut-down fall time. (From $V_I$ off to 10 % of $V_O$ )	Max $I_O$		1.6		ms
		$I_O = 0.1$ A		22.5		ms
$t_{RC}$ $t_{inh}$	RC start-up time	Max $I_O$		16.0		ms
	RC shut-down fall time (From RC off to 10 % of $V_O$ )	Max $I_O$		0.3		ms
		$I_O = 0.1$ A		0.5		ms
$I_O$	Output current		0		30	A
$I_{lim}$	Current limit threshold	$T_{ref} < \max T_{ref}$		65		A
$I_{sc}$	Short circuit current	$T_{ref} = 25^{\circ}\text{C}$		65		A
$V_{Oac}$	Output ripple & noise	See ripple & noise section, max $I_O$		3.5		mVp-p

PMN 5000 series  
DC/DC regulator, Input 4.5-5.5 V, Output 30 A/108 W

EN/LZT 146 386 R1B Oct 2011

© Ericsson Power Modules AB

**2.5V, 30A / 75W Typical Characteristics**

**PMN 5118U P**

**Efficiency**

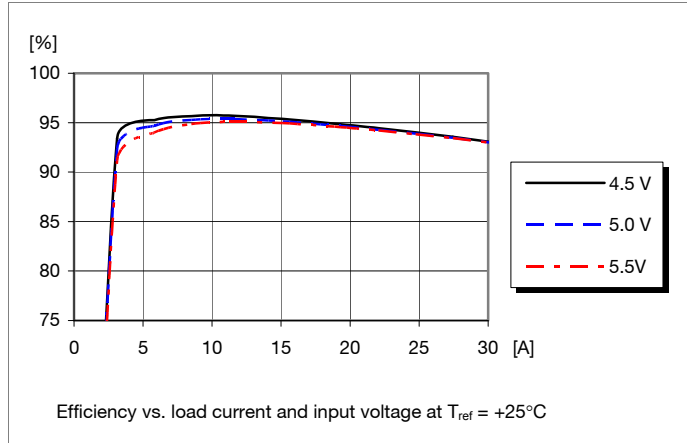

**Power Dissipation**

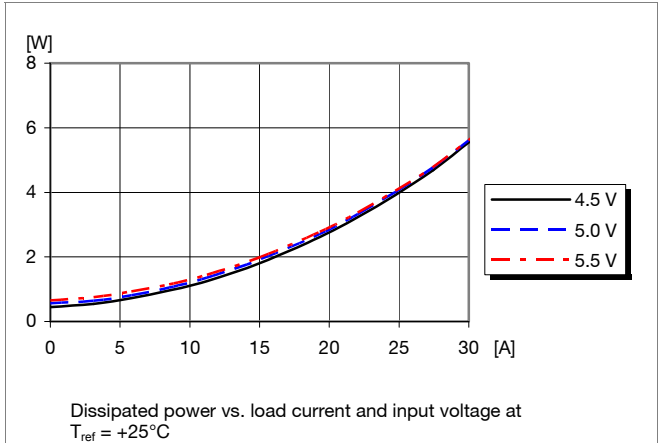

**Output Current Derating**

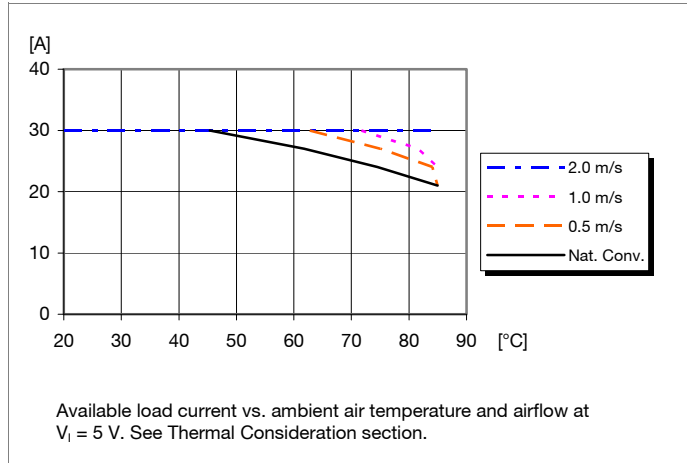

**Thermal Resistance**

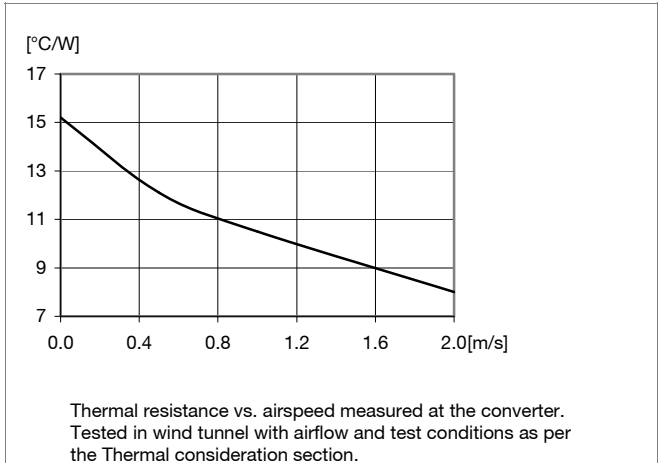

**Output Characteristics**

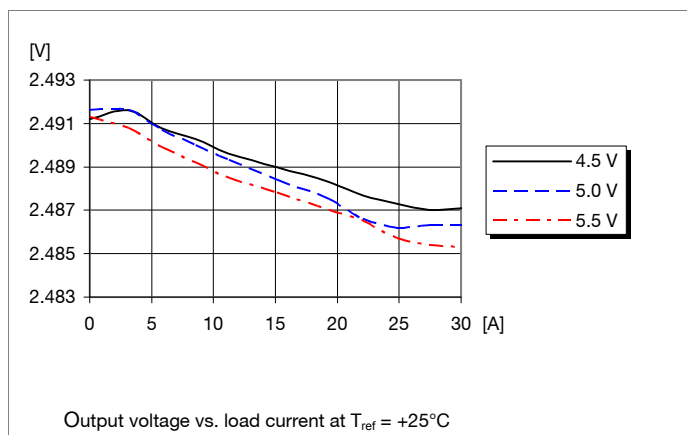

**Current Limit Characteristics**

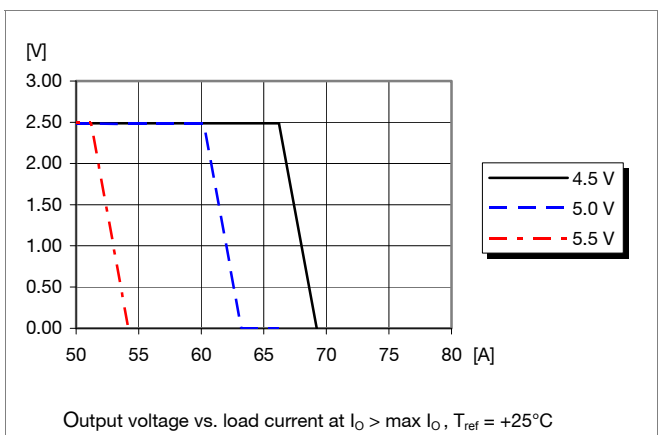

PMN 5000 series  
DC/DC regulator, Input 4.5-5.5 V, Output 30 A/108 W

EN/LZT 146 386 R1B Oct 2011

© Ericsson Power Modules AB

**2.5V, 30A / 75W Typical Characteristics**

**PMN 5118U P**

**Start-up**

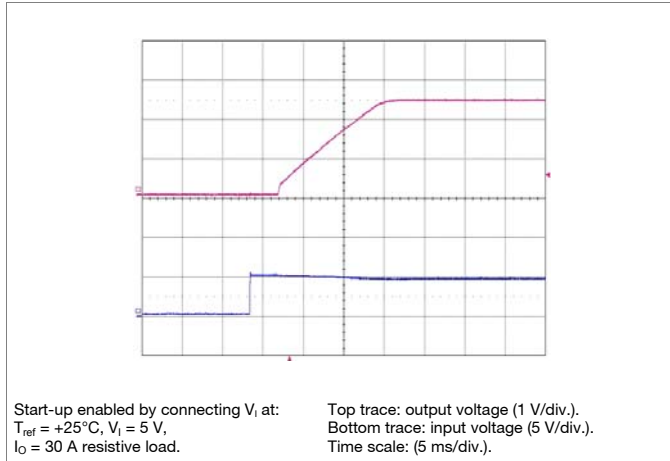

**Shut-down**

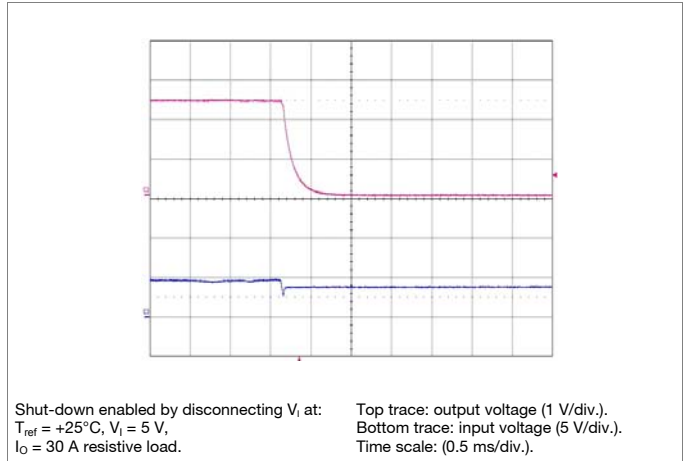

**Output Ripple & Noise**

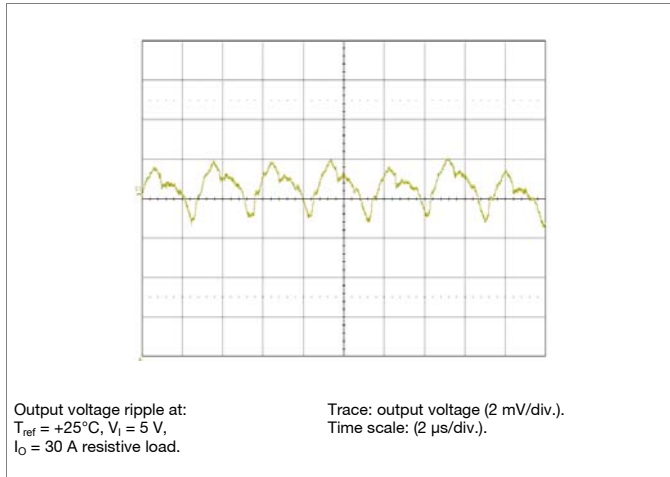

**Output Load Transient Response**

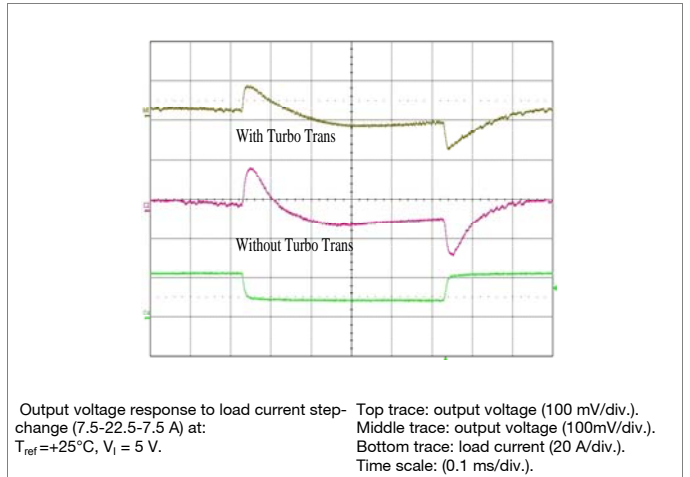

**Output Voltage Adjust (see operating information)**

**Passive adjust**

The resistor value for an adjusted output voltage is calculated by using the equations in the operating information.

$$R_{SET} = 30.1\text{ k}\Omega \times \frac{0.7}{V_o - 0.7} - 6.49\text{ k}\Omega$$

PMN 5000 series DC/DC regulator, Input 4.5-5.5 V, Output 30 A/108 W	EN/LZT 146 386 R1B Oct 2011
	© Ericsson Power Modules AB

**3.3V, 30A / 99W Electrical Specification**
**PMN 5118U P**

$T_{ref} = -40$  to  $+85^{\circ}\text{C}$ ,  $V_I = 4.5$  to  $5.5$  V,  $R_{adj} = 1.62$  k $\Omega$ , unless otherwise specified under Conditions.

Typical values given at:  $T_{ref} = +25^{\circ}\text{C}$ ,  $V_I = 5$  V, max  $I_O$ , unless otherwise specified under Conditions.

Additional  $C_{in} = 1000$   $\mu\text{F}$  and  $C_{out} = 470$   $\mu\text{F}$ . See Operating Information section for selection of capacitor types.

Connect the sense pin, where available, to the output pin.

Characteristics		Conditions	min	typ	max	Unit
$V_I$	Input voltage range		4.5	5	5.5	V
$V_{loff}$	Turn-off input voltage	Decreasing input voltage	3.9	4.1		V
$V_{lon}$	Turn-on input voltage	Increasing input voltage		4.3	4.4	V
$C_I$	Internal input capacitance			94		$\mu\text{F}$
$P_O$	Output power		0		99	W
$\eta$	Efficiency	50 % of max $I_O$		96.4		%
		max $I_O$		94.7		
$P_d$	Power Dissipation	max $I_O$		5.6	6.2	W
$P_{li}$	Input idling power	$I_O = 0$ A, $V_I = 5$ V		0.49		W
$P_{RC}$	Input standby power	$V_I = 5$ V (turned off with RC)		11.0		mW
$I_s$	Static Input current	$V_I = 5$ V, max $I_O$		20.1		A
$f_s$	Switching frequency	0-100 % of max $I_O$	600	640	680	kHz

$V_{Oi}$	Output voltage initial setting and accuracy	$T_{ref} = +25^{\circ}\text{C}$ , $V_I = 5$ V, max $I_O$	3.234	3.300	3.366	V
$V_O$	Output voltage tolerance band	10-100 % of max $I_O$	3.201		3.399	V
	Idling voltage	$I_O = 0$ A		3.288		V
	Line regulation	max $I_O$		$\pm 4$		mV
	Load regulation	$V_I = 5$ V, 0-100 % of max $I_O$		$\pm 7$		mV
$V_{tr}$	Load transient voltage deviation	$V_I = 5$ V, Load step 25-75-25 % of max $I_O$ , $di/dt = 2.5$ A/ $\mu\text{s}$		$\pm 140$		mV
$t_{tr}$	Load transient recovery time	Without Turbo Trans $C_O = 820$ $\mu\text{F}$ Type C		80		$\mu\text{s}$
$V_{tr}$	Load transient voltage deviation	$V_I = 5$ V, Load step 25-75-25 % of max $I_O$ , $di/dt = 2.5$ A/ $\mu\text{s}$		$\pm 100$		mV
$t_{tr}$	Load transient recovery time	With Turbo Trans $C_O = 820$ $\mu\text{F}$ Type C; $R_{TT} = 24$ k $\Omega$		80		$\mu\text{s}$
$t_r$	Ramp-up time (from 10-90 % of $V_O$ )	100 % of max $I_O$		10.3		ms
$t_s$	Start-up time (from $V_I$ connection to 90 % of $V_O$ )			15.0		ms
$t_f$	$V_I$ shut-down fall time. (From $V_I$ off to 10 % of $V_O$ )	Max $I_O$		1.8		ms
		$I_O = 0.1$ A		29.9		ms
$t_{RC}$ $t_{inh}$	RC start-up time	Max $I_O$		16.3		ms
	RC shut-down fall time (From RC off to 10 % of $V_O$ )	Max $I_O$		0.3		ms
		$I_O = 0.1$ A		0.5		ms
$I_O$	Output current		0		30	A
$I_{lim}$	Current limit threshold	$T_{ref} < \max T_{ref}$		68		A
$I_{sc}$	Short circuit current	$T_{ref} = 25^{\circ}\text{C}$		68		A
$V_{Oac}$	Output ripple & noise	See ripple & noise section, max $I_O$		3.9		mVp-p

PMN 5000 series  
DC/DC regulator, Input 4.5-5.5 V, Output 30 A/108 W

EN/LZT 146 386 R1B Oct 2011

© Ericsson Power Modules AB

**3.3V, 30A / 99W Typical Characteristics**

**PMN 5118U P**

**Efficiency**

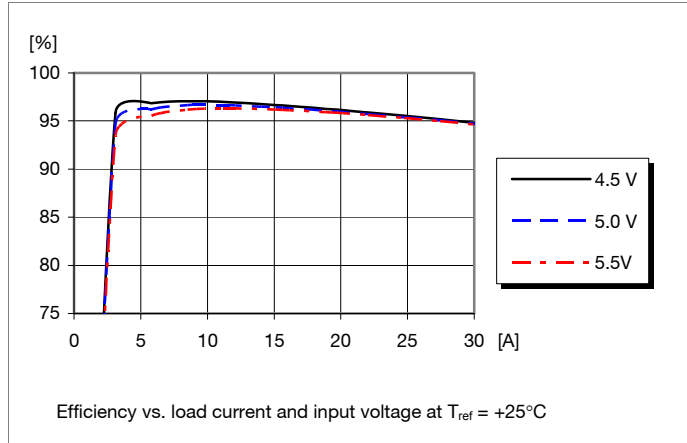

**Power Dissipation**

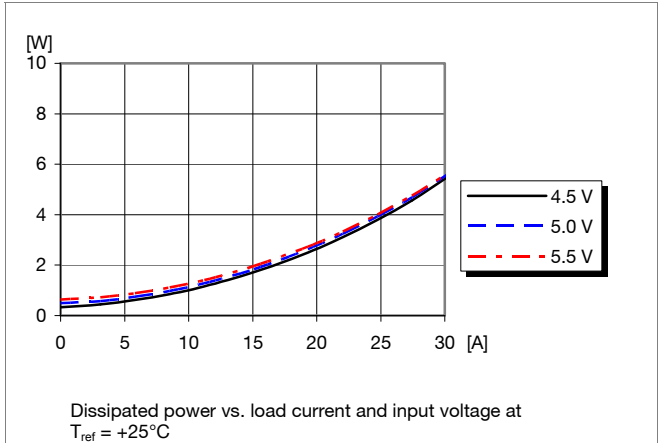

**Output Current Derating**

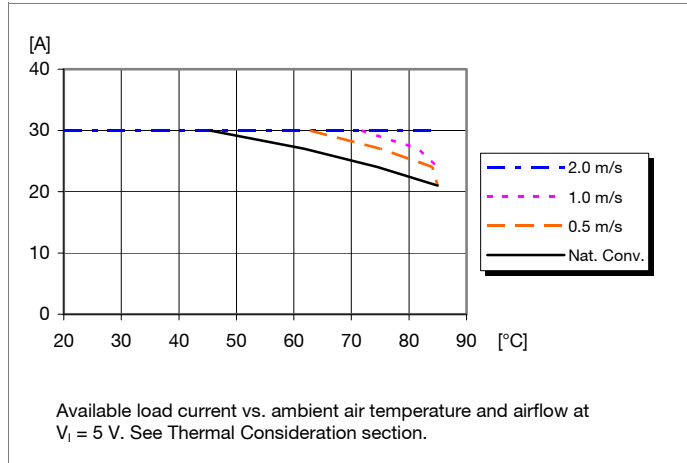

**Thermal Resistance**

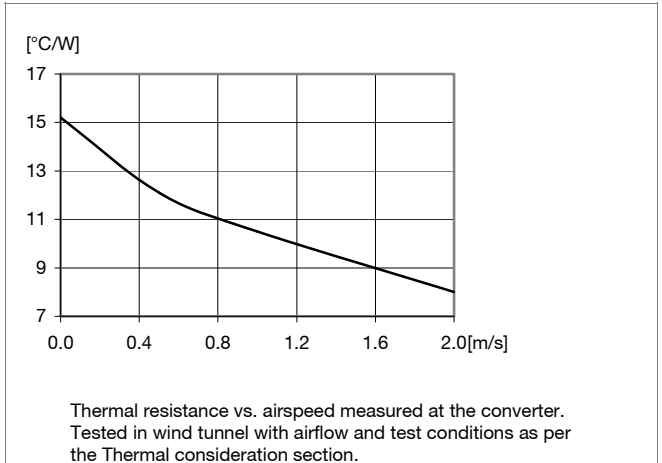

**Output Characteristics**

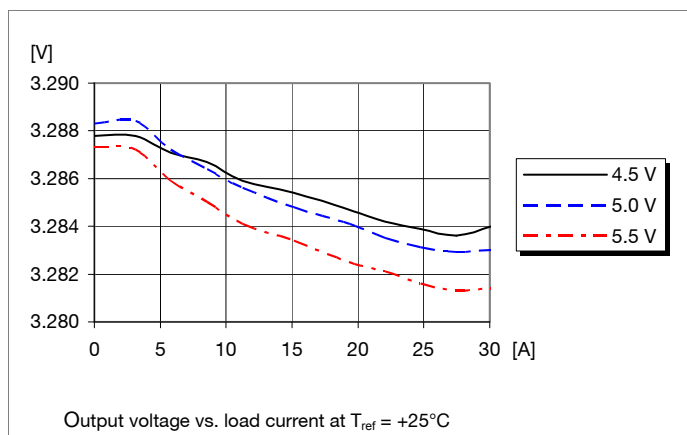

**Current Limit Characteristics**

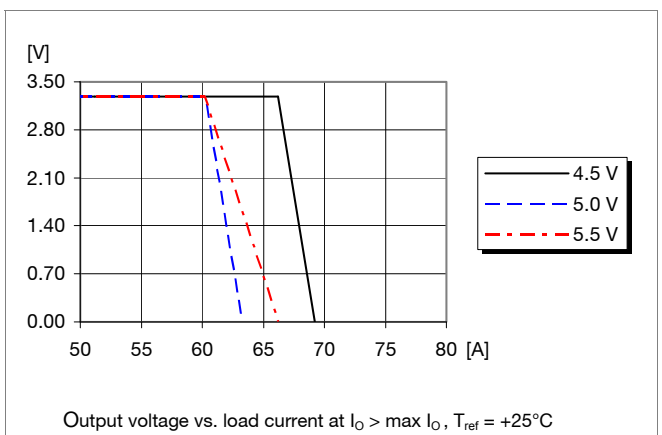



PMN 5000 series  
DC/DC regulator, Input 4.5-5.5 V, Output 30 A/108 W

EN/LZT 146 386 R1B Oct 2011

© Ericsson Power Modules AB

**3.3V, 30A / 99W Typical Characteristics**

**PMN 5118U P**

**Start-up**

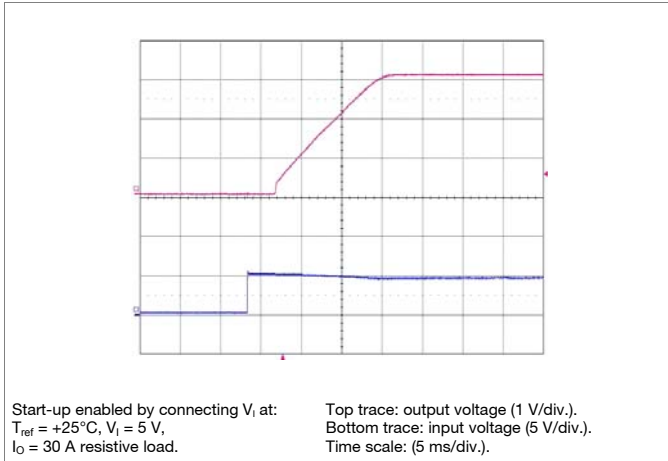

**Shut-down**

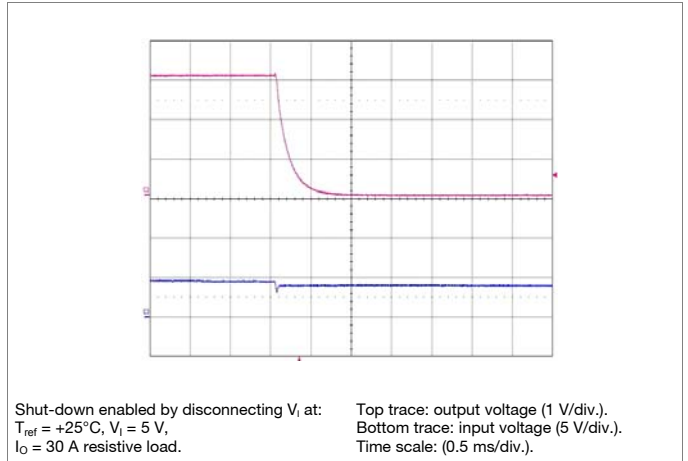

**Output Ripple & Noise**

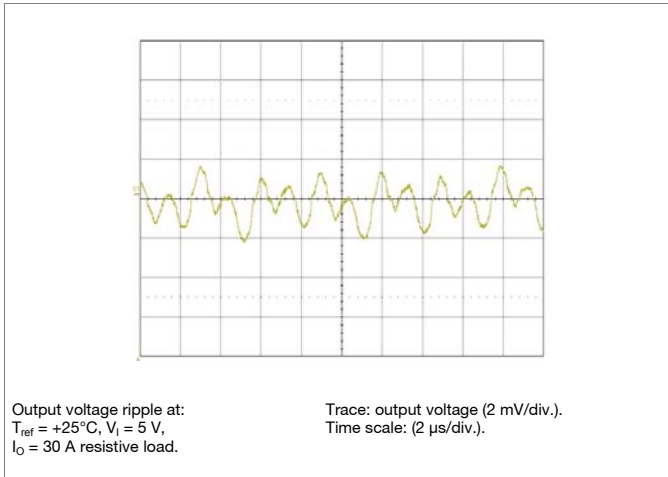

**Output Load Transient Response**

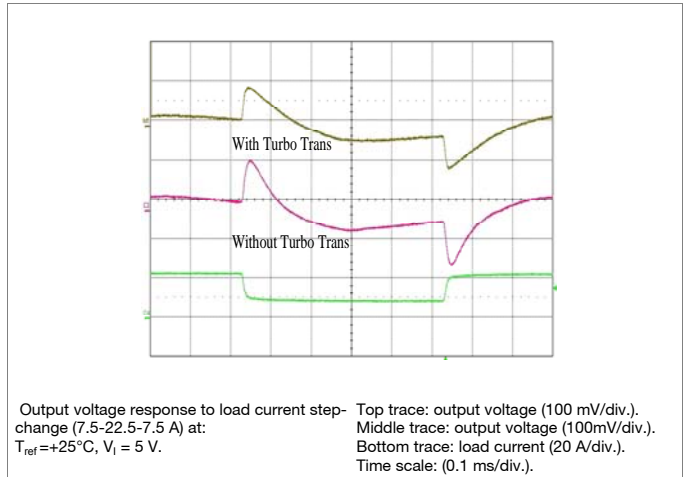

**Output Voltage Adjust (see operating information)**

**Passive adjust**

The resistor value for an adjusted output voltage is calculated by using the equations in the operating information.

$$R_{SET} = 30.1\text{ k}\Omega \times \frac{0.7}{V_o - 0.7} - 6.49\text{ k}\Omega$$

PMN 5000 series  
DC/DC regulator, Input 4.5-5.5 V, Output 30 A/108 W

EN/LZT 146 386 R1B Oct 2011

© Ericsson Power Modules AB

**EMC Specification**

Conducted EMI measured according to test set-up.  
The fundamental switching frequency is 640 kHz for  
PMN 5118U P @  $V_I = 5\text{ V}$ , max  $I_O$ .

**Conducted EMI Input terminal value (typ)**

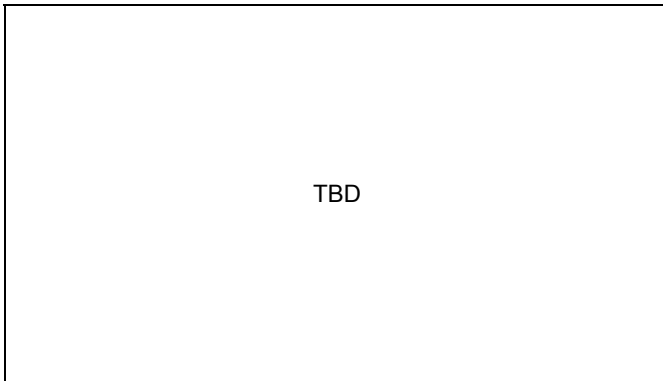

*EMI without filter*

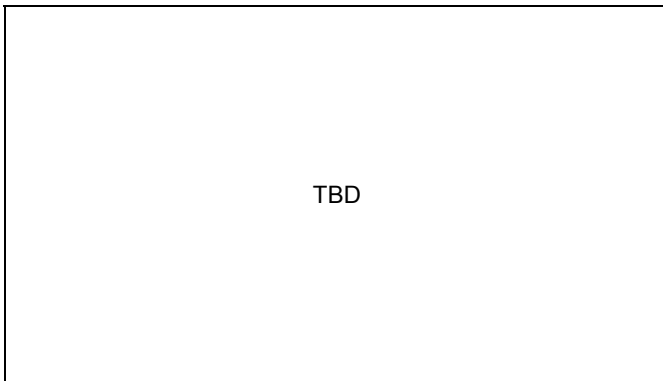

*Test set-up*

**Layout recommendation**

The radiated EMI performance of the DC/DC regulator will depend on the PCB layout and ground layer design. It is also important to consider the stand-off of the DC/DC regulator.  
If a ground layer is used, it should be connected to the output of the DC/DC regulator and the equipment ground or chassis.

A ground layer will increase the stray capacitance in the PCB and improve the high frequency EMC performance.

**Output ripple and noise**

Output ripple and noise measured according to figure below. See Design Note 022 for detailed information.

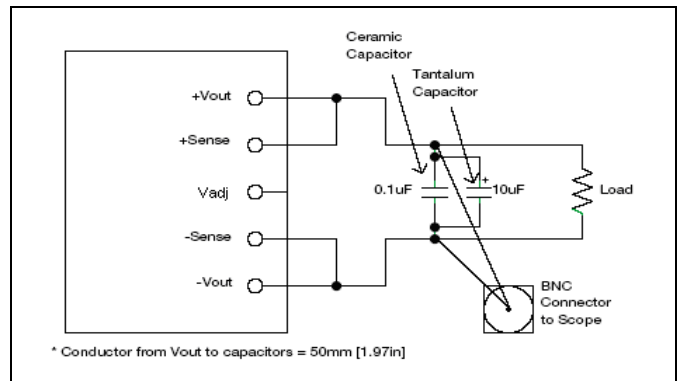

*Output ripple and noise test setup*

**Operating information**

Extended information for POLA products is found in Application Note 205.

**Input Voltage**

The input voltage range 4.5 to 5.5 Vdc makes the product easy to use in intermediate bus applications when powered by a regulated bus converter.

**Turn-off Input Voltage**

The DC/DC regulators monitor the input voltage and will turn on and turn off at predetermined levels. The minimum hysteresis between turn on and turn off input voltage is 0.1V.

**Remote Control (RC) Inhibit**

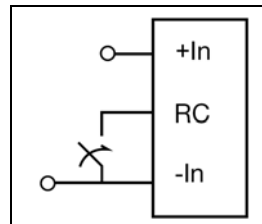

The products are fitted with a remote control function referenced to positive logic. The RC function allows the regulator to be turned on/off by an external device like a semiconductor or mechanical switch. The RC pin has an internal pull up resistor to + In.

The maximum required sink current is 1 mA. When the RC pin is left open, the voltage generated on the RC pin is 4.5-5.5 V. The regulator will turn on when the input voltage is applied with the RC pin open. Turn off is achieved by connecting the RC pin to the - In. To ensure safe turn off the voltage difference between RC pin and the - In pin shall be less than 1V. The regulator will restart automatically when this connection is opened.

PMN 5000 series  
DC/DC regulator, Input 4.5-5.5 V, Output 30 A/108 W

EN/LZT 146 386 R1B Oct 2011

© Ericsson Power Modules AB

**External Capacitors**

**Input capacitors:**

The recommended input capacitors are determined by the 1000 µF minimum capacitance and 1000 mArms minimum ripple current rating.

For high-performance/transient application, or wherever the input source performance is degraded, 2000 µF of input capacitance is recommended. The additional input capacitance above the minimum level insures an optimized performance.

**Output capacitors:**

The recommended output capacitance of 470 µF will allow the module to meet its transient response specification as defined in the electrical specification.

When using one or more non-ceramic capacitors, the calculated equivalent ESR should be no lower than 4 mΩ (7mΩ using the manufacturer’s maximum ESR for a single capacitor).

Turbo Trans™ allows the designer to optimize the capacitance load according to the system transient design requirement. High quality, ultra-low ESR capacitors are required to maximize Turbo Trans™ effectiveness. Capacitors with a capacitance (µF)×ESR (mΩ) ≤ 10,000 mΩ × µF are required.

Required Capacitor with Turbo Trans™. See the Turbo Trans™ Application information for Capacitor Selection.

**Capacitor Type Group by ESR (Equivalent Series Resistance)**

Type A = (100<capacitance×ESR≤1,000)

Type B = (1,000<capacitance×ESR≤5,000)

Type C = (5,000<capacitance×ESR≤10,000)

**Input And Output Impedance**

The impedance of both the input source and the load will interact with the impedance of the DC/DC regulator. It is important that the input source has low characteristic impedance. The regulators are designed for stable operation without external capacitors connected to the input or output. The performance in some applications can be enhanced by addition of external capacitance as described under External Decoupling Capacitors. If the input voltage source contains significant inductance, the addition of a 100 µF capacitor across the input of the regulator will ensure stable operation. The capacitor is not required when powering the DC/DC regulator from an input source with an inductance below 10 µH.

**External Decoupling Capacitors**

When powering loads with significant dynamic current requirements, the voltage regulation at the point of load can be improved by addition of decoupling capacitors at the load.

The most effective technique is to locate low ESR ceramic and electrolytic capacitors as close to the load as possible, using several parallel capacitors to lower the effective ESR. The ceramic capacitors will handle high-frequency dynamic load changes while the electrolytic capacitors are used to handle low frequency dynamic load changes. Ceramic capacitors will also reduce any high frequency noise at the load.

It is equally important to use low resistance and low inductance PCB layouts and cabling.

External decoupling capacitors will become part of the control loop of the DC/DC regulator and may affect the stability margins. As a “rule of thumb”, 100 µF/A of output current can be added without any additional analysis. The ESR of the capacitors is a very important parameter. Power Modules guarantee stable operation with a verified ESR value of >10 mΩ across the output connections.

For further information please contact your local Ericsson Power Modules representative.

**Output Voltage Adjust (V<sub>adj</sub>)**

The DC/DC regulators have an Output Voltage Adjust pin (V<sub>adj</sub>). This pin can be used to adjust the output voltage above or below Output voltage initial setting.

To increase or decrease the voltage, the resistor should be connected between the V<sub>adj</sub> pin and GND pin. The resistor value of the output voltage adjust function is according to information given under the output section for the respective product.

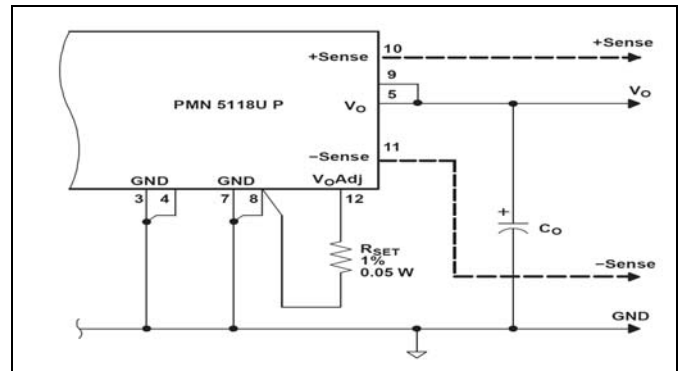

**Parallel Operation**

Two regulators may be paralleled for redundancy if the total power is equal or less than P<sub>O</sub> max. It is not recommended to parallel the regulators without using external current sharing circuits.

**Remote Sense**

The DC/DC regulators have remote sense that can be used to compensate for voltage drops between the output and the point of load. The sense traces should be located close to the PCB ground layer to reduce noise susceptibility. The remote sense circuitry will compensate for up to 10% voltage drop between output pins and the point of load.

PMN 5000 series  
DC/DC regulator, Input 4.5-5.5 V, Output 30 A/108 W

EN/LZT 146 386 R1B Oct 2011

© Ericsson Power Modules AB

If the remote sense is not needed +Sense should be connected to +Out and -Sense should be connected to -Out.

**Over Temperature Protection (OTP)**

The regulators are protected from thermal overload by an internal over temperature shutdown circuit. When  $T_{ref}$  as defined in thermal consideration section exceeds the OTP threshold, the regulator will shut down. The DC/DC regulator will make continuous attempts to start up (non-latching mode) and resume normal operation automatically when the temperature has dropped  $>10^{\circ}C$  below the temperature threshold.

**Over Current Protection (OCP)**

The regulators include current limiting circuitry for protection at continuous overload. The output voltage will decrease towards zero for output currents in excess of max output current (max  $I_o$ ). The regulator will resume normal operation after removal of the overload. The load distribution should be designed for the maximum output short circuit current specified.

**Soft-start Power Up**

From the moment a valid input voltage is applied, the soft-start control introduces a short time-delay (typically 5-10 ms) before allowing the output voltage to rise. The initial rise in input current when the input voltage first starts to rise is the charge current drawn by the input capacitors. Power-up is complete within 15 ms.

**Auto Track™ Function**

Auto Track™ was designed to simplify the amount of circuitry required to make the output voltage from each module power up and power down in sequence. The sequencing of two or more supply voltages during power up is a common requirement for complex mixed-signal applications, that use dual-voltage VLSI ICs such as DSPs, micro-processors and ASICs.

**Adjustable Undervoltage Lockout**

The regulators incorporate an input undervoltage lockout (UVLO). The UVLO feature prevents the operation of the module until there is a sufficient input voltage to produce a valid output voltage. This enables the module to provide a clean, monotonic powerup for the load circuit and also limit the magnitude of current drawn from regulator's input source during the power-up sequence.

The UVLO characteristic is defined by the ON threshold ( $V_{THD}$ ) voltage. Below the ON threshold, the Inhibit control is overridden, and the module does not produce an output. The hysteresis voltage, which is the difference oscillations, which can occur if the input voltage drops slightly when the modules begins to draw current from the input source.

The UVLO feature of the PMN 5118U P module allows for limited adjustment of the ON threshold voltage. The adjustment is made via the Inhibit/UVLO Prog control pin (Pin

1) using a single resistor (see figure below). When pin 1 is left open, the ON threshold voltage is internally set to its default value. The ON threshold has a nominal voltage of 4.25 V and a hysteresis of 150 mV.

The below equation determines the value of  $R_{UVLO}$  required to adjust  $V_{THD}$  to a new value. The default value is 4.25 V and it may only be adjusted to a higher value.

$$R_{UVLO} = \frac{101 - V_{THD}}{V_{THD} - 1} \quad (K\Omega)$$

Standard Values of  $R_{UVLO}$  for Various Values of  $V_{THD}$

$V_{THD}$	5.00 V	4.75 V	4.50 V	4.25 V
$R_{UVLO}$	24.3 k $\Omega$	25.5 k $\Omega$	27.57 k $\Omega$	OPEN

The above table lists the standard resistor values for  $R_{UVLO}$  for different values of the ON threshold ( $V_{THD}$ ) voltage. The figure of UVLO Program Resistor Placement is as follow.

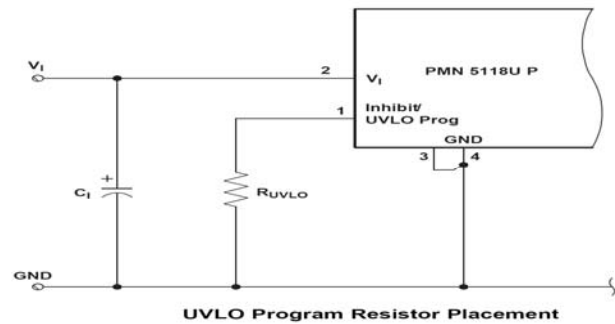

**Turbo Trans™ Technology**

Turbo Trans™ optimizes the transient response of the regulator with added external capacitance using a single external resistor. The benefits of this technology include: reduced output capacitance, minimized output voltage deviation following a load transient, and enhanced stability when using ultra-low ESR output capacitors. The amount of output capacitance required to meet a target output voltage deviation, is reduced with Turbo Trans™ activated. Likewise, for a given amount of output capacitance, with Turbo Trans™ engaged, the amplitude of the voltage deviation following a load transient is reduced. Applications requiring tight transient voltage tolerances and minimized capacitor footprint area benefit from this technology.

Utilizing Turbo Trans™ requires connecting a resistor,  $R_{TT}$ , between the +Sense pin (pin 10) and the Turbo Trans™ pin (pin 13). The value of the resistor directly corresponds to the amount of output capacitance required. For the PMN 5118U P, the minimum required capacitance is 470  $\mu F$ . When using Turbo Trans™, capacitors with a capacitance $\times$ ESR product below 10,000  $\mu F \times m\Omega$  are required.

To see the benefit of Turbo Trans™, follow the 4mV/A marking

PMN 5000 series  
DC/DC regulator, Input 4.5-5.5 V, Output 30 A/108 W

EN/LZT 146 386 R1B Oct 2011

© Ericsson Power Modules AB

across to the “Without Turbo Trans™” plot. Following that point down shows that more than 10,000 µF of output capacitance is required to meet the same transient deviation limit. This is the benefit of Turbo Trans™. A typical Turbo Trans™ application schematic is also shown.

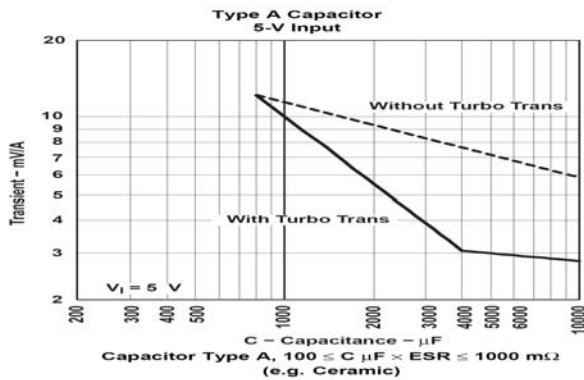

Type A TurboTrans C<sub>0</sub> Values & Required R<sub>TT</sub> Selection Table

Transient Voltage Deviation (mV)			5-V Input	
25% Load Step (7.5 A)	50% Load Step (15 A)	75% Load Step (22.5 A)	C <sub>0</sub> Minimum Required Output Capacitance (µF)	R <sub>TT</sub> Required TurboTrans Resistor (kΩ)
90	180	270	800	open
80	160	240	950	165
70	140	210	1100	75.0
60	120	180	1350	40.2
50	100	150	1650	22.1
40	80	120	2150	11.3
30	60	90	3000	3.65
25	40	60	3700	0.825

**R<sub>TT</sub> Resistor Selection**

The Turbo Trans™ resistor value, R<sub>TT</sub> can be determined from the Turbo Trans™ programming equation, see the equation below.

$$R_{TT} = 40 \times \frac{1 - \left(\frac{C_o}{4000}\right)}{5 \times \left(\frac{C_o}{4000}\right) - 1} (k\Omega)$$

Where C<sub>o</sub> is the total output capacitance in µF. C<sub>o</sub> values greater than or equal to 4000 µF require R<sub>TT</sub> to be a short, 0Ω. (The above equation results in a negative value for R<sub>TT</sub> when C<sub>o</sub> ≥ 4000 µF)

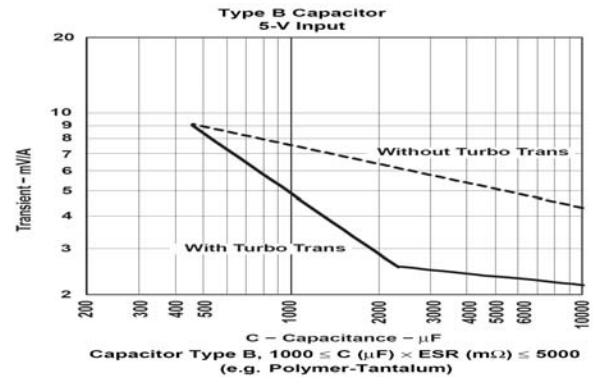

Type B TurboTrans C<sub>0</sub> Values & Required R<sub>TT</sub> Selection Table

Transient Voltage Deviation (mV)			5-V Input	
25% Load Step (7.5 A)	50% Load Step (15 A)	75% Load Step (22.5 A)	C <sub>0</sub> Minimum Required Output Capacitance (µF)	R <sub>TT</sub> Required TurboTrans Resistor (kΩ)
70	140	210	470	open
60	120	180	560	174
50	100	150	700	57.6
40	80	120	950	24.9
35	70	105	1100	15.8
30	60	90	1350	9.31
25	50	75	1700	4.42
20	40	60	2250	0.523

**R<sub>TT</sub> Resistor Selection**

The Turbo Trans™ resistor value, R<sub>TT</sub> can be determined from the Turbo Trans™ programming equation, see the equation below.

$$R_{TT} = 40 \times \frac{1 - \left(\frac{C_o}{2350}\right)}{5 \times \left(\frac{C_o}{2350}\right) - 1} (k\Omega)$$

Where C<sub>o</sub> is the total output capacitance in µF. C<sub>o</sub> values greater than or equal to 2350 µF require R<sub>TT</sub> to be a short, 0Ω. (The above equation results in a negative value for R<sub>TT</sub> when C<sub>o</sub> ≥ 2350 µF)

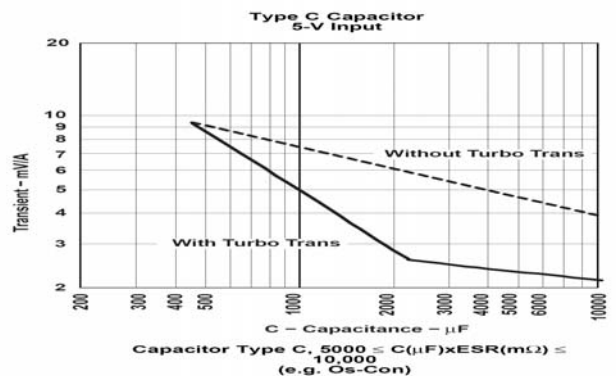



PMN 5000 series  
DC/DC regulator, Input 4.5-5.5 V, Output 30 A/108 W

EN/LZT 146 386 R1B Oct 2011

© Ericsson Power Modules AB

Type C TurboTrans C<sub>o</sub> Values & Required R<sub>TT</sub> Selection Table

Transient Voltage Deviation (mV)			5-V Input	
25% Load Step (7.5 A)	50% Load Step (15 A)	75% Load Step (22.5 A)	C <sub>o</sub> Minimum Required Output Capacitance (μF)	R <sub>TT</sub> Required TurboTrans Resistor (kΩ)
70	140	210	470	open
60	120	180	600	130
50	100	150	750	51.1
40	80	120	950	22.6
35	70	105	1150	14.3
30	60	90	1400	8.45
25	50	75	1750	3.83
20	40	60	2300	0.182

**R<sub>TT</sub> Resistor Selection**

The Turbo Trans<sup>TM</sup> resistor value, R<sub>TT</sub> can be determined from the Turbo Trans<sup>TM</sup> programming equation, see the equation below.

$$R_{TT} = 40 \times \frac{1 - \left(\frac{C_o}{2350}\right)}{5 \times \left(\frac{C_o}{2350}\right) - 1} (k\Omega)$$

Where C<sub>o</sub> is the total output capacitance in μF. C<sub>o</sub> values greater than or equal to 2350 μF require R<sub>TT</sub> to be a short, 0Ω. (The above equation results in a negative value for R<sub>TT</sub> when C<sub>o</sub> ≥ 2350 μF)

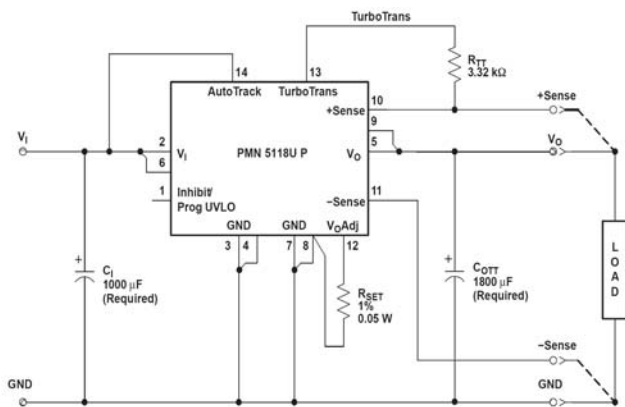

Typical TurboTrans Application Schematic

**Thermal Consideration**

**General**

The regulators are designed to operate in different thermal environments and sufficient cooling must be provided to ensure reliable operation.

Cooling is achieved mainly by conduction, from the pins to the host board, and convection, which is dependant on the airflow across the regulator. Increased airflow enhances the cooling of the regulator.

The Output Current Derating graph found in the Output section for each model provides the available output current vs. ambient air temperature and air velocity at V<sub>in</sub> = 5 V.

The DC/DC regulator is tested on a 254 x 254 mm, 35 μm (1 oz), 8-layer test board mounted vertically in a wind tunnel with a cross-section of 305 x 305 mm.

Proper cooling of the DC/DC regulator can be verified by measuring the temperature at positions P1, P2 and P3. The temperature at these positions should not exceed the max values provided in the table below.

Note that the max value is the absolute maximum rating (non destruction) and that the electrical Output data is guaranteed up to ambient temperature +85°C.

See Design Note 019 for further information.

Position	Device	Designation	max value
P1	Pcb		130° C
P2	Mosfet		130° C
P3	Inductor	T <sub>ref</sub>	130° C

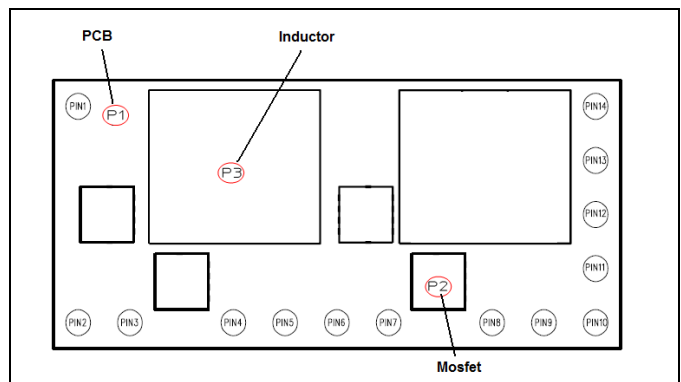

PMN 5000 series  
DC/DC regulator, Input 4.5-5.5 V, Output 30 A/108 W

EN/LZT 146 386 R1B Oct 2011

© Ericsson Power Modules AB

**Thermal Consideration continued**

**Definition of reference temperature (T<sub>ref</sub>)**

The reference temperature is used to monitor the temperature limits of the product. Temperatures above maximum T<sub>ref</sub> are not allowed and may cause degradation or permanent damage to the product. T<sub>ref</sub> is also used to define the temperature range for normal operating conditions.

T<sub>ref</sub> is defined by the design and used to guarantee safety margins, proper operation and high reliability of the module.

**Ambient Temperature Calculation**

By using the thermal resistance the maximum allowed ambient temperature can be calculated.

1. The power loss is calculated by using the formula  
 $((1/\eta) - 1) \times \text{output power} = \text{power losses (Pd)}$   
 $\eta$  = efficiency of regulator. E.g 89.5 % = 0.895

2. Find the thermal resistance (R<sub>th</sub>) in the Thermal Resistance graph found in the Output section for each model.  
 Calculate the temperature increase ( $\Delta T$ ).  
 $\Delta T = R_{th} \times P_d$

3. Max allowed ambient temperature is:  
 Max T<sub>ref</sub> -  $\Delta T$ .

E.g PMN 5118U P at 0m/s:

1.  $((\frac{1}{0.947}) - 1) \times 99 \text{ W} = 5.54 \text{ W}$

2.  $5.54 \text{ W} \times 15.2^\circ\text{C/W} = 84.2^\circ\text{C}$

3.  $130^\circ\text{C} - 84.2^\circ\text{C} = \text{max ambient temperature is } 45.8^\circ\text{C}$

The actual temperature will be dependent on several factors such as the PCB size, number of layers and direction of airflow.

**Connections**

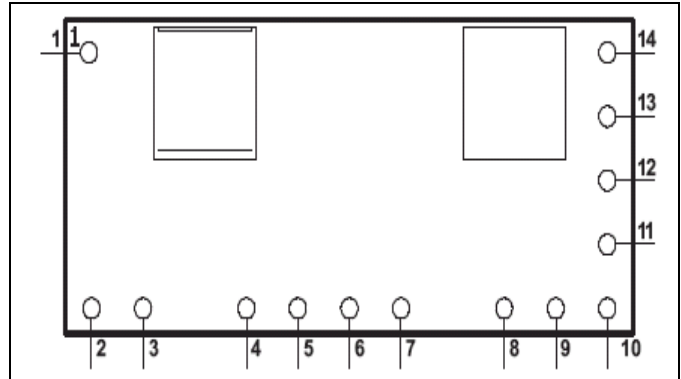

Pin	Designation	Function
1	Inhibit/ UVLO Adjust	The Inhibit pin is an open-collector/drain, negative logic input that is referenced to GND. Applying a low level ground signal to this input disables the module's output voltage. If the Inhibit pin is left open-circuit, the module produces an output whenever a valid input source is applied. This input is not compatible with TTL logic devices and should not be tied V <sub>i</sub> or other voltage. This pin is also used for input undervoltage lockout (UVLO) programming. Connecting a resistor from this pin to GND (Pin 3) allows the ON threshold of the UVLO to be adjusted higher than the default value.
2	V <sub>i</sub>	The positive input voltage power node to the module, which is referenced to common GND.
3	GND	This is the common ground connection for the V <sub>i</sub> and V <sub>o</sub> power connections. It is also the 0 V <sub>dc</sub> reference for the control inputs.
4	GND	This is the common ground connection for the V <sub>i</sub> and V <sub>o</sub> power connections. It is also the 0 V <sub>dc</sub> reference for the control inputs.
5	V <sub>o</sub>	The regulated positive power output with respect to the GND.
6	V <sub>i</sub>	The positive input voltage power node to the module, which is referenced to common GND.

PMN 5000 series DC/DC regulator, Input 4.5-5.5 V, Output 30 A/108 W	EN/LZT 146 386 R1B Oct 2011
	© Ericsson Power Modules AB

7	GND	This is the common ground connection for the $V_I$ and $V_o$ power connections. It is also the 0 $V_{dc}$ reference for the control inputs.	14 Track This is an analog control input that enables the output voltage to follow an external voltage. This pin becomes active typically 20 ms after the input voltage has been applied, and allows direct control of the output voltage from 0 V up to the nominal set-point voltage. Within the control voltage is raised above this range, the module regulates at its set-point voltage. The features allows the output voltage to rise simultaneously with other modules powered from the same input bus. If unused, this input should be connected to $V_I$ . NOTE: Due to the undervoltage lockout feature, the output of the module cannot follow its own input voltage during power up. For more information, see the related application note.
8	GND	This is the common ground connection for the $V_I$ and $V_o$ power connections. It is also the 0 $V_{dc}$ reference for the control inputs.	
9	$V_o$	The regulated positive power output with respect to the GND.	
10	+Sense	The sense input allows the regulation circuit to compensate for voltage drop between the module and the load. For optimal voltage accuracy, +Sense must be connect $V_o$ , very close to the load.	
11	-Sense	The sense input allows the regulation circuit to compensate for voltage drop between the module and the load. For optimal voltage accuracy, -Sense must be connect GND(pin 8), very close to the load.	
12	$V_o$ Adjust	A 0.1 W 1% resistor must be directly connected between this pin and pin 8 (GND) to set the output voltage to a value higher than 0.7 V. The temperature stability of the resistor should be 100 ppm/°C (or better). The setpoint range for the output voltage is from 0.7V to 3.6V. If left open circuit, the output voltage defaults to its lowest value. For further information, on output voltage adjustment see the related application note. The specification table gives the preferred resistor values for a number of standard output voltages.	
13	Turbo Trans	This input pin adjusts the transient response of the regulator. To activate the Turbo Trans™ feature, a 1%, 50mW resistor must be connected between this pin and pin 10 (+Sense) very close to the module. For a given value of output capacitance, a reduction in peak output voltage deviation is achieved by using this feature. If unused, this pin must be left open-circuit. External capacitance must never be connected to this pin. The resistance requirement can be selected from the Turbo Trans™ resistor table in the Application Information section.	



PMN 5000 series  
DC/DC regulator, Input 4.5-5.5 V, Output 30 A/108 W

EN/LZT 146 386 R1B Oct 2011

© Ericsson Power Modules AB

**Mechanical Information (surface mount versions)**

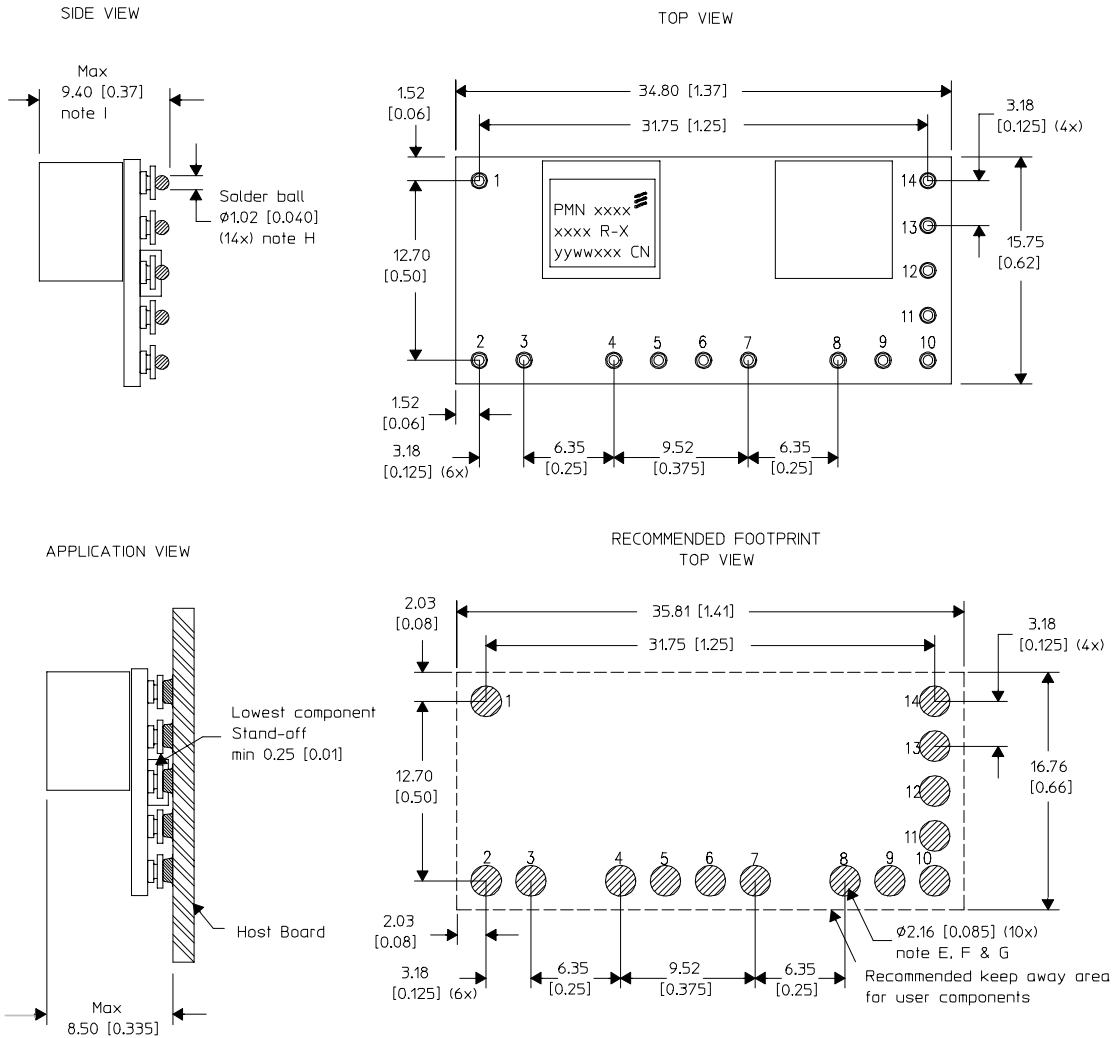

Notes:

- A. All linear dimensions are mm [inch].
- B. This drawing is subject to change without notice.
- C. 1 place decimals are  $\pm 0.75$  [ $\pm 0.030$ ]
- D. 2 place decimals are  $\pm 0.25$  [ $\pm 0.010$ ]
- E. Power pin connection should utilize two or more vias to the interior power plane of  $\varnothing 0.63$  [0.025] per input, ground and output pin ( or the electrical equivalent ).

- F. Paste screen opening:  $\varnothing 2.03$  [0.080] to  $\varnothing 2.16$  [0.085]  
Paste screen thickness: 0.15 [0.006]
- G. Pad type: solder mask defined
- H. All pins: Material - Copper Alloy  
Plating - 10  $\mu$ m Tin over 4  $\mu$ m Nickel  
Solder Ball - Black collar 63 Sn / 37 Pb  
Blue collar 96.5 Sn / 3.0 Ag / 0.5 Cu
- I. Dimension prior to reflow solder.

MECHANICAL DATA FOR THE PMN DC/DC REGULATOR

Weight: typical 8 g

Use recommended footprint and solder recommendations together with solder reflow recommendations to ensure a reliable interconnection.

PMN 5000 series  
DC/DC regulator, Input 4.5-5.5 V, Output 30 A/108 W

EN/LZT 146 386 R1B Oct 2011  
© Ericsson Power Modules AB

**Mechanical Information (Through hole mount version)**

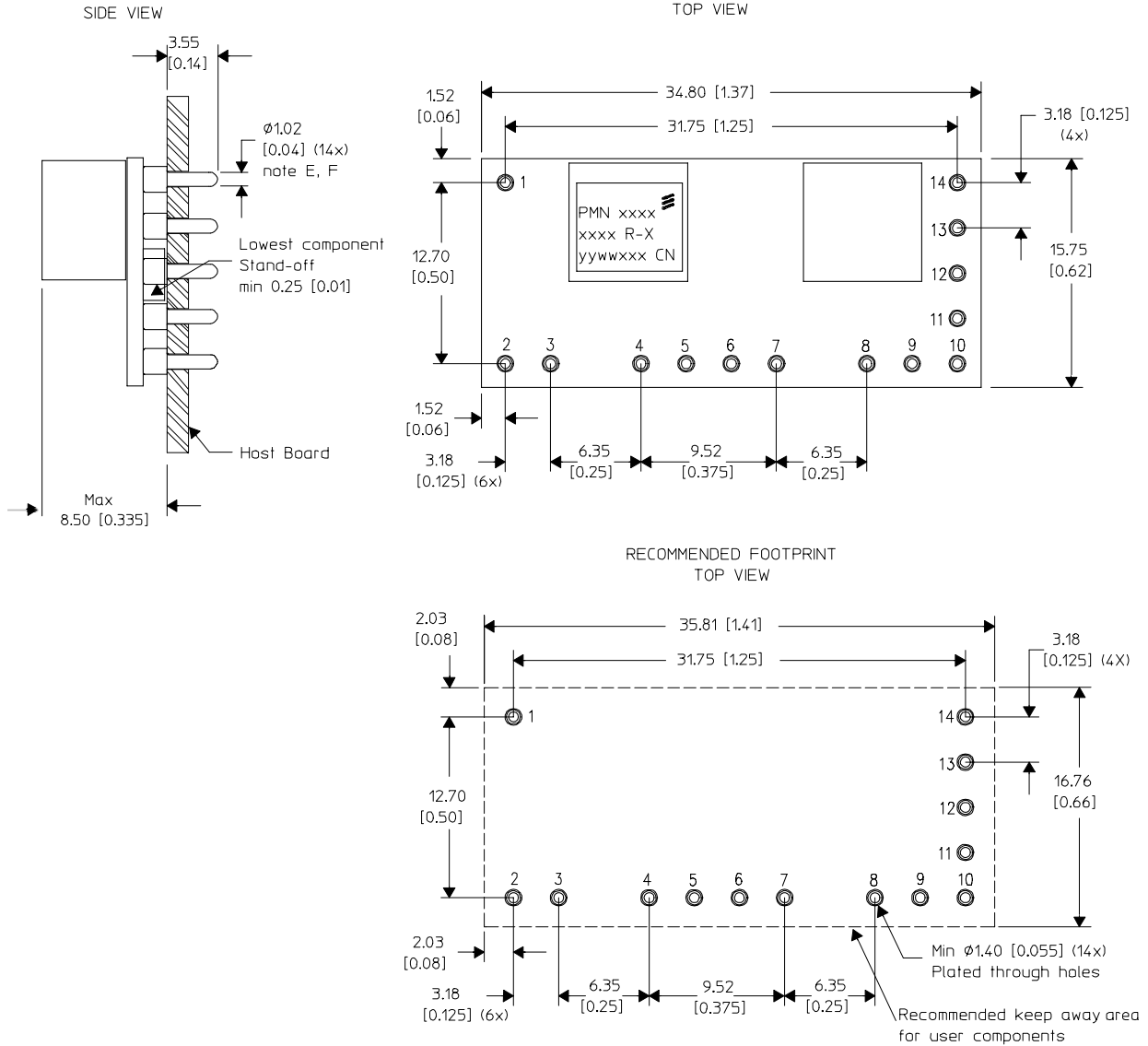

- Notes:
- A. All linear dimensions are mm [inch].
  - B. This drawing is subject to change without notice.
  - C. 1 place decimals are  $\pm 0.75$  [ $\pm 0.030$ ]
  - D. 2 place decimals are  $\pm 0.25$  [ $\pm 0.010$ ]
  - E. Pins are  $\phi 1.02$  [0.040] with  $\phi 1.78$  [0.070] stand-off shoulder.
  - F. All pins: Material - Copper Alloy  
Finish - 10  $\mu$ m Tin over 4  $\mu$ m Nickel

MECHANICAL DATA FOR THE PMN DC/DC REGULATOR  
Weight: typical 8 g

Use recommended footprint and solder recommendations together with solder reflow recommendations to ensure a reliable interconnection.

PMN 5000 series  
DC/DC regulator, Input 4.5-5.5 V, Output 30 A/108 W

EN/LZT 146 386 R1B Oct 2011

© Ericsson Power Modules AB

**Soldering Information - Surface Mounting**

The surface mount version of the product is intended for convection or vapor phase reflow SnPb or Pb-free processes. To achieve a good and reliable soldering result, make sure to follow the recommendations from the solder paste supplier, to use state-of-the-art reflow equipment and reflow profiling techniques as well as the following guidelines.

A no-clean flux is recommended to avoid entrapment of cleaning fluids in cavities inside the product or between the product and the host board. The cleaning residues may affect long time reliability and isolation voltage.

**Minimum Pin Temperature Recommendations**

Pin number 5 is chosen as reference location for the minimum pin temperature recommendations since this will likely be the coolest solder joint during the reflow process.

Pin 5 for measurement of minimum solder joint temperature,  $T_{PIN}$

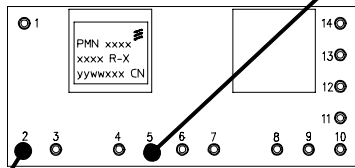

Pin 2 for measurement of maximum peak product reflow temperature,  $T_P$

**SnPb solder processes**

For SnPb solder processes, a pin temperature ( $T_{PIN}$ ) in excess of the solder melting temperature, ( $T_L$ , +183°C for Sn63/Pb37) for more than 30 seconds, and a peak temperature of +210°C is recommended to ensure a reliable solder joint.

**Lead-free (Pb-free) solder processes**

For Pb-free solder processes, a pin temperature ( $T_{PIN}$ ) in excess of the solder melting temperature ( $T_L$ , +217 to +221°C for Sn/Ag/Cu solder alloys) for more than 30 seconds, and a peak temperature of +235°C on all solder joints is recommended to ensure a reliable solder joint.

**Peak Product Temperature Requirements**

Pin 2 is chosen as reference location for the maximum (peak) allowed product temperature ( $T_P$ ) since this will likely be the warmest part of the product during the reflow process.

To avoid damage or performance degradation of the product, the reflow profile should be optimized to avoid excessive heating. A sufficiently extended preheat time is recommended to ensure an even temperature across the host PCB, for both small and large devices. To reduce the risk of excessive heating is also recommended to reduce the time in the reflow zone as much as possible.

**SnPb solder processes**

For SnPb solder processes, the product is qualified for MSL 1 according to IPC/JEDEC standard J-STD-020C.

During reflow,  $T_P$  must not exceed +225°C at any time.

**Lead-free (Pb-free) solder processes**

For Pb-free solder processes, the product is qualified for MSL 3 according to IPC/JEDEC standard J-STD-020C.

During reflow,  $T_P$  must not exceed +260°C at any time.

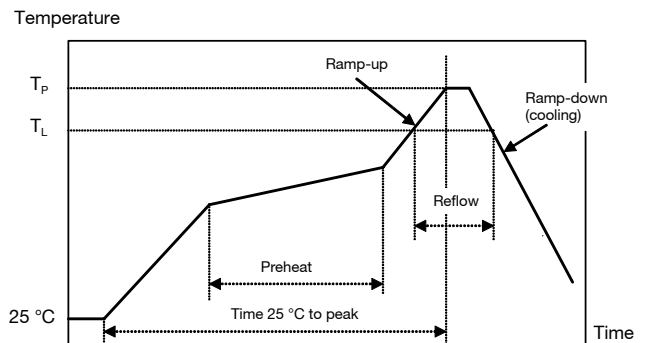

Reflow process specifications		Sn/Pb eutectic	Pb-free
Average ramp-up rate		3 °C/s max	3 °C/s max
Solder melting temperature (typical)	$T_L$	+183°C	+221°C
Minimum time above $T_L$		30 s	30 s
Minimum pin temperature	$T_{PIN}$	+210°C	+235°C
Peak product temperature	$T_P$	+225°C	+260°C
Average ramp-down rate		6°C/s max	6°C/s max
Time 25 °C to peak		6 minutes max	8 minutes max

PMN 5000 series  
DC/DC regulator, Input 4.5-5.5 V, Output 30 A/108 W

EN/LZT 146 386 R1B Oct 2011

© Ericsson Power Modules AB

**Soldering Information – Through Hole Mounting**

The through hole mount version of the product is intended for manual or wave soldering. When wave soldering is used, the temperature on the pins is specified to maximum 270 °C for maximum 10 seconds.

A maximum preheat rate of 4°C/s and a temperature of max of +150°C is suggested. When soldering by hand, care should be taken to avoid direct contact between the hot soldering iron tip and the pins for more than a few seconds in order to prevent overheating.

A no-clean flux is recommended to avoid entrapment of cleaning fluids in cavities inside the product or between the product and the host board. The cleaning residues may affect long time reliability and isolation voltage.

**Delivery Package Information**

The TH version products are delivered in antistatic trays. The SMD version products are delivered in antistatic trays and antistatic carrier tape (EIA 481 standard).

Tray Specifications	
<b>Material</b>	Antistatic PET
<b>Surface resistance</b>	$10^6 < \text{Ohm/square} < 10^{12}$
<b>Tray capacity</b>	35 products/tray
<b>Tray thickness</b>	13 mm [0.512 inch]
<b>Box capacity</b>	175 products ( 5 full trays/box)
<b>Bakability</b>	The tray is not bakable.

Carrier Tape Specifications	
<b>Material</b>	Antistatic PS
<b>Surface resistance</b>	$10^7 < \text{Ohm/square} < 10^{12}$
<b>Bakability</b>	The tape is not bakable.
<b>Tape width</b>	56 mm [2.205 inch]
<b>Pocket pitch</b>	24 mm [0.945 inch]
<b>Pocket depth</b>	9.57 mm [0.377 inch]
<b>Reel diameter</b>	381 mm [15 inch]
<b>Reel capacity</b>	250 products /reel

**Non-Dry Pack Information**

The through hole mount version of product is delivered in non-dry packing trays. The lead (Pb) surface mount version of product is delivered in non-dry packing trays or tape & reel.

**Dry Pack Information**

The lead free (Pb-free) surface mount version of the product is delivered in trays or tape & reel. These inner shipment containers are dry packed in standard moisture barrier bags according to IPC/JEDEC standard J-STD-033 (Handling, packing, shipping and use of moisture/reflow sensitivity surface mount devices).

Using products in high temperature Pb-free soldering processes requires dry pack storage and handling. In case the products have been stored in an uncontrolled environment and no longer can be considered dry, the modules must be baked according to J-STD-033.

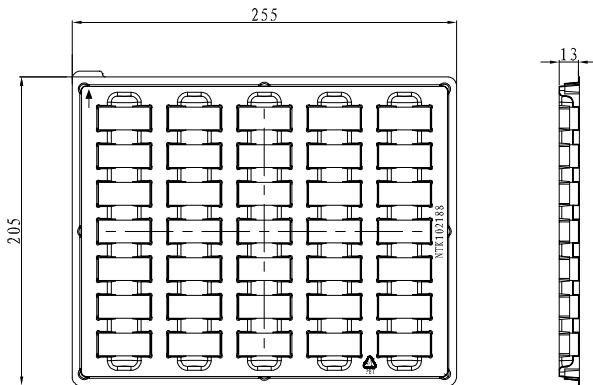

PMN 5000 series DC/DC regulator, Input 4.5-5.5 V, Output 30 A/108 W	EN/LZT 146 386 R1B Oct 2011
	© Ericsson Power Modules AB

**Product Qualification Specification**

Characteristics			
External visual inspection	IPC-A-610		
Change of temperature (Temperature cycling)	IEC 60068-2-14 Na	Temperature range Number of cycles Dwell/transfer time	-40 to +100 °C 1000 15 min/0-1 min
Cold (in operation)	IEC 60068-2-1 Ad	Temperature T <sub>A</sub> Duration	-45°C 72 h
Damp heat	IEC 60068-2-67 Cy	Temperature Humidity Duration	+85 °C 85 % RH 1000 hours
Dry heat	IEC 60068-2-2 Bd	Temperature Duration	+125 °C 1000 h
Immersion in cleaning solvents	IEC 60068-2-45 XA Method 2	Water Glycol ether	+55° C +35° C
Mechanical shock	IEC 60068-2-27 Ea	Peak acceleration Duration	100 g 6 ms
Moisture reflow sensitivity <sup>1</sup>	J-STD-020C	level 1 (SnPb-eutectic) level 3 (Pb Free)	225° C 260° C
Operational life test	MIL-STD-202G method 108A	Duration	1000 h
Resistance to soldering heat <sup>2</sup>	IEC 60068-2-20 Tb Method 1A	Solder temperature Duration	270° C 10-13 s
Robustness of terminations	IEC 60068-2-21 Test Ua1 IEC 60068-2-21 Test Ue1	Through hole mount products Surface mount products	All leads All leads
Solderability	IEC 60068-2-58 test Td <sup>1</sup>	Preconditioning Temperature, SnPb Eutectic Temperature, Pb-free	150 °C dry bake 16 h 215° C 235° C
	IEC 60068-2-20 test Ta <sup>2</sup>	Preconditioning Temperature, SnPb Eutectic Temperature, Pb-free	Steam ageing 235 ° C 245 ° C
Vibration, broad band random	IEC 60068-2-64 Fh, method 1	Frequency Spectral density Duration	10 to 500 Hz 0.07 g <sup>2</sup> /Hz 10 min in each perpendicular direction

Note 1: Only for products intended for reflow soldering (surface mount products)

Note 2: Only for products intended for wave soldering (plated through hole products)