

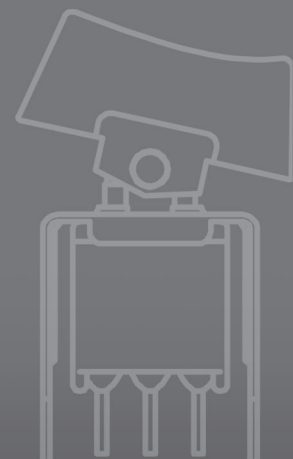

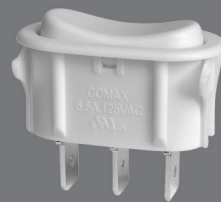





audio
automotive
aerospace
communication devices
consumer appliances
consumer electronics
datacom
data storage
handheld devices
industrial
industrial equipment
instrumentation
medical
military
mobile phones
portable tools
pumps & motors
security alarms
telecom
test equipment
thermostatic controls









rocker

Rockers

Product Selection Guide



Rocker							
Series	7000	E	ET	T	9000	DA	D
Switch Type	Miniature	Miniature	Subminiature	Subminiature	Power Rocker & Lever Handle	Miniature Power	Miniature Power
Poles/Throws	SPDT, DPDT, 3PDT, 4PDT	SPDT, DPDT, 3PDT	SPST, SPDT, DPDT	SPST, SPDT, DPDT	DPDT	SPST, SPDT	SPST, SPDT, DPST, DPDT
Max. Current	5 Amps	7.5 Amps	3 Amps	3 Amps	10 Amps	16 Amps 10 Amps	4 Amps 10 Amps
Washable		•	•				
Illuminated						•	
Panel Mount Options							
Front Mount	•	•		•	•	Snap-in	Snap-in
Rear Mount	•	•		•	•		
PCB Mount Options							
Vertical	•	•	•	•	•	•	•
Right Angle	•	•	•	•	•	•	•
Surface Mount			•				
Page No.	G-4	G-26	G-40	G-46	G-52	G-57	G-61

Rocker							
Series	DM	DM	DF	CR	SW	CG	CL
Switch Type	Miniature 2 Pole Power	Miniature Illuminated Power	Power	Round	Miniature Power	Power	Power
Poles/Throws	DPST, DPDT	SPST, DPST	SPST, SPDT, DPST	SPST, SPDT	SPST, SPDT, DPST	SPST, SPDT	SPST, SPDT
Max. Current	3 Amps, 10 Amps	3 Amps, 10 Amps	16 Amps	10 Amps, 6 Amps	3 A, 6 A, 6.5 A, 10 A, 16 A	10 Amps 16 Amps	10 Amps 16 Amps
Washable							
Illuminated		•		•	•	•	•
Panel Mount Options							
Front Mount	Snap-in	Snap-in	Snap-in	Snap-in	Snap-in	Snap-in	Snap-in
Rear Mount			•				
PCB Mount Options							
Vertical							
Right Angle			•				
Surface Mount							
Page No.	G-66	G-70	G-74	G-78	G-82	G-83	G-87



Rockers

Product Selection Guide

Rocker		
Series	CM	CN
Switch Type	Power	Power
Poles/Throws	SPDT, DPDT	DPST, DPDT
Max. Current	10 Amps 16 Amps	10 Amps 16 Amps
Washable		
Illuminated	•	•
Panel Mount Options		
Front Mount	Snap-in	Snap-in
Rear Mount		
PCB Mount Options		
Vertical		
Right Angle		
Surface Mount		
Page No.	G-91	G-95

7000 Series Miniature Rocker & Lever Handle Switches

Features/Benefits

- Multi-pole and multi-position
- Wide variety of actuator and termination options
- Epoxy terminal-seal compatible with bottom wash cleaning
- RoHS compliant

Typical Applications

- Telecommunications
- Instrumentation
- Medical equipment

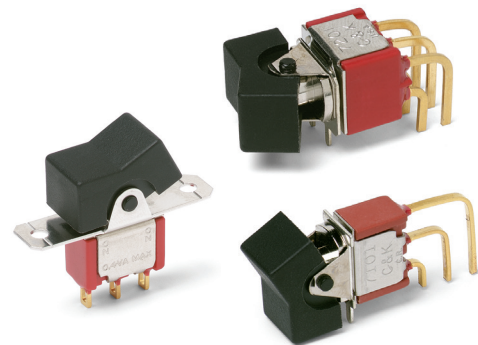

Specifications

CONTACT RATING: B contact material: 0.4 VA max. @ 20 V AC or DC max. Q contact material: 5 AMPS @ 120 V AC or 28 V DC; 2 AMPS @ 250 V AC. See page G-20 for additional ratings.

ELECTRICAL LIFE: 7X01 and UX1 models: 100,000 make-and-break cycles at full load. All other models: 40,000 cycles.

CONTACT RESISTANCE: Below 10 mΩ typ. initial @ 2-4 V DC, 100 mA, for both silver and gold plated contacts.

INSULATION RESISTANCE: 10⁹ Ω min.

DIELECTRIC STRENGTH: 1000 Vrms min. @ sea level.

OPERATING TEMPERATURE: -30°C to 85°C.

SOLDERABILITY: Per MIL-STD-202F method 208D, or EIA RS-186E method 9 (1 hour steam aging).

NOTE: Any models supplied with S, P, R, Q, B or G contact material are RoHS compliant.

NOTE: Specifications and materials listed above are for switches with standard options. For information on specific and custom switches, consult Customer Service Center.

Materials

CASE: Glass filled nylon 6/6, flame retardant, heat stabilized, or diallyl phthalate (DAP) (UL 94V-0).

ACTUATOR: Nylon, black.

FRAME (FRONT MOUNT): Nylon, black.

FRAME (REAR MOUNT): Spring steel, black.

BUSHING: Brass or zinc, nickel plated.

HOUSING: Stainless steel.

SWITCH SUPPORT: Brass or steel, matte-tin plated.

END CONTACTS: B contact material: Copper alloy, with gold plate over nickel plate. Q contact material: Coin silver, silver plated. See page G-20 for additional contact materials.

CENTER CONTACTS & ALL TERMINALS: B contact material: Copper alloy, with gold plate over nickel plate. Q contact material: Copper alloy, silver plated. See page G-20 for additional contact materials.

TERMINAL SEAL: Epoxy. Refer to Soldering and Cleaning in Technical Data Section

HARDWARE: Mounting nuts & screws: Brass. Lockwasher: Stainless steel. Standoff: Nylon standard.

Build-A-Switch

To order, simply select desired option from each category and place in the appropriate box. Available options are shown and described on pages G-4 through G-24. For additional options not shown in catalog, consult Customer Service Center. All models have epoxy terminal seal and are compatible with all "bottom-wash" PCB cleaning methods.

Switch Function

- 7101 SP On-None-On
- 7103 SP On-Off-On
- 7105 SP Mom.-Off-Mom.
- 7107 SP On-Off-Mom.
- 7108 SP On-None-Mom.
- 7109 SP None-On-Mom.
- 7201 DP On-None-On
- 7203 DP On-Off-On
- 7205 DP Mom.-Off-Mom.
- 7207 DP On-Off-Mom.
- 7208 DP On-None-Mom.
- 7211 DP On-On-On
- 7213 DP On-On-Mom.
- 7215 DP Mom.-On-Mom.
- 7301 3P On-None-On
- 7303 3P On-Off-On
- 7401 4P On-None-On
- 7405 4P Mom.-Off-Mom.
- 7411 4P On-On-On

Note: UL models available, see pages G-5 and G-6.

Actuator

- J1 .531" long rocker
- J2 Lever
- J3 .906" long rocker
- J10 1.318" long rocker
- J11 Rocker with frame
- J15 Rocker, snap-in
- J16 Rocker with frame, snap-in
- J19 Rocker with frame
- J21 Lever with frame
- J25 Lever, snap-in
- J26 Lever with frame, snap-in
- J37 Rocker with frame
- J50 Rocker
- J51 Rocker with frame
- J52 Rocker with frame for LED, snap-in
- J60 Lever
- J61 Lever with frame, snap-in
- J62 Lever with frame for LED, snap-in
- J90 Lever
- J91 Lever with frame, snap-in

Terminations

- A Right angle, PC thru-hole
- AV2 Vertical right angle, PC thru-hole
- C PC Thru-hole
- Z Solder lug
- A3 Right angle, snap-in, PC thru-hole
- AV3 Vertical right angle, snap-in, PC thru-hole
- AW3 Right angle, extended, PC thru-hole
- V2 .555" high, V-bracket
- V3 .460" high, V-bracket
- V4 .630" high, V-bracket
- V5 Vertical right angle, PC thru-hole
- V6 .460" high, V-bracket
- V7 .630" high, V-bracket
- V8 .953" high, V-bracket
- V9 1.150" high, V-bracket
- V31 .460" high, V-bracket, snap-in
- V51 Vertical right angle, snap-in
- V61 .460" high, V-bracket, snap-in
- W .750" long, wire wrap
- W3 .425" long, wire wrap
- W5 1.305" long, wire wrap
- Z3 Quick connect

Contact Material

- B Gold
- P Gold, matte tin
- Q Silver
- S Silver, matte-tin
- G Gold over silver
- R Gold over silver, matte-tin

Seal

- E Epoxy
- I Epoxy potted base

Actuator Color

- 2 Black
- 1 White
- 3 Red

Frame Color

- 2 Black
- NONE No frame color required
- 1 White

Metal Frame Color

- (J11, J19, J21 & J37 Actuators)
- 2 Black
 - 1 White

Rocker

G



27 mar 17

7000 Series Miniature Rocker & Lever Handle Switches

SWITCH FUNCTION

NO. POLES	MODEL NO.	UL** MODEL NO.	SWITCH FUNCTION			CONNECTED TERMINALS			SCHEMATIC
			POS. 1	POS. 2	POS. 3	POS. 1	POS. 2	POS. 3	
SP	7101	U11	ON	NONE	ON	2-3	N/A	2-1	
	7103	U13	ON	OFF	ON		OPEN		
	7105	U15	MOM.	OFF	MOM.				
	7107	U17	ON	OFF	MOM.	N/A			
	7108	U18	ON	NONE	MOM.				
	7109	U19	NONE	ON	MOM.	N/A	2-3	2-1	

SPDT

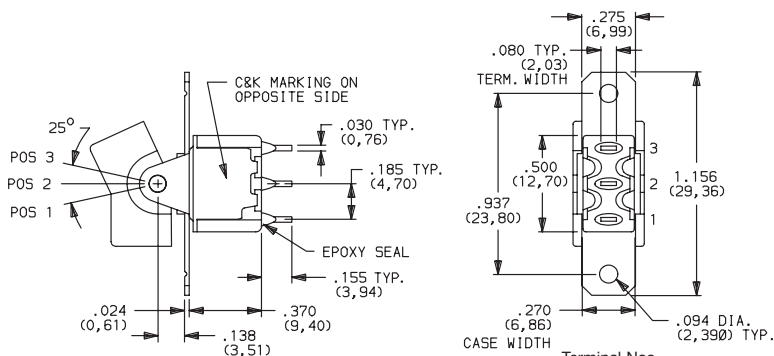

Part number shown: 7101J1ZQE2

Terminal Nos.
For Reference Only

DP	7201	U21	ON	NONE	ON	2-3-5-6	N/A	2-1,5-4	
	7203	U23	ON	OFF	ON		OPEN		
	7205	U25	MOM.	OFF	MOM.				
	7207	U27	ON	OFF	MOM.	N/A			
	7208	U28	ON	NONE	MOM.				
	7211*	U211*	ON	ON	ON	2-3-5-4			
	7213*	U213*	ON	ON	MOM.				
7215*	U215*	MOM.	ON	MOM.			DPDT		

DPDT

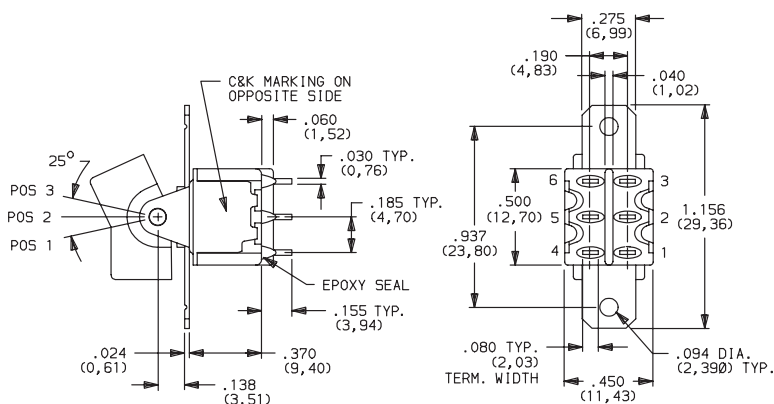

Part number shown: 7201J1ZQE2

Terminal Nos.
For Reference Only

MOM. = Momentary

* Wiring for 3-way switch, see Section N.

** U11 through U413 model nos. with all options when ordered with G, Q, R or S contact material.

7000 Series Miniature Rocker & Lever Handle Switches

SWITCH FUNCTION

NO. POLES	MODEL NO.	UL** MODEL NO.	SWITCH FUNCTION			CONNECTED TERMINALS			SCHEMATIC
			POS. 1	POS. 2	POS. 3	POS. 1	POS. 2	POS. 3	
3P	7301	U31	ON	NONE	ON	2-3,5-6,8-9	N/A	2-1,5-4,8-7	 3PDT
	7303	U33	ON	OFF	ON		OPEN		

3PDT

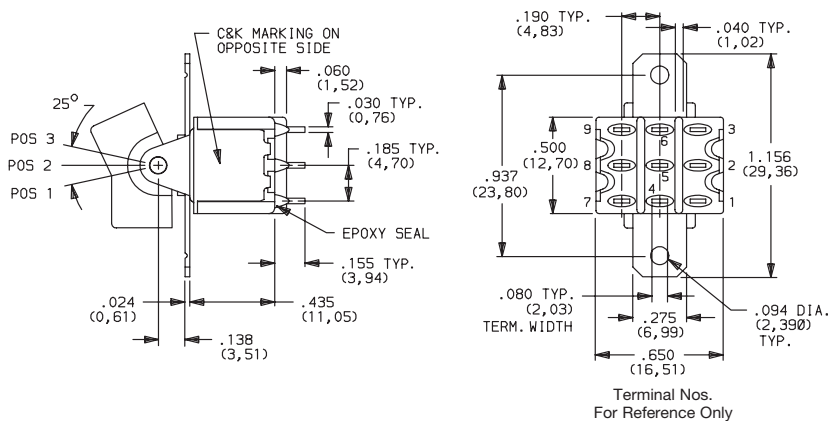

Part number shown: 7301J1ZQE2

4P	7401	U41	ON	NONE	ON	2-3,5-6,8-9,11-12	N/A	2-1,5-4,8-7,11-10	 4PDT
	7405	U45	MOM.	OFF	MOM.		OPEN		
	7411*	U411*	ON	ON	ON		2-3,5-4,8-9,11-10		

4PDT

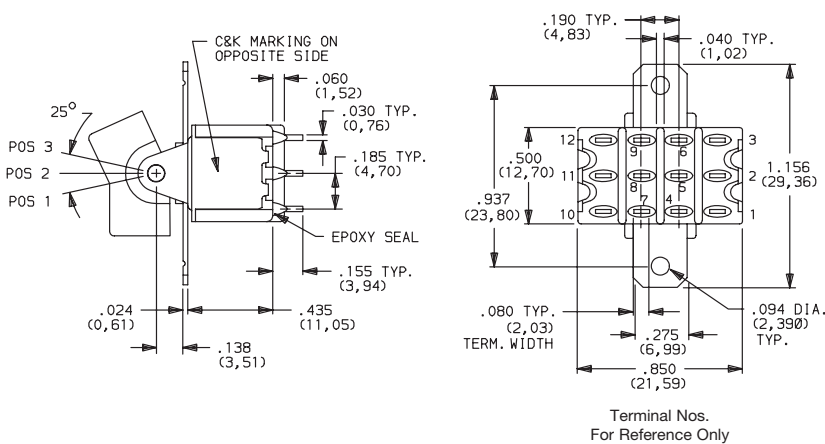

Part number shown: 7401J1ZQE2

MOM. = Momentary

** U11 through U411 model nos. with all options when ordered with G, Q, R or S contact material.

* Wiring for 3-way switch: See Technical Data section of this catalog for RoHS compliant and compatible definitions and specifications.

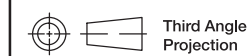

Third Angle Projection
Dimensions are shown: Inches (mm)
Specifications and dimensions subject to change



27 mar 17

7000 Series Miniature Rocker & Lever Handle Switches

ACTUATOR-PANEL REAR MOUNT

ACTUATOR COLOR

ACTUATOR

J1 ROCKER

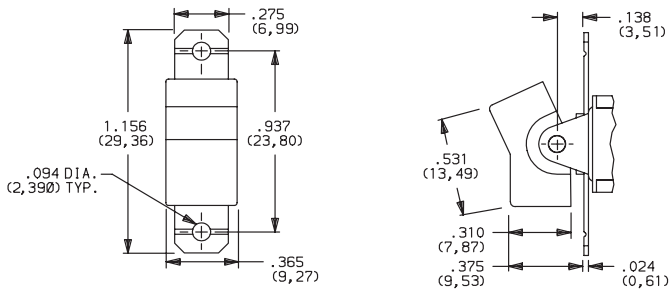

J2 LEVER

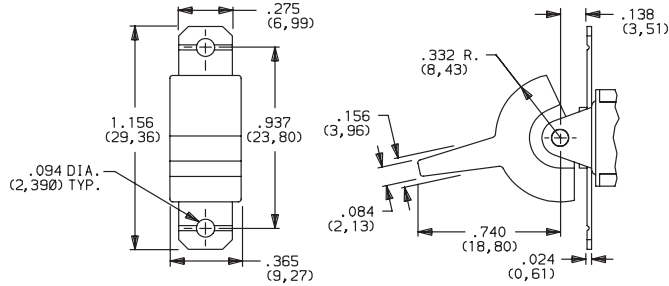

J3 ROCKER

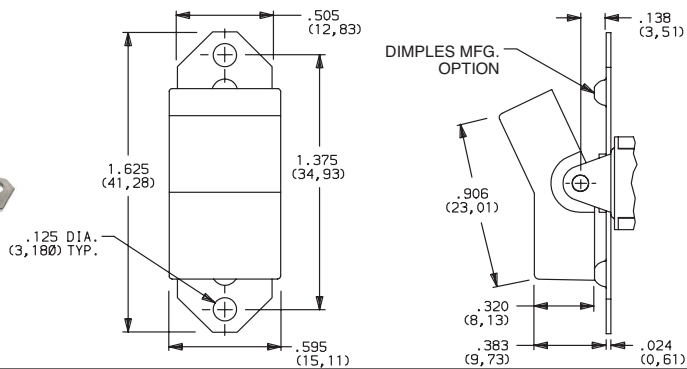

J10 ROCKER

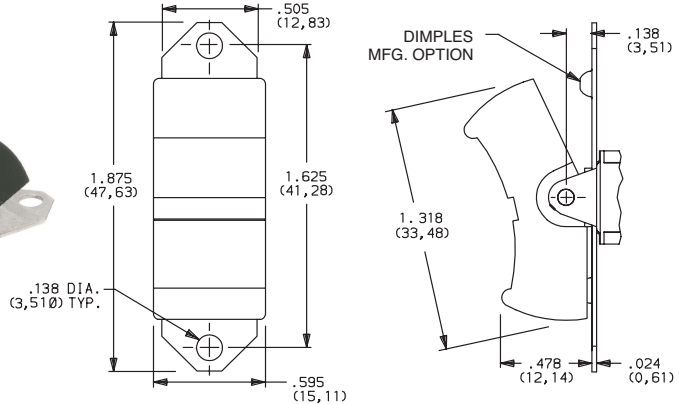

OPTION CODE	ACTUATOR COLOR
2	BLACK
1	WHITE
3	RED

Finish: Matte. Other colors, custom actuator markings and legends available, consult Customer Service Center.

NOTE: Hardware: two each—mounting screws, nuts, lockwashers and standoffs for 1/8 inch thick panel are supplied standard on all switches with panel mounting brackets. Actuators available separately, see page G-21 through G-22. Hardware is available see Technical Data section of this catalog.

J1, J2, J3 & J10 Actuators available with C, W-W5, Z or Z3 terminations.

PANEL MOUNTING

J1 & J2 Actuators

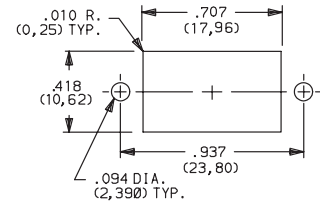

J3 Actuator

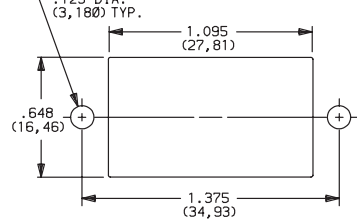

J10 Actuator

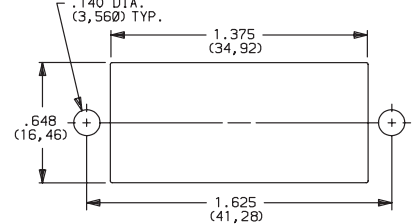

Third Angle Projection

Dimensions are shown: Inches (mm)
Specifications and dimensions subject to change



7000 Series Miniature Rocker & Lever Handle Switches

ACTUATOR-SNAP-IN FRONT MOUNT

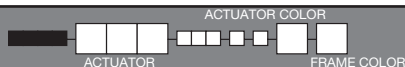

OPTION CODE	ACTUATOR COLOR
2	BLACK
1	WHITE
3	RED

OPTION CODE	FRAME COLOR
2	BLACK
NONE	No Frame Color (J15 or J25 options)
1	WHITE

Finish: Matte. Other colors, custom actuator markings and legends available, consult Customer Service Center.

NOTE: Actuators & frames available separately, see pages G-21 through G-22. J15, J16, J25, J26, J50 & J51 Actuators available with 71XX, 72XX, U1XX & U2XX models and C, W-W5, Z and Z3 terminations.

PANEL MOUNTING

J15, J16, J25 & J26 Actuators

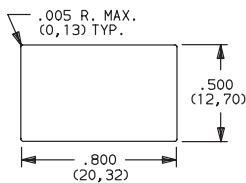

J50 Actuator

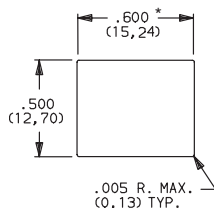

* For J50: Increase this dimension to .620/.625 (15,75/15,88) for .091/.125 (2,31/3,18) thk. panels.

J15 ROCKER, SNAP-IN

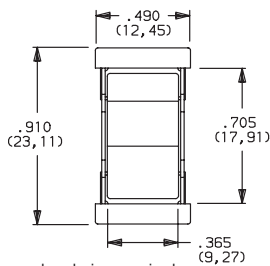

No frame color choice required

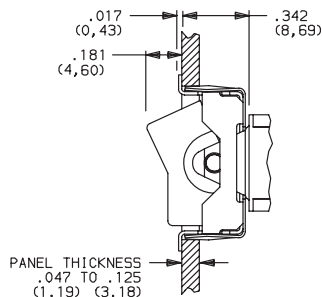

J16 ROCKER WITH FRAME, SNAP-IN

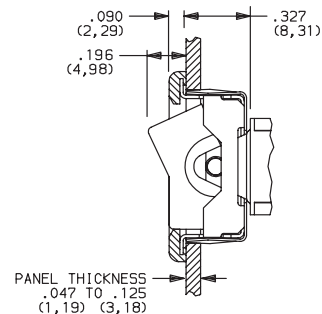
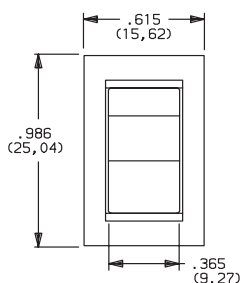

J25 LEVER, SNAP-IN

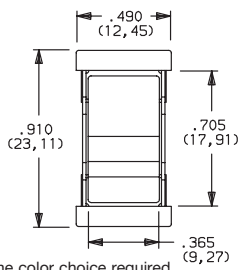

No frame color choice required

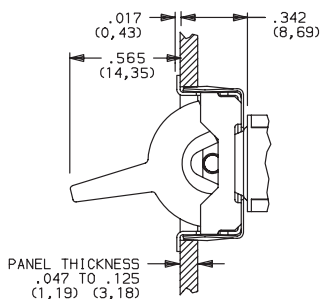

J26 LEVER WITH FRAME, SNAP-IN

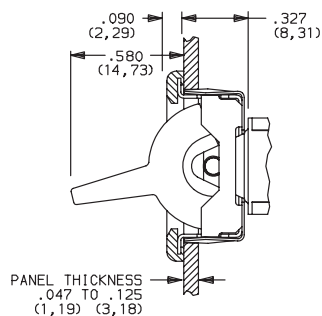
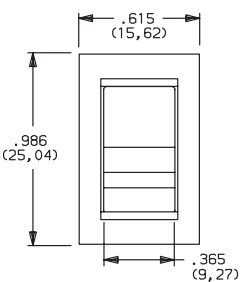

J50 ROCKER, SNAP-IN

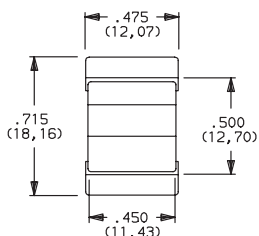

No frame color choice required

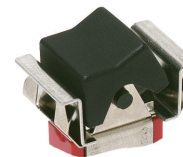
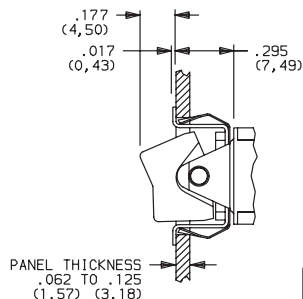

Dimensions are shown: Inches (mm)
Specifications and dimensions subject to change

7000 Series Miniature Rocker & Lever Handle Switches

ACTUATOR-SNAP-IN FRONT MOUNT



J51 ROCKER WITH FRAME, SNAP-IN

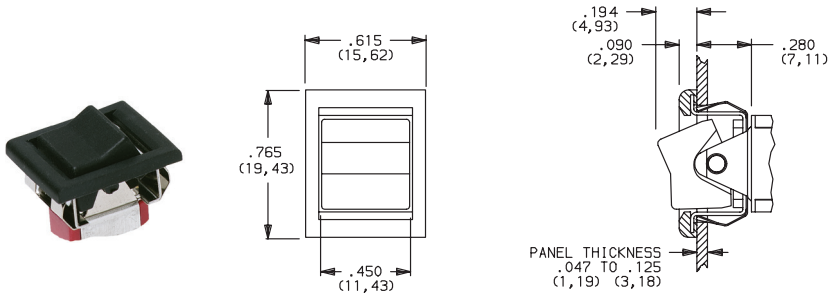

OPTION CODE	ACTUATOR COLOR
2	BLACK
1	WHITE
3	RED

J52 ROCKER WITH FRAME FOR LED, SNAP-IN

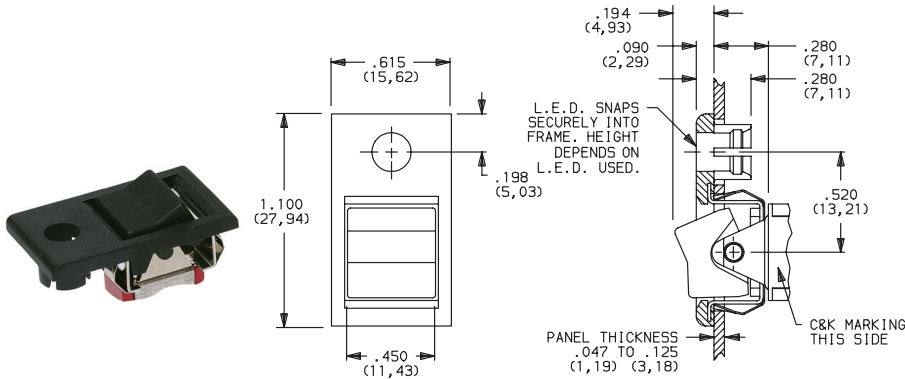

OPTION CODE	FRAME COLOR
2	BLACK
NONE	No Frame Color (J15 or J25 options)
1	WHITE

Finish: Matte. Other colors, custom actuator markings and legends available, consult Customer Service Center.

NOTE: Actuators & frames available separately, see pages G-21 through G-22. J51, J52, J60 & J61 Actuators available with 71XX, 72XX, U1XX & U2XX models and C, W-W5, Z and Z3 terminations.

LED not included.
For LED information, see page G-24.

J60 LEVER, SNAP-IN

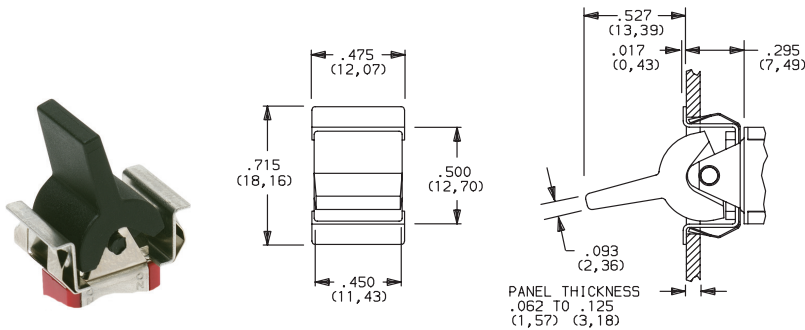

No frame color choice required

PANEL MOUNTING

J51, J60 & J61 Actuators

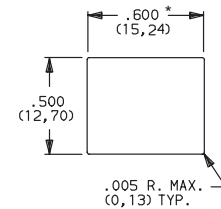

J52 Actuator

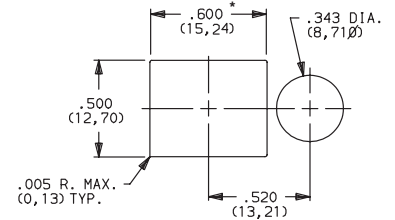

For J51, J52: Increase this dimension to .620/.625 (15,75/15,88) for .060/.125(1,52/3,18) thk. panels.

J61 LEVER WITH FRAME, SNAP-IN

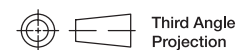
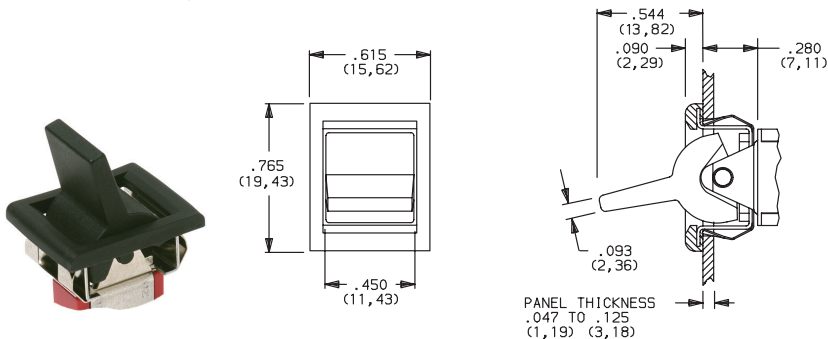

Dimensions are shown: Inches (mm)
Specifications and dimensions subject to change



7000 Series Miniature Rocker & Lever Handle Switches

ACTUATOR-SNAP-IN FRONT MOUNT

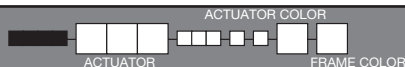

OPTION CODE	ACTUATOR COLOR
2	BLACK
1	WHITE
3	RED

OPTION CODE	FRAME COLOR
2	BLACK
NONE	No Frame Color (J90 options)
1	WHITE

Finish: Matte. Other colors, custom actuator markings and legends available, consult Customer Service Center.

NOTE: Actuators & frames available separately, see pages G-21 through G-22. J62, J90 & J91 Actuators available with 71XX, 72XX, U1XX & U2XX models and C, W-W5, Z & Z3 terminations.

PANEL MOUNTING

J62 Actuator

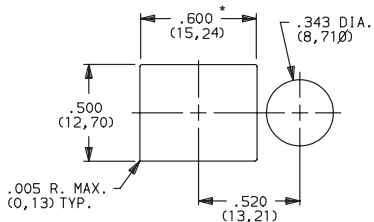

J90, J91 & J93 Actuators

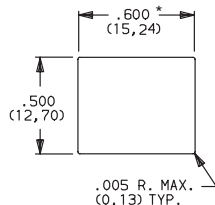

* For J90: Increase this dimension to .620/.625 (15,75/15,88) for .091/.125 (2,31/3,18) thk. panels.
For J91: Increase this dimension to .620/.625 (15,75/15,88) for .060/.125 (1,52/3,18) thk. panels.

J62 LEVER WITH FRAME FOR LED, SNAP-IN

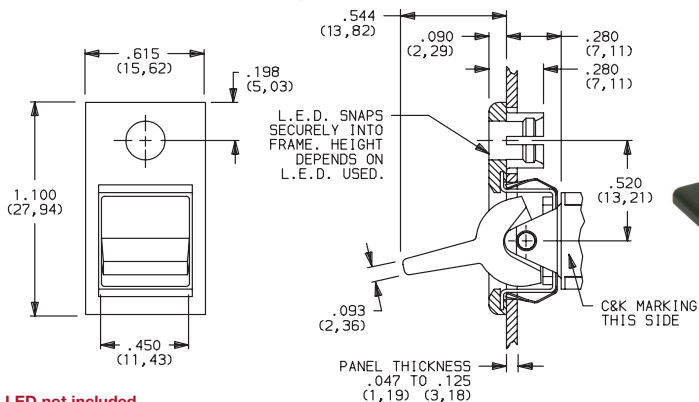

LED not included.
For LED information, see page H-25.



J90 LEVER, SNAP-IN

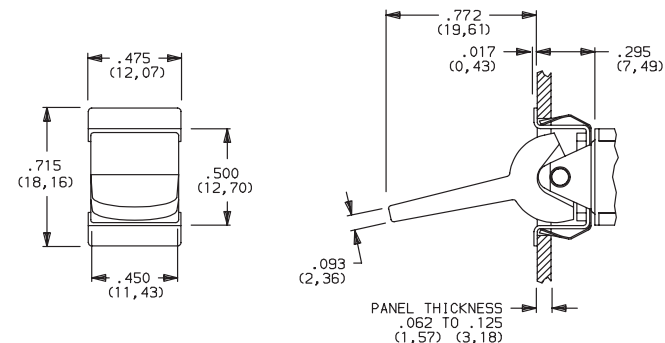

No frame color choice required.



J91 LEVER WITH FRAME, SNAP-IN

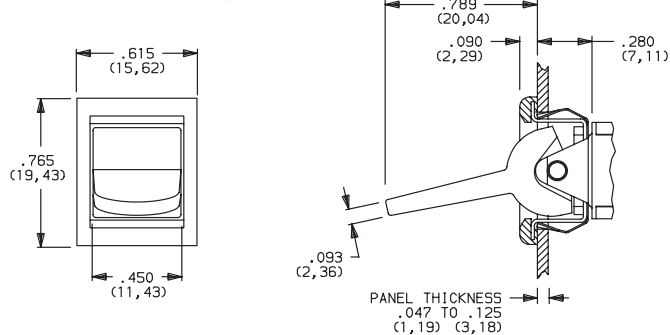

Dimensions are shown: Inches (mm)

Specifications and dimensions subject to change

7000 Series Miniature Rocker & Lever Handle Switches

ACTUATOR-REAR MOUNT

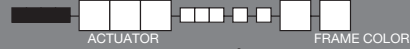

J11 ROCKER WITH FRAME

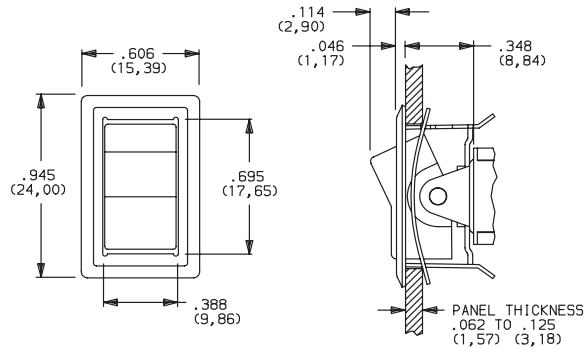

OPTION CODE	ACTUATOR COLOR
2	BLACK
1	WHITE
3	RED

OPTION CODE	FRAME COLOR
2	BLACK
1	WHITE

Actuator finish: Matte. Frame finish: Gloss. Other colors, custom actuator markings and legends available, consult Customer Service Center.

NOTE: Actuators & frames available separately, see pages G-21 through G-22. J11, J19, J21 & J37 Actuators available with C, W-W5, Z & Z3 terminations. J37 offered with Black Frame (2 color option) only.

J19 ROCKER WITH FRAME

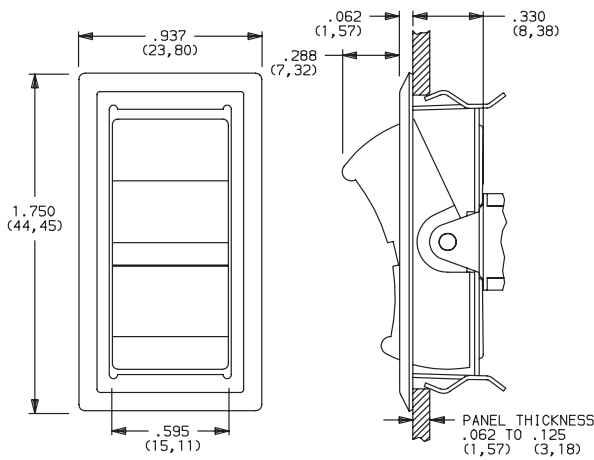

PANEL MOUNTING

J11 & J21 Actuators

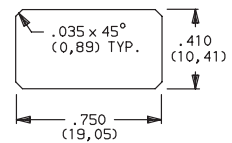

J19 Actuator

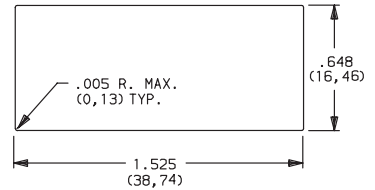

J37 Actuator

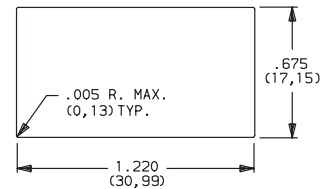

J21 LEVER WITH FRAME

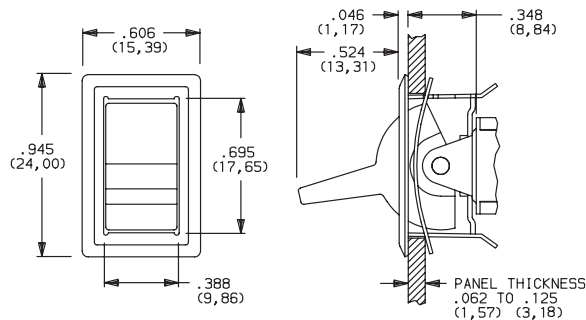

J37 ROCKER WITH FRAME

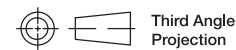
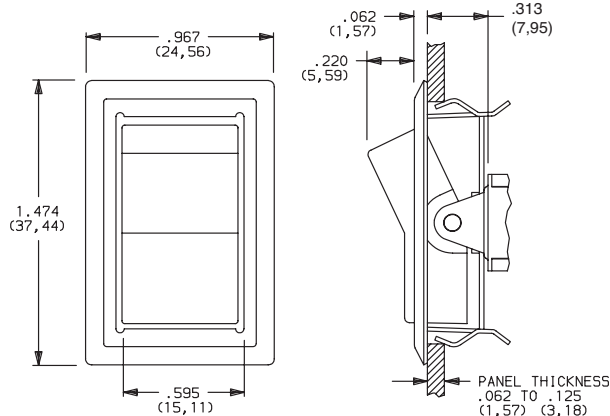

Dimensions are shown: Inches (mm)
 Specifications and dimensions subject to change



7000 Series Miniature Rocker & Lever Handle Switches

ACTUATOR-PC MOUNT

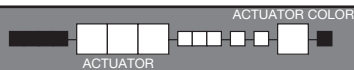

OPTION CODE	ACTUATOR COLOR
2	BLACK
1	WHITE
3	RED

Finish: Matte. Other colors, custom actuator markings and legends available, consult Customer Service Center.

NOTE: Some permissible actuator/termination combinations may lack clearance between actuator and PC board, and care must be exercised to accommodate this condition.

Actuators available separately, see page G-21 through G-22. J1, J2 actuators available with A, A3, AV2, AV3, AW3 & V2 terminations. J3 actuators available with AV2, AV3 & V2-V61 terminations. J50 actuators available with A (DP, 3P models only), A3 (DP, 3P models only), AV2, AV3, AW3 (DP, 3P models only) & V2-V61 terminations.

J1 ROCKER

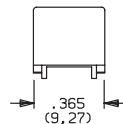
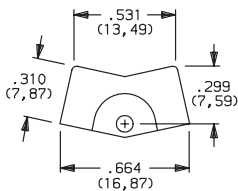

J2 LEVER

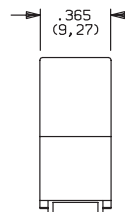
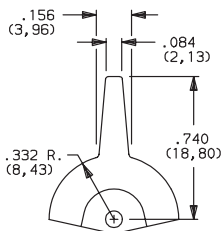

J3 ROCKER

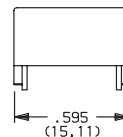
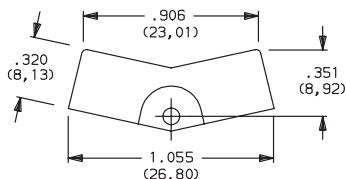

J50 ROCKER

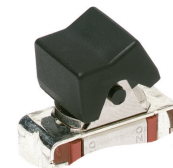
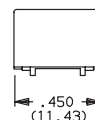
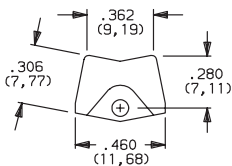

Rocker



Dimensions are shown: Inches (mm)
Specifications and dimensions subject to change

7000 Series Miniature Rocker & Lever Handle Switches

ACTUATOR-PC MOUNT

ACTUATOR COLOR

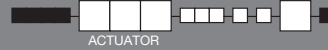

J60 LEVER

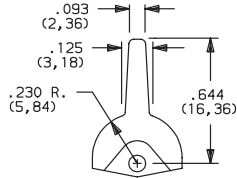

OPTION CODE	ACTUATOR COLOR
2	BLACK
1	WHITE
3	RED

Finish: Matte. Other colors, custom actuator markings and legends available, consult Customer Service Center.

NOTE: Some permissible actuator/termination combinations may lack clearance between actuator and PC board, and care must be exercised to accommodate this condition.

J90 LEVER

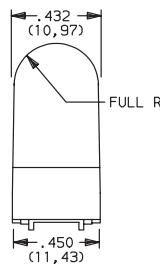
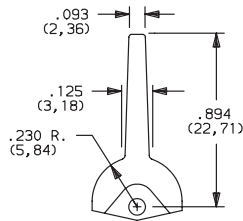

Actuators available separately, see page G-21 through G-22. J60 & J90 actuators available with A (DP, 3P models only), A3 (DP, 3P models only), AV2, AV3, AW3 (DP, 3P models only) & V2-V61 terminations.

TERMINATIONS

Z SOLDER LUG

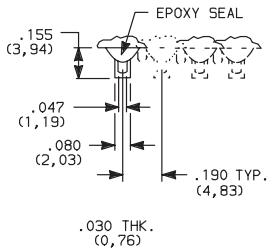

SPDT thru 4PDT

Not available with P, R or S contact materials. Available actuators, see pages G-7 through G-13.

C PC THRU-HOLE

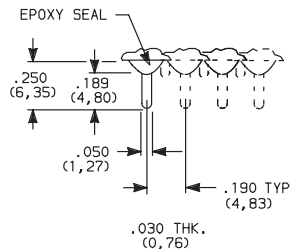

SPDT thru 4PDT

NOTE: Available actuators, see pages G-7 through G-13.

PC MOUNTING

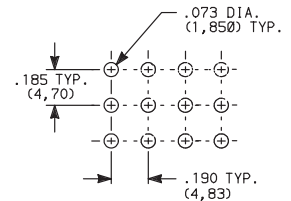

Z3 QUICK CONNECT

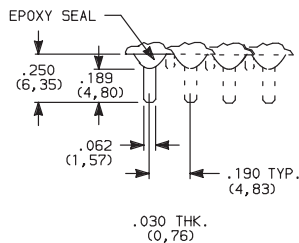

SPDT thru 4PDT

Not available with P, R or S contact materials. Available actuators, see pages G-7 through G-13. Mating quick connector available; order part number 530100000, page G-22.

W, W3, W5 WIRE WRAP

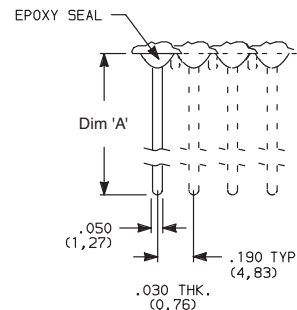

SPDT thru 4PDT

NOTE: Available actuators, see pages G-7 through G-13.

OPTION CODE	DIM 'A'
W	.750 (19,05)
W3	.425 (10,80)
W5	1.305 (33,15)

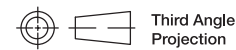

Third Angle Projection

Dimensions are shown: Inches (mm)
Specifications and dimensions subject to change

7000 Series Miniature Rocker & Lever Handle Switches

TERMINATIONS

A RIGHT ANGLE, PC THRU-HOLE

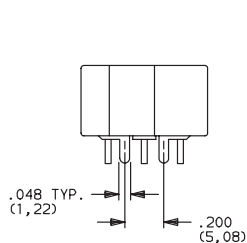

Actuator Shown In Pos. 1

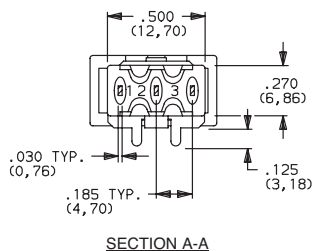
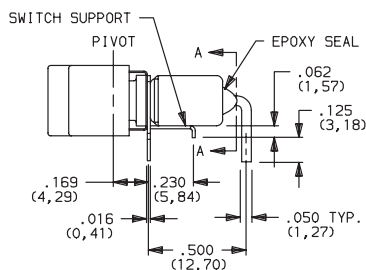

7101J1ABE2
Horizontal Actuation
SPDT

A3 RIGHT ANGLE, SNAP-IN, PC THRU-HOLE

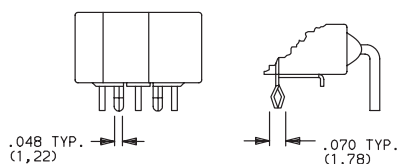

AW3 RIGHT ANGLE, EXTENDED, PC THRU-HOLE

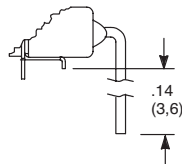

PC MOUNTING

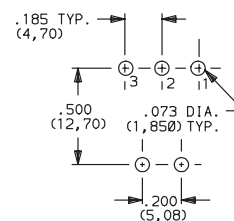

Not available with I seal option. Available actuators, see pages G-6 and G-12.
Terminal bend radii and lead-in manufacturing option.

NOTE: PC pattern must clear switch support leg.

A RIGHT ANGLE, PC THRU-HOLE

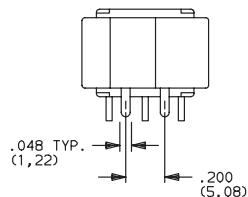

Actuator Shown In Pos. 1

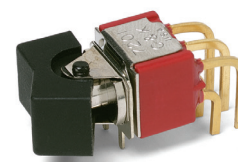
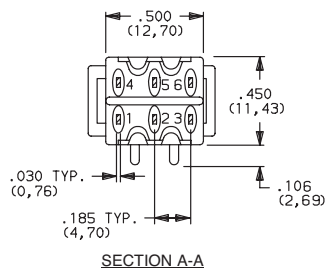
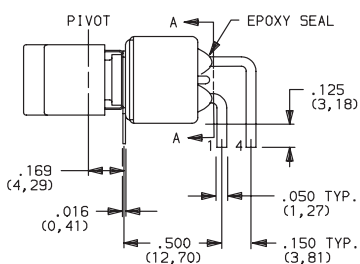

7201J1ABE2
Horizontal Actuation
DPDT

A3 RIGHT ANGLE, SNAP-IN, PC THRU-HOLE

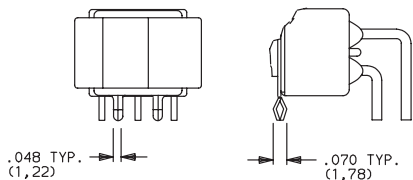

PC MOUNTING

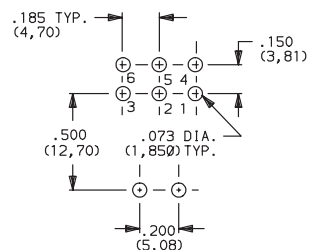

Not available with I seal option. Available actuators, see pages G-6 and G-12.
Terminal bend radii and lead-in manufacturing option.

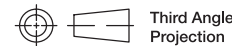

Dimensions are shown: Inches (mm)

Specifications and dimensions subject to change

Rocker

G

C&K

27 mar 17

7000 Series Miniature Rocker & Lever Handle Switches

TERMINATIONS

A RIGHT ANGLE, PC THRU-HOLE

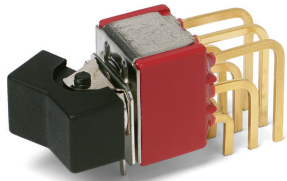

7301J1ABE2
Horizontal Actuation
3PDT

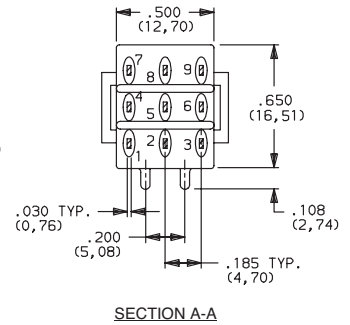
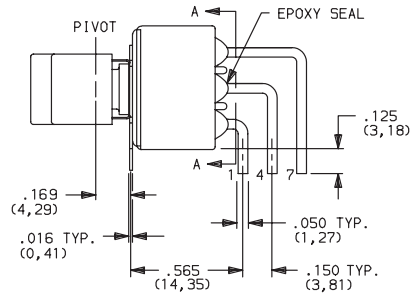
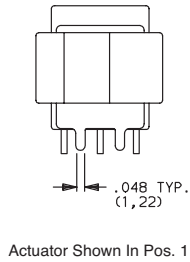

Not available with I seal option. Available actuators, see pages G-6 and G-12.
Terminal bend radii and lead-in manufacturing option.

PC MOUNTING

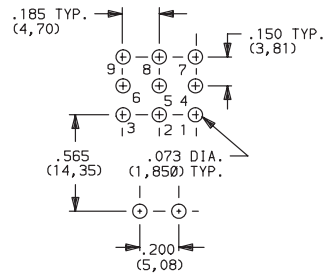

AV2 VERTICAL RIGHT ANGLE, PC THRU-HOLE, .150" PITCH

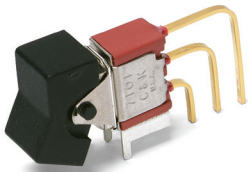

7101J1AV2BE2
Vertical Actuation
SPDT

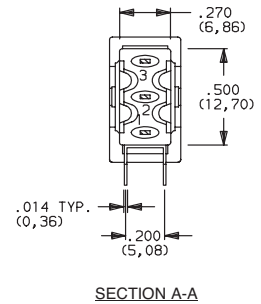
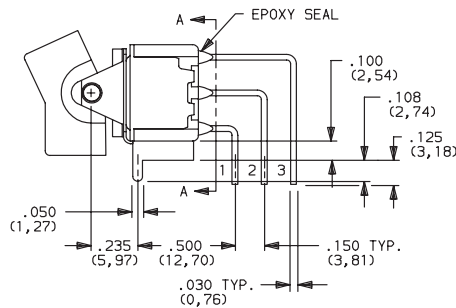
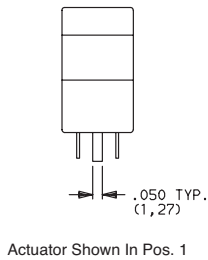

AV3 VERTICAL RIGHT ANGLE, SNAP-IN, PC THRU-HOLE, .150" PITCH

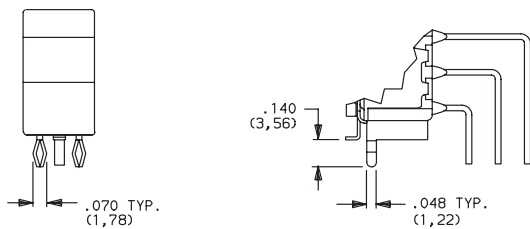

Not available with I seal option. Available actuators, see pages G-6 and G-12.
Terminal bend radii and lead-in manufacturing option.

PC MOUNTING

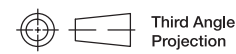
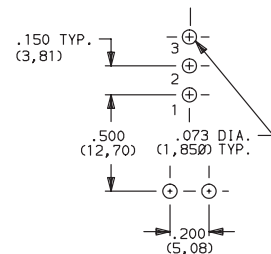

Dimensions are shown: Inches (mm)
Specifications and dimensions subject to change



7000 Series Miniature Rocker & Lever Handle Switches

TERMINATIONS

AV2 VERTICAL RIGHT ANGLE, PC THRU-HOLE,
.150" PITCH

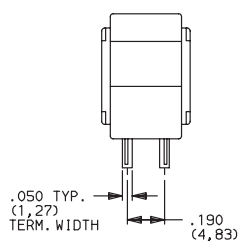

Actuator Shown In Pos. 1

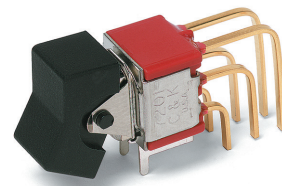
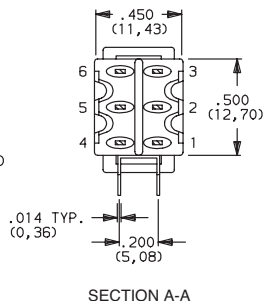
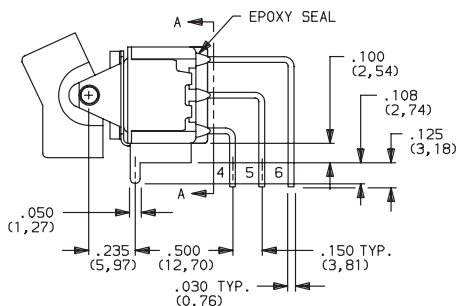

7201J1AV2BE2
Vertical Actuation
DPDT

AV3 VERTICAL RIGHT ANGLE, SNAP-IN, PC THRU-HOLE,
.150" PITCH

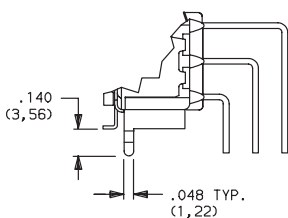
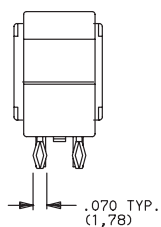

PC MOUNTING

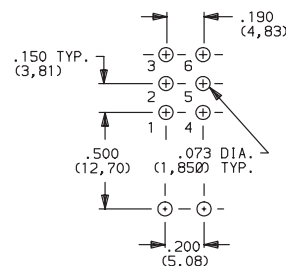

Not available with I seal option. Available actuators, see pages G-6 and G-12.
Terminal bend radii and lead-in manufacturing option.

AV2 VERTICAL RIGHT ANGLE, PC THRU-HOLE,
.150" PITCH

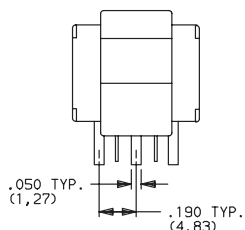

Actuator Shown In Pos. 1

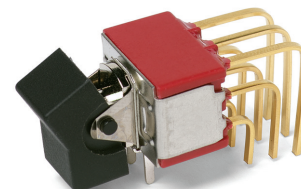
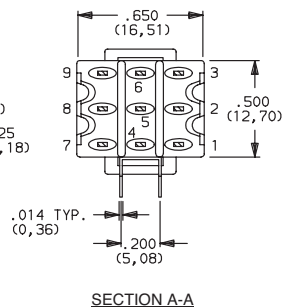
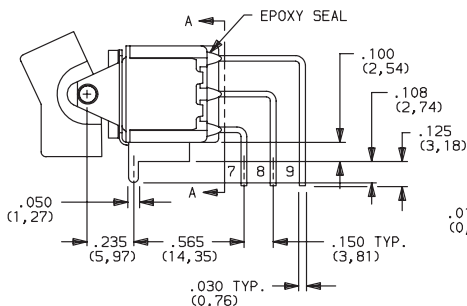

7301J1AV2BE2
Vertical Actuation
3PDT

AV3 VERTICAL RIGHT ANGLE, SNAP-IN, PC THRU-HOLE,
.150" PITCH

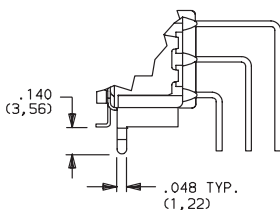
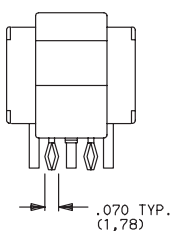

PC MOUNTING

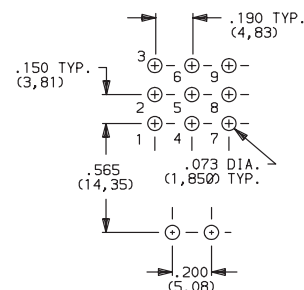

Not available with I seal option. Available actuators, see pages G-6 and G-12.
Terminal bend radii and lead-in manufacturing option.



Dimensions are shown: Inches (mm)
Specifications and dimensions subject to change

7000 Series Miniature Rocker & Lever Handle Switches

TERMINATIONS

AV2 VERTICAL RIGHT ANGLE, PC THRU-HOLE,
.150" PITCH



7401J1AV2BE2
Vertical Actuation
4PDT

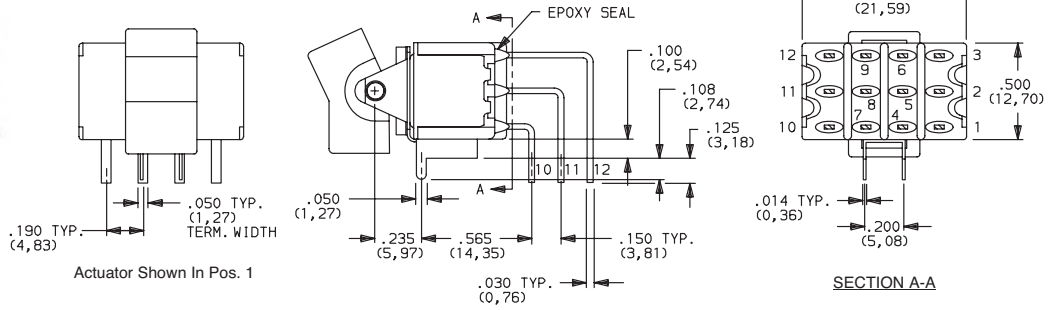

AV3 VERTICAL RIGHT ANGLE, SNAP-IN, PC THRU-HOLE,
.150" PITCH

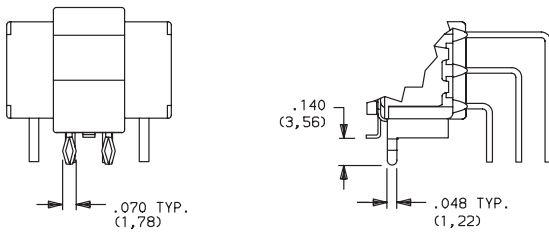

Not available with I seal option. Available actuators, see pages G-6 and G-12.
Terminal bend radii and lead-in manufacturing option.

PC MOUNTING

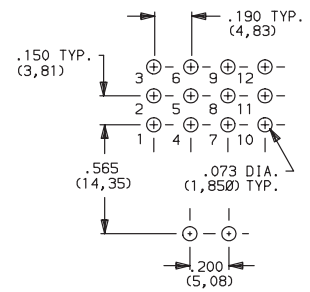

V5 VERTICAL RIGHT ANGLE, PC THRU-HOLE,
.150" PITCH

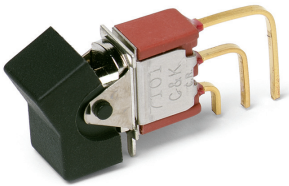

7101J1V5BE2
Vertical Actuation
SPDT

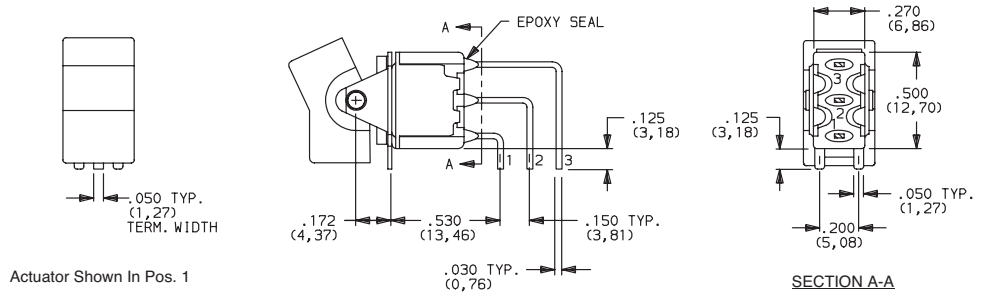

V51 VERTICAL RIGHT ANGLE, SNAP-IN,
PC THRU-HOLE, .150" PITCH

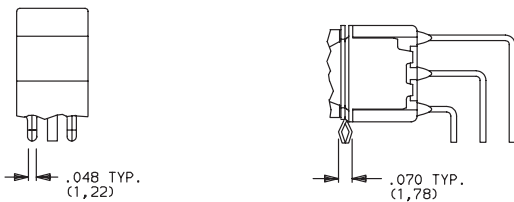

Not available with I seal option. Available actuators, see pages G-6 and G-12.
Terminal bend radii and lead-in manufacturing option.

PC MOUNTING

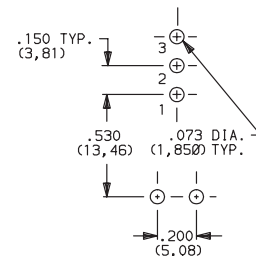

Dimensions are shown: Inches (mm)
Specifications and dimensions subject to change



7000 Series Miniature Rocker & Lever Handle Switches

TERMINATIONS

V5 VERTICAL RIGHT ANGLE, PC THRU-HOLE,
.150" PITCH

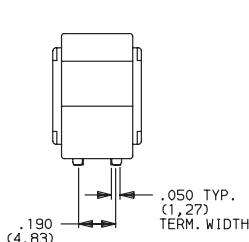

Actuator Shown In Pos. 1

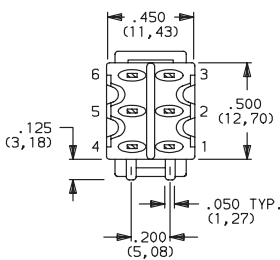
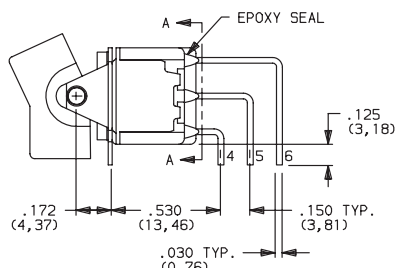

SECTION A-A



7201J1V5BE2
Vertical Actuation
DPDT

V51 VERTICAL RIGHT ANGLE, SNAP-IN,
PC THRU-HOLE, .150" PITCH

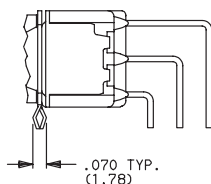
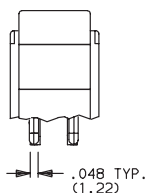

PC MOUNTING

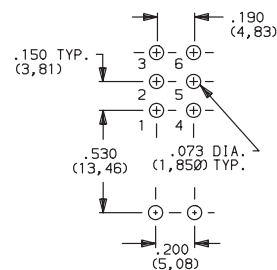

Not available with I seal option. Available actuators, see pages G-6 and G-12.
Terminal bend radii and lead-in manufacturing option.

V2, V6, V7, V8 VERTICAL MOUNT, V-BRACKET

V61 VERTICAL MOUNT, V-BRACKET, SNAP-IN

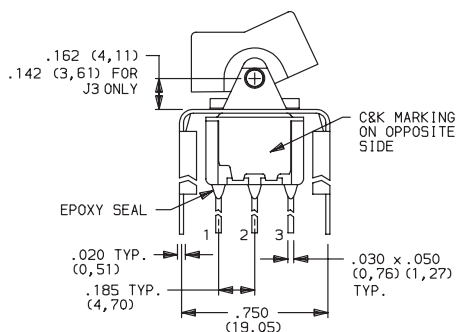

Actuator Shown In Pos. 1

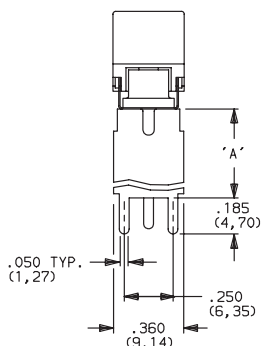

PC MOUNTING

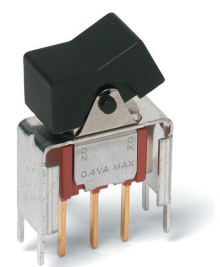
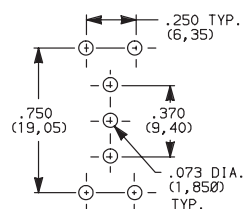

7101J1_BE2
SPDT

OPTION CODE	DIM 'A'
V2, V21	.555 (14,10)
V6, V61	.460 (11,68)
V7	.630 (16,00)
V8	.953 (24,21)



Dimensions are shown: Inches (mm)
Specifications and dimensions subject to change

7000 Series Miniature Rocker & Lever Handle Switches

TERMINATIONS

V2, V6, V7, V8 VERTICAL MOUNT, V-BRACKET

V21, V61 VERTICAL MOUNT, V-BRACKET, SNAP-IN



7201J1_BE2
DPDT

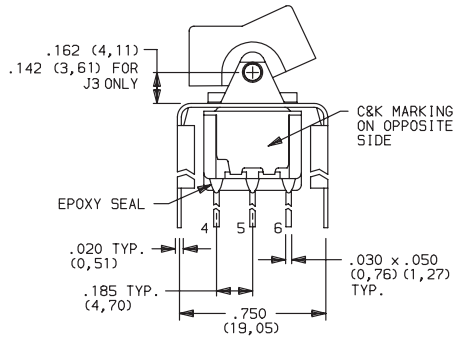

Actuator Shown In Pos. 1

PC MOUNTING

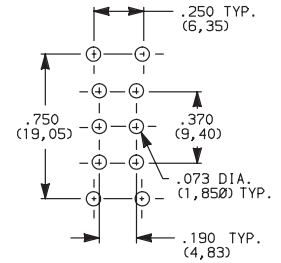

OPTION CODE	DIM 'A'
V2, V21	.555 (14,10)
V6, V61	.460 (11,68)
V7	.630 (16,00)
V8	.953 (24,21)

Not available with I seal option.
Available actuators, see pages G-6 and G-12.

V2, V7, V8 VERTICAL MOUNT, V-BRACKET

V21 VERTICAL MOUNT, V-BRACKET, SNAP-IN



7301J1_BE2
3PDT

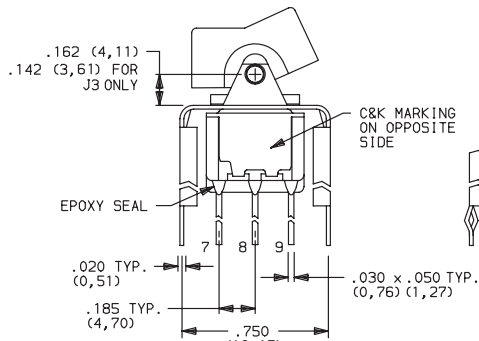

Actuator Shown In Pos. 1

PC MOUNTING

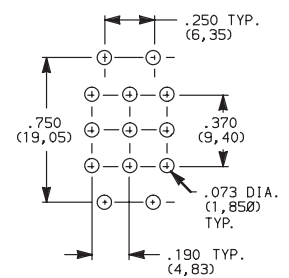

OPTION CODE	DIM 'A'
V2, V21	.555 (14,10)
V7	.630 (16,00)
V8	.953 (24,21)

Not available with I seal option.
Available actuators, see pages G-6 and G-12.

V2, V7, V8 VERTICAL MOUNT, V-BRACKET

V21 VERTICAL MOUNT, V-BRACKET, SNAP-IN

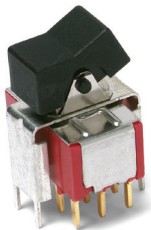

7401J1_BE2
4PDT

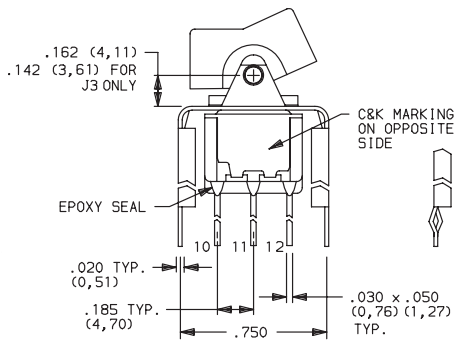

Actuator Shown In Pos. 1

PC MOUNTING

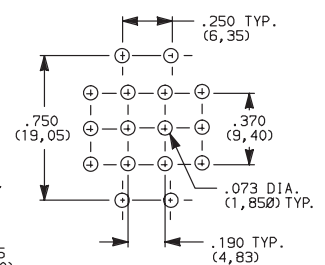

OPTION CODE	DIM 'A'
V2, V21	.555 (14,10)
V7	.630 (16,00)
V8	.953 (24,21)

Not available with I seal option.
Available actuators, see pages G-6 and G-12.



Dimensions are shown: Inches (mm)
Specifications and dimensions subject to change



7000 Series Miniature Rocker & Lever Handle Switches

TERMINATIONS

V3, V4, V9 VERTICAL MOUNT, V-BRACKET

V31 VERTICAL MOUNT, V-BRACKET, SNAP-IN



7101J1_BE2
SPDT

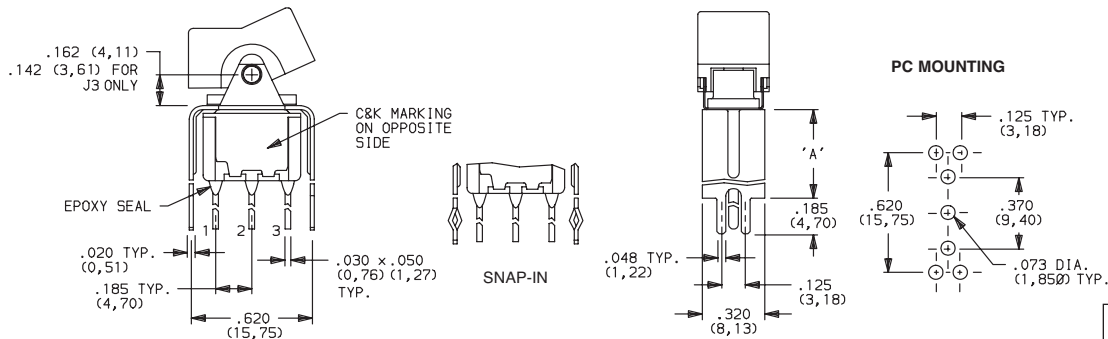

Actuator Shown In Pos. 1

OPTION CODE	DIM 'A'
V3, V31	.460 (11,68)
V4	.630 (16,00)
V9	1.150 (29,21)

Not available with I seal option.
Available actuators, see pages G-6 and G-12.

V3, V4, V9 VERTICAL MOUNT, V-BRACKET

V31 VERTICAL MOUNT, V-BRACKET, SNAP-IN

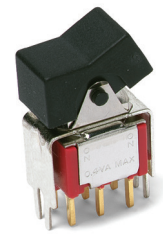

7201J1_BE2
DPDT

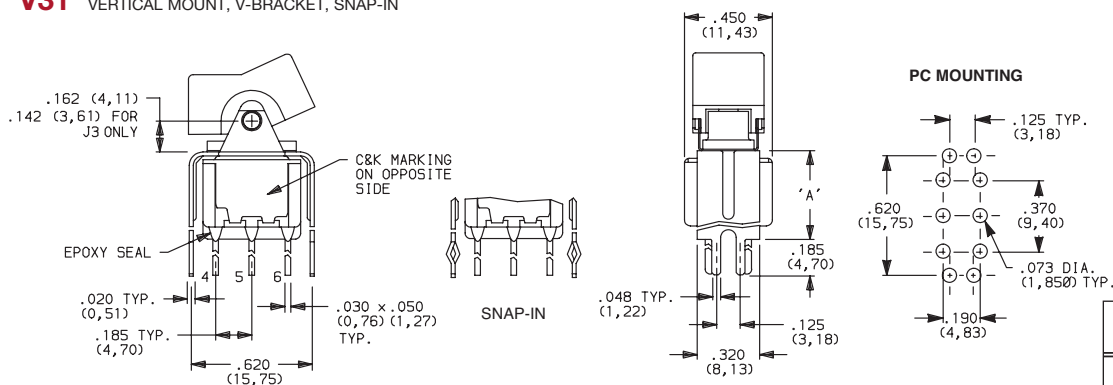

Actuator Shown In Pos. 1

OPTION CODE	DIM 'A'
V3, V31	.460 (11,68)
V4	.630 (16,00)
V9	1.150 (29,21)

Not available with I seal option.
Available actuators, see pages G-6 and G-12.

V4, V9 VERTICAL MOUNT, V-BRACKET



7301J1_BE2
3PDT

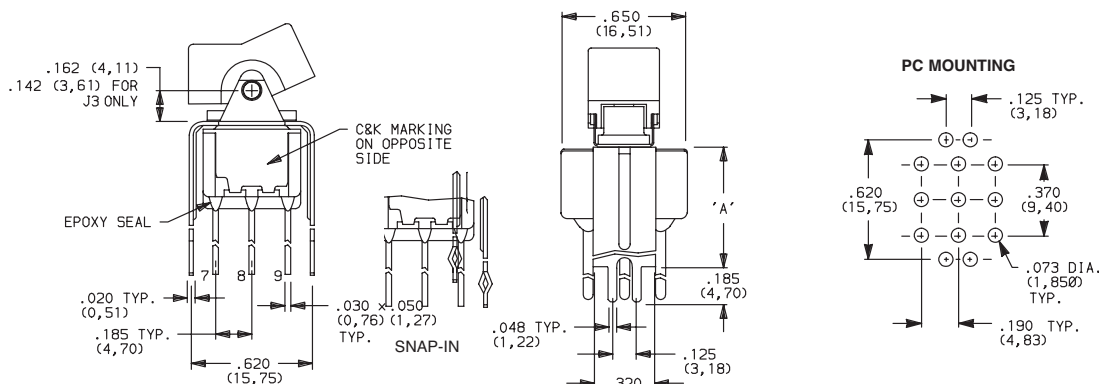

Actuator Shown In Pos. 1

OPTION CODE	DIM 'A'
V4	.630 (16,00)
V9	1.150 (29,21)

Not available with I seal option.
Available actuators, see pages G-6 and G-12.

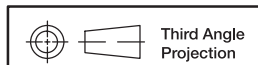

Dimensions are shown: Inches (mm)
Specifications and dimensions subject to change

Rocker



7000 Series Miniature Rocker & Lever Handle Switches

TERMINATIONS

V4, V9 VERTICAL MOUNT, V-BRACKET



7401J1_BE2
4PDT

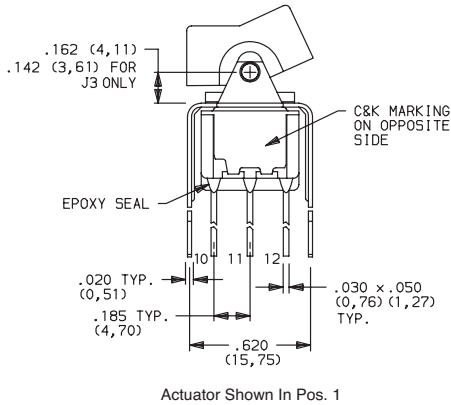

Actuator Shown In Pos. 1

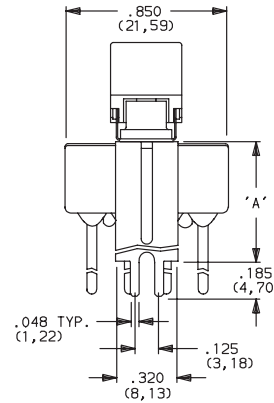

PC MOUNTING

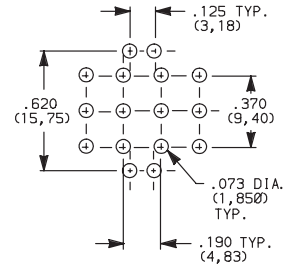

OPTION CODE	DIM 'A'
V4	.630 (16,00)
V9	1.150 (29,21)

Not available with I seal option.
Available actuators, see pages G-6 and G-12.

CONTACT MATERIAL

OPTION CODE	CONTACT MATERIAL	TERMINAL PLATING	RATINGS	
B	GOLD ¹	GOLD ¹	LOW LEVEL/ DRY CIRCUIT	0.4 VA MAX. @ 20 V AC OR DC MAX.
P		MATTE-TIN ⁶		
Q	SILVER ^{4,5}	SILVER ⁵	POWER	5 AMPS @ 120 V AC OR 28 V DC; 2 AMPS @ 250 V AC.
S		MATTE-TIN ⁶		
G	GOLD OVER SILVER ^{2,3}	GOLD ³	LOW LEVEL/DRY CIRCUIT OR POWER	0.4 VA MAX @ 20 V AC OR DC MAX OR 5 AMPS @ 120 V AC OR 28 V DC; 2 AMPS @ 250 V AC.
R		MATTE-TIN ⁶		

* Note: See Technical Data section of this catalog for RoHS compliant and compatible definitions and specifications.

- CONTACTS & TERMINALS: Copper alloy, with gold plate over nickel plate.
- END CONTACTS: Coin silver, with gold plate over nickel plate.
- CENTER CONTACTS & ALL TERMINALS: Copper alloy, with gold plate over nickel plate.
- END CONTACTS: Coin silver, silver plated.
- CENTER CONTACT & ALL TERMINALS: Copper alloy, silver plated.
- TERMINALS: Copper alloy, with matte-tin over nickel plate.

U11-U415 model numbers **CALUS** with all options when ordered with G, Q, S & R contact material.

B contact material standard with all terminations except C, Z & Z3.
Q contact material standard with C, Z & Z3 terminations.

P, S & R, contact materials not available with Z & Z3 terminations.

NOTE: Any models supplied with Q, B, G S, P & R contact material are RoHS compliant.

SEAL

E EPOXY SEAL

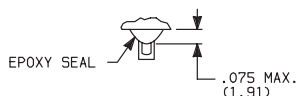

I EPOXY POTTED BASE

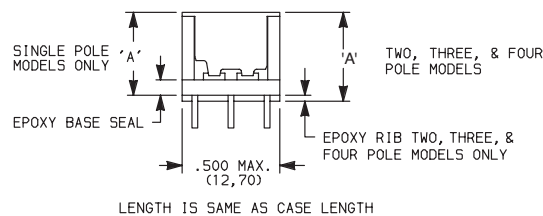

Available with C, W through W5, Z & Z3 terminations.

NO. POLES	DIM 'A'
SP	.410 (10,41)
DP	.440 (11,18)
3P	.505 (12,83)
4P	.505 (12,83)

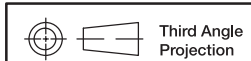

Dimensions are shown: Inches (mm)
Specifications and dimensions subject to change



7000 Series Miniature Rocker & Lever Handle Switches

AVAILABLE HARDWARE

Panel mounting hardware for rocker and lever handle switches is available separately. Mounting hardware consists of two screws, two nuts, two standoffs and two lockwashers per switch, and is available for panel thicknesses of 1/16, 3/32 and 1/8 inch. See part numbers below.

Qty	Part Number	Description
2	761103000	Standoffs
2	764100000	Mounting screws
2	764200000	Lock washers
2	764300000	Hex nuts

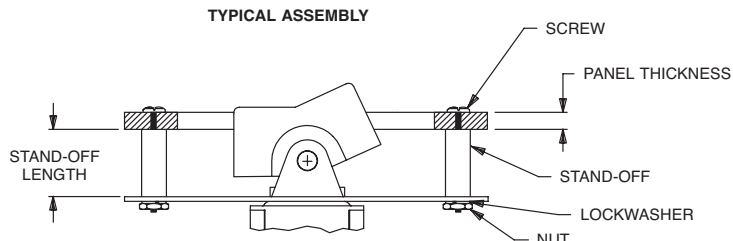

J1 & J2 actuators

PART NO.	PANEL THK.	STANDOFF LENGTH
761103000	1/8 IN. (3,18)	.233 (5,92)

J3 actuators

PART NO.	PANEL THK.	STANDOFF LENGTH
770603000	1/8 IN. (3,18)	.233 (5,92)

J10 actuators

PART NO.	PANEL THK.	STANDOFF LENGTH
770703000	1/8 IN. (3,18)	.233 (5,92)

MATERIAL

Screws, nuts, lockwashers: Stainless steel. Standoffs: Nylon, standard.

J1, J11, J15 & J16 Actuators



PART NO.
776A01000 WHITE
776A02263 BLACK
776A03000 RED

Material: Nylon
Finish: Matte

J2, J21, J25 & J26 Actuators



PART NO.
426D01000 WHITE
426D02263 BLACK
426D03000 RED

Material: Nylon
Finish: Matte

J3 & J37 Actuators



PART NO.
431D01000 WHITE
431D02263 BLACK
431D03000 RED

Material: Nylon
Finish: Matte

J50, J51 & J52 Actuators

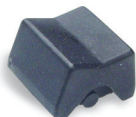

PART NO.
775A01000 WHITE
775A02263 BLACK
775A03000 RED

Material: Nylon
Finish: Matte

J60, J61 & J62 Actuators



PART NO.
598101000 WHITE
613802263 BLACK
598103000 RED

Material: Nylon
Finish: Matte



7000 Series Miniature Rocker & Lever Handle Switches

AVAILABLE HARDWARE

J90 & J91 Actuators



PART NO.
598001000 WHITE
598002263 BLACK
598003000 RED

Material: Nylon
 Finish: Matte

J10 & J19 Actuators



PART NO.
769501000 WHITE
769502263 BLACK
769503000 RED

Material: Nylon
 Finish: Matte

Fits Z3 Termination female connector



PART NO.
530100000

Available in loose pieces.

Frame for J11 & J21 Actuators



PART NO.
764500746 BLACK ENAMEL
764500747 WHITE ENAMEL
764601106 RETAINING SPRING

Material: Spring Steel

Frame for J16 & J26 Actuators



PART NO.
459101000 WHITE
459102000 BLACK
459103000 RED

Material: Nylon
 Finish: Matte

Frame for J51, J61 & J91 Actuators



PART NO.
615601000 WHITE
615602263 BLACK
615603000 RED

Material: Nylon
 Finish: Matte

Frame for J19 Actuator



PART NO.
781000746 BLACK ENAMEL
781000747 WHITE ENAMEL

Material: Spring Steel

Frame for J37 Actuator



PART NO.
445400746 BLACK ENAMEL

Material: Spring Steel

Frame for J52 & J62 Actuators

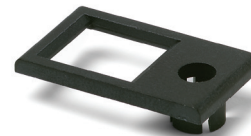

PART NO.
613301000 WHITE
613302263 BLACK
613303000 RED

Material: Nylon
 Finish: Matte

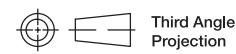

Dimensions are shown: Inches (mm)
 Specifications and dimensions subject to change



7000 Series Miniature Rocker & Lever Handle Switches

AVAILABLE HARDWARE

Frames snap into panel opening and are independent from switch mounting. Accurate positioning of the PC mounted switch relative to the panel opening is necessary to provide proper clearance between actuator and frame. Available in two basic styles and four panel thicknesses .047-.125 in. Material: Nylon. Finish: Matte.

TYPICAL APPLICATION

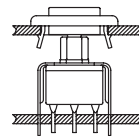

J1 & J2 Actuators

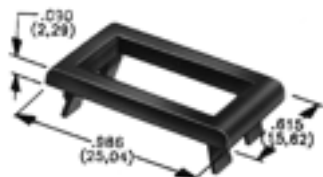

.047" (1,19) PANEL THK. .062" (1,57) PANEL THK. .090" (2,29) PANEL THK. .125" (3,18) PANEL THK.

PART NO. PART NO. PART NO. PART NO.
452902263 **452702263** **452802263** **452602263** BLACK

J50, J60 & J90 Actuators

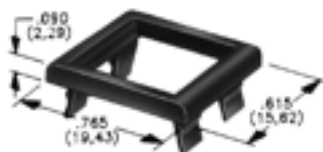

.047" (1,19) PANEL THK. .062" (1,57) PANEL THK. .090" (2,29) PANEL THK. .125" (3,18) PANEL THK.

PART NO. PART NO. PART NO. PART NO.
432502263 **432602263** **432702263** **432802263** BLACK

PANEL MOUNTING

For part numbers
 4529xxxxx, 4527xxxxx,
 4528xxxxx, 4526xxxxx

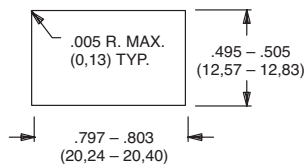

For part numbers
 4325xxxxx, 4326xxxxx

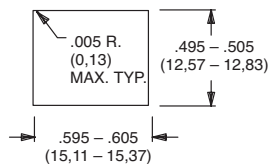

For part numbers
 4327xxxxx, 4328xxxxx

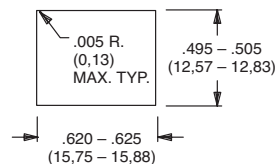

Rocker



G



27 mar 17

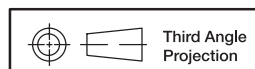

Dimensions are shown: Inches (mm)
 Specifications and dimensions subject to change

7000 Series Miniature Rocker & Lever Handle Switches

AVAILABLE HARDWARE

Panel Inserts

Will fit Separate Snap-in frames for J50, J60 & J90 actuators

Above frames (part nos. 432XXXXXX) are also available with insert which accepts LED for indicator light assembly. Order insert separately from frame. Blank insert panel (without hole for LED) also available. **LED not included.**

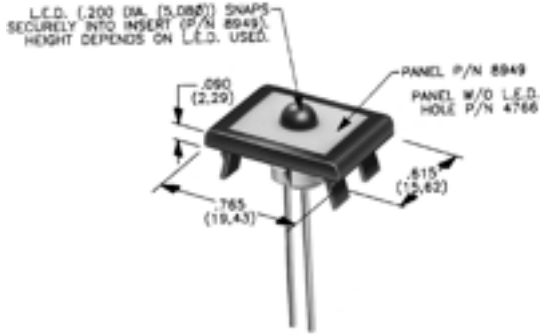

PANEL INSERT
WITH HOLE FOR LED

PART NO.
894902000

BLANK PANEL INSERT
WITHOUT HOLE FOR LED

PART NO.
476602000 BLACK

NOTE: Special colors, custom markings available, consult Customer Service Center.

LED INFORMATION

Process Information: Soldering to LED leads must be completed within 5 seconds at 500° F (260°C) maximum.

LEDs are not supplied with J52, J62 options. LED snaps into switch frame surrounding actuator and is wired externally.

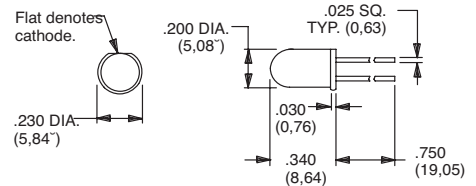

Suggested LED for J52 & J62 options.
Dimensions for reference only.

E Series Sealed Miniature Rocker and Lever Handle Switches

Features/Benefits

- Sealed against solder and cleaning process contaminants
- ESD Resistance—all actuator options
- Rocker, case & bushing UL 94V-0
- RoHS compliant

Typical Applications

- Telecommunications
- Instrumentation
- Computers & peripherals

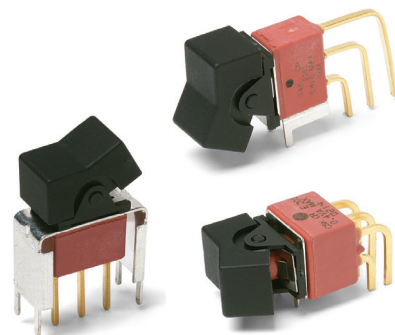

Specifications

CONTACT RATING: B contact material: 0.4 VA max. @ 20 V AC or DC max. Q contact material (E1XX & E2XX Models): 7.5 AMPS @ 125 V AC or 28 V DC; 3 AMPS @ 250 V AC. (E3XX Models): 5 AMPS @ 125 V AC or 28 V DC; 2 AMPS @ 250 V AC. See page G-36 for additional ratings.

ELECTRICAL LIFE: E1XX and E2XX models: 40,000 make-and-break cycles at full load. E3XX models: 30,000 cycles.

CONTACT RESISTANCE: Below 10 m Ω typ. initial @ 2-4 V DC, 100 mA, for both silver and gold plated contacts.

INSULATION RESISTANCE: 10⁹ Ω min.

ELECTROSTATIC DISCHARGE (ESD) OPTION: All actuator options: 15,000 V DC max. @ sea level, actuator to terminals.

DIELECTRIC STRENGTH: 1000 Vrms min. @ sea level.

OPERATING TEMPERATURE: -30°C to 85°C.

SOLDERABILITY: Per MIL-STD-202F method 208D, or EIA RS-186E method 9 (1 hour steam aging).

Materials

CASE & BUSHING: Glass filled nylon 6/6, flame retardant, heat stabilized (UL 94V-0).

ACTUATOR: Nylon, black standard, internal o-ring seal standard with all actuators.

FRAME: Spring steel, black standard.

SWITCH SUPPORT: Brass or steel, matte-tin plated.

ACTUATOR PIVOT & MOUNTING BRACKET: Nylon.

ACTUATOR PIVOT RETAINER: Stainless steel.

CONTACTS & TERMINALS: B contact material: Copper alloy, with gold plate over nickel plate. Q contact material: Copper alloy, silver plated. See page G-36 for additional contact materials.

TERMINAL SEAL: Epoxy.

HARDWARE: Nut, Screw & Lockwasher: Stainless steel. Standoff: Nylon standard, aluminum available, consult Customer Service Center.

NOTE: Any models supplied with Q, B, G, S, P & R contact material are RoHS compliant.

NOTE: Specifications and materials listed above are for switches with standard options. For information on specific and custom switches, consult Customer Service Center.

Build-A-Switch

To order, simply select desired option from each category and place in the appropriate box. Available options are shown and described on pages G-26 through G-38. For additional options not shown in catalog, consult Customer Service Center. All models are process sealed to withstand machine soldering temperatures and pressure wash cleaning methods.

<p>Switch Function</p> <p>E101 SP On-None-On E103 SP On-Off-On E105 SP Mom.-Off-Mom. E107 SP On-Off-Mom. E108 SP On-None-Mom. E201 DP On-None-On E203 DP On-Off-On E205 DP Mom.-Off-Mom. E207 DP On-Off-Mom. E208 DP On-None-Mom. E211 DP On-On-On E213 DP On-On-Mom. E215 DP Mom.-On-Mom. E301 3P On-None-On</p>	<p>Actuator</p> <p>J1 .531" long rocker J2 Lever J3 .906" long rocker J11 Rocker with frame J21 Lever with frame J50 .362" long rocker J60 Lever J90 Lever</p>	<p>Terminations</p> <p>A Right angle, PC thru-hole AV2 Vertical right angle, PC thru-hole C PC Thru-hole Z Solder lug A3 Right angle, snap-in, PC thru-hole AV3 Vertical right angle, snap-in, PC thru-hole V3 .460" high, V-bracket V4 .630" high, V-bracket V5 Vertical right angle, PC thru-hole V6 .460" high, V-bracket V7 .630" high, V-bracket V8 .953" high, V-bracket V21 .555" high, V-bracket, snap-in V31 .460" high, V-bracket, snap-in</p>	<p>Contact Material</p> <p>B Gold P Gold, matte tin Q Silver S Silver, matte-tin G Gold over silver R Gold over silver, matte-tin</p> <p>Seal</p> <p>E Epoxy</p> <p>Actuator Color</p> <p>2 Black 3 Red</p> <p>Frame Color</p> <p>2 Black NONE No frame color required</p> <p>Metal Frame Color (J11, J21 Actuators) 2 Black</p>
---	--	--	--

Rocker



G



Dimensions are shown: Inches (mm)
Specifications and dimensions subject to change

E Series Sealed Miniature Rocker and Lever Handle Switches

SWITCH FUNCTION



NO. POLES	MODEL NO.	SWITCH FUNCTION			CONNECTED TERMINALS			SCHEMATIC
		POS. 1	POS. 2	POS. 3	POS. 1	POS. 2	POS. 3	
		C&K marking on opposite side			C&K marking on opposite side			
SP	E101	ON	NONE	ON	2-3	N/A	2-1	
	E103	ON	OFF	ON				
	E105	MOM.	OFF	MOM.				
	E107	ON	OFF	MOM.				
	E108	ON	NONE	MOM.				

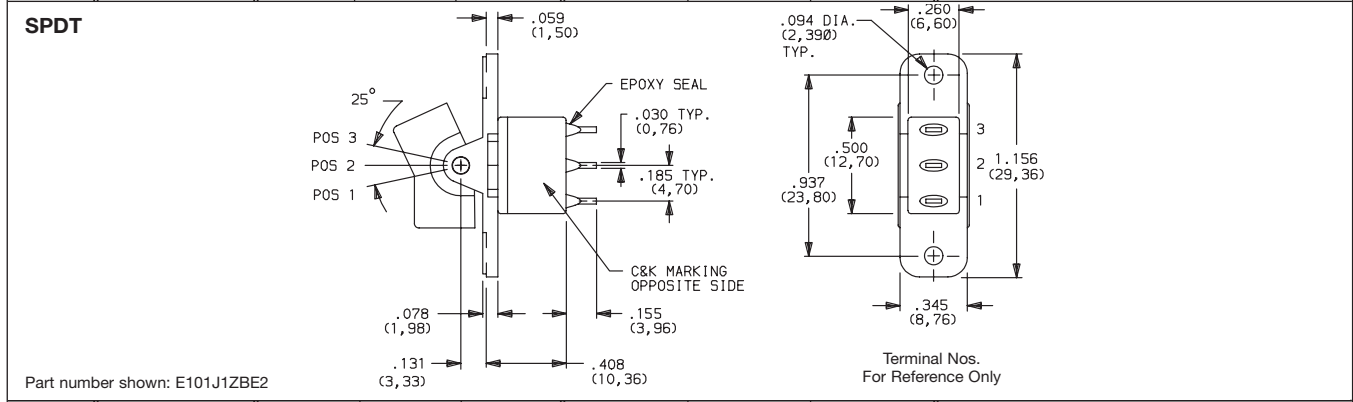

DP	E201	ON	NONE	ON	2-3,5-6	N/A	2-1,5-4	
	E203	ON	OFF	ON				
	E205	MOM.	OFF	MOM.				
	E207	ON	OFF	MOM.				
	E208	ON	NONE	MOM.				
	E211**	ON	ON	ON				
	E213**	ON	ON	MOM.				
	E215**	MOM.	ON	MOM.				

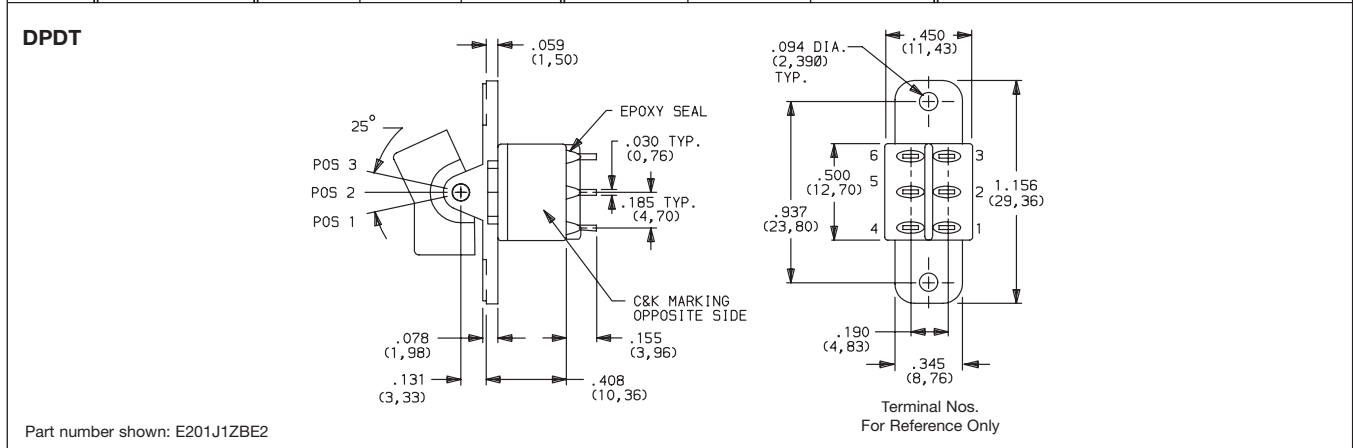

MOM. = Momentary

** Wiring for 3-way switch, Hardware available separately, see Technical Data section of this catalog.

All models with all options when ordered with G, Q, R or S contact material.

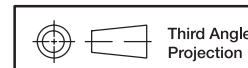

Third Angle Projection
Dimensions are shown: Inches (mm)
Specifications and dimensions subject to change



E Series Sealed Miniature Rocker and Lever Handle Switches

SWITCH FUNCTION

NO. POLES	MODEL NO.	SWITCH FUNCTION			CONNECTED TERMINALS			SCHEMATIC
		POS. 1	POS. 2	POS. 3	POS. 1	POS. 2	POS. 3	
		C&K marking on opposite side			C&K marking on opposite side			
3P	E301	ON	NONE	ON	2-3-5-6-8-9	N/A	2-1-5-4-8-7	<p style="text-align: center;">3PDT</p>
3PDT								Terminal Nos. For Reference Only
Part number shown: E301J1ZBE2								

MOM. = Momentary

** Wiring for 3-way switch, see Technical Data section of this catalog.

All models with all options when ordered with G, Q, R and S contact material.

ACTUATOR-PANEL REAR MOUNT

OPTION CODE	ACTUATOR COLOR
2	BLACK
3	RED

Finish: Matte. Other colors, custom actuator markings and legends available, consult Customer Service Center.

NOTE: Hardware: two each—mounting screws, nuts, lockwashers and standoffs for 1/8 inch thick panel are supplied standard on switches with panel mounting bracket. Internal o-ring actuator seal standard. Actuators available separately, see page G-36. Hardware available separately, see Technical Data section of this catalog. J1, J2 actuators available with C, Z or Z3 terminations.

J1 LEVER

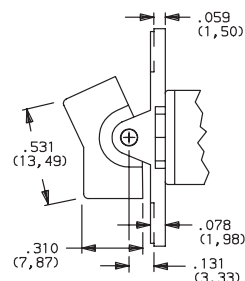
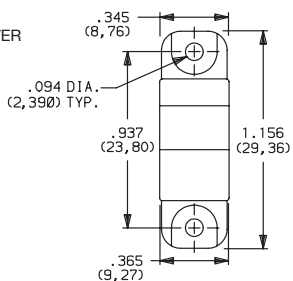

J2 LEVER

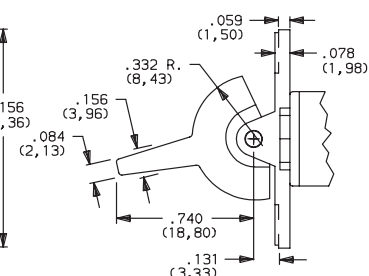
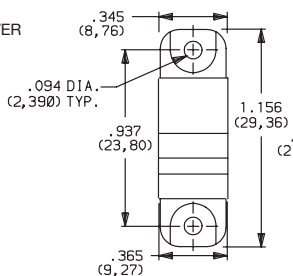

PANEL MOUNTING

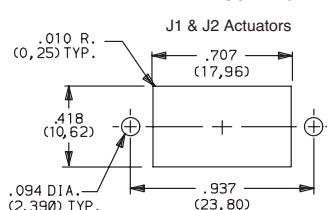

Rocker



Third Angle Projection

Dimensions are shown: Inches (mm)
Specifications and dimensions subject to change



E Series Sealed Miniature Rocker and Lever Handle Switches

ACTUATOR-REAR MOUNT

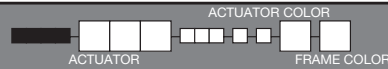

J11 ROCKER WITH FRAME

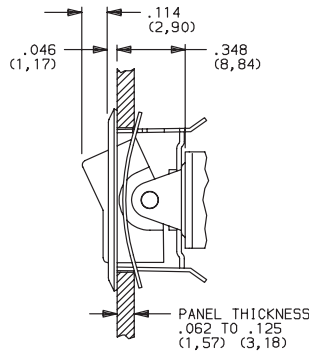
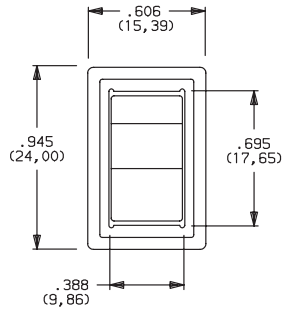

OPTION CODE	ACTUATOR COLOR
2	BLACK
3	RED

OPTION CODE	FRAME COLOR
2	BLACK

NOTE: This option has reduced anti-static capability.

J21 LEVER WITH FRAME

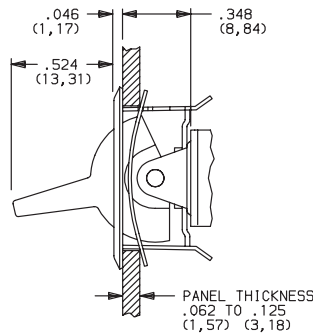
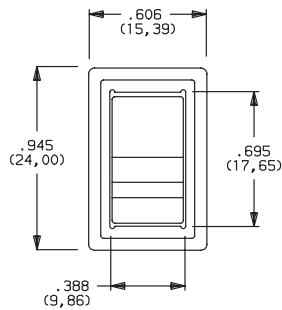

Actuator finish: Matte, frame finish: gloss. Other colors, custom actuator markings and legends available, consult Customer Service Center.

NOTE: Internal o-ring actuator seal standard. Actuators & frames available separately, see page G-36. Hardware available separately, see Technical Data section of this catalog. N. J11 & J21 actuators available with C, Z & Z3 terminations.

NOTE: This option has reduced anti-static capability.

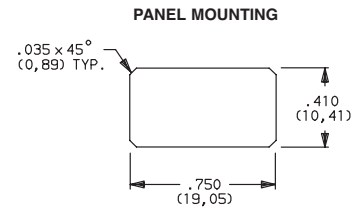

ACTUATOR-PC MOUNT

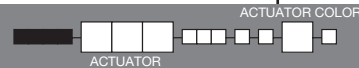

J1 ROCKER

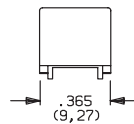
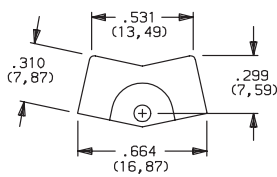

OPTION CODE	ACTUATOR COLOR
2	BLACK
3	RED

J2 LEVER

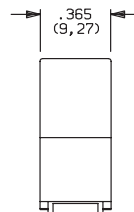
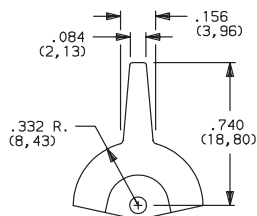

Finish: Matte. Other colors, custom actuator markings and legends available, consult Customer Service Center.

NOTE: Hardware: two each—mounting screws, nuts, lockwashers and standoffs for 1/8 inch thick panel are supplied standard on switches with panel mounting bracket. Internal o-ring actuator seal standard. Actuators available separately, see page G-36. Hardware available separately, see Technical Data section of this catalog. J1, J2 actuators available with A, A3, AV2, AV3, V2-V61 terminations.

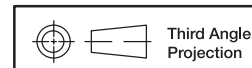

Third Angle Projection

Dimensions are shown: Inches (mm)
Specifications and dimensions subject to change

E Series Sealed Miniature Rocker and Lever Handle Switches

ACTUATOR-PC MOUNT

ACTUATOR COLOR

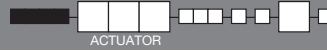

OPTION CODE	ACTUATOR COLOR
2	BLACK
3	RED

Finish: Matte. Other colors, custom actuator markings and legends available, consult Customer Service Center.

NOTE: Hardware: two each—mounting screws, nuts, lockwashers and standoffs for 1/8 inch thick panel are supplied standard on switches with panel mounting bracket. Internal o-ring actuator seal standard. Actuators available separately, see page G-36. Hardware available separately, see Technical Data section of this catalog.

J3 actuators available with AV2, AV3 & V2-V61 terminations. Some permissible actuator/termination combinations may lack clearance between actuator and PC board, and care must be exercised to accommodate this condition.

J50, J60 & J90 actuators available with A, AV2, AV3, V2 – V61 terminations.

J3 ROCKER

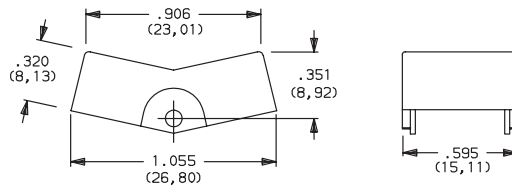

J50 ROCKER

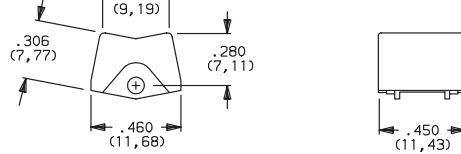

J60 LEVER

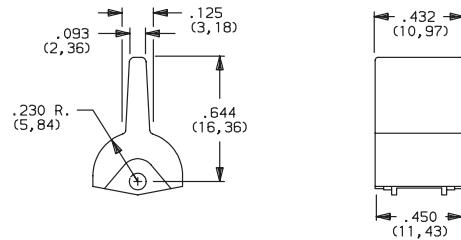

J90 LEVER

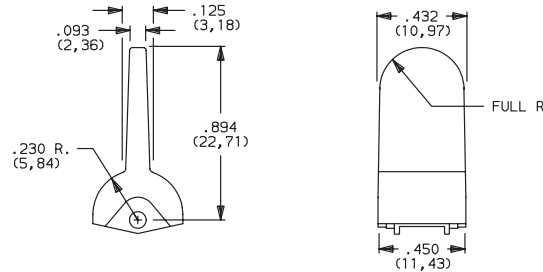

TERMINATIONS

Z SOLDER LUG

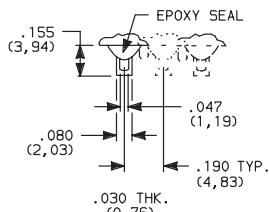

SPDT thru 3PDT

Not available with P, S, & R contact materials. Available actuators, see page G-27-28.

C PC THRU-HOLE

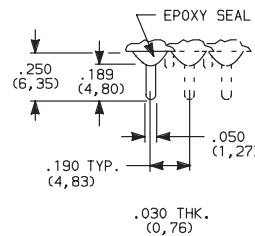

SPDT thru 3PDT

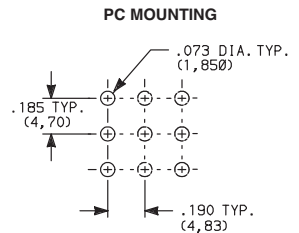

Dimensions are shown: Inches (mm)
Specifications and dimensions subject to change

Rocker

G



E Series Sealed Miniature Rocker and Lever Handle Switches

TERMINATIONS

Z3 QUICK CONNECT

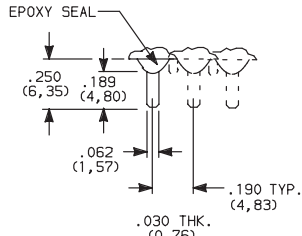

Not available with P, S, & R contact materials. Available actuators, see pages G-27 thru G-28. Mating quick connector available; order part number 530100000, page G-37.

SPDT thru 3PDT

A RIGHT ANGLE, PC THRU-HOLE

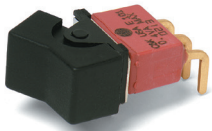

E101J1ABE2
Horizontal Actuation
SPDT

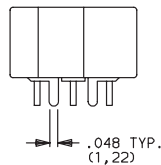

Actuator Shown In Pos. 1

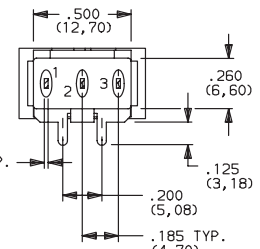
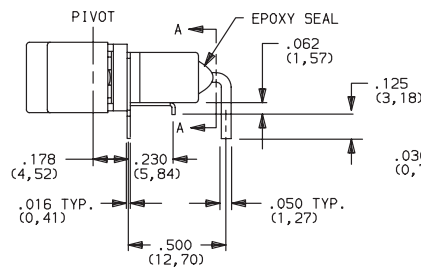

SECTION A-A

A3 RIGHT ANGLE, SNAP-IN, PC THRU-HOLE

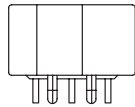

.050 TYP. (1,27)

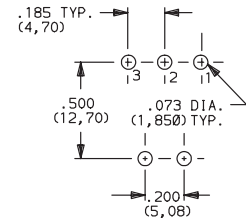
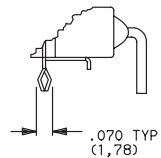

PC MOUNTING

NOTE: Not available with J3, J50, J60 and J90 actuators. Available actuators, see pages G-27 thru G-29. Terminal bend radii and lead-in manufacturing option.

NOTE: PC mounting pattern must clear switch support leg.

A RIGHT ANGLE, PC THRU-HOLE

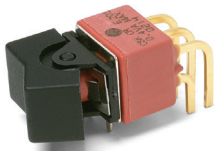

E201J1ABE2
Horizontal Actuation
DPDT

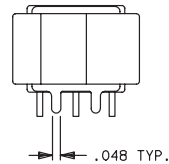

Actuator Shown In Pos. 1

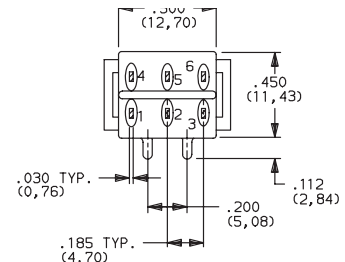
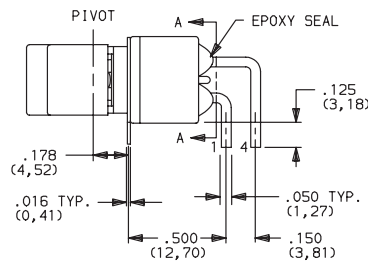

SECTION A-A

A3 RIGHT ANGLE, SNAP-IN, PC THRU-HOLE

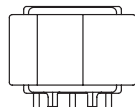

.048 TYP. (1,22)

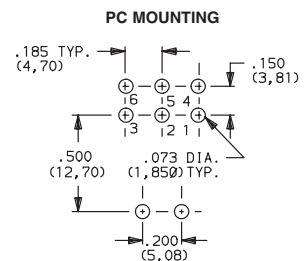
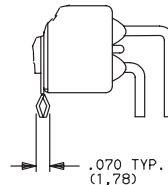

PC MOUNTING

NOTE: Not available with J3 actuator. Available actuators, see pages G-27 thru G-29. Terminal bend radii and lead-in manufacturing option.

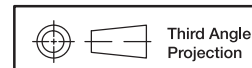

Third Angle Projection

Dimensions are shown: Inches (mm)
Specifications and dimensions subject to change



E Series Sealed Miniature Rocker and Lever Handle Switches

TERMINATIONS

A RIGHT ANGLE, PC THRU-HOLE

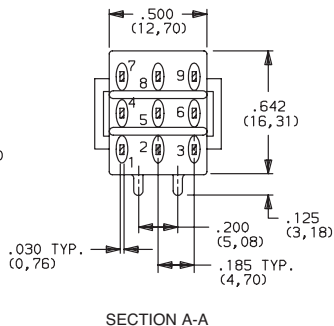
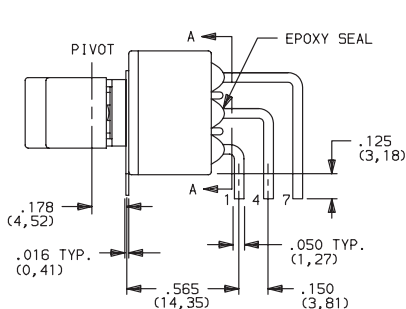
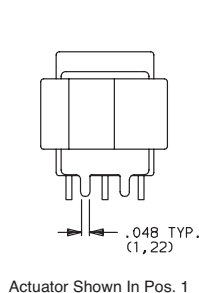

E301J1ABE2
Horizontal Actuation
3PDT

PC MOUNTING

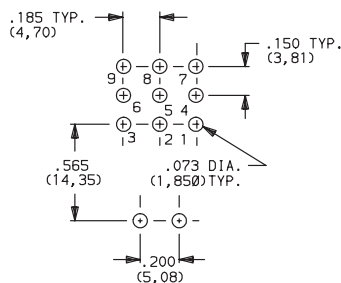

NOTE: Terminal bend radii and lead-in manufacturing option. Available actuators, see pages G-27 thru G-29.

AV2 VERTICAL RIGHT ANGLE, PC THRU-HOLE, .150" PITCH

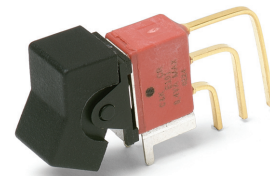
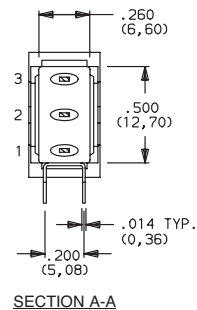
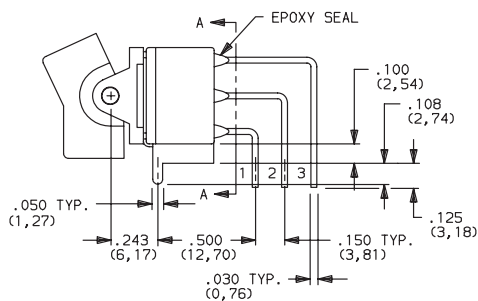
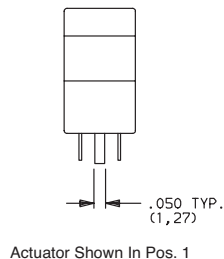

E101J1AV2BE2
Vertical Actuation
SPDT

AV3 VERTICAL RIGHT ANGLE, SNAP-IN, PC THRU-HOLE, .150" PITCH

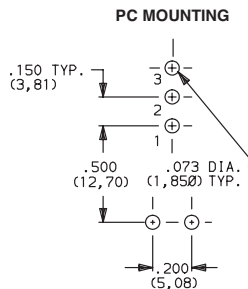
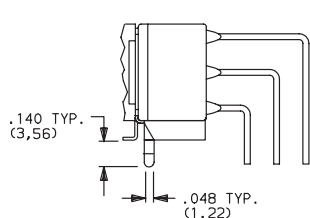
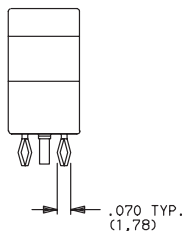

NOTE: Terminal bend radii and lead-in manufacturing option. Available actuators, see pages G-27 thru G-29.

Rocker

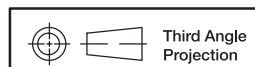

Dimensions are shown: Inches (mm)
Specifications and dimensions subject to change

E Series Sealed Miniature Rocker and Lever Handle Switches

TERMINATIONS



AV2 VERTICAL RIGHT ANGLE, PC THRU-HOLE,
.150" PITCH

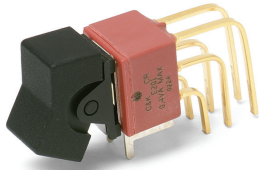

E201J1AV2BE2
Vertical Actuation
DPDT

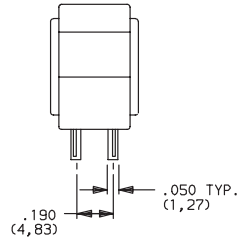

Actuator Shown In Pos. 1

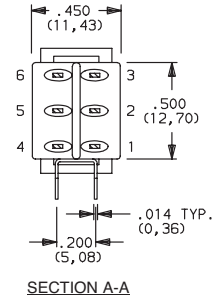
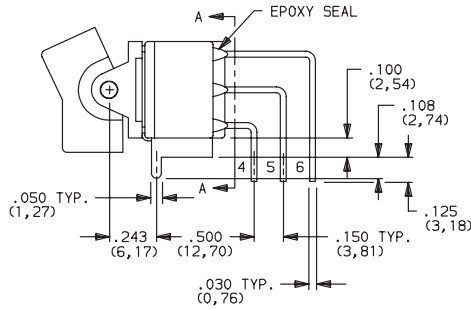

AV3 VERTICAL RIGHT ANGLE, SNAP-IN, PC THRU-HOLE,
.150" PITCH

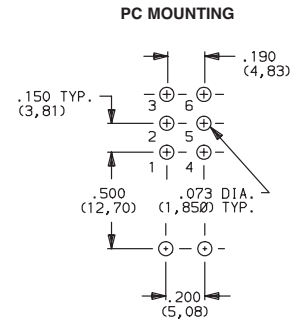
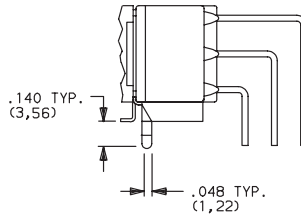
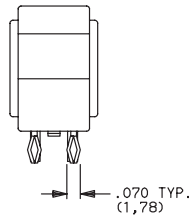

NOTE: Terminal bend radii and lead-in manufacturing option.
Available actuators, see pages G-27 thru G-29.

AV2 VERTICAL RIGHT ANGLE, PC THRU-HOLE,
.150" PITCH

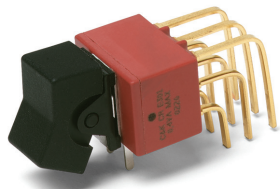

E301J1AV2BE2
Vertical Actuation
3PDT

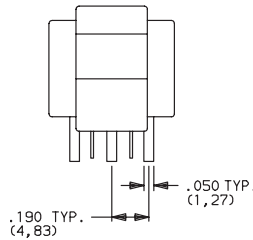

Actuator Shown In Pos. 1

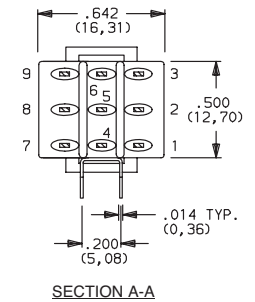
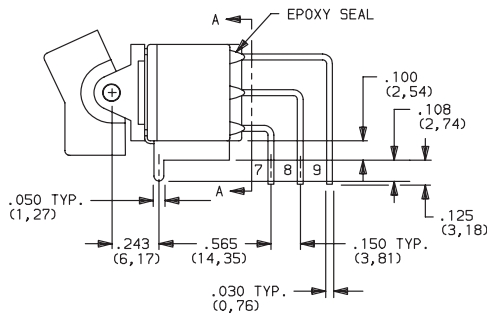

AV3 VERTICAL RIGHT ANGLE, SNAP-IN, PC THRU-HOLE,
.150" PITCH

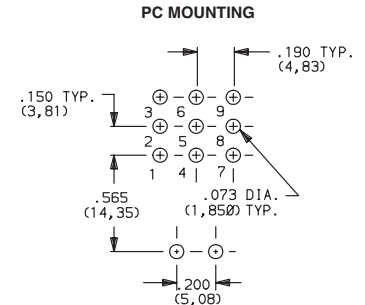
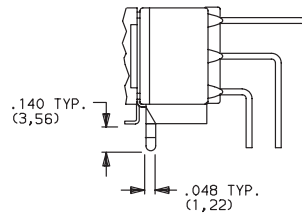
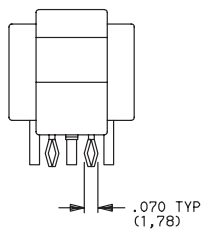

NOTE: Terminal bend radii and lead-in manufacturing option.
Available actuators, see pages G-27 thru G-29.



Dimensions are shown: Inches (mm)
Specifications and dimensions subject to change



E Series Sealed Miniature Rocker and Lever Handle Switches

TERMINATIONS

V5 VERTICAL RIGHT ANGLE, PC THRU-HOLE,
.150" PITCH

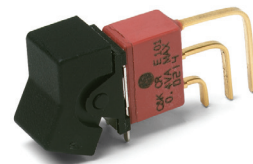
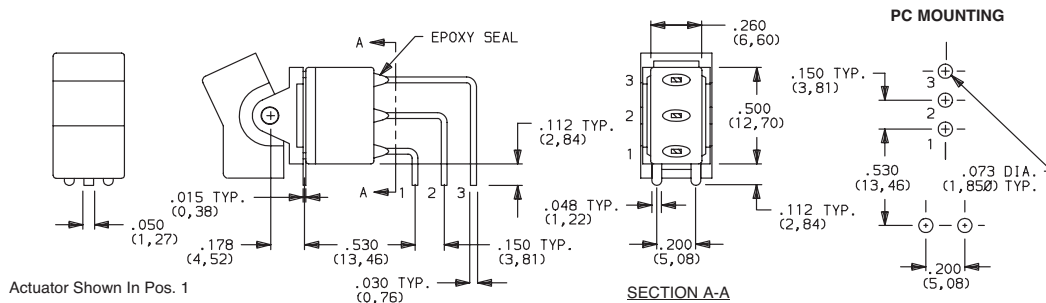

E101J1V5BE2
Vertical Actuation
SPDT

NOTE: Terminal bend radii and lead-in manufacturing option.
Available actuators, see pages G-27 thru G-29.

V5 VERTICAL RIGHT ANGLE, PC THRU-HOLE,
.150" PITCH

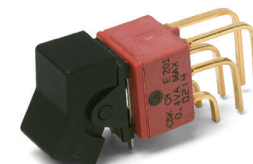
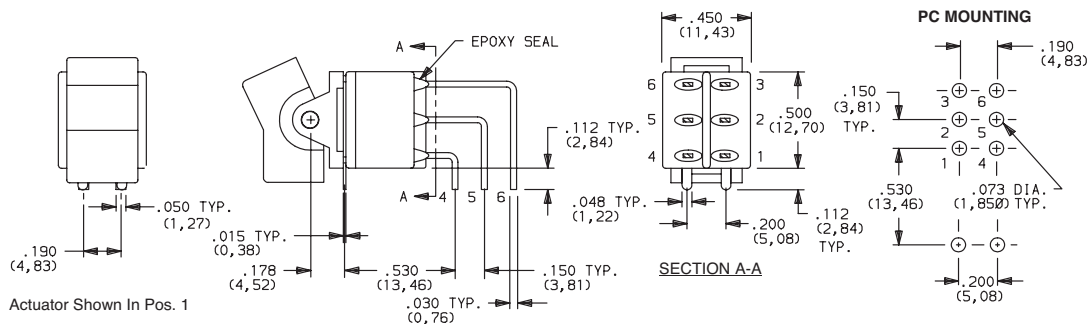

E201J1V5BE2
Vertical Actuation
DPDT

NOTE: Terminal bend radii and lead-in manufacturing option.
Available actuators, see pages G-27 thru G-29.



E Series Sealed Miniature Rocker and Lever Handle Switches

TERMINATIONS

V6, V7, V8 VERTICAL MOUNT, V-BRACKET

V21 VERTICAL MOUNT, V-BRACKET, SNAP-IN

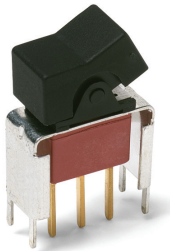

E101J1_BE2
SPDT

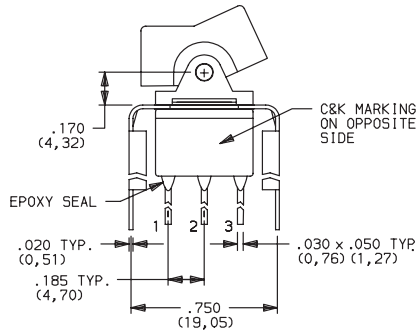

Actuator Shown In Pos. 1

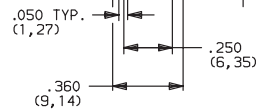
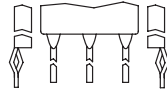

PC MOUNTING

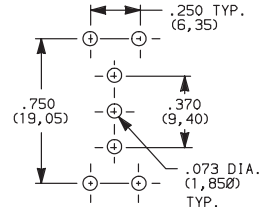

OPTION CODE	DIM 'A'
V21	.555 (14, 10)
V6	.460 (11, 68)
V7	.630 (16, 00)
V8	.953 (24, 21)

NOTE: Available actuators, see pages G-27 thru G-29.

V6, V7, V8 VERTICAL MOUNT, V-BRACKET

V21 VERTICAL MOUNT, V-BRACKET, SNAP-IN

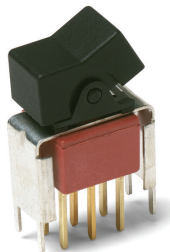

E201J1_BE2
DPDT

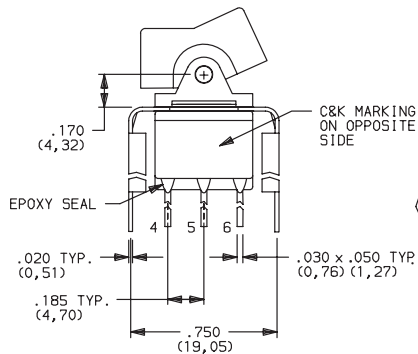

Actuator Shown In Pos. 1

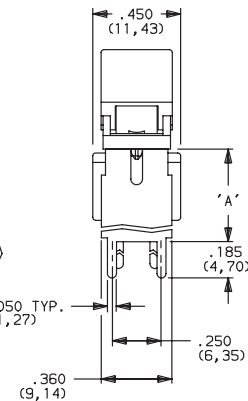
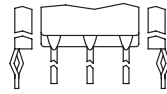

PC MOUNTING

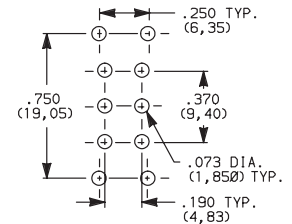

OPTION CODE	DIM 'A'
V21	.555 (14, 10)
V6	.460 (11, 68)
V7	.630 (16, 00)
V8	.953 (24, 21)

NOTE: Available actuators, see pages G-27 thru G-29.

V7, V8 VERTICAL MOUNT, V-BRACKET

V21 VERTICAL MOUNT, V-BRACKET, SNAP-IN

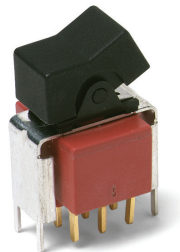

E301J1_BE2
3PDT

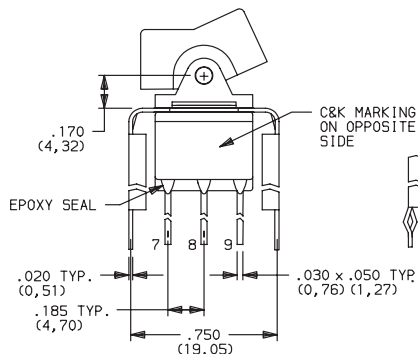

Actuator Shown In Pos. 1

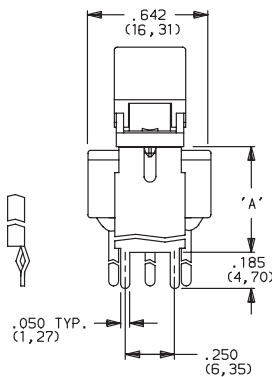
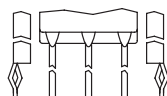

PC MOUNTING

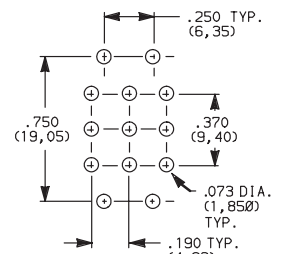

OPTION CODE	DIM 'A'
V21	.555 (14, 10)
V7	.630 (16, 00)
V8	.953 (24, 21)

NOTE: Available actuators, see pages G-27 thru G-29.

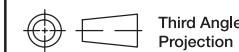

Dimensions are shown: Inches (mm)
Specifications and dimensions subject to change



E Series Sealed Miniature Rocker and Lever Handle Switches

TERMINATIONS

V3, V4 VERTICAL MOUNT, V-BRACKET

V31 VERTICAL MOUNT, V-BRACKET, SNAP-IN

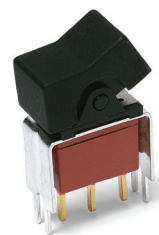

E101J1_BE2
SPDT

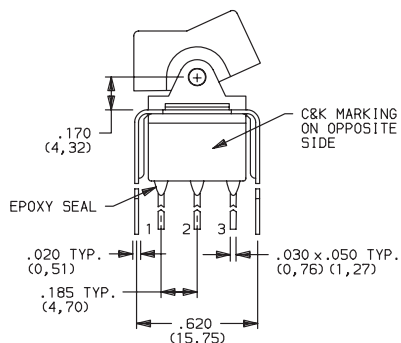

Actuator Shown In Pos. 1

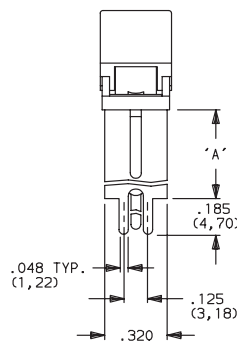
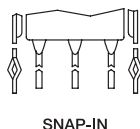

PC MOUNTING

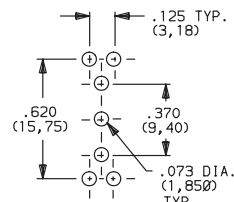

OPTION CODE	DIM 'A'
V3, V31	.460 (11,68)
V4	.630 (16,00)

NOTE: Available actuators, see pages G-27 thru G-29.

V3, V4 VERTICAL MOUNT, V-BRACKET

V31 VERTICAL MOUNT, V-BRACKET, SNAP-IN

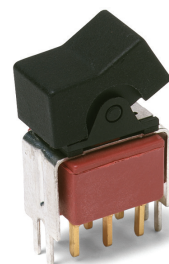

E201J1_BE2
DPDT

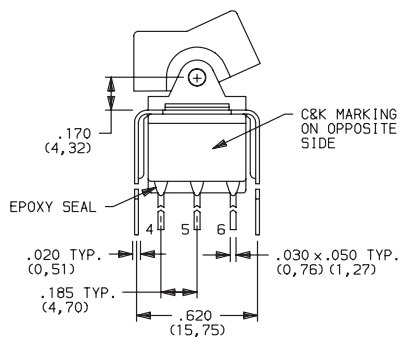

Actuator Shown In Pos. 1

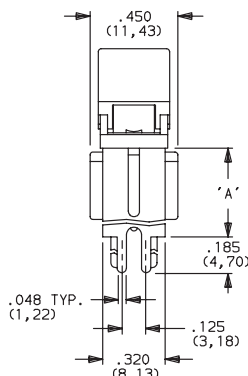
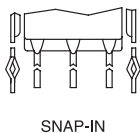

PC MOUNTING

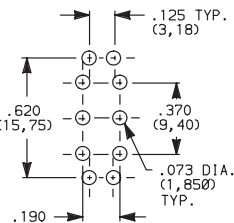

OPTION CODE	DIM 'A'
V3, V31	.460 (11,68)
V4	.630 (16,00)

NOTE: Available actuators, see pages G-27 thru G-29.

V4 VERTICAL MOUNT, V-BRACKET

VERTICAL MOUNT, V-BRACKET, SNAP-IN

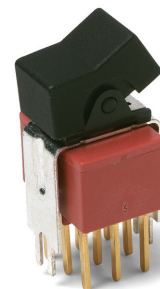

E301J1_BE2
3PDT

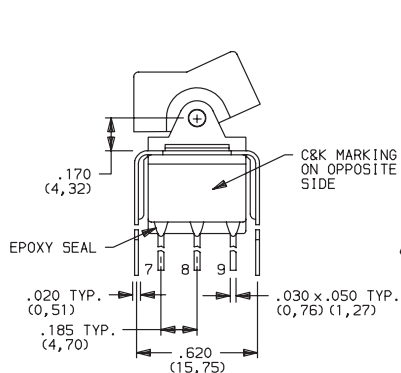

Actuator Shown In Pos. 1

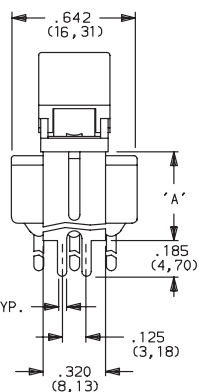
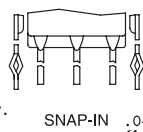

PC MOUNTING

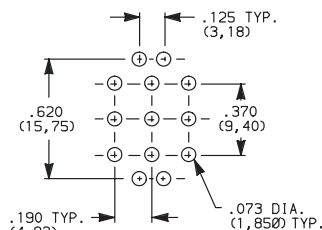

OPTION CODE	DIM 'A'
V41	.630 (16,00)

NOTE: Available actuators, see pages G-27 thru G-29.

Rocker



Third Angle Projection
Dimensions are shown: Inches (mm)
Specifications and dimensions subject to change



E Series Sealed Miniature Rocker and Lever Handle Switches

CONTACT MATERIAL

OPTION CODE	CONTACT MATERIAL	TERMINAL PLATING	RATINGS	
B	GOLD ¹	GOLD ¹	LOW LEVEL/ DRY CIRCUIT	0.4 VA MAX. @ 20 V AC OR DC MAX.
P		MATTE-TIN ⁷		
Q	SILVER ^{4,5}	SILVER ⁵	POWER	E1XX & E2XX MODELS: 7.5 AMPS @125 V AC OR 28 V DC; 3 AMPS @250 V AC. E3XX MODELS: 5 AMPS @ 125 V AC OR 28 V DC; 2 AMPS @ 250 V AC.
S		MATTE-TIN ⁶		
G	GOLD OVER SILVER ^{2,3}	GOLD ³	LOW LEVEL/DRY CIRCUIT OR POWER	E1XX AND E2XX MODELS: 0.4 VA MAX @20 V AC OR DC MAX. OR 7.5 AMPS @125 V AC OR 28 V DC; 3 AMPS @ 250 V AC. DC E3XX MODELS: 0.4 VA MAX. @ 20 V AC OR DC MAX. OR 5 AMPS @ 125 V AC OR 28 V DC; 2 AMPS @ 250 V AC.
R		MATTE-TIN ⁶		

* Note: See Technical Data section of this catalog for RoHS compliant and compatible definitions and specifications.

¹ CONTACTS & TERMINALS: Copper alloy, with gold plate over nickel plate.

² END CONTACTS: Coin silver, with gold plate over nickel plate.

³ CENTER CONTACTS & ALL TERMINALS: Copper alloy, with gold plate over nickel plate.

⁴ END CONTACTS: Coin silver, silver plated.

⁵ CENTER CONTACT & ALL TERMINALS: Copper alloy, with gold flash over silver plate. Or copper alloy, silver plated.

⁶ TERMINALS: Copper alloy, with matte-tin over nickel plate.

NOTE: Any models supplied with Q, B, G, S P & R contact material are RoHS compliant.

All models with all options when ordered with G, Q, S & R contact material.

B contact material standard with all terminations.

P R & S contact materials not available with Z terminations.

SEAL

E EPOXY SEAL

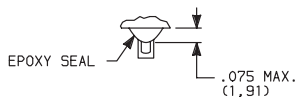

AVAILABLE HARDWARE

J2, J21 Actuators



PART NO.

760502263 BLACK
760503000 RED

Material: Nylon
Finish: Matte

J3 Actuator



PART NO.

766602263 BLACK
766603000 RED

Material: Nylon
Finish: Matte

J1, J11 Actuators



PART NO.

776A02263 BLACK
776A03000 RED

Material: Nylon
Finish: Matte

J50 Actuator

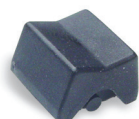

PART NO.

775A02263 BLACK
775A03000 RED

Material: Nylon
Finish: Matte

J60 Actuator



PART NO.

613802263 BLACK
598103000 RED

Material: Nylon
Finish: Matte

J90 Actuator



PART NO.

598002263 BLACK
598003000 RED

Material: Nylon
Finish: Matte

NOTE: Additional nuts, screws and lockwashers available separately, see Technical Data section of this catalog. Other colors available, consult Customer Service Center.

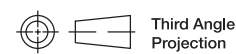

Third Angle
Projection

Dimensions are shown: Inches (mm)
Specifications and dimensions subject to change

C&K



E Series Sealed Miniature Rocker and Lever Handle Switches

AVAILABLE HARDWARE

Fits Z3 Termination female connector



PART NO.
530100000

Available in loose pieces.

Frame for J11, J21 Actuators



PART NO.
764500746 BLACK ENAMEL
764601106 RETAINING SPRING

Material: Spring Steel



J50, J60 & J90 Actuators

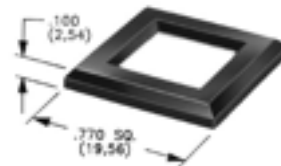

MATTE

PART NO.

486702000

Material: Nylon
Finish: Matte or Gloss

GLOSS

PART NO.

486802000 BLACK

NOTE: Additional nuts, screws and lockwashers available separately, see Technical Data section of this catalog. Other colors available, consult Customer Service Center.

Frames snap into panel opening and are independent from switch mounting. Accurate positioning of the PC mounted switch relative to the panel opening is necessary to provide proper clearance between actuator and frame. Available in two basic styles and four panel thicknesses .047-.125 in. Material: Nylon. Finish: Matte.

TYPICAL APPLICATION

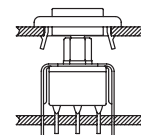

J1 & J2 Actuators

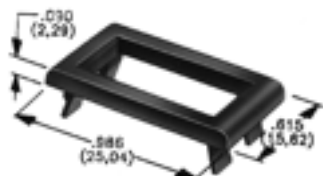

.047" (1,19) PANEL THK. .062" (1,57) PANEL THK. .090" (2,29) PANEL THK. .125" (3,18) PANEL THK.

PART NO.	PART NO.	PART NO.	PART NO.
452902263	452702263	452802263	452602263 BLACK
452903000	452703000	452803000	452603000 RED

J50, J60 & J90 Actuators

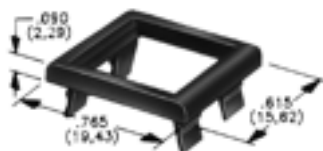

.047" (1,19) PANEL THK. .062" (1,57) PANEL THK. .090" (2,29) PANEL THK. .125" (3,18) PANEL THK.

PART NO.	PART NO.	PART NO.	PART NO.
432502263	432602263	432702263	432802263 BLACK
432503000	432603000	432703000	432803000 RED

PANEL MOUNTING

For part numbers
4529xxxxx, 4527xxxxx,
4528xxxxx, 4526xxxxx

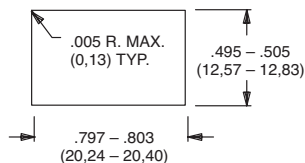

For part numbers
4325xxxxx, 4326xxxxx

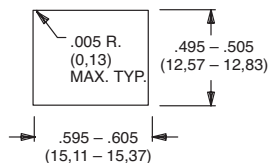

For part numbers
4327xxxxx, 4328xxxxx

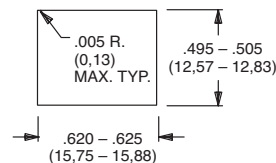

Dimensions are shown: Inches (mm)
Specifications and dimensions subject to change

Rocker

G



E Series Sealed Miniature Rocker and Lever Handle Switches

AVAILABLE HARDWARE

Panel Inserts

Will fit separate snap-in frames for J50, J60, J90 actuators.

Above frames (part nos. 432XXXXXX) are also available with insert which accepts LED for indicator light assembly. Order insert separately from frame. Blank insert panel (without hole for LED) also available. **LED not included.**

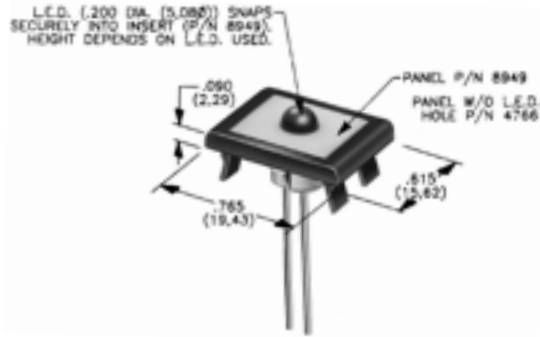

PANEL INSERT
WITH HOLE FOR LED

BLANK PANEL INSERT
WITHOUT HOLE FOR LED

PART NO.

894902000
894903000

PART NO.

476602000 BLACK
476603000 RED

NOTE: Special colors, custom markings available, consult Customer Service Center.

ET Series Sealed Subminiature Rocker Switches

Features/Benefits

- Sealed against solder and cleaning process contaminants
- Rocker, bushing & case—UL 94V-0
- Small footprint—saves space
- RoHS compliant

Typical Applications

- Telecommunications
- Instrumentation
- Computers & peripherals

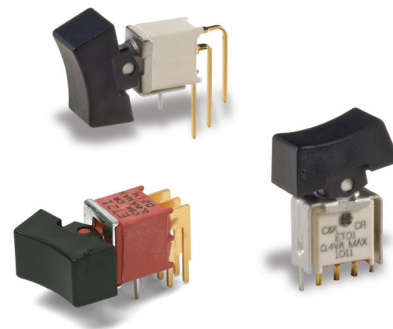

Specifications

CONTACT RATING: B contact material: 0.4 VA max. @ 20 V AC or DC max. Q contact material: Copper alloy, silver plated. See page G-43 for additional ratings.

ELECTRICAL LIFE: ETX1 models: 60,000 make-and-break cycles at full load. All other models: 30,000 cycles.

CONTACT RESISTANCE: Below 20 m Ω typ. initial @ 2-4 V DC, 100 mA, for both silver and gold plated contacts.

INSULATION RESISTANCE: 10⁹ Ω min.

DIELECTRIC STRENGTH: 1000 Vrms min. @ sea level.

OPERATING TEMPERATURE: -30°C to 85°C.

SOLDERABILITY: Per MIL-STD-202F method 208D, or EIA RS-186E method 9 (1 hour steam aging).

PACKAGING: Surface mount switches standard in tape and reel packaging, see page G-45 for drawings and reel information.

Materials

CASE & BUSHING: Glass filled nylon 6/6, flame retardant, heat stabilized (UL 94V-0) or glass filled 4/6 nylon, flame retardant, heat stabilized (UL 94V-0).

ACTUATOR: Nylon, black standard. Internal o-ring seal standard with all actuators. SA surface mount: High temperature material, glass filled 46 nylon, flame retardant, heat stabilized (UL 94V-0).

SWITCH SUPPORT: Brass, matte-tin plated.

CONTACTS & TERMINALS: B contact material: Copper alloy, with gold plate over nickel plate. Q contact material: Copper alloy, silver plated. See page G-43 for additional contact materials.

TERMINAL SEAL: Epoxy.

NOTE: Any models supplied with Q, B, G, S, P & R contact material are RoHS compliant.

NOTE: Specifications and materials listed above are for switches with standard options. For information on specific and custom switches, consult Customer Service Center.

Build-A-Switch

To order, simply select desired option from each category and place in the appropriate box. Available options are shown and described on pages G-40 thru G-44. For additional options not shown in catalog, consult Customer Service Center. All models are process sealed to withstand machine soldering temperatures and pressure wash cleaning methods.

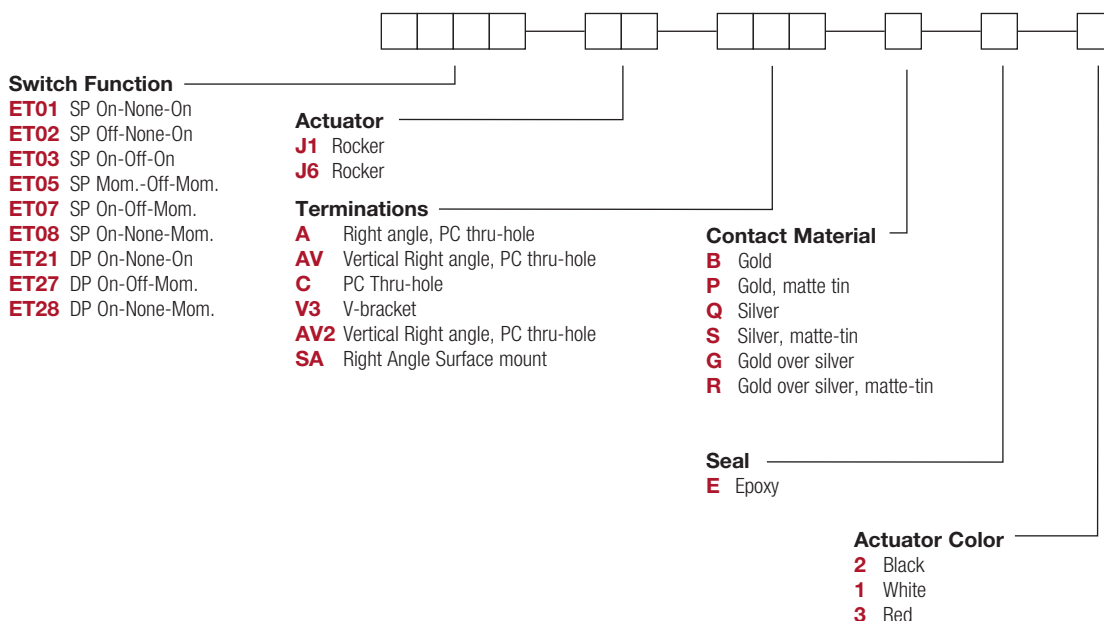

ET Series Sealed Subminiature Rocker Switches

SWITCH FUNCTION

NO. POLES	MODEL NO.	SWITCH FUNCTION			CONNECTED TERMINALS			SCHEMATIC
		POS. 1	POS. 2	POS. 3	POS. 1	POS. 2	POS. 3	
SP	ET01	ON	NONE	ON	2-3	N/A	2-1	
	ET03	ON	OFF	ON		OPEN		
	ET05	MOM.	OFF	MOM.				
	ET07	ON	OFF	MOM.	N/A	SPDT		
	ET08	ON	NONE	MOM.	OPEN	N/A	3-1	
SPDT							ET02 Models: Omit terminal 2 Terminal Nos. For Reference Only	
DP	ET21	ON	NONE	ON	2-3,5-6	N/A	2-1,5-4	
	ET27	ON	OFF	MOM.		OPEN		
	ET28	ON	NONE	MOM.				
DPDT							Terminal Nos. For Reference Only	

MOM. = Momentary

All models with all options when ordered with G, S, R or Q contact material.

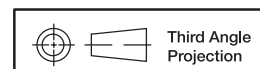

Dimensions are shown: Inches (mm)
Specifications and dimensions subject to change



ET Series Sealed Subminiature Rocker Switches



J1 ROCKER

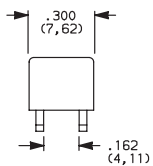
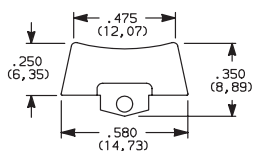

PANEL MOUNTING

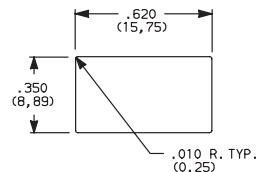

Available with all models except ET0X with A & SA & SA1 terminations.

J6 ROCKER

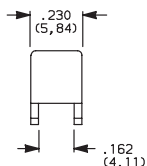
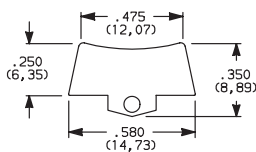

PANEL MOUNTING

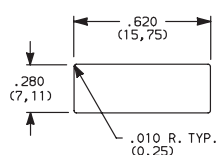

Standard with ET0X model with A & SA & SA1 terminations.

OPTION CODE	ACTUATOR COLOR
2	BLACK
1	WHITE
3	RED

Actuators available separately, see page G-45. Finish: Matte. Other colors, custom actuator markings and legends available, consult Customer Service Center.

NOTE: Internal o-ring actuator seal standard.

TERMINATIONS

C PC THRU-HOLE

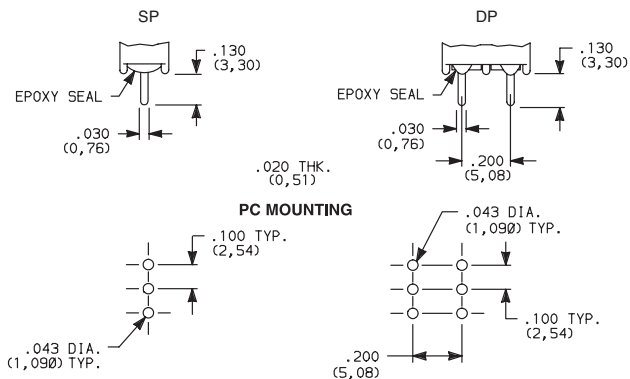

ET02 Models: Omit center hole.

SP & DP

A RIGHT ANGLE, PC THRU-HOLE

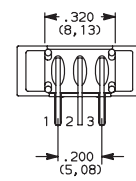
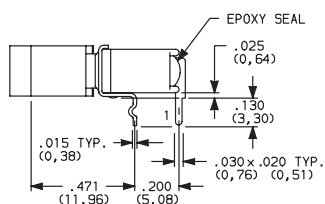
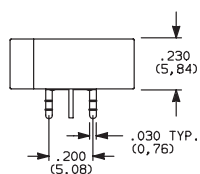

PC MOUNTING

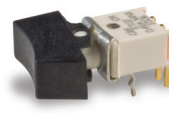
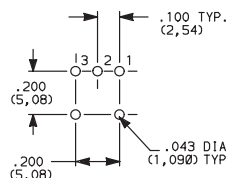

ET01J6ABE2
Horizontal Actuation
SPDT

Actuator Shown In Pos. 1

Not available with ET02 model.

J6 actuator std. only on ET0X models with A terminations.

A RIGHT ANGLE, PC THRU-HOLE

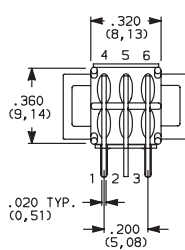
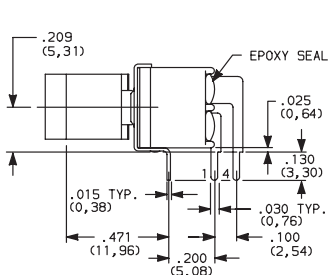
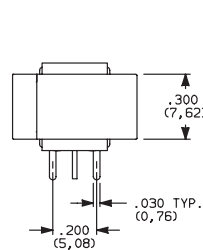

PC MOUNTING

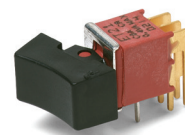
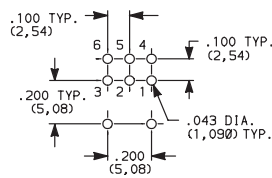

ET21J1ABE2
Horizontal Actuation
DPDT

Actuator Shown In Pos. 1

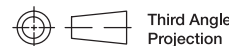

Third Angle
Projection

Dimensions are shown: Inches (mm)
Specifications and dimensions subject to change

Rocker

G



ET Series Sealed Subminiature Rocker Switches

TERMINATIONS

AV VERTICAL RIGHT ANGLE, PC THRU-HOLE

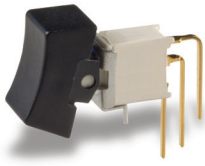

ET01J1AVBE2
Vertical Actuation
SPDT

Actuator Shown In Pos. 1

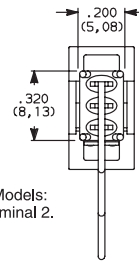
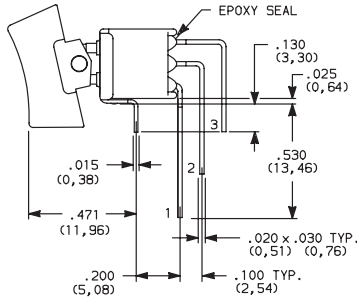
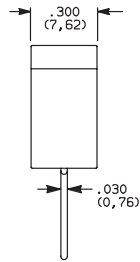

ET02 Models:
Omit terminal 2.

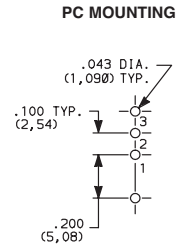

NOTE: Terminal bend radii and lead-in manufacturing option.

AV VERTICAL RIGHT ANGLE, PC THRU-HOLE

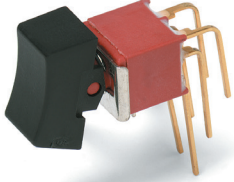

ET21J1AVBE2
Vertical Actuation
DPDT

Actuator Shown In Pos. 1

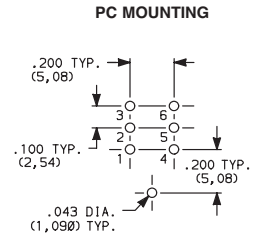
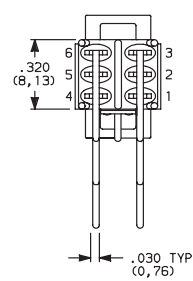
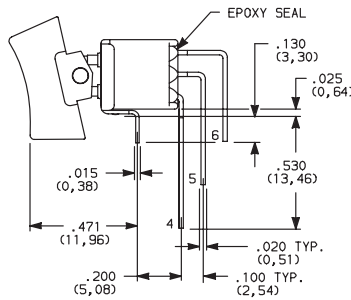
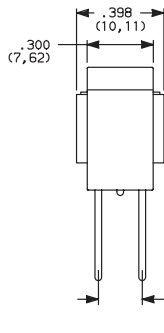

NOTE: Terminal bend radii and lead-in manufacturing option.

AV2 VERTICAL RIGHT ANGLE, PC THRU-HOLE

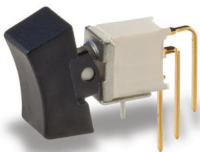

ET01J1AV2BE2
Vertical Actuation
SPDT

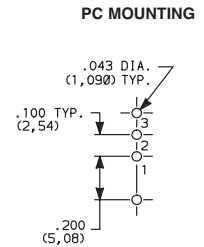
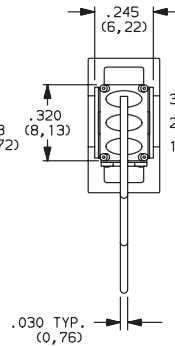
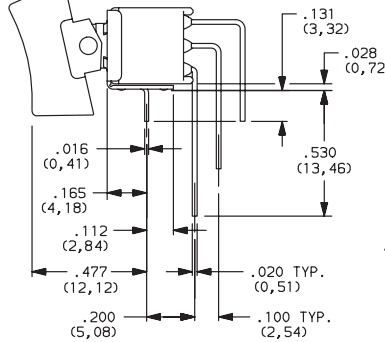
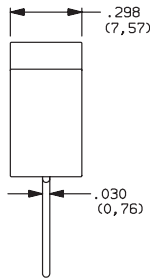

Third Angle
Projection

Dimensions are shown: Inches (mm)
Specifications and dimensions subject to change



ET Series Sealed Subminiature Rocker Switches

TERMINATIONS

SA RIGHT ANGLE, SURFACE MOUNT

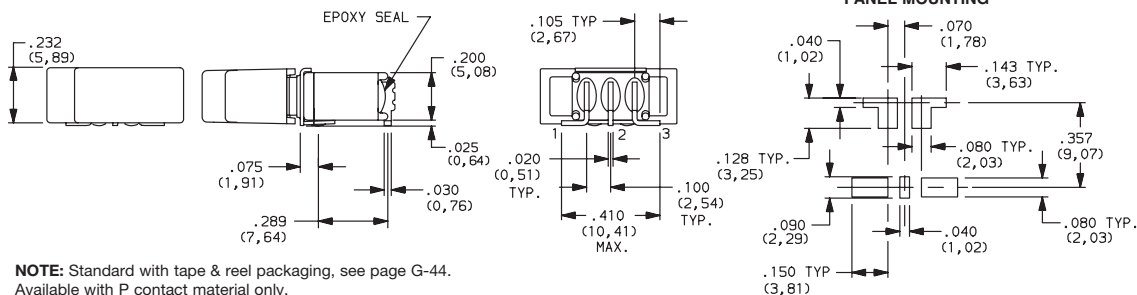

ET01J6SAPE2
Horizontal Actuation
SPDT

V3 VERTICAL MOUNT, V-BRACKET

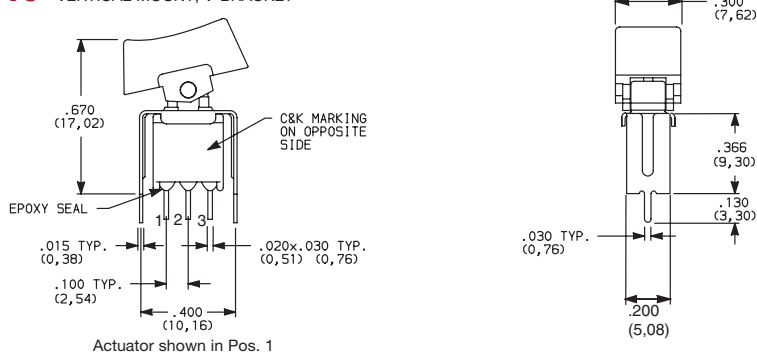

ET01J1V3BE2
SPDT

V3 VERTICAL MOUNT, V-BRACKET

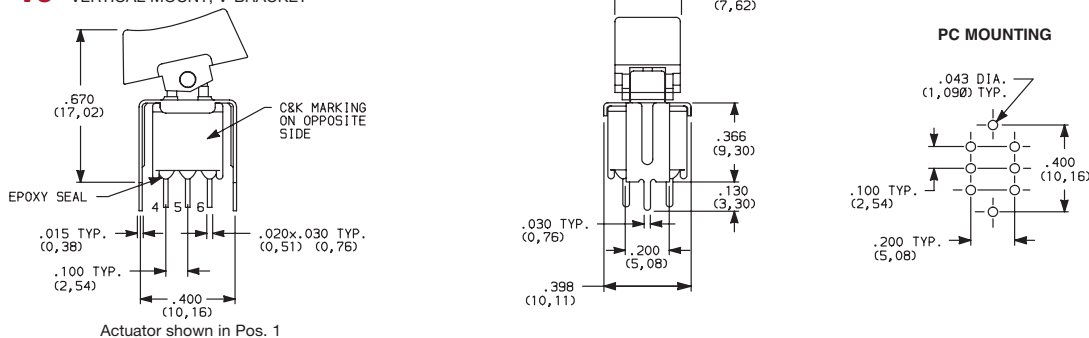

ET21J1V3BE2
DPDT

CONTACT MATERIAL

OPTION CODE	CONTACT MATERIAL	TERMINAL PLATING	RATINGS	
B	GOLD ¹	GOLD ¹	LOW LEVEL/ DRY CIRCUIT	0.4 VA MAX. @ 20 V AC OR DC MAX.
P		MATTE-TIN ⁶		
Q	SILVER ^{4,5}	SILVER ⁵	POWER	ETX1 MODELS: 3 AMPS @ 120 V AC OR 28 V DC. ALL OTHER MODELS: 2 AMPS @ 120 V AC OR 28 V DC.
S		MATTE-TIN ⁶		
G	GOLD OVER SILVER ^{2,3}	GOLD ³	LOW LEVEL/DRY CIRCUIT OR POWER	ETX1 MODELS: 0.4 VA MAX @ 20 V AC OR DC MAX. OR 3 AMPS @ 120 V AC OR 28 V DC. ALL OTHER MODELS: 0.4 VA MAX @ 20 V AC OR DC MAX. OR 2 AMPS @ 120 V AC OR 28 V DC.
R		MATTE-TIN ⁶		

* Note: See Technical Data section of this catalog for RoHS compliant and compatible definitions and specifications.

¹ CONTACTS & TERMINALS: Copper alloy, with gold plate over nickel plate.

² END CONTACTS: Coin silver, with gold plate over nickel plate.

³ CENTER CONTACTS & ALL TERMINALS: Copper alloy, with gold plate over nickel plate.

⁴ END CONTACTS: Coin silver, silver plated.

⁵ CENTER CONTACT & ALL TERMINALS: Copper alloy, silver plated.

⁶ TERMINALS: Copper alloy, with matte-tin over nickel plate.

NOTE: Any models supplied with Q, B, G, S, P & R contact material are RoHS compliant.

All models with all options when ordered with G, Q, S & R contact material.



Dimensions are shown: Inches (mm)
Specifications and dimensions subject to change

ET Series Sealed Subminiature Rocker Switches

SEAL



E EPOXY SEAL

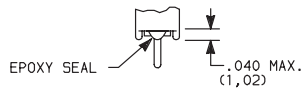

AVAILABLE HARDWARE

J1 Actuator



PART NO.

261A01000 WHITE
261A02263 BLACK
261A03000 RED

Material: Nylon
Finish: Matte

NOT AVAILABLE WITH A, SA,
SA1

J6 Actuator



PART NO.

621C01000 WHITE
621C02263 BLACK
621C03000 RED

Material: Nylon
Finish: Matte

For Hi Temp, Consult Factory

NOTE: Other colors available,
consult Customer Service Center.

TAPE & REEL SA TERMINATION

ET01J6SABE (SHOWN)

REEL INFORMATION	
OUTSIDE DIAMETER	13.00 (330,0)
PILOT HOLE	.512 (13,0)
QUANTITY PER REEL	500

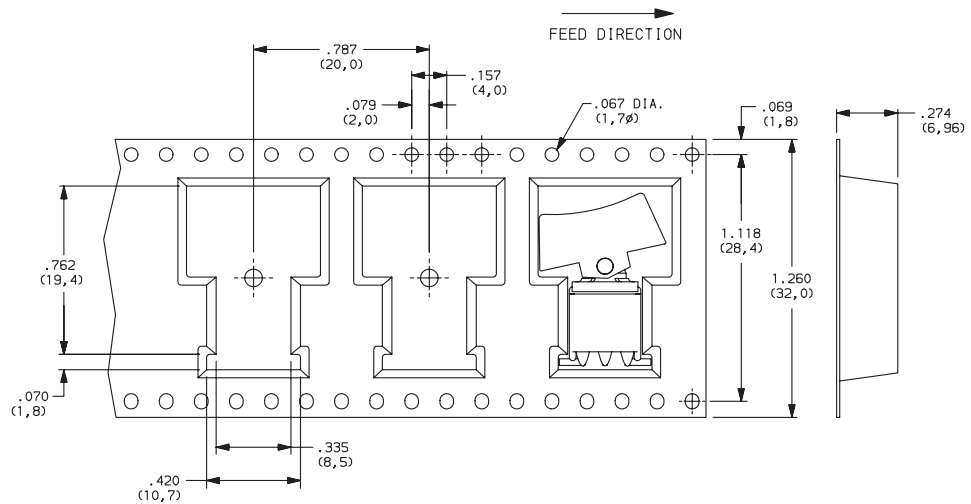

ET01J6SA1BE (SHOWN)

REEL INFORMATION	
OUTSIDE DIAMETER	13.00 (330,0)
PILOT HOLE	.795 (20,20)
QUANTITY PER REEL	450

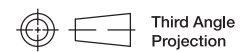
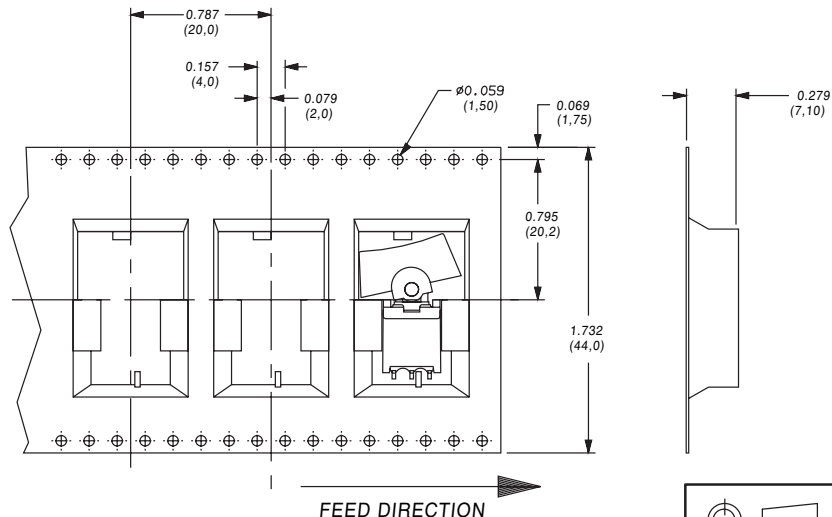

Dimensions are shown: Inches (mm)
Specifications and dimensions subject to change



T Series Subminiature Rocker Switches

Features/Benefits

- Compact size—small footprint
- Single and double pole models
- PC and panel mounting options available
- RoHS compliant

Typical Applications

- Telecommunications
- Instrumentation
- Medical Equipment

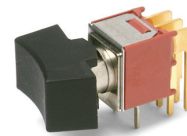
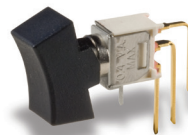

Models Available

Specifications

CONTACT RATING: Q contact material (TX01 models): 3 AMPS @ 120 V AC or 28 V DC. All other models: 2 AMPS @ 120 V AC or 28 V DC. See page G-49 for additional ratings.

ELECTRICAL LIFE: TX01 models: 60,000 make-and-break cycles at full load. All other models: 30,000 cycles.

CONTACT RESISTANCE: Below 20 m Ω typ. initial @ 2–4 V DC, 100 mA, for both silver and gold plated contacts.

INSULATION RESISTANCE: 10⁹ Ω min.

DIELECTRIC STRENGTH: 1000 Vrms min. @ sea level.

OPERATING TEMPERATURE: –30°C to 85°C.

SOLDERABILITY: Per MIL-STD-202F method 208D, or EIA RS-186E method 9 (1 hour steam aging).

NOTE: Any models supplied with B, G, P, Q or R contact material are RoHS compliant.

NOTE: Specifications and materials listed above are for switches with standard options. For information on specific and custom switches, consult Customer Service Center.

Materials

CASE: Glass filled nylon 6/6, flame retardant, heat stabilized or diallyl phthalate (DAP), (UL 94V-0) or glass filled nylon 4/6, flame retardant, heat stabilized.

ACTUATOR: Nylon, black standard.

BUSHING: Brass, nickel plated.

HOUSING: Stainless steel.

SWITCH SUPPORT: Brass, matte-tin plated.

MOUNTING BRACKET: Stainless steel.

END CONTACTS: B contact material: Copper alloy, with gold plate over nickel plate. Q contact material: Coin silver, silver plated. See page G-49 for additional contact materials.

CENTER CONTACTS & TERMINALS: B contact material: Copper alloy, with gold plate over nickel plate. Q contact material: Copper alloy, silver plated. See page G-49 for additional contact materials.

TERMINAL SEAL: Epoxy.

HARDWARE: Nut, Screws & Lockwasher: Stainless steel.
Standoff: Nylon standard.

Build-A-Switch

To order, simply select desired option from each category and place in the appropriate box. Available options are shown and described on pages G-46 through G-50. For additional options not shown in catalog, consult Customer Service Center. All models have epoxy terminal seal and are compatible with all “bottom-wash” PCB cleaning methods.

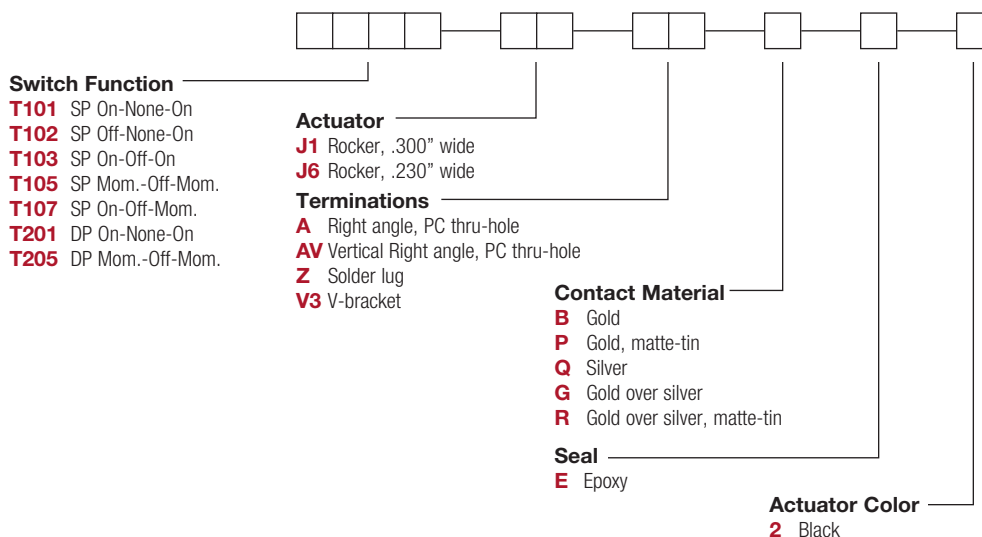

T Series Subminiature Rocker Switches

ACTUATOR COLOR

SWITCH FUNCTION



NO. POLES	MODEL NO.	SWITCH FUNCTION			CONNECTED TERMINALS			SCHEMATIC
		POS. 1	POS. 2	POS. 3	POS. 1	POS. 2	POS. 3	
		C&K marking on opposite side			C&K marking on opposite side			
SP	T101	ON	NONE	ON	2-3	N/A	2-1	
	T103	ON	OFF	ON		OPEN		
	T105	MOM.	OFF	MOM.				
	T107	ON	OFF	MOM.				
	T102	OFF	NONE	ON	OPEN	N/A	3-1	

SPDT

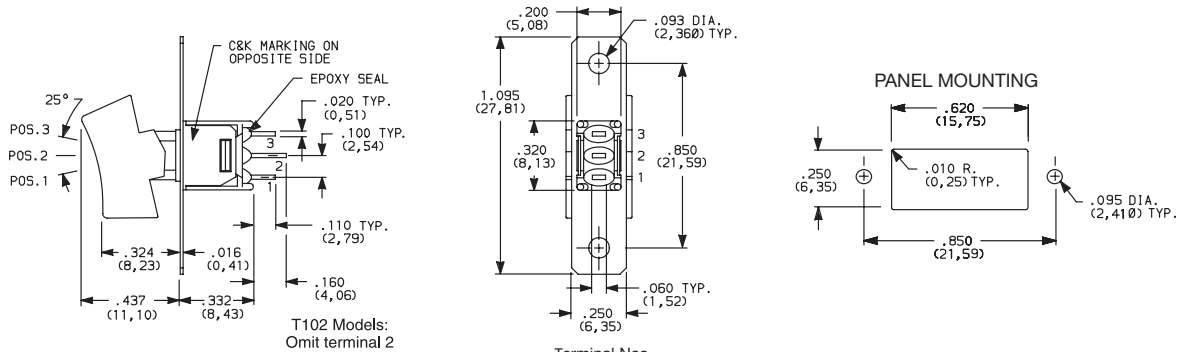

DP	T201	ON	NONE	ON	2-3,5-6	N/A	2-1,5-4	
	T205	MOM.	OFF	MOM.		OPEN		

DPDT

DPDT

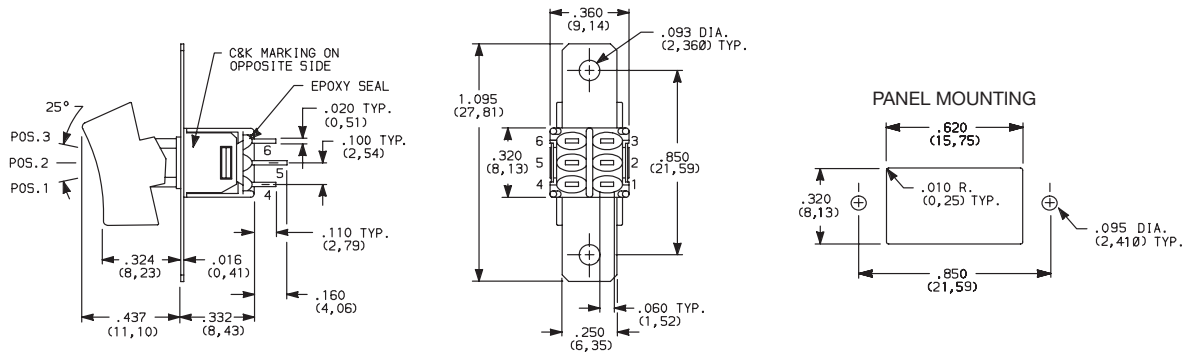

MOM. = Momentary

All models with all options when ordered with G, Q or R contact material.

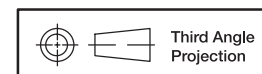

Dimensions are shown: Inches (mm)
Specifications and dimensions subject to change



T Series Subminiature Rocker Switches

ACTUATOR

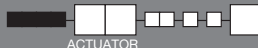

J1 ROCKER, .300 WIDE

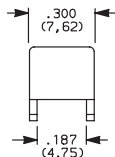
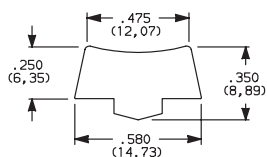

PANEL MOUNTING

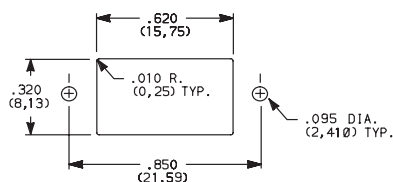

Standard with all models except T10X with A terminations.

J6 ROCKER, .230 WIDE

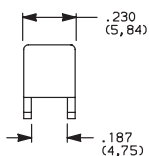
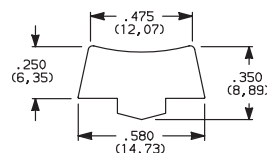

PANEL MOUNTING

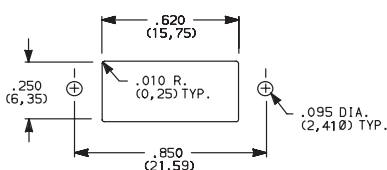

Standard with T10X model with A terminations.

OPTION CODE	ACTUATOR COLOR
2	BLACK

Actuators available separately, see page G 50. Finish: Matte. Other colors, custom actuator markings and legends available, consult Customer Service Center.

TERMINATIONS



Z SOLDER LUG

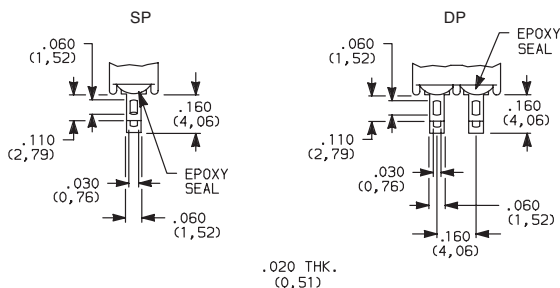

SP and DP

Not available with P or R contact material.

A RIGHT ANGLE, PC THRU-HOLE

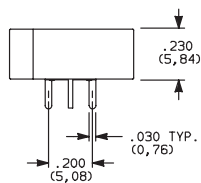

Actuator Shown In Pos. 1

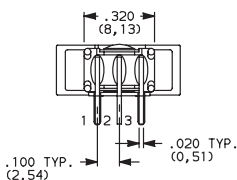
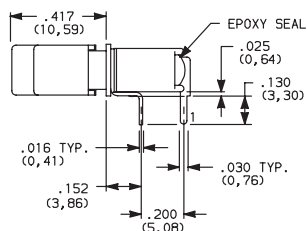

PC MOUNTING

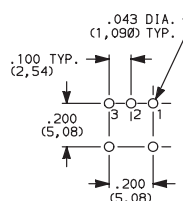

T101J6ABE2
Horizontal Actuation
SPDT

Not available with T102 model. J6 actuator standard only on T10X models with A terminations.



Dimensions are shown: Inches (mm)

Specifications and dimensions subject to change

T Series Subminiature Rocker Switches

TERMINATIONS

A RIGHT ANGLE, PC THRU-HOLE

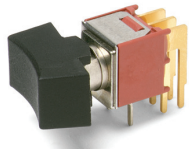

T201J1ABE2
Horizontal Actuation
DPDT

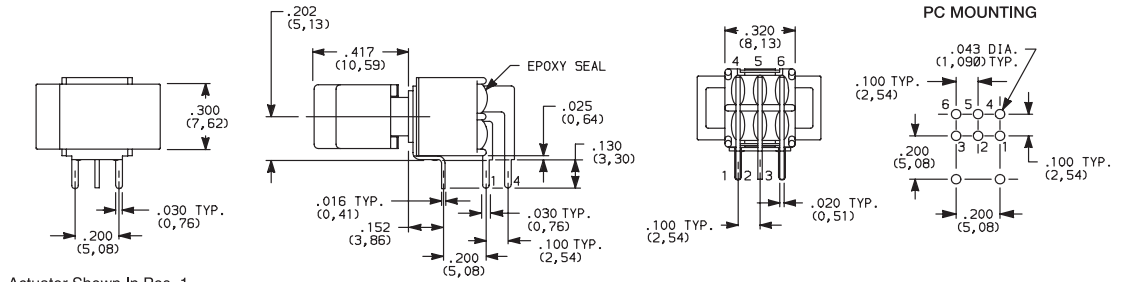

AV VERTICAL RIGHT ANGLE, PC THRU-HOLE

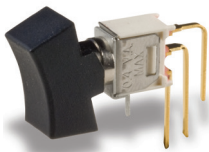

T101J1AVBE2
Vertical Actuation
SPDT

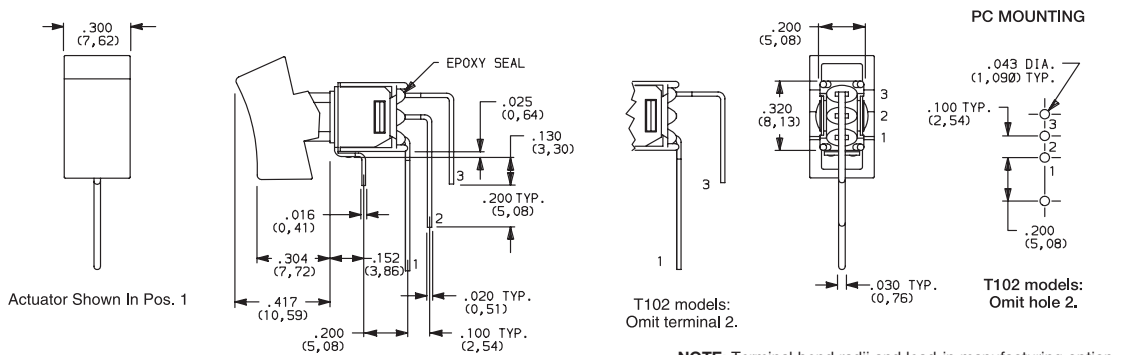

NOTE: Terminal bend radii and lead-in manufacturing option.

AV VERTICAL RIGHT ANGLE, PC THRU-HOLE

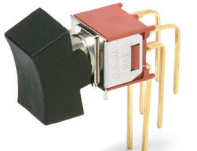

T201J1AVBE2
Vertical Actuation
DPDT

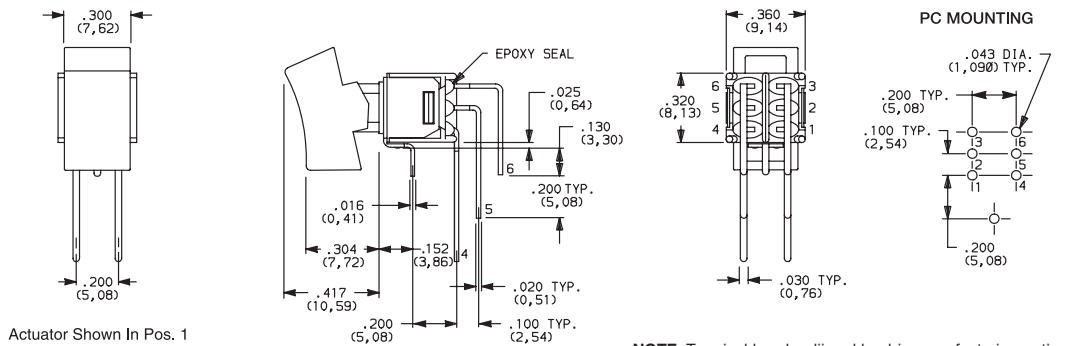

NOTE: Terminal bend radii and lead-in manufacturing option.

V3 VERTICAL MOUNT, V-BRACKET



T101J1V3BE2
SPDT

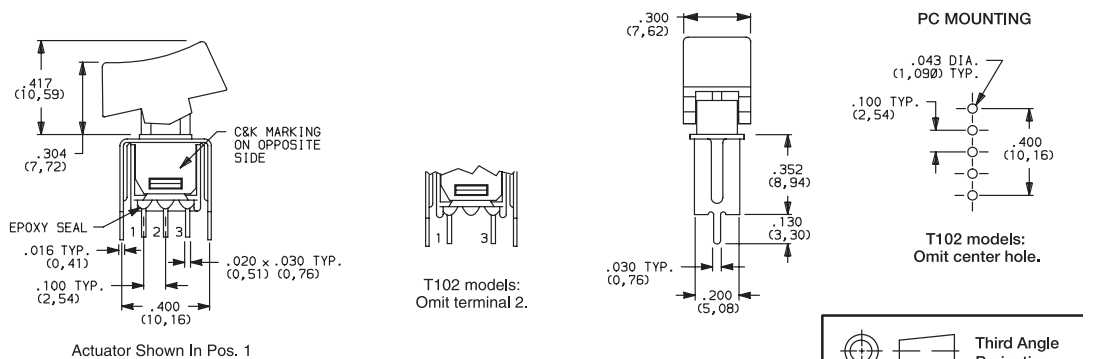

Dimensions are shown: Inches (mm)
Specifications and dimensions subject to change



T Series Subminiature Rocker Switches

TERMINATIONS

V3 VERTICAL MOUNT, V-BRACKET

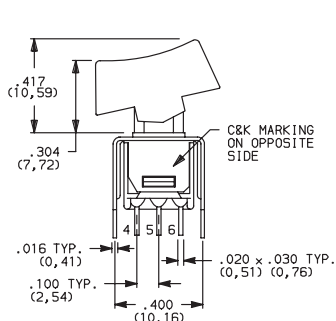

Actuator Shown In Pos. 1

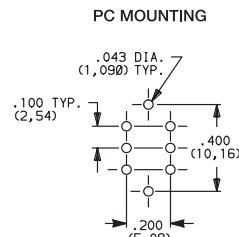
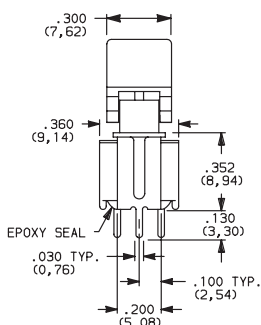

T201J1V3BE2
DPDT

CONTACT MATERIAL

OPTION CODE	CONTACT MATERIAL	TERMINAL PLATING	RATINGS	
B	GOLD ³	GOLD ¹	LOW LEVEL/ DRY CIRCUIT	0.4 VA MAX. @ 20 V AC OR DC MAX.
P		MATTE-TIN ⁶		
Q	SILVER ^{4,5}	SILVER ⁵	POWER	TX01 MODELS: 3 AMPS @ 120 V AC OR 28 V DC. ALL OTHER MODELS: 2 AMPS @ 120 V AC OR 28 V DC.
G	GOLD OVER SILVER ^{2,3}	GOLD ³	LOW LEVEL/DRY CIRCUIT OR POWER	TX01 MODELS: 0.4 VA MAX @ 20 V AC OR DC MAX. OR 3 AMPS @ 120 V AC OR 28 V DC. ALL OTHER MODELS: 0.4 VA MAX @ 20 V AC OR DC MAX. OR 2 AMPS @ 120 V AC OR 28 V DC.
R		MATTE-TIN ⁶		

* Note: See Technical Data section of this catalog for RoHS compliant and compatible definitions and specifications.

- 1 CONTACTS & TERMINALS: Copper alloy, with gold plate over nickel plate.
- 2 END CONTACTS: Coin silver, with gold plate over nickel plate.
- 3 CENTER CONTACTS & ALL TERMINALS: Copper alloy, with gold plate over nickel plate.
- 4 END CONTACTS: Coin silver, silver plated.
- 5 CENTER CONTACT & ALL TERMINALS: Copper alloy, silver plated.
- 6 TERMINALS: Copper alloy, with matte-tin over nickel plate.

NOTE: Any models supplied with B, G, P, Q & R contact material are RoHS compliant.

All models with all options when ordered with G, Q, or R contact material.

B contact material standard with A, AV, V3 terminations.

Q contact material standard with C & Z terminations.

P & R contact materials not available with Z terminations.

SEAL

E EPOXY SEAL

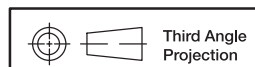
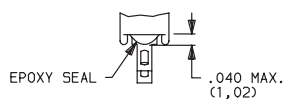

T Series Subminiature Rocker Switches

AVAILABLE HARDWARE

Panel mounting hardware for rocker and lever handle switches is available separately. Mounting hardware consists of two screws, two nuts, two standoffs and two lockwashers per switch, and is available for panel thicknesses of 1/16, 3/32 and 1/8 inch. See part numbers below.

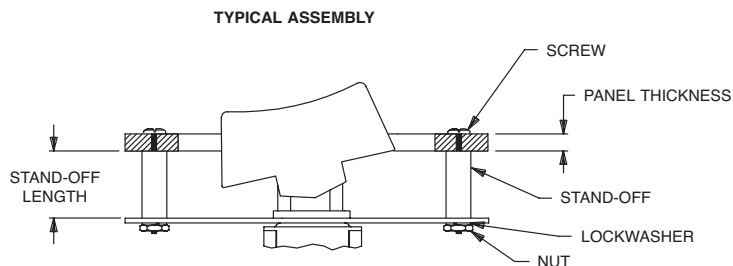

PART NO.	PANEL THK.	STANDOFF LENGTH
761101000	1/16 IN. (1,59)	.295 (7,49)
761102000	3/32 IN. (2,38)	.264 (6,71)
761103000	1/8 IN. (3,18)	.233 (5,92)

NOTE: Additional nuts, screws and lockwashers available separately, see Technical Data section of this catalog.

J1 Actuator



PART NO.
468002263 BLACK

Material: Nylon
Finish: Matte

J6 Actuator



PART NO.
468102263 BLACK

Material: Nylon
Finish: Matte

NOTE: Other colors, custom actuator markings and legends available, consult Customer Service Center.

9000 Series Power Rocker and Lever Handle Switches

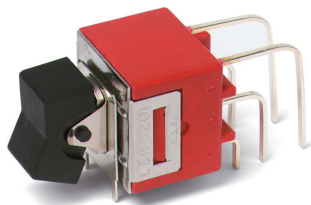

Features/Benefits

- *Thermoset UL 94V-0 housing*
- *Rugged construction*
- *Variety of actuator and termination options*
- *RoHS compliant*

Typical Applications

- *Small equipment*
- *Shut-off switch*

UL 61058-1



Specifications

CONTACT RATING:

9201 Model:

- GP (general purpose)
- 6 AMPS 125 VAC 50/60 Hz T85 10,000 cycles (10E3)
- 3 AMPS 250 VAC 50/60 Hz T85 10,000 cycles
- R (resistive)
- 6 AMPS 30 VDC T85 10,000 cycles

9221 Model:

- GP (general purpose)
- 10 AMPS 125 VAC 50/60 Hz T85 10,000 cycles
- 5 AMPS 250 VAC 50/60 Hz T85 10,000 cycles
- R (resistive)
- 10 AMPS 30 VDC T85 10,000 cycles

ELECTRICAL LIFE: 25,000 make-and-break cycles at full load.

CONTACT RESISTANCE: Below 10 m Ω typ. initial @ 2–4 V DC, 100 mA.

INSULATION RESISTANCE: 10⁹ Ω min.

DIELECTRIC STRENGTH: 2,500 Vrms min. @ sea level.

OPERATING TEMPERATURE: –30°C to 85°C.

SOLDERABILITY: Per MIL-STD-202F method 208D, or EIA RS-186E method 9 (1 hour steam aging).

Materials

CASE: Diallyl phthalate (DAP) (UL 94V-0).

ACTUATOR: Nylon, black standard.

FRAME-REAR MOUNT OPTIONS: Spring steel, black.

BUSHING: Brass, nickel plated.

HOUSING: Stainless steel.

SWITCH SUPPORT: Brass or steel, matte-tin plated.

MOUNTING BRACKET: Stainless steel.

END CONTACTS: 9201 Model: Coin silver, silver plated.
9221 Model: Silver cadmium oxide.

CENTER CONTACTS: Copper alloy, silver plated

ALL TERMINALS: 9201 Model: Copper alloy, silver plated.
9221 Model: Copper alloy, matte-tin plated.

TERMINAL SEAL: Epoxy.

HARDWARE: Nut, Screw & Lockwasher: Stainless steel. Standoff: Nylon standard, aluminum available, consult Customer Service Center.

*Cadmium used in electrical contacts is acceptable for RoHS.

NOTE: Any models supplied with Q contact material are RoHS compliant.

NOTE: Specifications and materials listed above are for switches with standard options. For information on specific and custom switches, consult Customer Service Center.

Build-A-Switch

To order, simply select desired option from each category and place in the appropriate box. Available options are shown and described on pages G-52 through G-55. For additional options not shown in catalog, consult Customer Service Center.



Switch Function

- 9201** DP On-On, 6 Amps
- 9221** DP On-On, 10 Amps

Actuator

- J1** Rocker
- J2** Lever
- J3** Rocker
- J37** Rocker with metal frame

Terminations

- Z** Solder lug (9201 only)
- AV2** Vertical right angle, PC thru-hole (9201 only)
- C** PC Thru-hole (9201 only)
- Z4** Quick connect

Contact Material

- Q** Silver

Seal

- E** Epoxy
- D** No Seal

Actuator Color

- 2** Black
- 1** White
- 3** Red

Frame Color

- 2** Black
- NONE** No frame color required

Rocker



G



Dimensions are shown: Inches (mm)

Specifications and dimensions subject to change

9000 Series Power Rocker and Lever Handle Switches

SWITCH FUNCTION

NO. POLES	MODEL NO.	RATING*	SWITCH FUNCTION		CONNECTED TERMINALS		SCHEMATIC
			POS. 1	POS. 2	POS. 1	POS. 2	
DP	9201	6 AMPS	ON	ON	2-3,5-6	2-1,5-4	 DPDT
	9221	10 AMPS	ON	ON			

DPDT

Part number shown: 9201J1ZQE2

Terminal Nos. Molded On Side Of Case

All 9000 Series models meet international dimensional and electrical requirements.



* See CONTACT MATERIAL, page G-54, for complete ratings.

9221 model must be ordered with Z4 terminations and D seal option.

ACTUATOR-PANEL MOUNT

OPTION CODE	ACTUATOR COLOR
2	BLACK
1	WHITE
3	RED

Finish: Matte. Other colors, custom actuator markings and legends available, consult Customer Service Center.

NOTE: Hardware: two each—mounting screws, nuts, lockwashers and standoffs for 1/8 inch thick panel are supplied standard on all switches with panel mounting brackets. Actuators available separately, see page G-55. Hardware available separately, see Technical Data section of this catalog.

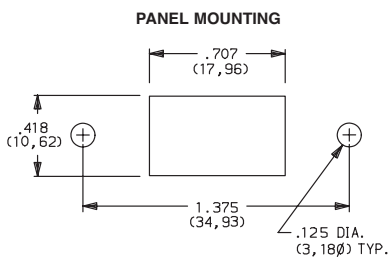

J1 ROCKER

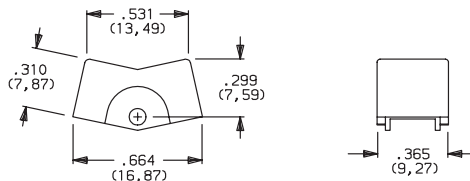

J2 LEVER

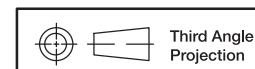
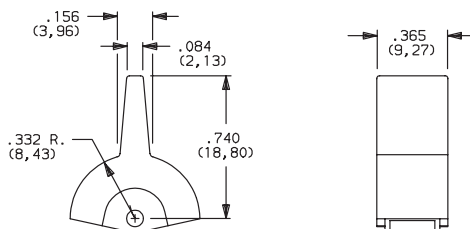

Dimensions are shown: Inches (mm)
Specifications and dimensions subject to change



9000 Series Power Rocker and Lever Handle Switches

ACTUATOR-PANEL MOUNT

ACTUATOR COLOR

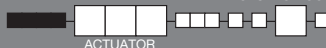

J3 ROCKER

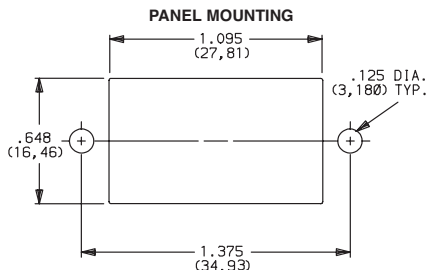
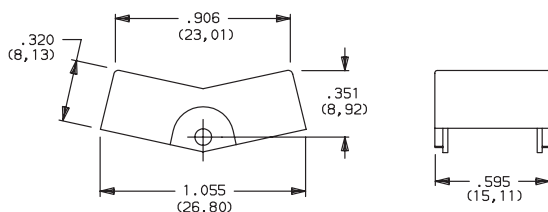

OPTION CODE	ACTUATOR COLOR
2	BLACK
1	WHITE
3	RED

Actuator finish: Matte. Other colors, custom actuator markings and legends available, consult Customer Service Center.

NOTE: Actuators available separately, see page G-55. Hardware: two each—mounting screws, nuts, lockwashers and standoffs for 1/8 inch thick panel are supplied standard on all switches with panel mounting brackets. Hardware available separately, see Technical Data section of this catalog.

ACTUATOR-REAR MOUNT

ACTUATOR COLOR



J37 ROCKER WITH METAL FRAME

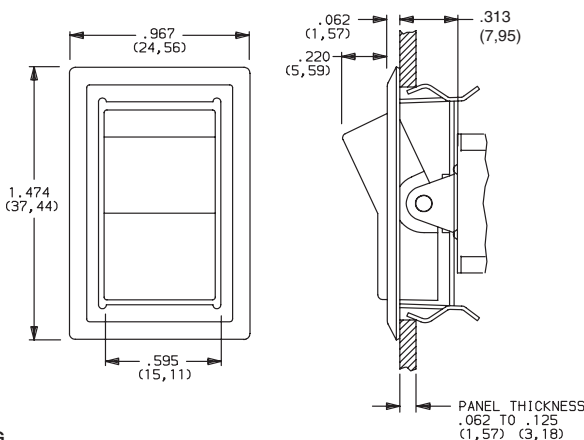
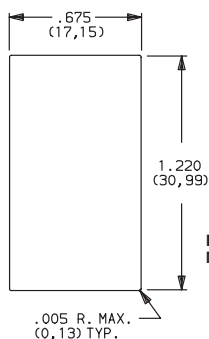

Not available with AV2 termination.

OPTION CODE	ACTUATOR COLOR
2	BLACK
1	WHITE
3	RED

OPTION CODE	FRAME COLOR
2	BLACK

Actuator finish: Matte. Frame finish: Gloss. Other colors, custom actuator markings and legends available, consult Customer Service Center.

NOTE: Actuators & frames available separately, see page G-55. Hardware: two each—mounting screws, nuts, lockwashers and standoffs for 1/8 inch thick panel are supplied standard on all switches with panel mounting brackets. Hardware available separately, see Technical Data section of this catalog.

TERMINATIONS

Z SOLDER LUG

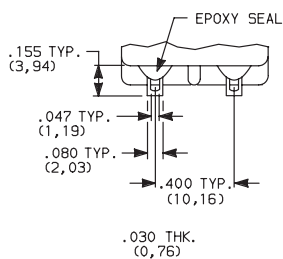

9201 Only

C PC THRU-HOLE

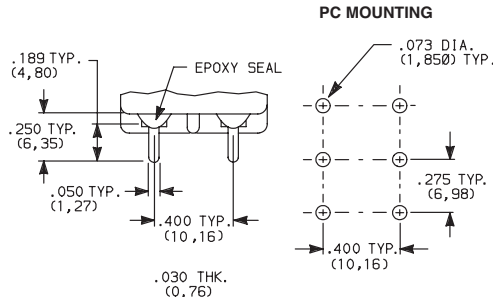

9201 Only

Z4 QUICK CONNECT

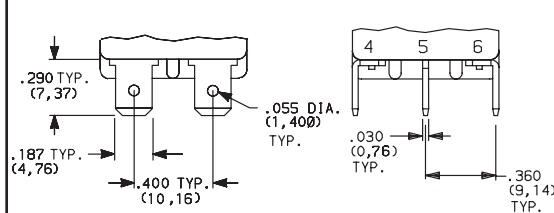

9201 and 9221

NOTE: Only termination available with 9221 model. Must be ordered with D seal option. Mating terminal standard Nema .187" quick connect.



Dimensions are shown: Inches (mm)
Specifications and dimensions subject to change

Rocker

G

C&K

9000 Series Power Rocker and Lever Handle Switches

TERMINATIONS

AV2 VERTICAL RIGHT ANGLE, PC THRU-HOLE

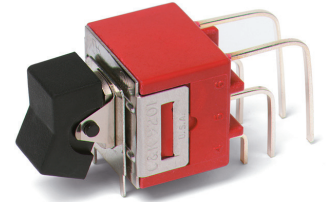
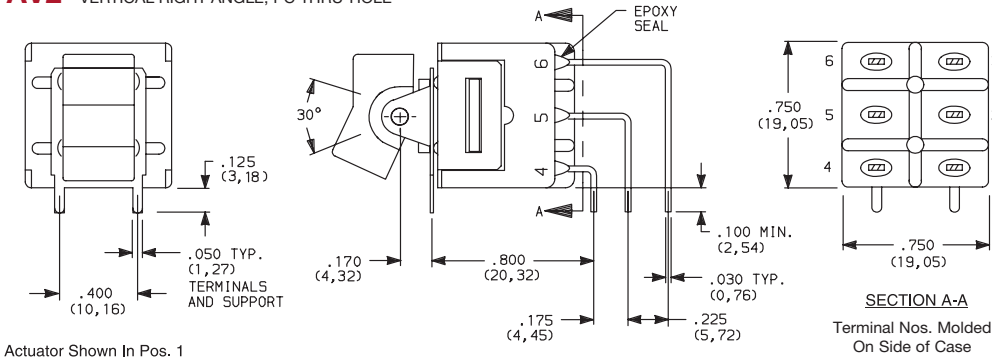

9201J1AV2QE2
Vertical Actuation
DPDT

PC MOUNTING

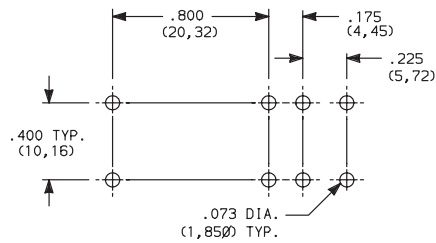

9201 Only

NOTE: Terminal bend radii and lead-in manufacturing option.
Terminal spacing greater than 3mm at all points.

CONTACT MATERIAL

OPTION CODE	MODEL	CONTACT MATERIAL	TERMINAL PLATING	RATINGS
Q	9201	SILVER 1,2	SILVER OR TIN 2,5	GP (general purpose) 6 AMPS 125 VAC 50/60 Hz T85 10,000 cycles (10E3) 3 AMPS 250 VAC 50/60 Hz T85 10,000 cycles R (resistive) 6 AMPS 30 VDC T85 10,000 cycles
	9221	SILVER CADMIUM OXIDE 3,4,6	TIN 5	GP (general purpose) 10 AMPS 125 VAC 50/60 Hz T85 10,000 cycles 5 AMPS 250 VAC 50/60 Hz T85 10,000 cycles R (resistive) 10 AMPS 30 VDC T85 10,000 cycles

* Note: See Technical Data section of this catalog for RoHS compliant and compatible definitions and specifications.

- 1 END CONTACTS: Coin silver, silver plated.
- 2 CENTER CONTACTS & ALL TERMINALS: Copper alloy, silver plated.
- 3 END CONTACTS: Silver cadmium oxide.
- 4 CENTER CONTACTS: Copper alloy, silver plated.
- 5 Z4 TERMINALS ONLY: Copper alloy, tin plated.
- 6 Cadmium used for electrical contacts is acceptable for RoHS.

NOTE: Any models supplied with Q contact material is RoHS compliant.

9221 model must be ordered with Z4 terminations and D seal option.

All 9000 Series models meet international dimensional and electrical requirements.



SEAL

E EPOXY SEAL

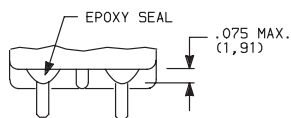

Not available with 9221 model or Z4 terminations.

D NO EPOXY SEAL

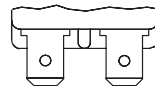

Must be ordered with 9221 model and Z4 termination.



Dimensions are shown: Inches (mm)
Specifications and dimensions subject to change



9000 Series Power Rocker and Lever Handle Switches

AVAILABLE HARDWARE

Panel mounting hardware for rocker and lever handle switches is available separately. Mounting hardware consists of two screws, two nuts, two standoffs and two lockwashers per switch, and is available for panel thicknesses of 1/16, 3/32 and 1/8 inch. See part numbers below.

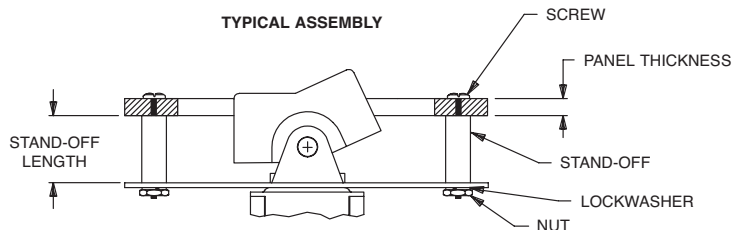

J1 & J2 actuators

PART NO.	PANEL THK.	STANDOFF LENGTH
761101000	1/16 IN. (1,59)	.295 (7,49)
761102000	3/32 IN. (2,38)	.264 (6,71)
761103000	1/8 IN. (3,18)	.233 (5,92)

J1 Actuator



PART NO.
776A01000 WHITE
776A02263 BLACK
776A03000 RED

Material: Nylon
 Finish: Matte

J2 Actuator



PART NO.
760501000 WHITE
760502263 BLACK
760503000 RED

Material: Nylon
 Finish: Matte

J3, J37 Actuators



PART NO.
766601000 WHITE
766602263 BLACK
766603000 RED

Material: Nylon
 Finish: Matte

Frame for J37 Actuators



PART NO.
445400746 BLACK ENAMEL
 Material: Spring Steel

NOTE: Additional nuts, screws and lockwashers available separately, see Technical Data section of this catalog.

Other colors available, consult Customer Service Center.

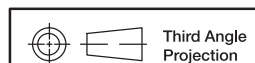

DA Series Miniature Single Pole Rocker Switches

Features/Benefits

- Nice actuator styling with multiple options
- Guards to prevent accidental actuation
- Momentary and maintained functions
- IP54 splash proof rubber boot option
- RoHS compliant

Typical Applications

- Small appliances
- Computers and peripherals
- Medical instrumentation



UL **61058-1**

Specifications

CONTACT RATING:

- 16 AMPS @ 125 VAC, 1/3 HP;
- 10 AMPS @ 250 VAC, 1/2 HP.
- 10 AMPS @ 125 VAC, 6 AMPS @ 250 VAC.

ELECTRICAL LIFE: 10,000 make and break cycles at full load.

INSULATION RESISTANCE: $10^8 \Omega$ min.

DIELECTRIC STRENGTH: 1,500 VRMS @ sea level.

OPERATING TEMPERATURE: -20°C to +85°C

Materials

HOUSING AND ACTUATOR: 6/6 nylon (UL94V-2), black, matte finish.

ILLUMINATED ACTUATOR: Polycarbonate, matte finish.

CENTER CONTACTS: Silver plated, copper alloy.

END CONTACTS: Silver plated.

ALL TERMINALS: Silver plated, copper alloy.

NOTE: Specifications and materials listed above are for switches with standard options. For information on specific and custom switches, consult Customer Service Center.

Build-A-Switch

To order, simply select desired option from each category and place in the appropriate box. Available options are shown and described on pages G-57 through G-60. For additional options not shown in catalog, consult Customer Service Center.

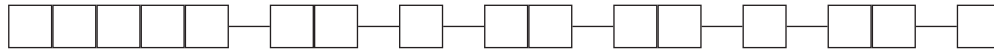

Switch Function

- DA101** SPDT On-None-On
- DA102** SPST On-None-Off
- DA103** SPDT On-Off-On

Actuator

- J1** Rocker
- J2** Two-tone rocker
- *, **J3** Illuminated rocker
- ** J4** Circle, illuminated rocker
- ** J5** Oval, illuminated rocker

Actuator Color

- 1-5** See Chart on Page G-59
- *R** Red, illuminated
- *A** Amber, illuminated
- *G** Green, illuminated

* Actuator "J3" illuminated switches are not available with actuator markings

** Actuator "J3", "J4" and "J5" are not available with Termination option "17" solder lug

Mounting Style/Color

- S2** Snap-in, black
- S1** Snap-in, white
- B2** Recessed snap-in bracket, black
- G2** Guard, black

Termination

- 15** .187" quick connect
- 17** Solder lug
- 02** Thru-hole
- A** Right angle

Actuator Marking

- (NONE)** No marking
- D** ON-OFF
- H** "O I" - international ON-OFF
- N** Large dot
- P** "O -" international ON-OFF

Contact Rating

- QF** Silver

Lamp Rating

- (NONE)** No lamp
- 6** LED
- 7** 125 VAC neon
- 8** 250 VAC neon



15 May 20

Dimensions are shown: Inches (mm)
Specifications and dimensions subject to change



DA Series Miniature Single Pole Rocker Switches

SWITCH FUNCTION

NO. POLES	MODEL NO.	SWITCH FUNCTION			CONNECTED TERMINALS			SCHEMATIC
		C&K marking on opposite side			C&K marking on opposite side			
SP	DA101	ON	NONE	ON	2-3	N/A	2-1	
	DA102	ON	NONE	OFF				 OR For 7 & 8 Illuminated Versions Only
	DA103	ON	OFF	ON				 OR For 6 Illuminated Versions Only

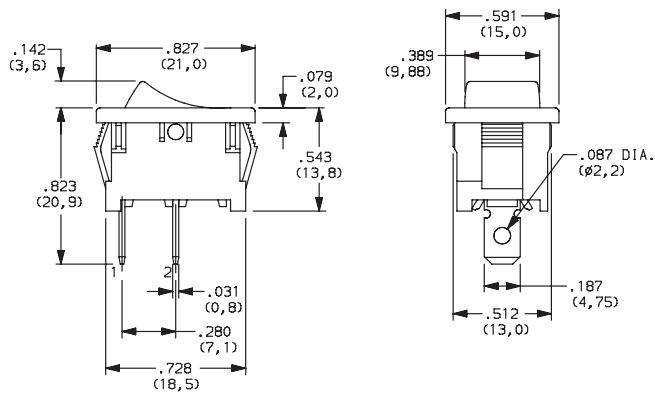

Shown in Pos. 1

ACTUATOR

- J1** ROCKER
- *J3** ILLUMINATED ROCKER

- J2** TWO-TONE ROCKER

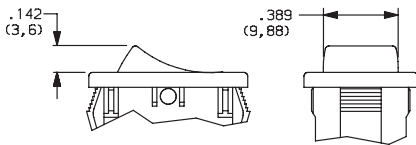

NOTE: J3 actuator available with DA102 switch functions, 7&8 lamp ratings and not available with O2 and A termination options.

* J3 actuator not available with markings or Termination option "17" solder lug

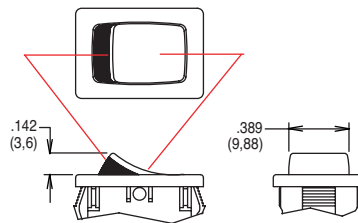

NOTE:

1. Available with DA102 switch function only.
2. Available with None or P actuator marking options only.

Rocker

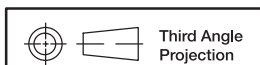

Dimensions are shown: Inches (mm)
Specifications and dimensions subject to change



15 May 20

DA Series Miniature Single Pole Rocker Switches

ACTUATOR

J4 CIRCLE, ILLUMINATED ROCKER

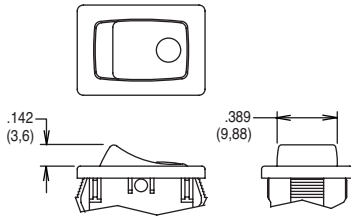

NOTE: Available with DA102 switch function and 7 & 8 lamp ratings combinations only. Not available with O2 and A termination options. * J4 actuator not available with Termination option "17" solder lug

J5 OVAL, ILLUMINATED ROCKER

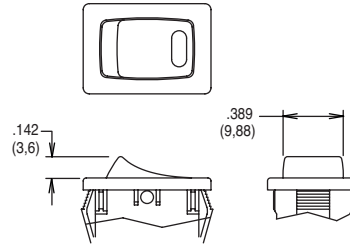

NOTE: Available with DA102 switch function and 6 lamp rating combinations only. Not available with O2 and A termination options. * J5 actuator not available with Termination option "17" solder lug

ACTUATOR COLOR

	OPTION CODE	ACTUATOR COLOR
J1 only	2	BLACK
	1	WHITE
	3	RED
J3, J4, J5 only	R	RED, ILLUMINATED
	A	AMBER, ILLUMINATED
	G	GREEN, ILLUMINATED

	OPTION CODE	ACTUATOR COLOR TOP	ACTUATOR COLOR BOTTOM
J2 only	1	WHITE	RED
	2	WHITE	BLACK
	3	RED	WHITE
	4	BLACK	WHITE
	5	BLACK	RED

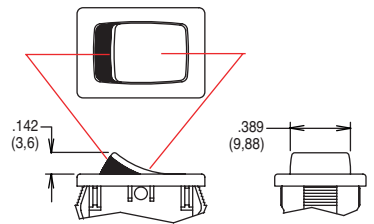

MOUNTING STYLE/COLOR

S2 SNAP-IN, BLACK

S1 SNAP-IN, WHITE

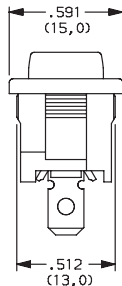
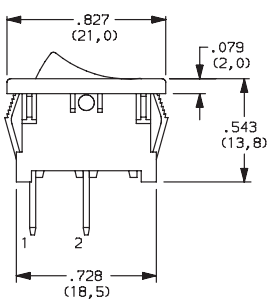

G2 GUARD, BLACK

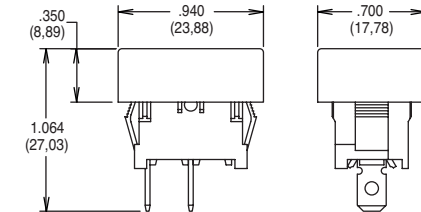

NOTE: Available with DA10X switch functions only.

S2, S1 & G2 PANEL MOUNTING

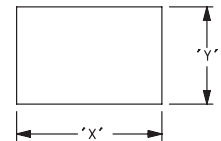

PANEL THICKNESS	"X"	"Y"
0.030-0.049 (0,75-1,25)	0.756-.004 (19,2-0,1)	0.512+.004 (13,0+0,1)
0.049-0.079 (1,25-2,0)	0.764-.004 (19,4-0,1)	0.512+.004 (13,0+0,1)
0.079-0.118 (2,0-3,0)	0.779-.004 (19,8-0,1)	0.512+.004 (13,0+0,1)

Actuator shown in Pos. 1

B2 RECESSED SNAP-IN BRACKET, BLACK

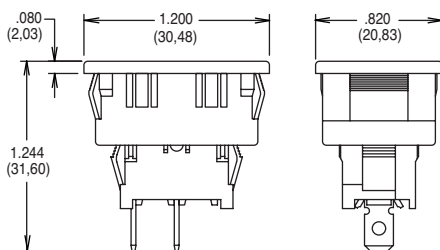

NOTE: Available with DA10X switch functions only.

B2 PANEL MOUNTING

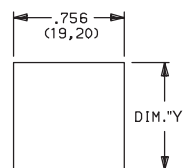

PANEL THICKNESS	"Y"
0.030-0.049 (0,75-0,25)	1.068 (27,13)
0.049-0.079 (1,25-2,0)	1.076 (27,33)
0.079-0.118 (2,0-3,0)	1.092 (27,74)



Dimensions are shown: Inches (mm)
Specifications and dimensions subject to change



DA Series Miniature Single Pole Rocker Switches

TERMINATION

15 .187" QUICK CONNECT

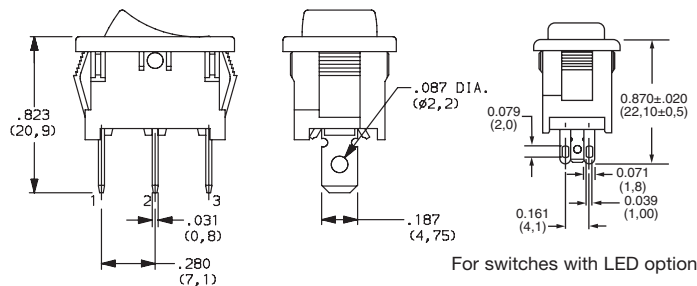

17 SOLDER LUG

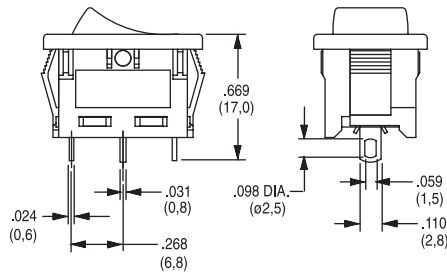

02* THRU-HOLE

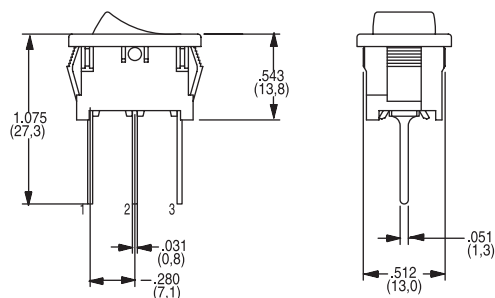

A* RIGHT ANGLE

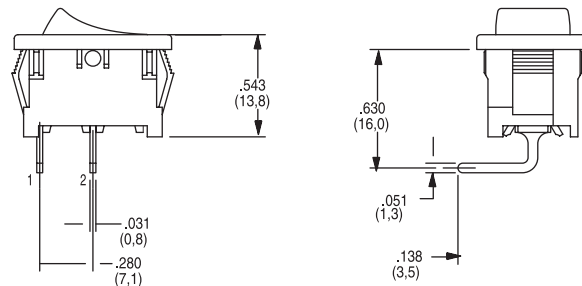

* NOTE - O2 and A termination options not offered with J3, J4 or J5 actuator options.

ACTUATOR MARKING

NONE NO MARKING



D ON-OFF

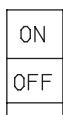

H O I

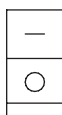

N LARGE DOT



P O -

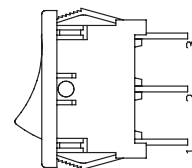

All models shown in Pos. 1
Markings not available with J3 actuator

NOTE: Orientation of actuator marking and terminals.

CONTACT MATERIAL

OPTION CODE	CONTACT AND TERMINAL MATERIAL	RATINGS	
QF	SILVER	POWER	16 AMPS @ 125 VAC; 1/3 HP; 10 AMPS @ 250 VAC; 1/2 10 AMPS @ 125 VAC, 6 AMPS @ 250 VAC

* Note: See Technical Data section of this catalog for RoHS compliant and compatible definitions and specifications.

LAMP RATING

- (NONE) NO LAMP
- 6 LED RATING @ 10 mA $V_f=1.85V$
- 7 125 VAC 33kΩ NEON
- 8 250 VAC 150kΩ NEON

ACCESSORIES

216C00000 IP54 SPLASH PROOF RUBBER BOOT

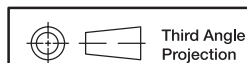
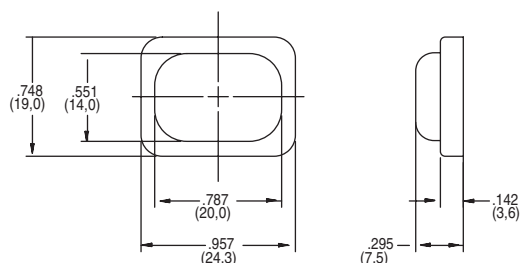

Dimensions are shown: Inches (mm)
Specifications and dimensions subject to change

D Series Miniature Snap-in Power Rocker Switches

Features/Benefits

- Momentary and maintained models
- PC and quick connect terminals
- Recessed bracket available — prevents accidental actuation
- RoHS compliant
- Gold plated options available

Typical Applications

- Small appliances
- Computers and peripherals
- Medical instrumentation

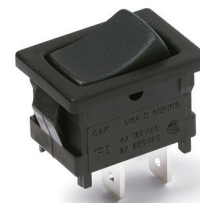

UL 61058-1



Specifications

CONTACT RATING:

D101, D102, D103, D105, D108, D201, D202, D203

GP (general purpose)

4 AMPS 125 VAC 50/60 Hz T85 10,000 cycles

2 AMPS 250 VAC 50/60 Hz T85 10,000 cycles

R (resistive)

4 AMPS 30 VDC T85 10,000 cycles

D501, D502, D503, D508, D601, D602, D608

GP (general purpose)

10 AMPS 125 VAC 50/60 Hz T85 10,000 cycles

5 AMPS 250 VAC 50/60 Hz T85 10,000 cycles

R (resistive)

10 AMPS 30 VDC T85 10,000 cycles

0.4VA @ 20V AC/DC (gold plating) available upon request

ELECTRICAL LIFE: 10,000 make-and-break cycles at full load.

INSULATION RESISTANCE: $10^9 \Omega$ min.

DIELECTRIC STRENGTH: 1,000 Vrms min. @ sea level.

Materials

ACTUATOR & HOUSING: 6/6 nylon (UL 94V-2), color black, finish: matte.

MOVABLE CONTACTS: D10X and D20X Models: Copper, silver plated. D50X and D60X Models: Coin silver, silver plated.

STATIONARY CONTACTS AND TERMINALS: Copper or brass, silver plated. Gold plating available.

CONTACT SPRING: Music wire or stainless steel.

OPERATING TEMPERATURE: -30°C to +65°C

NOTE: Specifications and materials listed above are for standard switches. For information on specific and custom switches, consult Customer Service Center.

Build-A-Switch

To order, simply select desired option from each category and place in the appropriate box. Available options are shown and described on pages G-61 through G-65. For additional options not shown in catalog, consult Customer Service Center.



Switch Function

- D101** SPDT, On-None-On
- D102** SPST, On-None-Off
- D103** SPDT, On-Off-On
- D105** SPDT, Mom.-Off-Mom.
- D108** SPDT, Mom.-None-On
- D201** DPDT, On-None-On
- D202** DPST, On-None-Off
- D203** DPDT, On-Off-On
- D501** SPDT, On-None-On
- D502** SPST, On-None-Off
- D503** SPDT, On-Off-On
- D508** SPDT, Mom.-None-On
- D601** DPDT, On-None-On
- D602** DPST, On-None-Off
- D608** DPDT, Mom.-None-On

Actuator

- J1** Rocker
- J5** Lever

Actuator Color

- 2** Black
- 1** White
- 3** Red

Mounting Style/Color

- S2** Snap-in, black
- B2** Recessed snap-in actuator guard, black
- G2** Actuator guard, black
- S1** Snap-in, white

Terminations

- 15** Quick connect
- A** Right angle, PC thru-hole
- 02** PC Thru-hole
- 05** Twisted quick connect
- 06** Extended PC thru-hole
- 17** Wirable quick connect

Actuator Markings

- NONE** No marking
- D** ON-OFF
- H** O I
- N** Large dot
- P** O -
- R** Red rectangle on end
- U** Large dot on end

Contact Material

- QA** Silver
- Gold plating options available contact Customer Service



15 May 20



D Series Miniature Snap-in Power Rocker Switches

SWITCH FUNCTION

NO. POLES	MODEL NO.	AMP RATING*	SWITCH FUNCTION			CONNECTED TERMINALS			SCHEMATIC	
			POS. 1	POS. 2	POS. 3	POS. 1	POS. 2	POS. 3		
SP	D102	4	ON	NONE	OFF	1-1A	N/A	OPEN		
	D502	10								
	D101	4	ON	NONE	ON			1-1B	OPEN	
	D501	10			ON					
	D103	4	MOM.	OFF	MOM.					
	D503	10								
D105	4	MOM.	NONE	ON						
D108	4									
D508	10									

SPDT

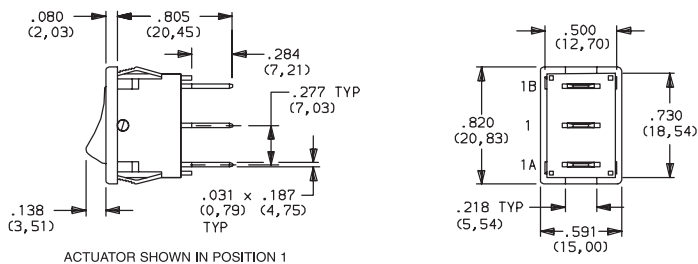

ACTUATOR SHOWN IN POSITION 1

TERMINAL NOS. FOR REF. ONLY

Part number shown: D101J12S215QA

DP	D202	4	ON	NONE	OFF	1-1A, 2-2A	N/A	OPEN		
	D602	10								
	D201	4	ON	NONE	ON			1-1B, 2-2B	OPEN	
	D601	10			ON					
	D203	4	MOM.	NONE	ON					
D608	10									

DPDT

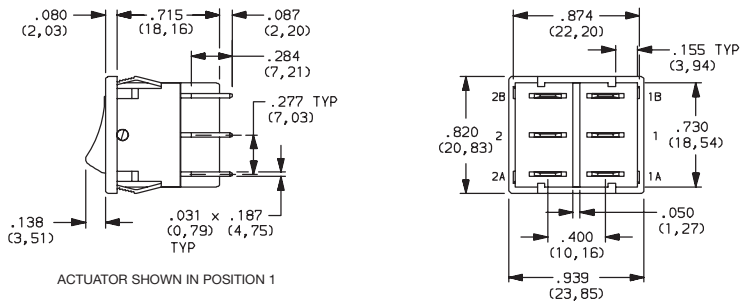

ACTUATOR SHOWN IN POSITION 1

TERMINAL NOS. FOR REF. ONLY

MOM. = Momentary

*AMP RATING: see G-60

See CONTACT MATERIALS, page G-64.



Rocker

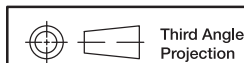

Third Angle Projection

Dimensions are shown: Inches (mm)
Specifications and dimensions subject to change



15 May 20

D Series Miniature Snap-in Power Rocker Switches



J1 ROCKER

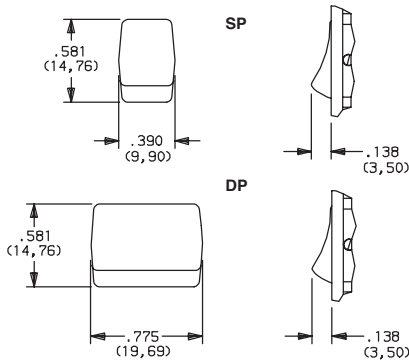

J5 LEVER

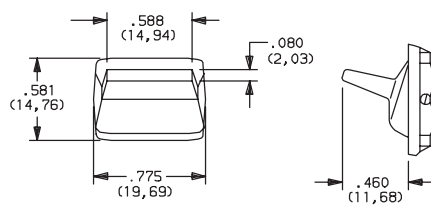

OPTION CODE	ACTUATOR COLOR
2	BLACK
1	WHITE
3	RED

NOTE: Actuator finish: matte. Other colors available, consult Customer Service Center.

'J5' actuator available only with DP models D201, D202, D601 and D602.

MOUNTING STYLE/COLOR

S SNAP-IN

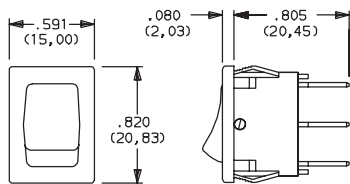

OPTION CODE	HOUSING COLOR
2	(STD.) BLACK
1	WHITE

NOTE: Frame finish on housing: matte. Other colors available, consult Customer Service Center.

B2 RECESSED SNAP-IN ACTUATOR GUARD, BLACK

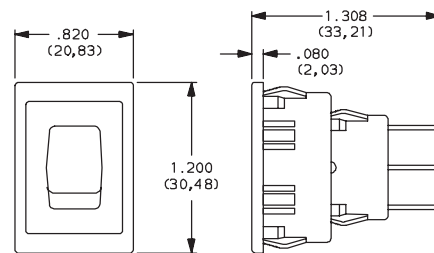

NOTE: Vertical mount, SP models only.

G2 ACTUATOR GUARD, BLACK

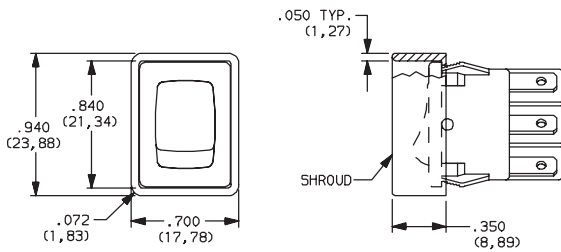

NOTE: Vertical mount, SP models only.

PANEL MOUNTING

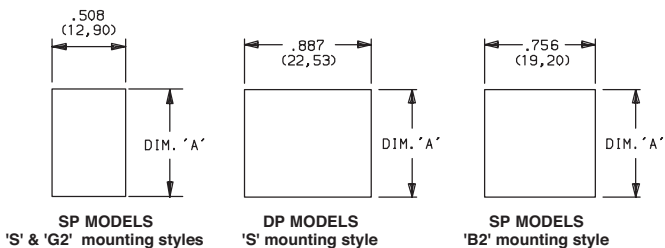

PANEL THICKNESS	DIM 'A' SP & DP MODELS 'S' MOUNTING STYLE	DIM 'A' WITH 'G2' OPTION SP MODELS ONLY	DIM 'A' SP MODELS 'B' MOUNTING STYLE
.030-.049 (0,76) (1,24)	.756 (19,20)	.764 (19,41)	1.068 (27,13)
.049-.079 (1,24) (2,01)	.764 (19,41)	.780 (19,81)	1.076 (27,33)
.079-.118 (2,01) (3,00)	.780 (19,81)	n/a	1.092 (27,74)

NOTE: Blank insert available for SP models only, see page G-64.

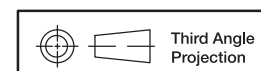

Dimensions are shown: Inches (mm)
 Specifications and dimensions subject to change



15 May 20



D Series Miniature Snap-in Power Rocker Switches

TERMINATIONS

A RIGHT ANGLE, PC THRU-HOLE

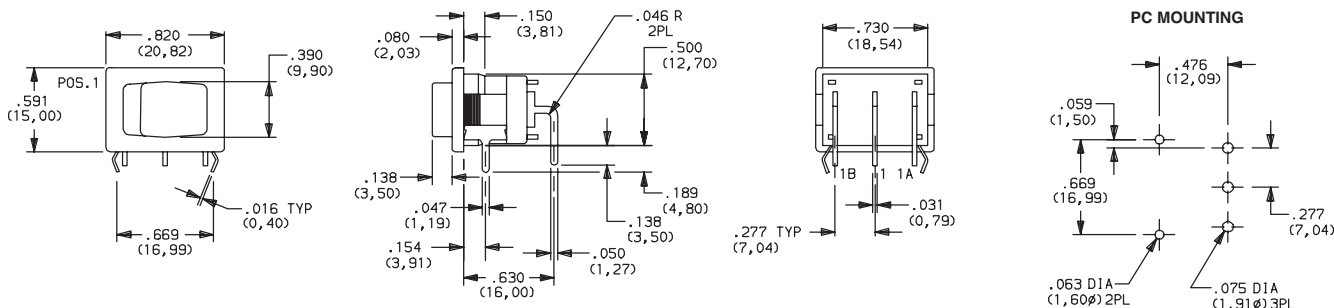

Available with D101, D102, D501, D502 SP models only.

TERMINATIONS

02 PC THRU-HOLE

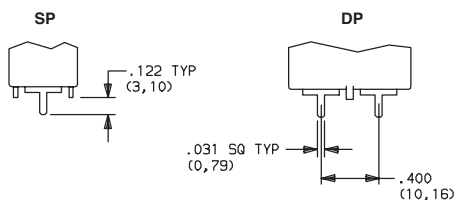

Available with DX01 and DX02 models only.

06 EXTENDED PC THRU-HOLE

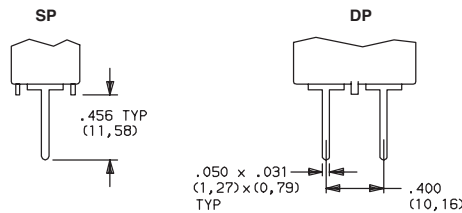

Available with DX01 and DX02 models only.

PC MOUNTING (02 and 06)

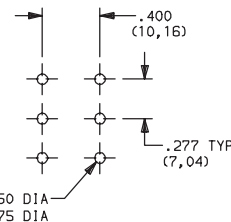

15 QUICK CONNECT

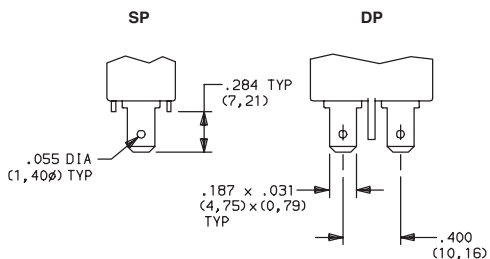

Available with DX01 and DX02 models only.

05 TWISTED QUICK CONNECT

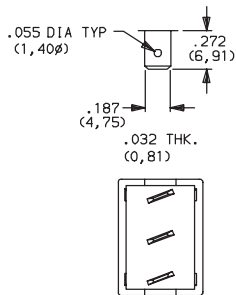

NOTE: Terminals are twisted.

17 WIRABLE QUICK CONNECT

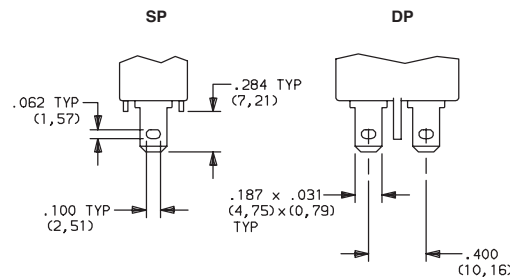

Available with DX01 and DX02 models only.

ACTUATORS

NONE NO MARKING

D ON-OFF

H O |

N LARGE DOT

P O -

R RED RECTANGLE ON END

U LARGE DOT ON END

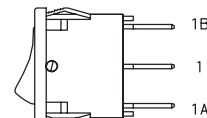

'D, H, P & U' marking options: marking color white, standard for all actuator colors except white. Black marking color, standard for white actuators. 'R & N' marking option: red marking color, standard. Consult Customer Service Center for other available marking colors.

NOTE: Orientation of actuator markings and terminals.



Dimensions are shown: Inches (mm)
Specifications and dimensions subject to change

D Series Miniature Snap-in Power Rocker Switches

CONTACT MATERIAL

OPTION CODE	CONTACT AND TERMINAL MATERIAL	RATINGS
QA	SILVER 1	D101, D102, D103, D105, D108, D201, D202, D203
		GP (general purpose) 4 AMPS 125 VAC 50/60 Hz T85 10,000 cycles
		2 AMPS 250 VAC 50/60 Hz T85 10,000 cycles
		R (resistive) 4 AMPS 30 VDC T85 10,000 cycles
		D501, D502, D503, D508, D601, D602, D608
		GP (general purpose) 10 AMPS 125 VAC 50/60 Hz T85 10,000 cycles
		5 AMPS 250 VAC 50/60 Hz T85 10,000 cycles
		R (resistive) 10 AMPS 30 VDC T85 10,000 cycles

¹MOVABLE CONTACT: D10X and D20X MODELS: Copper, silver plated.
D50X and D60X MODELS: Coin silver, silver plated.



0.4VA @ 20V AC/DC Gold plated options available contact Customer Service.

STATIONARY CONTACTS & TERMINALS: Copper or brass, silver plated.

AVAILABLE HARDWARE

Insert
SP Only

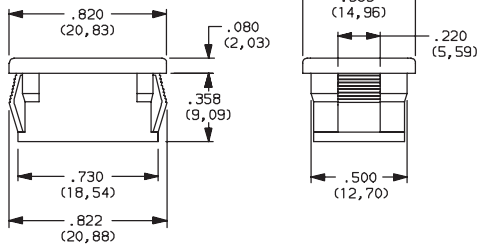

PART NO.
057190200 BLACK
Material: Nylon 6/6
Finish: Matte

Recessed Actuator Guard,
SP Only

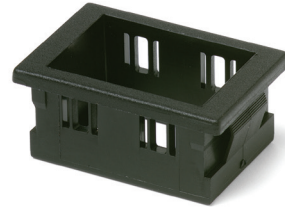

599D02000 BLACK
Material: 6/6 Nylon
Finish: Matte

Actuator Guard

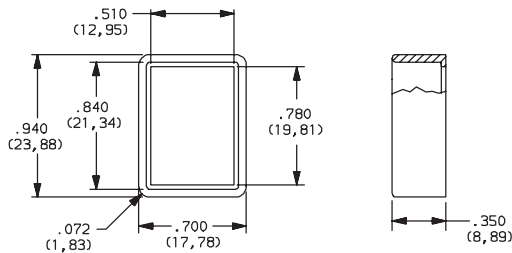

PART NO.
104C22000
Material: PBT thermoplastic
Finish: Matte

PART NO.
216C00000 IP54 SPLASH PROOF RUBBER BOOT

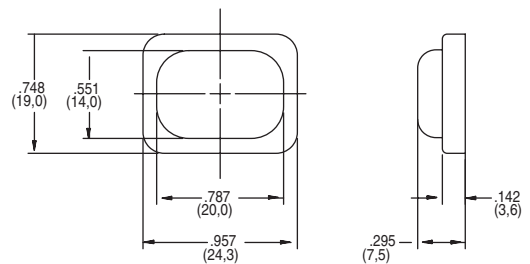

15 May 20

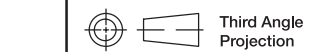

Third Angle
Projection
Dimensions are shown: Inches (mm)
Specifications and dimensions subject to change



DM Series Miniature 2 Pole Power Rocker Switches



Features/Benefits

- 3 AMPS to 10 AMPS
- Quick connect terminals
- Double pole in miniature size
- Recessed bracket available—prevents accidental actuation
- RoHS compliant

Typical Applications

- Computers
- Appliances
- Electric tools

UL 61058-1



Specifications

CONTACT RATING:

DM21, DM22:

GP (general purpose)

3 AMPS 125 VAC 50/60 Hz T85 10,000 cycles

2 AMPS 250 VAC 50/60 Hz T85 10,000 cycles

R (resistive)

3 AMPS 30 VDC T85 10,000 cycles

DM61, DM62:

GP (general purpose)

10 AMPS 125 VAC 50/60 Hz T85 10,000 cycles

5 AMPS 250 VAC 50/60 Hz T85 10,000 cycles

R (resistive)

10 AMPS 30 VDC T85 10,000 cycles

ELECTRICAL LIFE: 10,000 make-and-break cycles at full load.

INSULATION RESISTANCE: $10^9 \Omega$ min.

DIELECTRIC STRENGTH: 1,000 Vrms min. @ sea level.

OPERATING TEMPERATURE: -20°C to +65°C

Materials

HOUSING & ACTUATOR: 6/6 nylon (UL94V-2), black.

MOVABLE CONTACTS: DM2X Models: Copper, silver plated.

DM6X Models: Coin silver, silver plated.

STATIONARY CONTACTS & TERMINALS: Copper or brass, silver plated.

CONTACT SPRING: Music wire or stainless steel.

NOTE: Any models supplied with Q contact material are RoHS compliant.

NOTE: Specifications and materials listed above are for standard switches. For information on specific and custom switches, consult Customer Service Center.

Build-A-Switch

To order, simply select desired option from each category and place in the appropriate box. Available options are shown and described on pages G-66 and G-69. For additional options not shown in catalog, consult Customer Service Center.

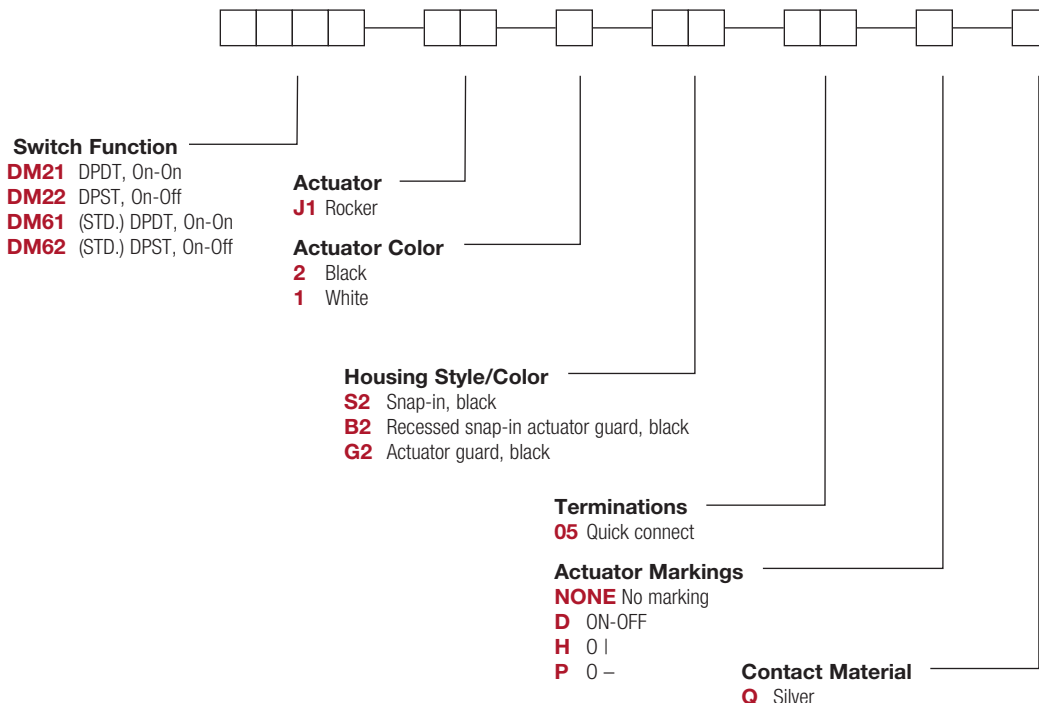

DM Series Miniature 2 Pole Power Rocker Switches

SWITCH FUNCTION



NO. POLES	MODEL NO.	AMP RATING*	SWITCH FUNCTION		CONNECTED TERMINALS		SCHEMATIC
			POS. 1	POS. 2	POS. 1	POS. 2	
DP	DM22	3	ON	OFF	1-1A, 2-2A	OPEN	
	DM62	10	ON	OFF	1-1A, 2-2A	OPEN	
	DM21	3	ON	ON	1-1A, 2-2A	1-1B, 2-2B	
	DM61	10	ON	ON	1-1A, 2-2A	1-1B, 2-2B	

DPDT

PART NUMBER SHOWN: DM21J1XS205Q

NOTES 1. ACTUATOR SHOWN IN POSITION 1-'ON' POSITION

RATINGS: See page G-65 for complete ratings.



UL 61058-1 tested to 30C temperature rise @ 6,000 cycles.

ACTUATOR

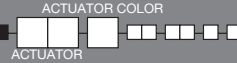

J1 ROCKER

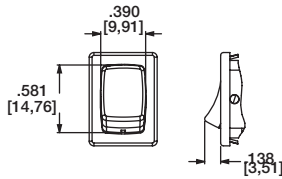

OPTION CODE	ACTUATOR COLOR
2	BLACK
1	WHITE

NOTE: Actuator finish: matte. Other colors available, consult Customer Service Center.

HOUSING STYLE/COLOR



S2 SNAP-IN, BLACK

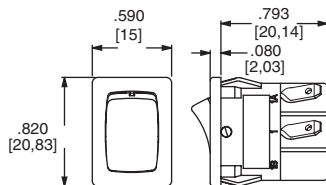

NOTE: Housing finish: matte. Other colors available, consult Customer Service Center.

B2 RECESSED SNAP-IN ACTUATOR GUARD, BLACK

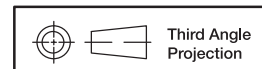
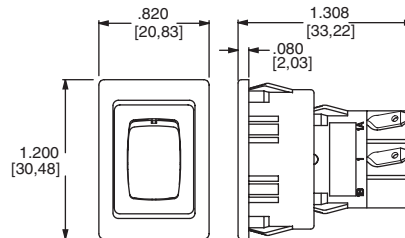

Dimensions are shown: Inches (mm)
Specifications and dimensions subject to change



15 May 20



DM Series Miniature 2 Pole Power Rocker Switches

HOUSING STYLE/COLOR

G2 ACTUATOR GUARD, BLACK

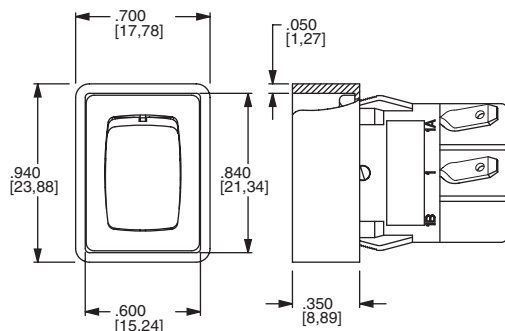

PANEL MOUNTING

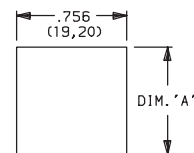
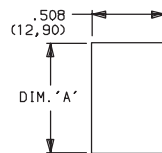

'S2' & 'G2' housing styles

'B2' housing style

NOTE: Blank insert available for SP models only, see page H-76.

PANEL THICKNESS	DIM 'A' 'S2' & 'G2' HOUSING STYLES	DIM 'A' 'G2' OPTION SP MODELS ONLY	DIM 'A' 'B2' HOUSING STYLES
.030-.049 (0,76) (1,24)	.756 (19,20)	0.764 (19,41)	1.068 (27,13)
.049-.079 (1,24) (2,01)	.764 (19,41)	0.780 (19,81)	1.076 (27,33)
.079-.118 (2,01) (3,00)	.780 (19,81)	n/a	1.092 (27,74)

TERMINATIONS

05 QUICK CONNECT

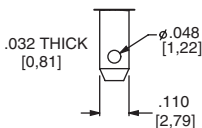

ACTUATOR MARKINGS

NONE NO MARKING

D ON-OFF

H O I

P O -

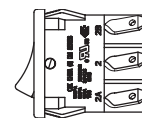
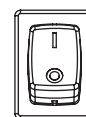

NOTE: Orientation of actuator markings and terminals.

'D' & 'P' marking options: marking color white, standard for all actuator colors except white actuators. Black marking color standard for white actuators. Consult Customer Service Center for other available marking colors.

CONTACT MATERIAL

OPTION CODE	CONTACT AND TERMINAL MATERIAL	RATINGS		
Q	SILVER 1,2	DM21, DM22:	GP (general purpose)	3 AMPS 125 VAC 50/60 Hz T85 10,000 cycles
				2 AMPS 250 VAC 50/60 Hz T85 10,000 cycles
		DM61, DM62:	R (resistive)	3 AMPS 30 VDC T85 10,000 cycles
			GP (general purpose)	10 AMPS 125 VAC 50/60 Hz T85 10,000 cycles
		5 AMPS 250 VAC 50/60 Hz T85 10,000 cycles		
		R (resistive)	10 AMPS 30 VDC T85 10,000 cycles	

* Note: See Technical Data section of this catalog for RoHS compliant and compatible definitions and specifications.

¹ MOVABLE CONTACT: DM2X Models: Copper, silver plated.
DM6X Models: Coin silver, silver plated.

² STATIONARY CONTACTS & TERMINALS: Copper or brass, silver plated.

NOTE: Any models supplied with Q contact material are RoHS compliant.

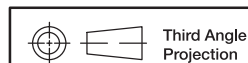

Dimensions are shown: Inches (mm)
Specifications and dimensions subject to change

DM Series Miniature 2 Pole Power Rocker Switches

AVAILABLE HARDWARE

Insert

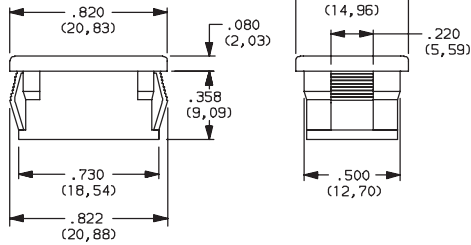

PART NO.
057190200

Material: Nylon 6/6
Finish: Matte

Recessed Actuator Guard

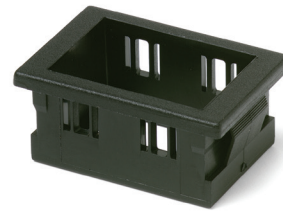

PART NO.
599D02000

Material: 6/6 Nylon
Finish: Matte

Actuator Guard

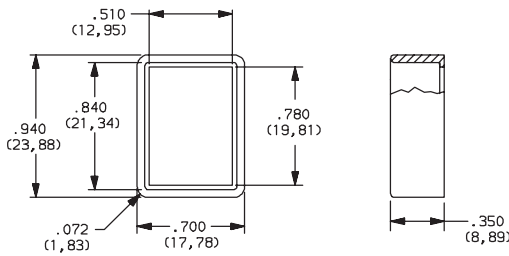

PART NO.
104C22000

Material: PBT thermoplastic
Finish: Matte

PART NO.
216C00000 IP54 SPLASH PROOF RUBBER BOOT

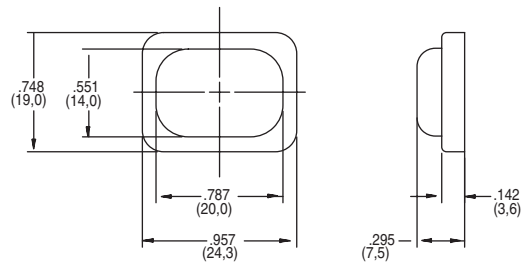

DM Series Miniature Illuminated Power Rocker Switches

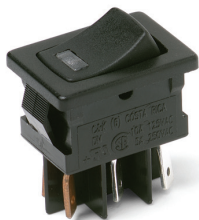

Features/Benefits

- 3 AMPS to 10 AMPS
- Illuminated LED
- Positive detent
- RoHS compliant

Typical Applications

- Instrumentation
- Industrial
- Office machines



Specifications

CONTACT RATING:

DM14 and DM24 Models:

GP (general purpose)

3 AMPS @ 125 V AC; 2 AMPS @ 250 V AC.

R (resistive)

3 AMPS 30 VDC 10,000 cycles

DM54 and DM64 Models:

GP (general purpose)

10 AMPS @ 125 V AC; 5 AMPS @ 250 V AC (UL).

R (resistive)

10 AMPS 30 VDC 10,000 cycles

ELECTRICAL LIFE: 10,000 make-and-break cycles at full load.

INSULATION RESISTANCE: $10^9 \Omega$ min.

DIELECTRIC STRENGTH: 1,000 Vrms min. @ sea level.

Materials

HOUSING: 6/6 nylon (UL94V-2), black.

ACTUATOR: 6/6 nylon (UL94V-2), black.

MOVABLE CONTACTS: DM14 and DM24 Models: Copper, silver plated. DM54 and DM64 Models: Coin silver, silver plated.

STATIONARY CONTACTS & TERMINALS: Copper or brass, silver plated.

LED TERMINALS: Brass, unplated.

CONTACT SPRING: Music wire or stainless steel.

OPERATING TEMPERATURE: -20°C to +65°C

NOTE: Any models supplied with Q contact material are RoHS compliant.

NOTE: Specification and materials listed above are for standard switches. For information on specific and custom switches, consult Customer Service Center.

Build-A-Switch

To order, simply select desired option from each category and place in the appropriate box. Available options are shown and described on pages G-70 and G-73. For additional options not shown in catalog, consult Customer Service Center.

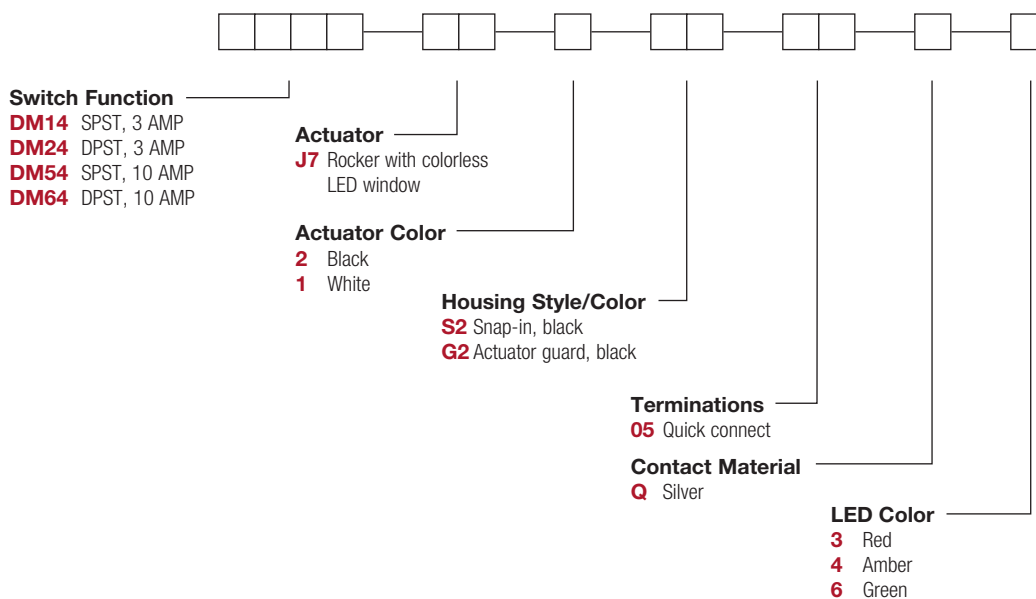

DM Series Miniature Illuminated Power Rocker Switches

SWITCH FUNCTION



NO. POLES	MODEL NO.	AMP RATING*	SWITCH FUNCTION		CONNECTED TERMINALS		SCHEMATIC
			POS. 1	POS. 2	POS. 1	POS. 2	
SP	DM14	3	ON	OFF	1-1A	OPEN	
	DM54	10					
DP	DM24	3	ON	OFF	1-1A, 2-2A	OPEN	
	DM64	10					

DPDT

Actuator shown in pos. 1 - 'ON' position.
SPST MODELS (DM14 & DM54) OMIT TERMINALS 2 & 2A.

Part number shown: DM24J72S205Q3

* RATINGS: see page G-69.



ACTUATOR



J7 ROCKER WITH COLORLESS LED WINDOW

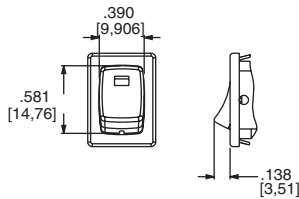

OPTION CODE	ACTUATOR COLOR
2	BLACK
1	WHITE

NOTE: Other colors available, consult Customer Service Center.

HOUSING STYLE/COLOR



S2 SNAP-IN, BLACK

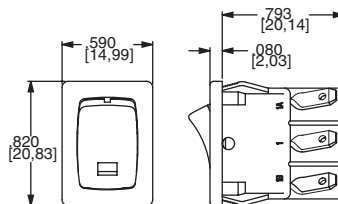

NOTE: Housing finish: matte. Other colors available, consult Customer Service Center.

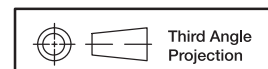

Dimensions are shown: Inches (mm)
Specifications and dimensions subject to change



15 May 20



DM Series Miniature Illuminated Power Rocker Switches

HOUSING STYLE/COLOR

G2 ACTUATOR GUARD, BLACK

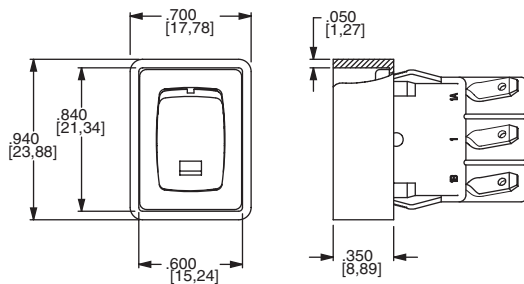

PANEL MOUNTING

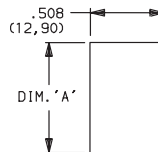

'S2' & 'G2' housing style

NOTE: Blank insert available for SP models only, see page H-80.

PANEL THICKNESS	DIM 'A' 'S2' & 'G2' HOUSING STYLES	DIM 'A' with 'G2' option SP MODELS ONLY
.030-.049 (0,76) (1,24)	0.756 (19,20)	0.764 (19,41)
.049-.079 (1,24) (2,01)	0.764 (19,41)	0.780 (19,81)
.079-.118 (2,01) (3,00)	.780 (19,81)	n/a

TERMINATIONS

05 QUICK CONNECT

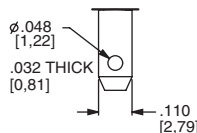

CONTACT MATERIAL

OPTION CODE	CONTACT AND TERMINAL MATERIAL	RATINGS			
Q	SILVER 1,2	POWER	DM14, DM24:	GP (general purpose)	3 AMPS @ 125 V AC; 2 AMPS @ 250 V AC.
				R (resistive)	3 AMPS 30 VDC 10,000 cycles
			DM54, DM64:	GP (general purpose)	10 AMPS @ 125 V AC; 5 AMPS @ 250 V AC.
				R (resistive)	10 AMPS 30 VDC 10,000 cycles

* Note: See Technical Data section of this catalog for RoHS compliant and compatible definitions and specifications.

¹ MOVABLE CONTACTS: DM14 and DM24 models: Copper, silver plated.
DM54 and DM64 models: Coin silver, silver plated.

² STATIONARY CONTACTS & TERMINALS: Copper or brass, silver plated.

NOTE: Any models supplied with Q contact material are RoHS compliant.



LED COLOR

OPTION CODE	LED COLOR	FORWARD V _{FD}	CURRENT I _{LED}	REVERSE V _R	INTENSITY M _{CD}	RECOMMENDED RESISTOR @ VOLTAGE		
						5V	12V	24V
3	Red	2.1	10	4V	1.6 typ.	270	1K	2.2K
4	Amber	2.2	20	4V	2.5 typ.	150	510	1.2K
6	Green	2.1	20	4V	2.0 typ.	150	510	1.2K



Dimensions are shown: Inches (mm)
Specifications and dimensions subject to change

Rocker



15 May 20

DM Series Miniature Illuminated Power Rocker Switches

AVAILABLE HARDWARE

Blank Insert

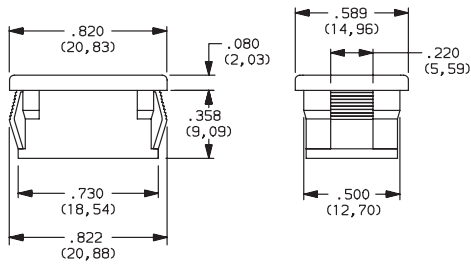

PART NO.
057190200

Material: Zinc nylon 6/6
Finish: Matte

Recessed Bracket

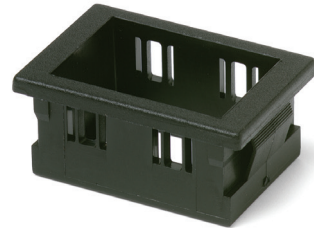

PART NO.
599D02000

Material: 6/6 Nylon
Finish: Matte

Actuator Guard

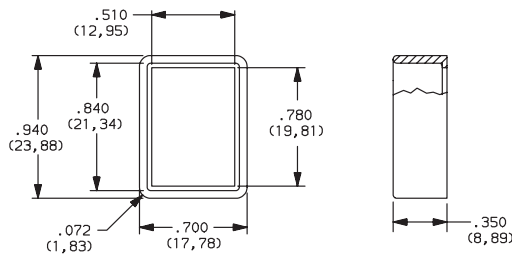

PART NO.
104C22000

Material: PBT thermoplastic
Finish: Matte

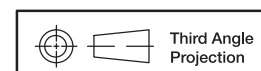

Dimensions are shown: Inches (mm)
Specifications and dimensions subject to change

DF Series Power Rocker Switches



Features/Benefits

- Power switching up to 16 AMPS
- Sub-panel and Front-panel mounting
- PC and quick connect terminals
- Multi-position and multi-pole function
- RoHS compliant

Typical Applications

- Computers
- Power supplies
- Appliances
- Fitness equipment
- Off-road vehicles



Specifications

CONTACT RATING: 16 AMPS @ 125, 250 V AC; 1/4 HP @ 125 V AC; 1/2 HP @ 250 V AC; 6 AMPS @ 48 V DC, 2 AMPS @ 60 V DC, 11 AMPS @ 30 V DC

ELECTRICAL LIFE: 10,000 make-and-break cycles at full load.

INSULATION RESISTANCE: $10^9 \Omega$ min.

DIELECTRIC STRENGTH: 1,000 Vrms min. @ sea level.

OPERATING TEMPERATURE: -20°C to +85°C

Materials

HOUSING & ACTUATOR: 6/6 nylon (UL 94V-2), black, finish: matte.

CONTACTS: Fine silver, silver plated.

TERMINALS: Copper, silver plated.

CONTACT SPRING: Music wire or stainless steel.

NOTE: Specifications and materials listed above are for standard switches. For information on specific and custom switches, consult Customer Service Center.

Build-A-Switch

To order, simply select desired option from each category and place in the appropriate box. Available options are shown and described on pages G-74 thru G-76. For additional options not shown in catalog, consult Customer Service Center.

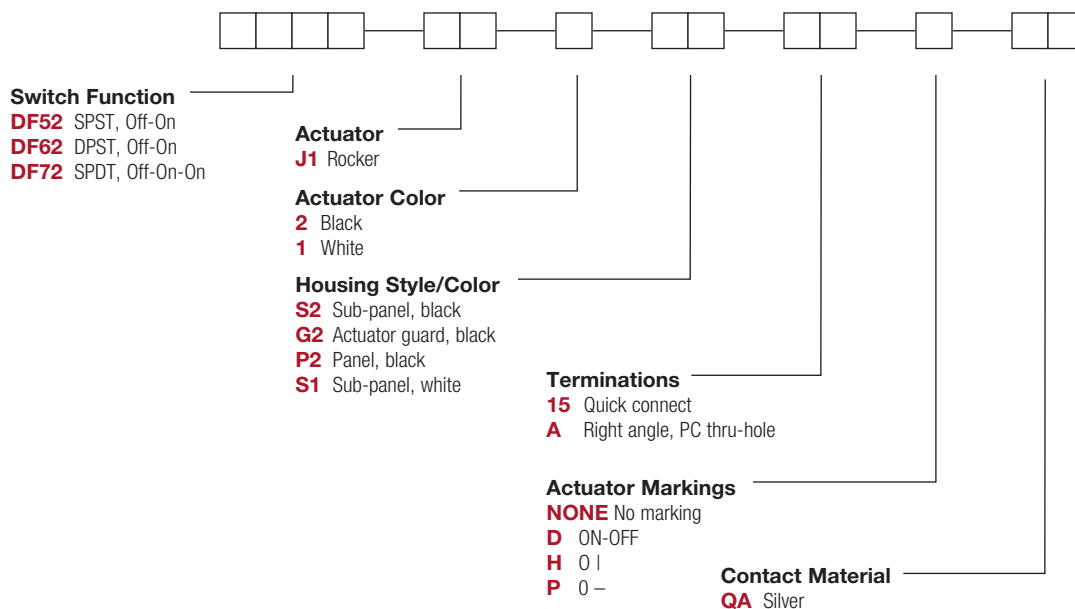

DF Series Power Rocker Switches

SWITCH FUNCTION



NO. POLES	MODEL NO.	SWITCH FUNCTION		CONNECTED TERMINALS		SCHEMATIC
		POS. 1	POS. 2	POS. 1	POS. 2	
SP	DF52	OFF	ON	OPEN	1-1A	SPST
DP	DF62	OFF	ON	OPEN	1-1A, 2-2A	DPST

Part Number shown DF62J12S215QA

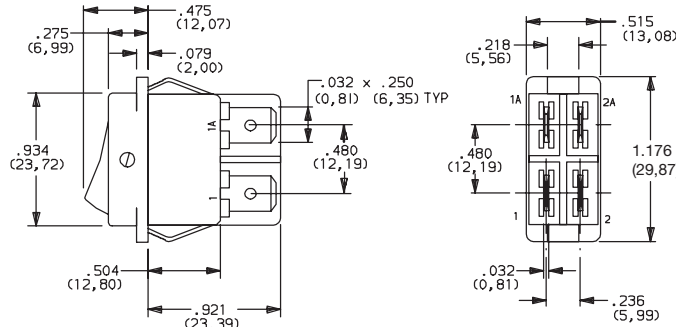

Actuator shown in Pos. 1

NO. POLES	MODEL NO.	POS. 1	POS. 2	POS. 3	POS. 1	POS. 2	POS. 3	SCHEMATIC
SP	DF72	OFF	ON	ON	OPEN	1 / 2-2A	1 / 2-1A 1 / 2-2A	POS. 1: POS. 2: POS. 3:

All models

ACTUATOR

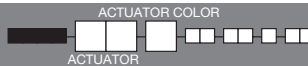

J1 ROCKER

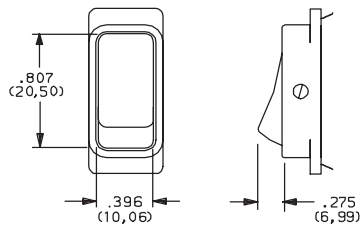

OPTION CODE	ACTUATOR COLOR
2	BLACK
1	WHITE

NOTE: Actuator finish: matte. Other colors available, consult Customer Service Center.

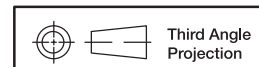

Third Angle
Projection

Dimensions are shown: Inches (mm)
Specifications and dimensions subject to change



DF Series Power Rocker Switches

HOUSING STYLE/COLOR



S SUB-PANEL

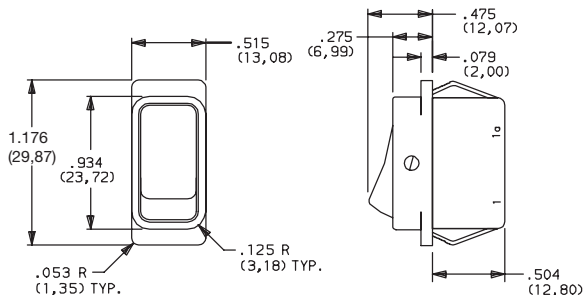

NOTE: DF52 & DF62 models only.

G2 ACTUATOR GUARD

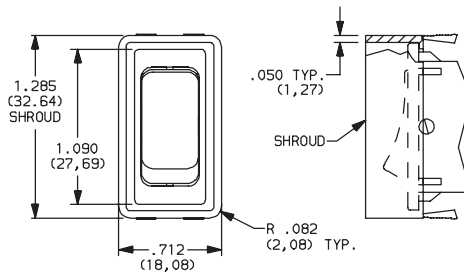

NOTE: Not available with 'A' termination. Available in black only.

P PANEL

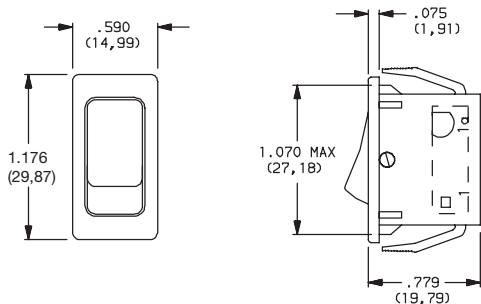

NOTE: Not available with 'A' termination. Available in black only.

OPTION CODE	HOUSING COLOR
2	(STD.) BLACK
1	WHITE

NOTE: Housing finish: matte. Other colors available, consult Customer Service Center.

PANEL MOUNTING

PANEL THICKNESS	DIM 'A'
.029-.048 (0.74) (1.22)	1.021 (25.93)
.048-.078 (1.22) (1.98)	1.029 (26.14)
.078-.117 (1.98) (2.97)	1.045 (26.54)
.075-.140 (1.91) (3.56)	1.075 (27.31)

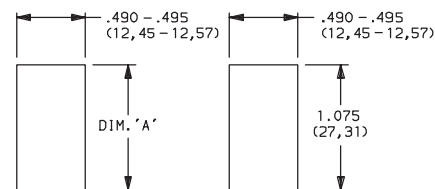

DF52 & DF62 Models with 'S' housing style

DF52, DF62 & DF72 Models with 'P2' & 'G2' housing style

TERMINATIONS



15 QUICK CONNECT

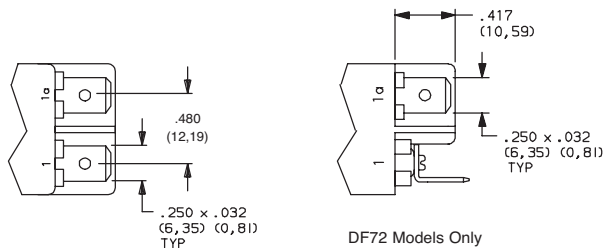

A RIGHT ANGLE, PC THRU-HOLE

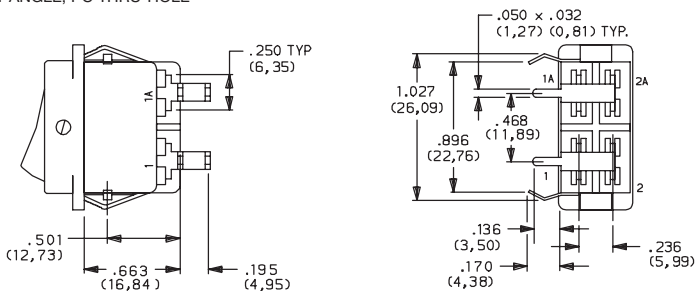

Actuator shown in Pos. 1

NOTE: DF52 and DF62 Models Only

PC MOUNTING

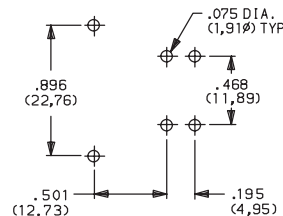

Dimensions are shown: Inches (mm)
Specifications and dimensions subject to change

DF Series Power Rocker Switches

ACTUATOR MARKINGS

NONE NO MARKING

D ON-OFF

H O |

P O -

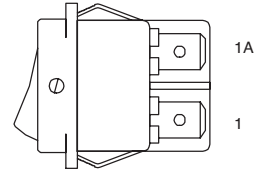

NOTE: Orientation of actuator markings and terminals.

'D, H, & P' marking options: marking color white, standard for all actuator colors except white. Marking color black, standard for white actuators. Consult Customer Service Center for other available marking colors.

CONTACT MATERIAL

OPTION CODE	CONTACT AND TERMINAL MATERIAL	RATINGS	
QA	SILVER ^{1,2}	POWER	16 AMPS @ 125, 250 V AC; 1/4 HP @ 125 V AC; 1/2 HP @ 250 V AC; 6 AMPS @ 48 V DC (UL), 2 AMPS @ 60 V DC, 11 AMPS @ 30 V DC
			16 AMPS @ 125, 250 V AC; 1/4 HP @ 125 V AC; 1/2 HP @ 250 V AC (UL)

* Note: See Technical Data section of this catalog for RoHS compliant and compatible definitions and specifications.

¹ CONTACTS: Fine silver, silver plated.

All models 

² TERMINALS: Copper, silver plated.

AVAILABLE HARDWARE

Actuator Guard

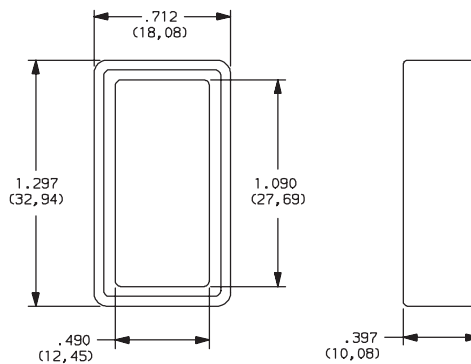

PART NO.

285B02000

Material: Nylon 6/6

Finish: Matte

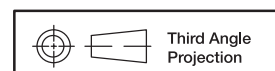

Dimensions are shown: Inches (mm)
Specifications and dimensions subject to change



CR Series Round Single Pole Specialty Rocker Switches

Features/Benefits

- Round actuator and body
- Nice styling
- Multiple illuminated versions available
- IP65 splash proof rubber boot option

Typical Applications

- Appliances, small and large
- Office equipment
- Computers and peripherals
- Audio/Video equipment
- RoHS compliant



UL US UL 61058-1

Specifications

CONTACT RATING:

16 AMPS @ 125 VAC, 10 AMPS @ 250 VAC.

16 AMPS @ 125 VAC, 10 AMPS @ 250 VAC.

ELECTRICAL LIFE: 10,000 make and break cycles at full load.

INSULATION RESISTANCE: $10^8 \Omega$ min.

DIELECTRIC STRENGTH: 1,500 VRMS @ sea level.

OPERATING TEMPERATURE: -20°C to + 85°C

Materials

HOUSING AND ACTUATOR: 6/6 nylon (UL94V-2), matte finish.

ILLUMINATED ACTUATOR: Polycarbonate, matte finish.

CENTER CONTACTS: Silver plated, copper alloy.

END CONTACTS: Silver plated $AgSnO_2InO_3$.

ALL TERMINALS: Silver plated, copper alloy.

NOTE: Specifications and materials listed above are for switches with standard options. For information on specific and custom switches, consult Customer Service Center.

Build-A-Switch

To order, simply select desired option from each category and place in the appropriate box. Available options are shown and described on pages G-78 through G-80. For additional options not shown in catalog, consult Customer Service Center.

<div style="border: 1px solid black; width: 100px; height: 20px; display: inline-block;"></div>		<div style="border: 1px solid black; width: 40px; height: 20px; display: inline-block;"></div>		<div style="border: 1px solid black; width: 40px; height: 20px; display: inline-block;"></div>		<div style="border: 1px solid black; width: 40px; height: 20px; display: inline-block;"></div>		<div style="border: 1px solid black; width: 40px; height: 20px; display: inline-block;"></div>		<div style="border: 1px solid black; width: 40px; height: 20px; display: inline-block;"></div>		<div style="border: 1px solid black; width: 40px; height: 20px; display: inline-block;"></div>		<div style="border: 1px solid black; width: 40px; height: 20px; display: inline-block;"></div>	
Switch Function		Actuator		Actuator Color		Mounting Style/Color		Termination		Contact Rating		Lamp Rating			
CR101 SPDT On-None-On CR102 SPST On-None-Off		J1 Rocker J2* Two-tone rocker J3 Illuminated rocker J4** Circle, illuminated rocker J5 Oval, illuminated rocker JN Paddle, rocker JP Paddle, illuminated rocker		2 Black 1 White 3 Red R Red, illuminated A Amber, illuminated G Green, illuminated		S2 Snap-in, black S1 Snap-in, white		15 .187" quick connect		QF Silver		(NONE) No lamp 6 LED 7 125 VAC neon 8 250 VAC neon			

* Refer to table on page G-79 for actuator options.

CR Series Round Single Pole Specialty Rocker Switches

SWITCH FUNCTION

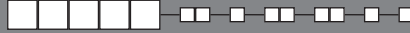

NO. POLES	MODEL NO.	SWITCH FUNCTION			CONNECTED TERMINALS			SCHEMATIC
		Pos. 1	Pos. 2	Pos. 3	Pos. 1	Pos. 2	Pos. 3	
	CR101	ON	NONE	ON	2-3		2-1	
	CR102	ON	NONE	OFF		N/A		
SP								For 7 & 8 Illuminated Versions

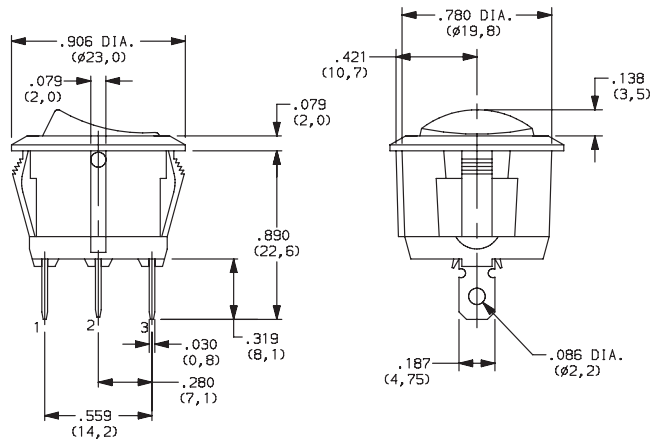

ACTUATOR



- J1** ROCKER
- J3** ILLUMINATED ROCKER

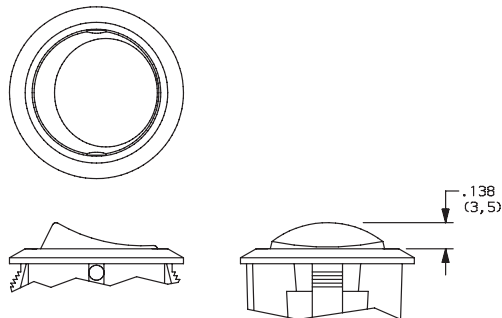

- J2** TWO-TONE ROCKER

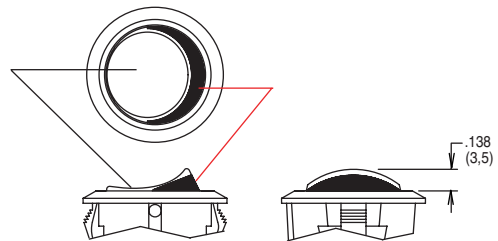

NOTE: J3 actuator available with the combination of 7 & 8 lamp ratings and CR102 switch function only.

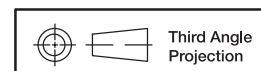

Dimensions are shown: Inches (mm)
Specifications and dimensions subject to change



CR Series Round Single Pole Specialty Rocker Switches

ACTUATOR



J4 CIRCLE, ILLUMINATED ROCKER

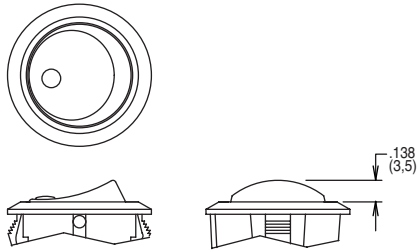

NOTE: Available with the combination of CR102 switch function and 7 & 8 lamp ratings only.

J5 OVAL, ILLUMINATED ROCKER

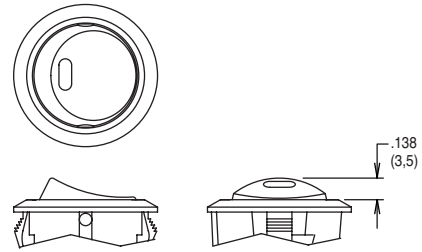

NOTE: Available with the combination of CR102 switch function and 6 lamp rating only.

JN PADDLE, ROCKER

JP PADDLE, ILLUMINATED ROCKER

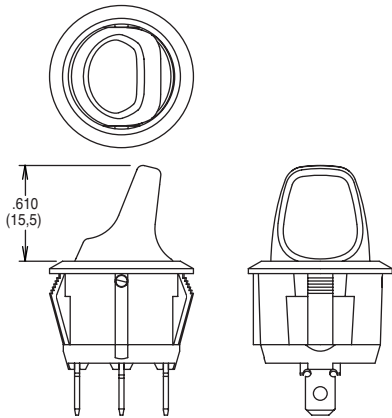

NOTE: JP actuator available with the combination of CR102 switch function and 7 & 8 lamp ratings only.

ACTUATOR COLOR



ACTUATOR	OPTION CODE	ACTUATOR COLOR
J1	2	BLACK
	1	WHITE
	3	RED
J3, J4 J5, JP	R	RED, ILLUMINATED
	A	AMBER, ILLUMINATED
	G	GREEN, ILLUMINATED

ACTUATOR	OPTION CODE	ACTUATOR COLOR	
		TOP	BOTTOM
J2	1	WHITE	RED
	2	WHITE	BLACK
	3	RED	WHITE
	4	BLACK	WHITE
	5	BLACK	RED

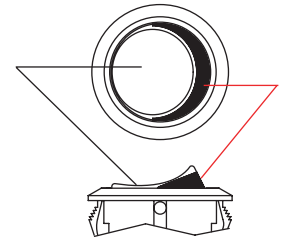

J2 actuator only

MOUNTING STYLE/COLOR



S2 SNAP-IN, BLACK

S1 SNAP-IN, WHITE

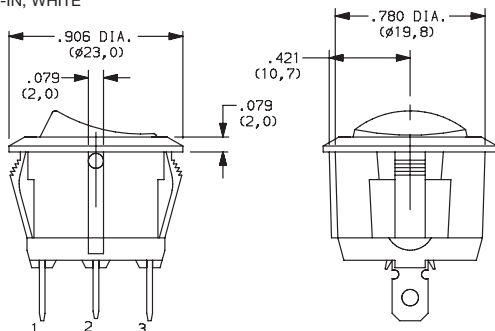

PANEL MOUNTING

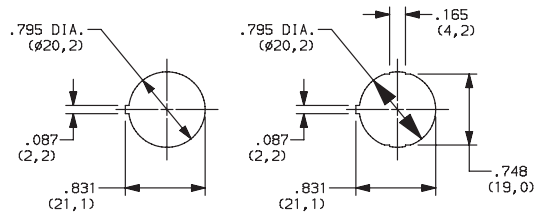

Panel thickness:
2.0 - 3.0 mm

Panel thickness:
0.7 - 3.0 mm

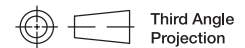

Dimensions are shown: Inches (mm)
Specifications and dimensions subject to change

Rocker

G



CR Series Round Single Pole Specialty Rocker Switches

TERMINATION



15 .187" QUICK CONNECT

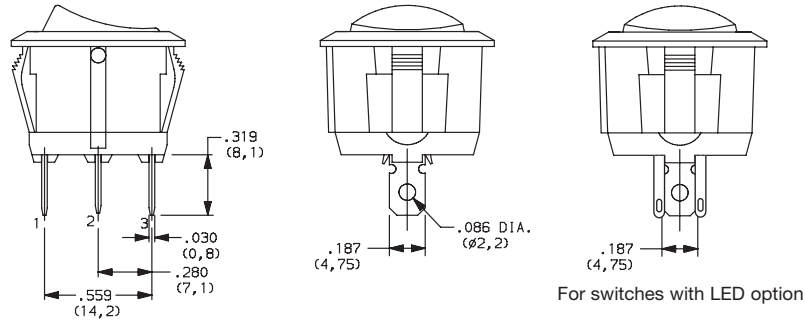

CONTACT MATERIAL



OPTION CODE	CONTACT AND TERMINAL MATERIAL	RATINGS		C _{RU} US
		POWER	16 AMPS @ 125 VAC; 10 AMPS @ 250 VAC	
QF	SILVER			

* Note: See Technical Data section of this catalog for RoHS compliant and compatible definitions and specifications.

LAMP RATING



(NONE) NO LAMP

6 LED RATING @ 10 mA $V_f=1.85V$

7 125 VAC 33kΩ NEON

8 250 VAC 150kΩ NEON

ACCESSORIES

377C00000 IP65 SPLASH PROOF RUBBER BOOT

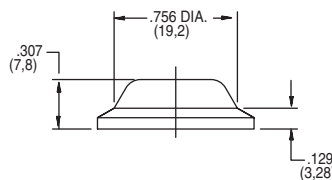
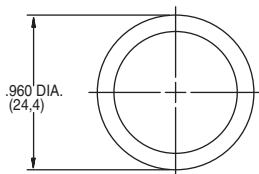

Dimensions are shown: Inches (mm)
Specifications and dimensions subject to change



Features/Benefits

- Various designs up to 16 amps
- Heavy duty and extended life cycles
- SPST, SPDT and DPST options
- Different symbols available

Typical Applications

- Household appliances
- Industrial equipment
- Audio & visual equipment
- Telecommunication
- Office equipment



Specifications

CONTACT RATING: 6.5 Amps @ 125 VAC
 ELECTRICAL LIFE: 6,000 cycles at full load.
 INITIAL CONTACT RESISTANCE: 100m Ω min.
 INSULATION RESISTANCE: 100M Ω min.
 DIELECTRIC STRENGTH: 1,500 VAC (50-60 Hz)
 OPERATING FORCE: ON_OFF: 250 \pm 100 gf
 OFF_ON: 700 \pm 250 gf
 PACKAGING: 300 pieces per bag (5 trays)
 2,400 pieces per box

Materials

HOUSING: PA (UL 94V-2).
 KNOB: PA (UL 94V-2).
 CONTACTS: Silver plated.

NOTE: Specifications and materials listed above are for switches with standard options. For information on specific and custom switches, consult Customer Service Center.

Environmental

OPERATING TEMPERATURE: 0°C to 65°C

PART NUMBER	HOUSING COLOR
SW-13A65N-A01	White
SW-13A65N-A01 BK	Black
SW-11A06N-A02	Black
SW-11A06N-A03 AP	Black
SW-11A06N-B02	Black
SW-11A06N-B02 AP	Black
SW-11A06N-CR02	Black
SW-12A06N-B02	Black
SW-12A06N-F01	Black
SW-12B03N	Black
SW-13A65N-A01 AK	Almond
SW-13A65N-A01 BI	Biscuit

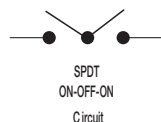
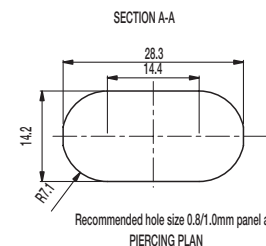
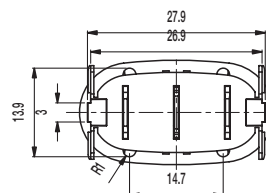
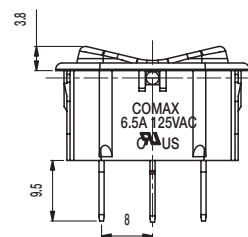
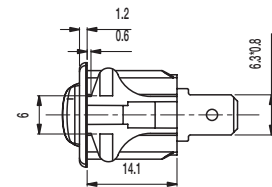
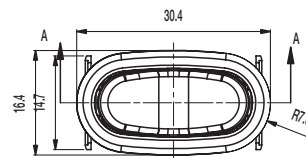

CG Series Single Pole Power Rocker Switches

Features/Benefits

- Bevelled frame
- Illuminated versions available
- Easy panel mount installation

Typical Applications

- Computers and peripherals
- Small appliances
- Instrument panels
- Industrial controls
- RoHS compliant



UL 61058-1

Specifications

CONTACT RATING:
 16 AMPS @ 125 VAC, 10 AMPS @ 250 VAC.
 10 AMPS @ 250 VAC, 6 AMPS @ 250 VAC.
 ELECTRICAL LIFE: 10,000 make and break cycles at full load.
 INSULATION RESISTANCE: $10^8 \Omega$ min.
 DIELECTRIC STRENGTH: 1,500 VRMS @ sea level.
 OPERATING TEMPERATURE: -20°C to +85°C

Materials

HOUSING AND ACTUATOR: 6/6 nylon (UL94V-2), black, matte finish.
 ILLUMINATED ACTUATOR: Polycarbonate, matte finish.
 CENTER CONTACTS: Silver plated, copper alloy.
 END CONTACTS: Silver plated.
 ALL TERMINALS: Silver plated, copper alloy.

NOTE: Specifications and materials listed above are for switches with standard options. For information on specific and custom switches, consult Customer Service Center.

Build-A-Switch

To order, simply select desired option from each category and place in the appropriate box. Available options are shown and described on pages G-87 through G-89. For additional options not shown in catalog, consult Customer Service Center.

<input type="checkbox"/>	<input type="checkbox"/>	<input type="checkbox"/>	<input type="checkbox"/>	<input type="checkbox"/>	<input type="checkbox"/>	<input type="checkbox"/>	<input type="checkbox"/>	<input type="checkbox"/>	<input type="checkbox"/>	<input type="checkbox"/>	<input type="checkbox"/>	<input type="checkbox"/>
Switch Function <input type="checkbox"/> <ul style="list-style-type: none"> CG101 SPDT On-None-On CG102 SPST On-None-Off CG103 SPDT On-Off-On CG105 SPDT Mom-Off-Mom CG12 * SPST On-None-Off 												
Actuator <input type="checkbox"/> <ul style="list-style-type: none"> J1 Rocker J2 **Two-tone rocker J3 Illuminated rocker 												
Actuator Color <input type="checkbox"/> <ul style="list-style-type: none"> 2 Black 1 White 3 Red R Red, illuminated A Amber, illuminated G Green, illuminated 												
Mounting Style/Color <input type="checkbox"/> <ul style="list-style-type: none"> S2 Snap-in, black S1 Snap-in, white 												
Termination <input type="checkbox"/> <ul style="list-style-type: none"> 05 .250" quick connect 												
Actuator Marking <input type="checkbox"/> <ul style="list-style-type: none"> (NONE) No marking D ON-OFF H "O I" - international ON-OFF P "O -" international ON-OFF 												
Contact Rating <input type="checkbox"/> <ul style="list-style-type: none"> QF Silver 												
Lamp Rating <input type="checkbox"/> <ul style="list-style-type: none"> (NONE) No lamp 7 125 VAC neon 8 250 VAC neon 												

* CG12 — for switches with both marking and illumination

** J2 — refer to table on next page for actuator options



CG Series Single Pole Power Rocker Switches

SWITCH FUNCTION



NO. POLES	MODEL NO.	SWITCH FUNCTION			CONNECTED TERMINALS			SCHEMATIC
		Pos. 1	Pos. 2	Pos. 3	Pos. 1	Pos. 2	Pos. 3	
		C&K marking on opposite side			C&K marking on opposite side			
SP	CG101	ON	NONE	ON	1-2		2-3	
	CG102	ON	NONE	OFF	1-2	N/A	OPEN	 OR For Illuminated Version
	CG103	ON	OFF	ON	1-2	OPEN	2-3	
	CG105	MOM	OFF	MOM	1-2	OPEN	2-3	
	CG12 *	ON	NONE	OFF	1-2	N/A	OPEN	

* CG12 - for switches with both marking and illumination

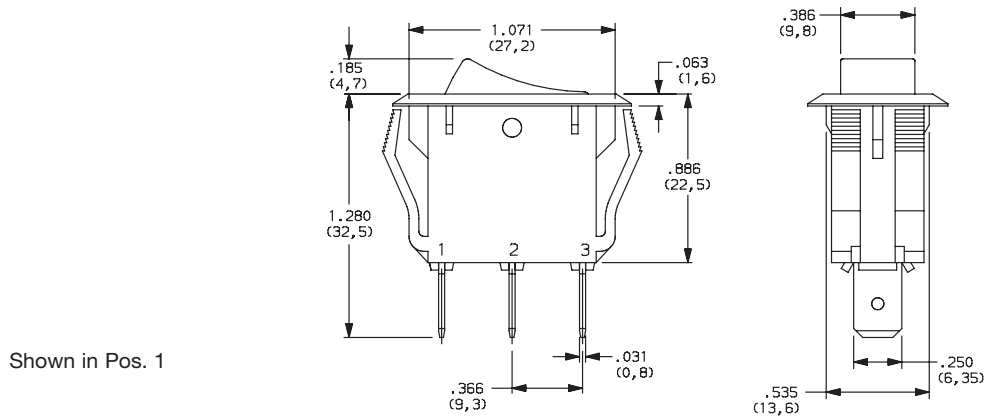

ACTUATOR

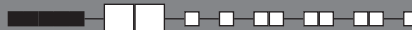

- J1** ROCKER
- J3** ILLUMINATED ROCKER

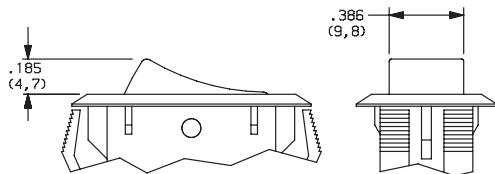

NOTE: J3 actuator available with CG102 switch function only.

- J2** TWO-TONE ROCKER

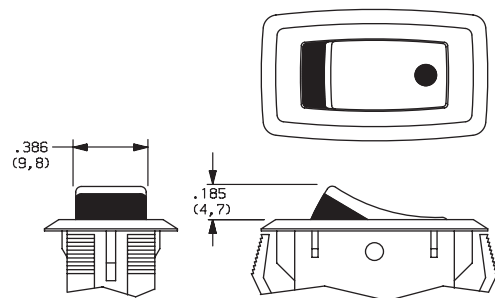

NOTE: Available with CG102 switch function only.

Rocker



Dimensions are shown: Inches (mm)
Specifications and dimensions subject to change



CG Series Single Pole Power Rocker Switches

ACTUATOR COLOR

ACTUATOR	OPTION CODE	ACTUATOR COLOR
J1	2	BLACK
	1	WHITE
	3	RED
J3	R	RED, ILLUMINATED
	A	AMBER, ILLUMINATED
	G	GREEN, ILLUMINATED

OPTION CODE	ACTUATOR COLOR	
	TOP	BOTTOM
1	WHITE	RED
2	WHITE	BLACK
3	RED	WHITE
4	BLACK	WHITE
5	BLACK	RED

J2 actuator only

MOUNTING STYLE/COLOR

S2 SNAP-IN, BLACK

S1 SNAP-IN, WHITE

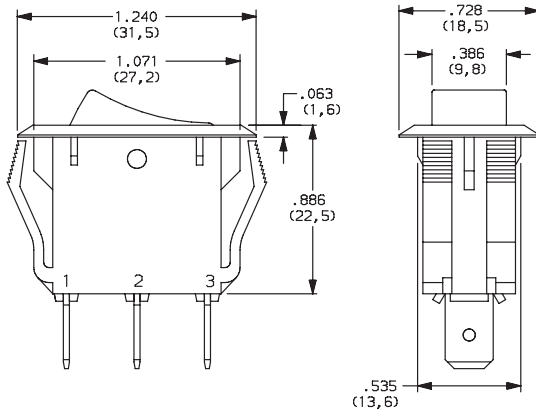

Shown in Pos. 1

PANEL MOUNTING

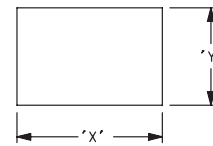

PANEL THICKNESS	"X"	"Y"
0.030-0.049 (0,75-1,25)	1.087-.004 (27,6-0,1)	0.543+.004 (13,8+0,1)
0.049-0.079 (1,25-2,0)	1.094-.004 (27,8-0,1)	0.543+.004 (13,8+0,1)
0.079-0.118 (2,0-3,0)	1.102-.004 (28,0-0,1)	0.543+.004 (13,8+0,1)

TERMINATION

05 .250" QUICK CONNECT

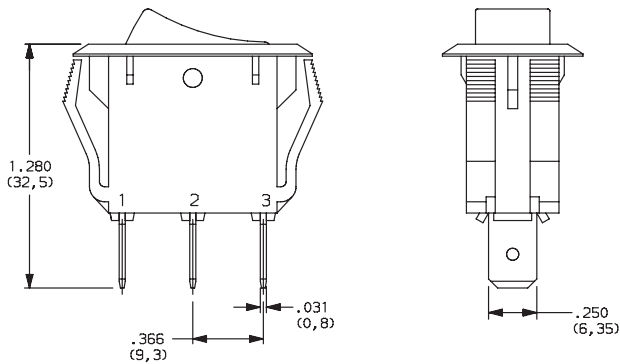

Shown in Pos. 1

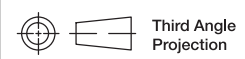

CG Series Single Pole Power Rocker Switches

ACTUATOR MARKING



NONE NO MARKING



D ON-OFF



H 01

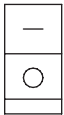

P 0-

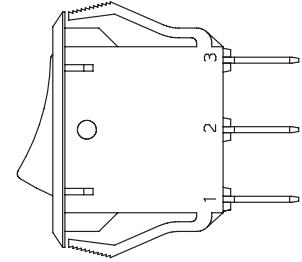
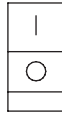

NOTE: Orientation of actuator marking and terminals.

Shown in Pos. 1

CONTACT MATERIAL



OPTION CODE	CONTACT AND TERMINAL MATERIAL	RATINGS	
QF	SILVER	POWER	16 AMPS @ 125 VAC; 10 AMPS @ 250 VAC 10 AMPS @ 250 VAC

* Note: See Technical Data section of this catalog for RoHS compliant and compatible definitions and specifications.



LAMP RATING



(NONE) NO LAMP

7 125 VAC 33kΩ NEON

8 250 VAC 150kΩ NEON

NOTE: Lamp rating for J3 actuator option.

Rocker



G

C&K

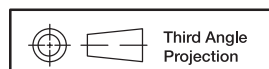

Dimensions are shown: Inches (mm)
Specifications and dimensions subject to change

CL Series Single Pole Power Rocker Switches

Features/Benefits

- Illuminated versions available
- Positive detent
- Snap-in mounting

Typical Applications

- Floor care products
- Power outlet strips
- HVAC units
- RoHS compliant

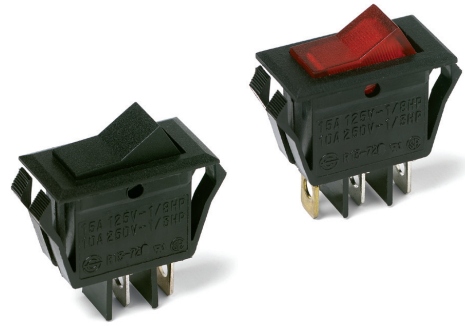

Specifications

CONTACT RATING:

- 16 AMPS @ 125 VAC, 1/3 HP;
- 10 AMPS @ 250 VAC, 1/2 HP.

ELECTRICAL LIFE: 10,000 make and break cycles at full load.

INSULATION RESISTANCE: $10^8 \Omega$ min.

DIELECTRIC STRENGTH: 1,500 VRMS @ sea level.

OPERATING TEMPERATURE: -20°C to +80°C

Materials

HOUSING AND ACTUATOR: 6/6 nylon (UL94V-2), black, matte finish.

ILLUMINATED ACTUATOR: Polycarbonate, matte finish.

CENTER CONTACTS: Silver plated, copper alloy.

END CONTACTS: Silver plated.

ALL TERMINALS: Silver plated, copper alloy.

NOTE: Specifications and materials listed above are for switches with standard options. For information on specific and custom switches, consult Customer Service Center.

Build-A-Switch

To order, simply select desired option from each category and place in the appropriate box. Available options are shown and described on pages G-91 through G-93. For additional options not shown in catalog, consult Customer Service Center.

<input type="checkbox"/> <input type="checkbox"/> <input type="checkbox"/> <input type="checkbox"/> <input type="checkbox"/> <input type="checkbox"/> <input type="checkbox"/> <input type="checkbox"/> <input type="checkbox"/> <input type="checkbox"/> <input type="checkbox"/> <input type="checkbox"/> <input type="checkbox"/> <input type="checkbox"/> <input type="checkbox"/> <input type="checkbox"/> <input type="checkbox"/> <input type="checkbox"/> <input type="checkbox"/> <input type="checkbox"/>	
Switch Function	
CL101 SPDT On-None-On CL102 SPST On-None-Off CL12* SPST On-None-Off	
Actuator	
J7 Rocker J9 Illuminated rocker	
Actuator Color	
2 Black 1 White 3 Red R Red, illuminated A Amber, illuminated G Green, illuminated	
Mounting Style/Color	
S2 Snap-in, black S1 Snap-in, white	
Termination	
05 .250" quick connect	
Actuator Marking	
(NONE) No marking D ON-OFF H "O I" - international ON-OFF P "O -" international ON-OFF	
Contact Rating	
QA Silver	
Lamp Rating	
(NONE) No lamp 7 125 VAC neon 8 250 VAC neon	

* CL12 - for switches with both marking and illumination



Dimensions are shown: Inches (mm)
Specifications and dimensions subject to change



CL Series Single Pole Power Rocker Switches

SWITCH FUNCTION



NO. POLES	MODEL NO.	SWITCH FUNCTION			CONNECTED TERMINALS			SCHEMATIC
		Pos. 1	Pos. 2	Pos. 3	Pos. 1	Pos. 2	Pos. 3	
		C&K marking on opposite side			C&K marking on opposite side			
SP	CL101	ON	NONE	ON	2-1	N/A	2-3	
	CL102	ON	NONE	OFF	2-1		OPEN	 For Illuminated Version
	CL12 *	ON	NONE	OFF				

* CL12 - for switches with both marking and illumination

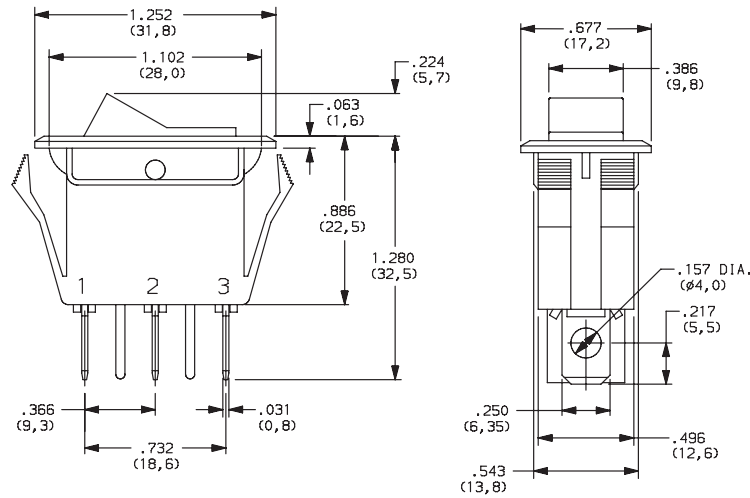

Shown in Pos. 1

ACTUATOR

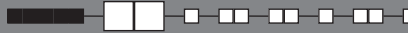

J7 ROCKER

J9 ILLUMINATED ROCKER

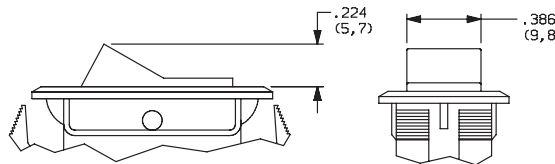

NOTE: J9 actuator available with CL102 & CL12 switch function only.

ACTUATOR COLOR



OPTION CODE	ACTUATOR COLOR
2	BLACK
1	WHITE
3	RED
R	RED, ILLUMINATED
A	AMBER, ILLUMINATED
G	GREEN, ILLUMINATED

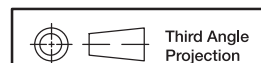

Third Angle Projection

Dimensions are shown: Inches (mm)
Specifications and dimensions subject to change

Rocker



G

C&K

CL Series Single Pole Power Rocker Switches

MOUNTING STYLE/COLOR



S2 SNAP-IN, BLACK

S1 SNAP-IN, WHITE

PANEL MOUNTING

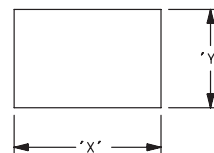

PANEL THICKNESS	"X"	"Y"
0.030-0.049 (0,75-1,25)	1.126-.004 (28,6-0,1)	0.551+.004 (14,0+0,1)
0.049-0.079 (1,25-2,0)	1.134-.004 (28,8-0,1)	0.551+.004 (14,0+0,1)
0.079-0.118 (2,0-3,0)	1.150-.004 (29,2-0,1)	0.551+.004 (14,0+0,1)

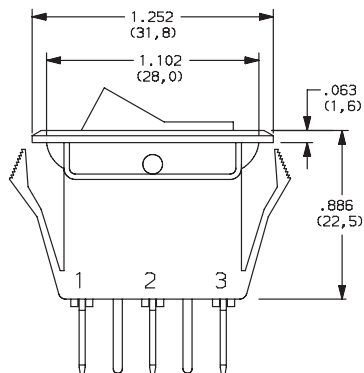

Shown in Pos. 1

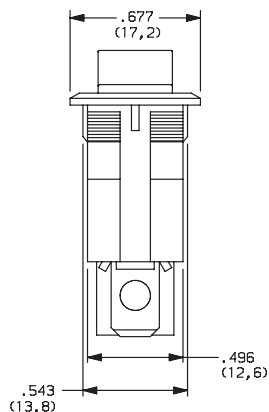

TERMINATION



05 .250" QUICK CONNECT

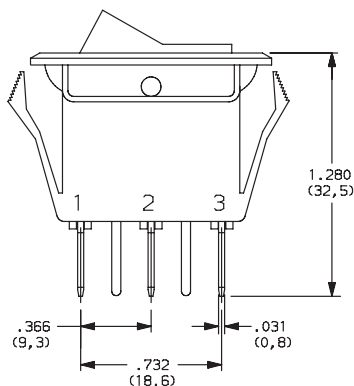

Shown in Pos. 1

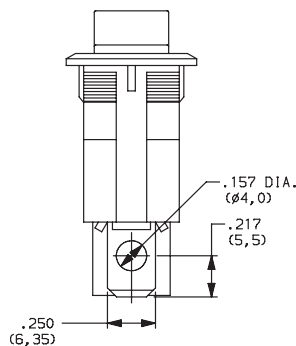

ACTUATOR MARKING



NONE NO MARKING

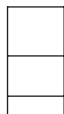

D ON-OFF



H 0 I

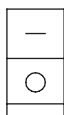

P 0 -

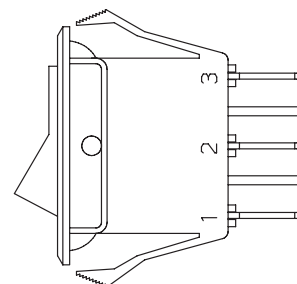

NOTE: Orientation of actuator marking and terminals.

Shown in Pos. 1

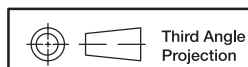

Dimensions are shown: Inches (mm)
Specifications and dimensions subject to change



CL Series Single Pole Power Rocker Switches

CONTACT MATERIAL



OPTION CODE	CONTACT AND TERMINAL MATERIAL	RATINGS	
		QA	SILVER

* Note: See Technical Data section of this catalog for RoHS compliant and compatible definitions and specifications.



LAMP RATING



(NONE) NO LAMP

7 125 VAC 33kΩ NEON

8 250 VAC 150kΩ NEON

NOTE: Lamp rating for J9 actuator option.

Rocker



G



Dimensions are shown: Inches (mm)
Specifications and dimensions subject to change

CM Series Single Pole Power Rocker Switches

Features/Benefits

- Illuminated versions available
- Easy to install snap-in design
- Multiple actuator and termination styles to choose from

Typical Applications

- Computers and peripherals
- Power supplies
- Industrial equipment
- Small appliances
- RoHS compliant



Specifications

CONTACT RATING:

- 16 AMPS @ 125 VAC, 1/8 HP;
- 10 AMPS @ 250 VAC, 1/3 HP.

ELECTRICAL LIFE: 10,000 make and break cycles at full load.

INSULATION RESISTANCE: $10^8 \Omega$ min.

DIELECTRIC STRENGTH: 1,500 VRMS @ sea level.

OPERATING TEMPERATURE: -20°C to +80°C

Materials

HOUSING AND ACTUATOR: 6/6 nylon (UL94V-2), black, gloss or matte finish.

ILLUMINATED ACTUATOR: Polycarbonate, gloss or matte finish.

CENTER CONTACTS: Silver plated, copper alloy.

END CONTACTS: Silver plated.

ALL TERMINALS: Silver plated, copper alloy.

NOTE: Specifications and materials listed above are for switches with standard options. For information on specific and custom switches, consult Customer Service Center.

Build-A-Switch

To order, simply select desired option from each category and place in the appropriate box. Available options are shown and described on pages G-95 through G-97. For additional options not shown in catalog, consult Customer Service Center.

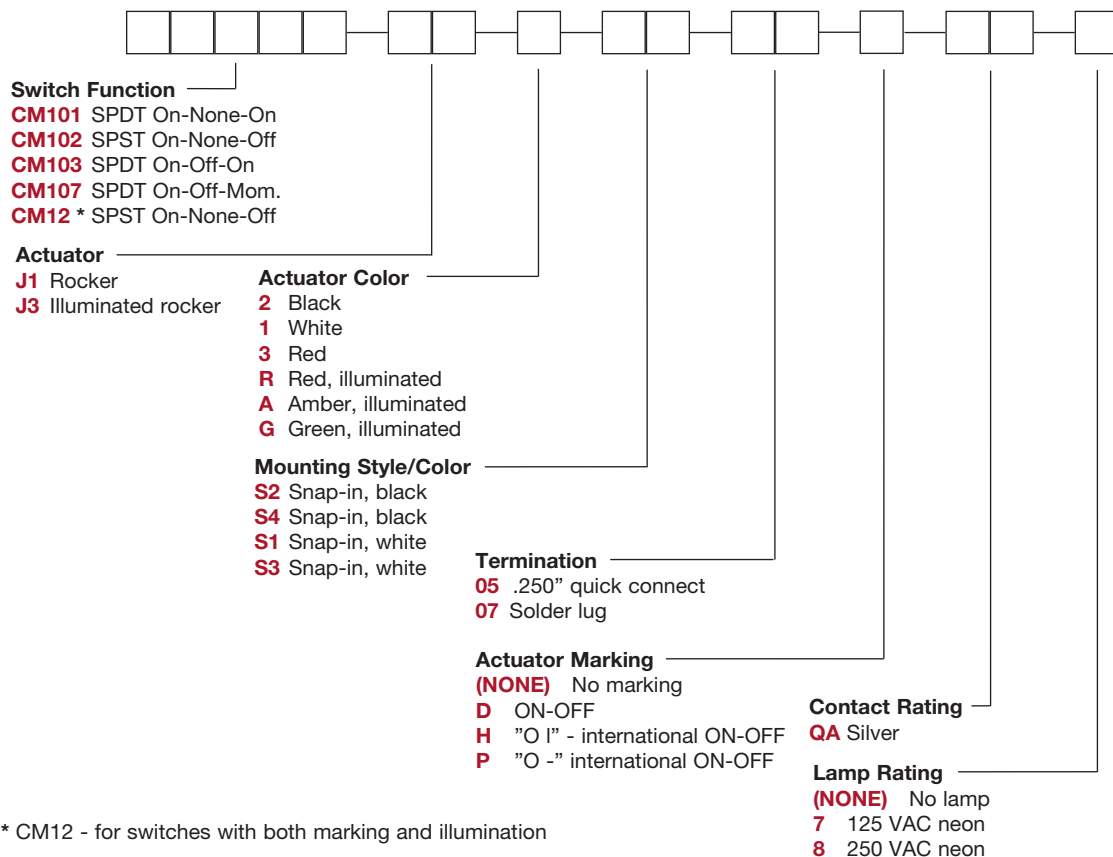

* CM12 - for switches with both marking and illumination



CM Series Single Pole Power Rocker Switches

SWITCH FUNCTION



NO. POLES	MODEL NO.	SWITCH FUNCTION			CONNECTED TERMINALS			SCHEMATIC
		Pos. 1	Pos. 2	Pos. 3	Pos. 1	Pos. 2	Pos. 3	
SP	CM101	ON	NONE	ON			2-3	
	CM102	ON	NONE	OFF			OPEN	 OR For Illuminated Version
	CM103	ON	OFF	ON	2-1			
	CM107	ON	OFF	MOM.			2-3	
	CM12 *	ON	NONE	OFF			OPEN	

* CM12 - for switches with both marking and illumination

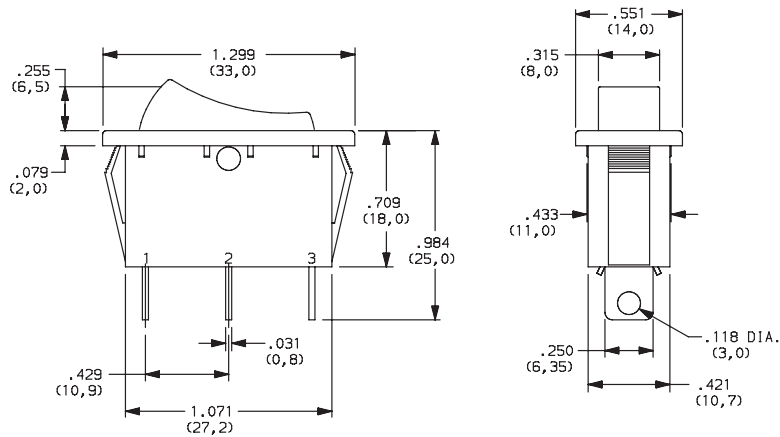

Shown in Pos. 1

ACTUATOR

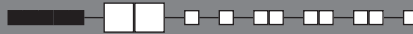

J1 ROCKER

J3 ILLUMINATED ROCKER

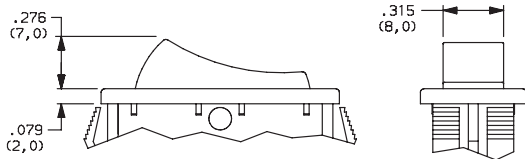

NOTE: J3 actuator available with CM102 & CM12 switch function only.

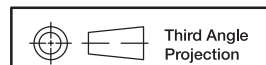

Third Angle
Projection

Dimensions are shown: Inches (mm)
Specifications and dimensions subject to change

CM Series Single Pole Power Rocker Switches

ACTUATOR COLOR



OPTION CODE	ACTUATOR COLOR
2	BLACK
1	WHITE
3	RED
R	RED, ILLUMINATED
A	AMBER, ILLUMINATED
G	GREEN, ILLUMINATED

MOUNTING STYLE/COLOR



S2 SNAP-IN, BLACK

S4 SNAP-IN, BLACK (SHORT FRAME)

S1 SNAP-IN, WHITE

S3 SNAP-IN, WHITE

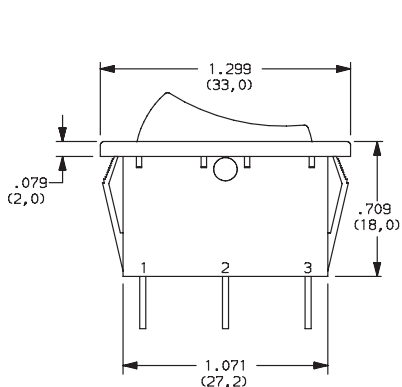

Shown in Pos. 1

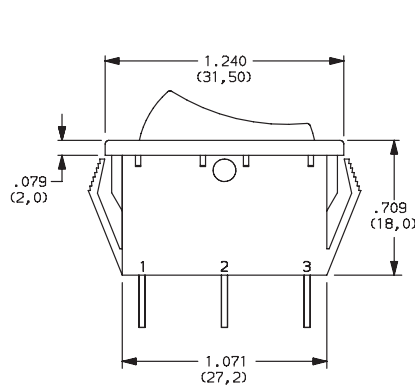
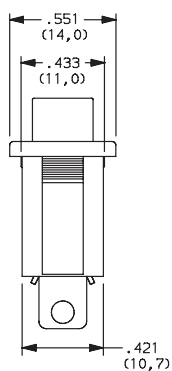

Shown in Pos. 1

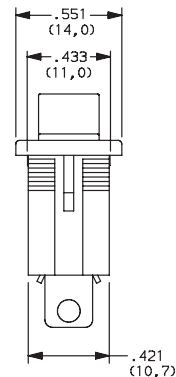

PANEL MOUNTING

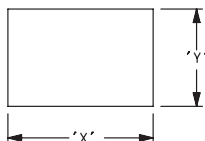

PANEL THICKNESS	"X"	"Y"
0.030-0.049 (0,75-1,25)	1.189-.004 (30,2-0,1)	0.441+.004 (11,2+0,1)
0.049-0.079 (1,25-2,0)	1.197-.004 (30,4-0,1)	0.441+.004 (11,2+0,1)
0.079-0.118 (2,0-3,0)	1.212-.004 (30,8-0,1)	0.441+.004 (11,2+0,1)

TERMINATION



05 .250 QUICK CONNECT

07 SOLDER LUG

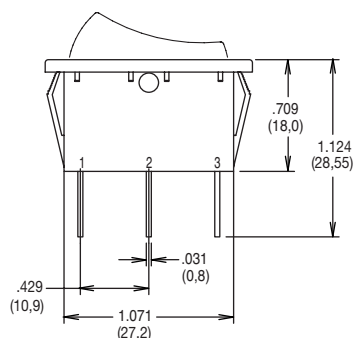

Shown in Pos. 1

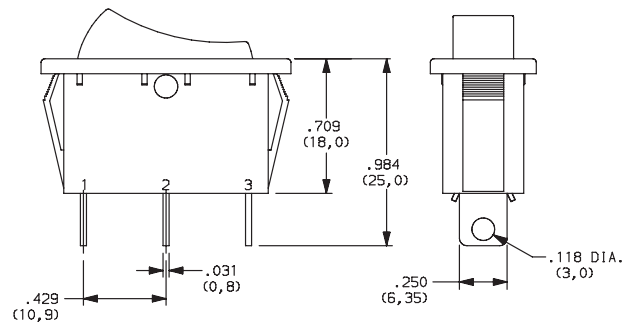
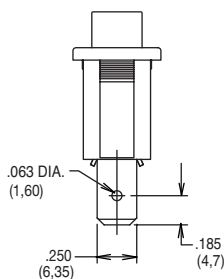

NOTE: Available with CM101 & CM102 switch functions only.

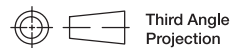

Dimensions are shown: Inches (mm)
Specifications and dimensions subject to change



16 May 18



CM Series Single Pole Power Rocker Switches

ACTUATOR MARKING



NONE NO MARKING

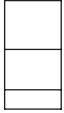

D ON-OFF



H 0 I

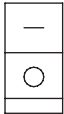

P 0 -

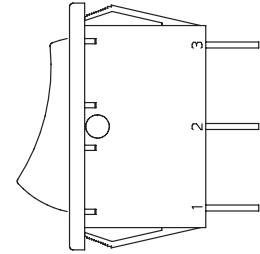

NOTE: Orientation of actuator marking and terminals.

Shown in Pos. 1

CONTACT MATERIAL



OPTION CODE	CONTACT AND TERMINAL MATERIAL	RATINGS	
		QA	SILVER

* Note: See Technical Data section of this catalog for RoHS compliant and compatible definitions and specifications.



LAMP RATING



(NONE) NO LAMP

7 125 VAC 33kΩ NEON

8 250 VAC 150kΩ NEON

NOTE: Lamp rating for J3 & J8 actuator option.

Rocker



G

C&K

16 May 18

G-94



Dimensions are shown: Inches (mm)
Specifications and dimensions subject to change

www.ckswitches.com

CN Series Double Pole Power Rocker Switches

Features/Benefits

- Illuminated versions available
- Multiple actuator and termination styles
- Robust design
- Custom version upon request
- RoHS compliant



Typical Applications

- Appliances
- Office equipment
- Computers and peripherals
- Off-road vehicles
- Industrial machines
- HVAC units
- Transportation

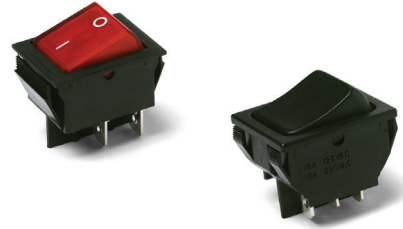

Specifications

CONTACT RATING:

See table for Q and QA ratings on the last page of this series.

ELECTRICAL LIFE: 10,000 make and break cycles at full load.

INSULATION RESISTANCE: 10⁸ Ω min.

DIELECTRIC STRENGTH: 1,500 VRMS @ sea level.

OPERATING TEMPERATURE: -20°C to +85°C

HOUSING AND ACTUATOR: 6/6 nylon (UL94V-2), black, matte finish.

ILLUMINATED ACTUATOR: Polycarbonate, matte finish.

CENTER CONTACTS: Silver plated, copper alloy.

END CONTACTS: Silver plated Ag₂SuO₂InO₃.

ALL TERMINALS: Silver plated, copper alloy.

Note: Specifications and materials listed above are for switches with standard options. For information on specific and custom switches, consult Customer Service Center.

Materials

Build-A-Switch

To order, simply select desired option from each category and place in the appropriate box. Available options are shown and described on pages G-99 through G-101. For additional options not shown in catalog, consult Customer Service Center.

<div style="border: 1px solid black; width: 100px; height: 15px; display: inline-block;"></div>		<div style="border: 1px solid black; width: 30px; height: 15px; display: inline-block;"></div>		<div style="border: 1px solid black; width: 20px; height: 15px; display: inline-block;"></div>		<div style="border: 1px solid black; width: 30px; height: 15px; display: inline-block;"></div>		<div style="border: 1px solid black; width: 30px; height: 15px; display: inline-block;"></div>		<div style="border: 1px solid black; width: 30px; height: 15px; display: inline-block;"></div>		<div style="border: 1px solid black; width: 30px; height: 15px; display: inline-block;"></div>		<div style="border: 1px solid black; width: 30px; height: 15px; display: inline-block;"></div>	
Switch Function		Actuator Color		Mounting Style/Color		Termination		Actuator Marking		Contact Rating		Lamp Rating			
CN201 DPDT On-None-On CN202 DPST On-None-Off CN22 * DPST On-None-Off		2 Black 1 White 3 Red R Red, illuminated A Amber, illuminated G Green, illuminated		S2 Snap-in, black S4 Snap-in, black S1 Snap-in, white S3 Snap-in, white		15 .187" quick connect 05 .250" quick connect		(NONE) No marking D ON-OFF H "O I" - international ON-OFF P "O -" international ON-OFF		Q Silver QA Silver (with HP rating)		(NONE) No lamp 7 125 VAC neon 8 250 VAC neon			

* CN22 - for switches with both marking and illumination

Rocker



Dimensions are shown: Inches (mm)
Specifications and dimensions subject to change



CN Series Double Pole Power Rocker Switches

SWITCH FUNCTION



NO. POLES	MODEL NO.	SWITCH FUNCTION			CONNECTED TERMINALS			SCHEMATIC	
		Pos. 1	Pos. 2	Pos. 3	Pos. 1	Pos. 2	Pos. 3		
		C&K marking on opposite side			C&K marking on opposite side				
DP	CN201	ON	NONE	ON	2-1 4-5	N/A	2-3 6-5		
	CN202	ON	NONE	OFF				OPEN	
	CN22 *	ON	NONE	OFF					

* CN22 - for switches with both marking and illumination

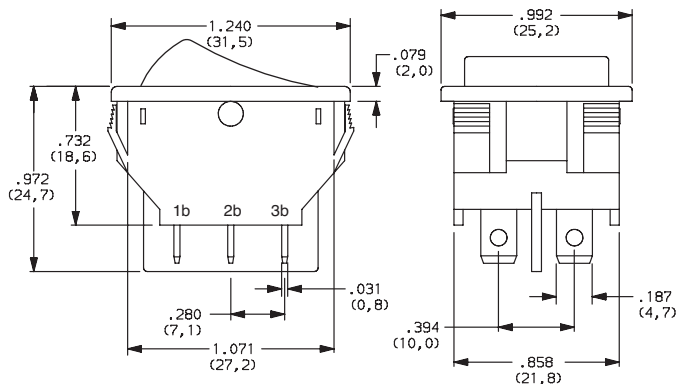

Shown in Pos. 1

ACTUATOR

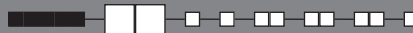

- J1** ROCKER
- J3** ILLUMINATED ROCKER

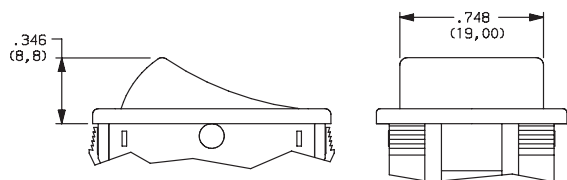

NOTE: J1 & J3 actuators available with Q contact rating only.
 J3 actuator available with CN202 & CN22 switch function only.

- J6** ROCKER
- J8** ILLUMINATED ROCKER

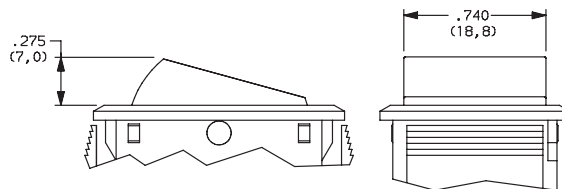

NOTE: J6 & J8 actuators available with QA contact rating only.
 J6 actuator available with CN201 & CN202 switch functions,
 J8 actuator available with CN202 & CN22 switch function only.

Rocker

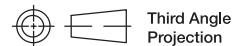

Third Angle
Projection

Dimensions are shown: Inches (mm)
 Specifications and dimensions subject to change



CN Series Double Pole Power Rocker Switches

ACTUATOR COLOR

OPTION CODE	ACTUATOR COLOR
2	BLACK
1	WHITE
3	RED
R	RED, ILLUMINATED
A	AMBER, ILLUMINATED
G	GREEN, ILLUMINATED

MOUNTING STYLE/COLOR

S2 SNAP-IN, BLACK

S1 SNAP-IN, WHITE

S4 SNAP-IN, BLACK

S3 SNAP-IN, WHITE

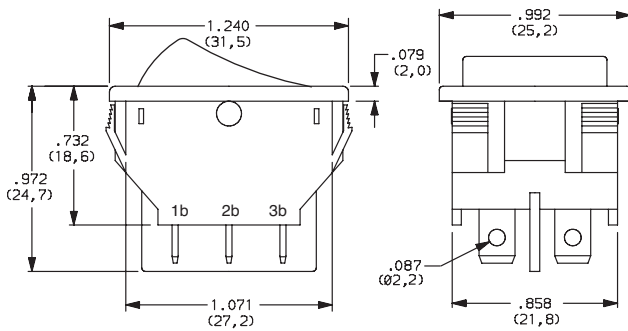

NOTE: Available with 15 termination and Q contact rating only.

Shown in Pos. 1

PANEL MOUNTING

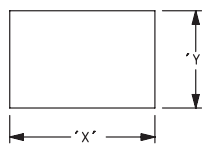

NOTE: Available with 05 termination and QA contact rating only.

Shown in Pos. 1

PANEL THICKNESS	"X"	"Y"
0.030-0.049 (0,75-1,25)	1.190-.004 (30,2-0,1)	0.874+.004 (22,2+0,1)
0.049-0.079 (1,25-2,0)	1.197-.004 (30,4-0,1)	0.874+.004 (22,2+0,1)
0.079-0.118 (2,0-3,0)	1.213-.004 (30,8-0,1)	0.874+.004 (22,2+0,1)

TERMINATION

15 .187" QUICK CONNECT

05 .250" QUICK CONNECT

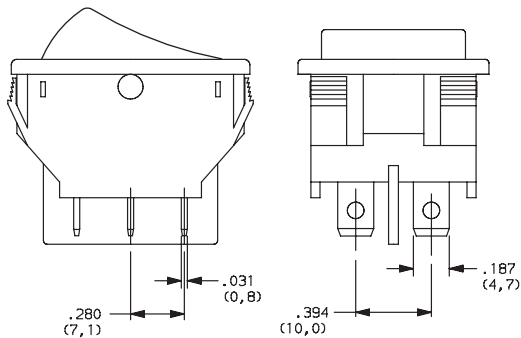

NOTE: Available with S1 & S2 mounting style and Q contact rating only.

Shown in Pos. 1

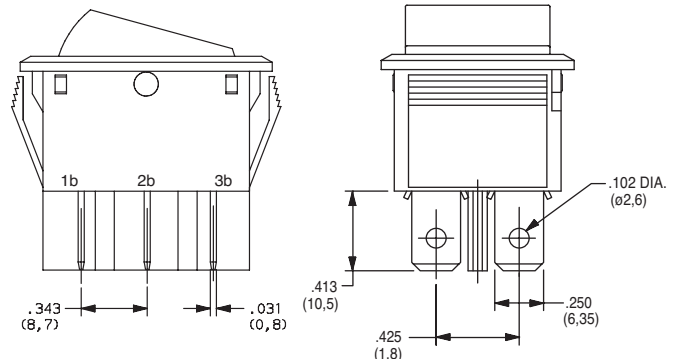

NOTE: Available with S3 & S4 mounting styles and QA contact rating, CN201 & CN202 switch functions only.

Shown in Pos. 1



Dimensions are shown: Inches (mm)
Specifications and dimensions subject to change

C&K

CN Series Double Pole Power Rocker Switches

ACTUATOR MARKING

NONE NO MARKING

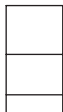

D ON-OFF

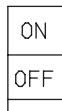

H O-I

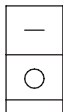

P O-

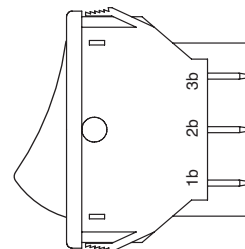

NOTE: Orientation of actuator marking and terminals.
Shown in Pos. 1

CONTACT MATERIAL

OPTION CODE	CONTACT AND TERMINAL MATERIAL	RATINGS	
Q	SILVER	POWER	16A @ 125C 1/3 HP @ 125 V AC
QA			10A @ 250 V AC 1/2HP @ 250 V AC
			16A @ 125 VAC, 1/8 HP @ 125 V AC; 10 A @ 250 VAC, 1/3 HP @ 250 V AC

* Note: See Technical Data section of this catalog for RoHS compliant and compatible definitions and specifications.



LAMP RATING

(NONE) NO LAMP

7 125 VAC 33kΩ NEON

8 250 VAC 150kΩ NEON

NOTE: Lamp rating for J3 & J8 actuator options.

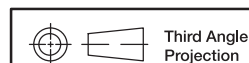

Dimensions are shown: Inches (mm)
Specifications and dimensions subject to change

CA Series Power Rocker Switches

Features/Benefits

- 15 AMPS @ 125 V AC
- Cosmetic slimline detail
- Positive detent

Typical Applications

- Hair dryers and other small appliances
- HVAC and other large appliances
- RoHS compliant

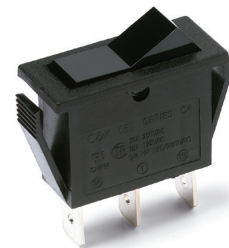

Specifications

CONTACT RATING: 15 AMPS @ 125 V AC;
10 AMPS @ 250 V AC;
1/4 HP @ 125 V AC or 250 V AC

ELECTRICAL LIFE: 10,000 make-and-break cycles at full load.

INSULATION RESISTANCE: $10^9 \Omega$ min.

DIELECTRIC STRENGTH: 1,000 Vrms min. @ sea level.

OPERATING TEMPERATURE: -30°C to +65°C

Materials

HOUSING: 6/6 nylon (UL 94V-2), black.

ACTUATOR: Polycarbonate (UL 94V-2), black.

CONTACTS: Coin silver, silver plated.

TERMINALS: Copper, silver plated.

CONTACT SPRING: Music wire.

NOTE: Specifications and material listed above are for switches with standard options. For information on specific and custom switches, consult Customer Service Center.

Build-A-Switch

To order, simply select desired option from each category and place in the appropriate box. Available options are shown and described on pages G-106 through G-108. For additional options not shown in catalog, consult Customer Service Center.

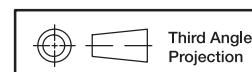
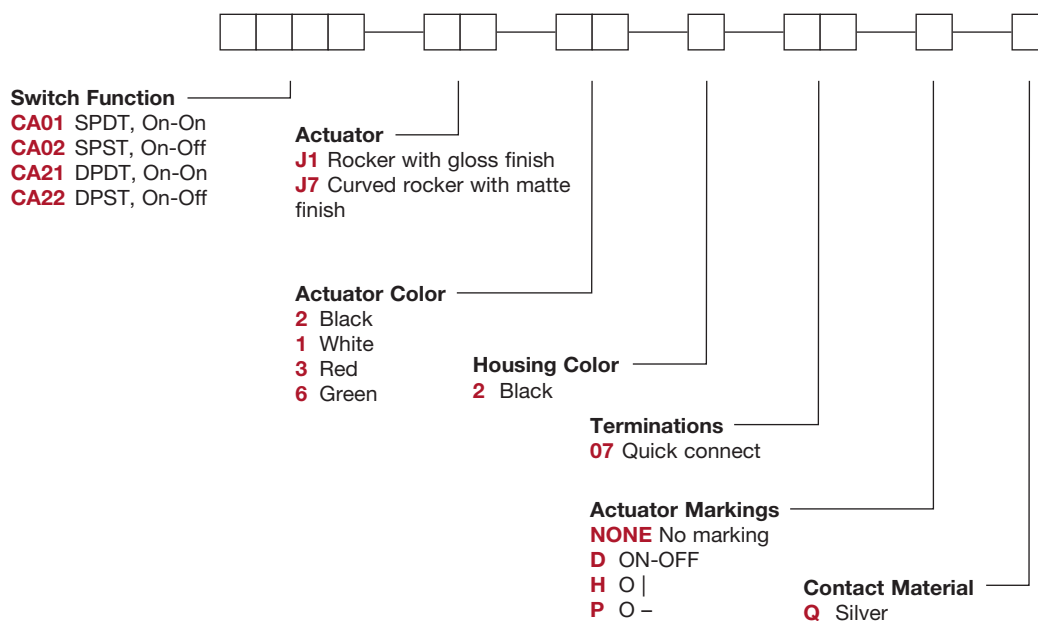

Dimensions are shown: Inches (mm)
Specifications and dimensions subject to change



CA Series Power Rocker Switches

SWITCH FUNCTION



NO. POLES	MODEL NO.	SWITCH FUNCTION		CONNECTED TERMINALS		SCHEMATIC
		POS. 1	POS. 2	POS. 1	POS. 2	
SP	CA01	ON	ON	1-1A	1-1B	SPDT
	CA02	ON	OFF	1-1A	OPEN	SPST

SPST

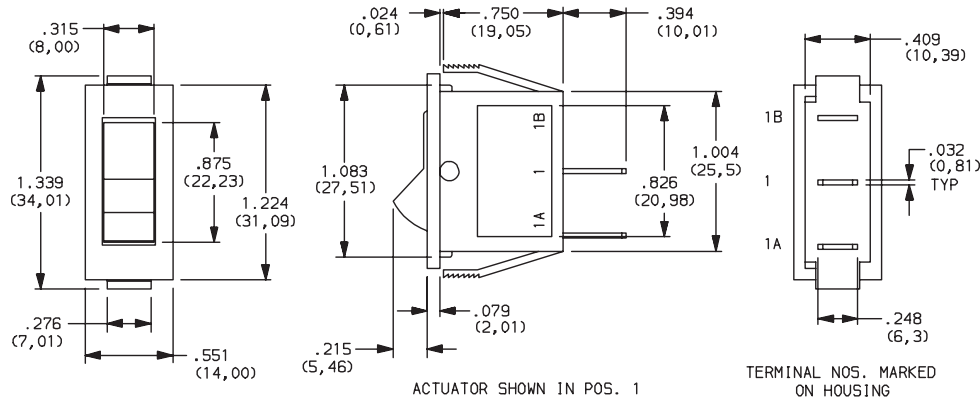

NO. POLES	MODEL NO.	SWITCH FUNCTION		CONNECTED TERMINALS		SCHEMATIC
		POS. 1	POS. 2	POS. 1	POS. 2	
DP	CA21	ON	ON	1-1A, 2-2A	1-1B, 2-2B	DPDT
	CA22	ON	OFF	1-1A, 2-2A	OPEN	DPST

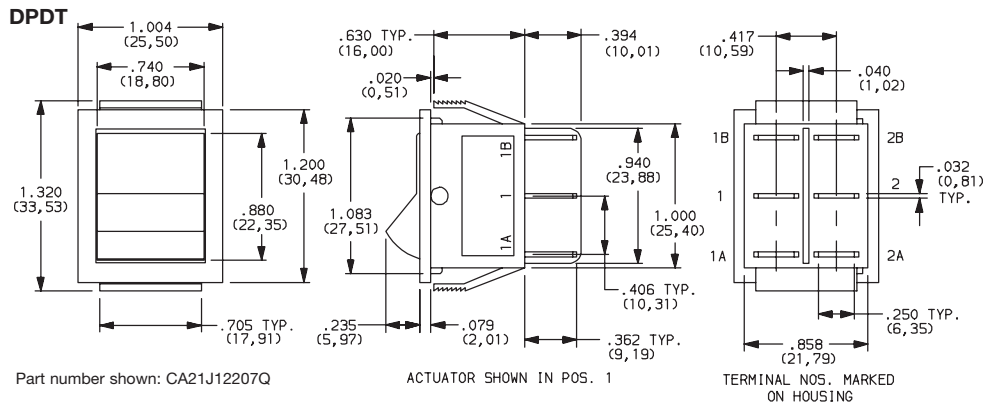

For complete contact ratings and agency approvals, see CONTACT MATERIAL section, page G-108.
Contacts make on side opposite actuator thrown.

All models cRU US with all options.

Rocker



Third Angle
Projection

Dimensions are shown: Inches (mm)
Specifications and dimensions subject to change



CA Series Power Rocker Switches

ACTUATOR



J1 ROCKER WITH GLOSS FINISH

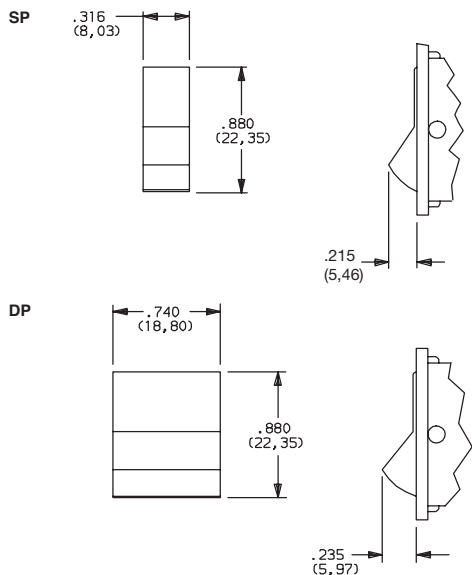

J7 CURVED ROCKER WITH MATTE FINISH

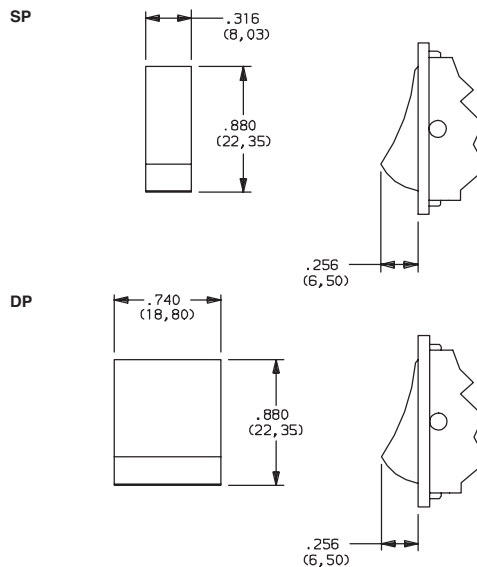

ACTUATOR COLOR



OPTION CODE	OPAQUE ACTUATOR COLOR
1	WHITE
2	BLACK
3	RED
6	GREEN

NOTE: Actuator finish: matte. Special colors available, consult Customer Service Center.

HOUSING COLOR



OPTION CODE	HOUSING COLOR
2	BLACK

NOTE: Housing frame finish: matte.

TERMINATIONS

07 QUICK CONNECT

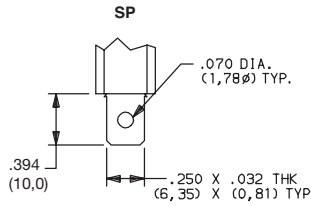

PANEL MOUNTING

J1, & J7 only

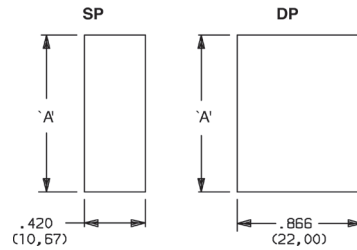

PANEL THICKNESS	DIM 'A'
.059-.078 (1,50) (2,00)	1.102 (28,00)
.078-.118 (2,00) (3,00)	1.110 (28,20)
.118-.177 (3,00) (4,50)	1.126 (28,60)

ACTUATOR MARKINGS

NONE NO MARKING



D ON-OFF

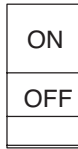

H O |



P O -

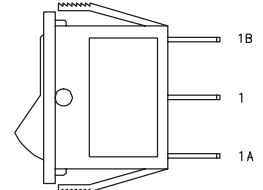

Marking color white, standard for all actuator colors except white and yellow. Marking color black, standard for white and yellow actuators. Consult Customer Service Center for other available markings and colors.

NOTE: Orientation of actuator markings and terminals

CONTACT MATERIAL

OPTION CODE	CONTACT AND TERMINAL MATERIAL	RATINGS		
Q	SILVER ¹	POWER	10 AMPS @ 250 VAC 15 AMPS @ 125 VAC 1/4 HP 125/250 VAC	

* Note: See Technical Data section of this catalog for RoHS compliant and compatible definitions and specifications.

¹ CONTACTS: Coin silver, silver plated.
TERMINALS: Copper, silver plated.

All models with all options.

CA Series Illuminated Power Rocker Switches

Features/Benefits

- 15 AMPS @ 125 V AC
- Illuminated actuator
- Various actuator styles

Typical Applications

- Power outlet strips
- Appliances
- Handling and packaging machines
- RoHS compliant



Specifications

CONTACT RATING: 15 AMPS @ 125 V AC; 10 AMPS @ 250 V AC; 1/4 HP @ 125 V AC or 250 V AC.

ELECTRICAL LIFE: 10,000 make-and-break cycles at full load.

LAMP LIFE: 20,000 hours typ.

INSULATION RESISTANCE: $10^9 \Omega$ min.

DIELECTRIC STRENGTH: 1,000 Vrms min. @ sea level.

Materials

HOUSING: 6/6 nylon (UL 94V-2), black.

ACTUATOR: Polycarbonate (UL 94V-2), red.

CONTACTS: Coin silver, silver plated.

OPERATING TEMPERATURE: -30°C to +65°C

NOTE: Specifications and materials listed above are for switches with standard options. For information on specific and custom switches, consult Customer Service Center.

Build-A-Switch

To order, simply select desired option from each category and place in the appropriate box. Available options are shown and described on pages G-103 through G-105. For additional options not shown in catalog, consult Customer Service Center.

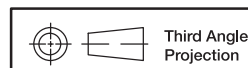
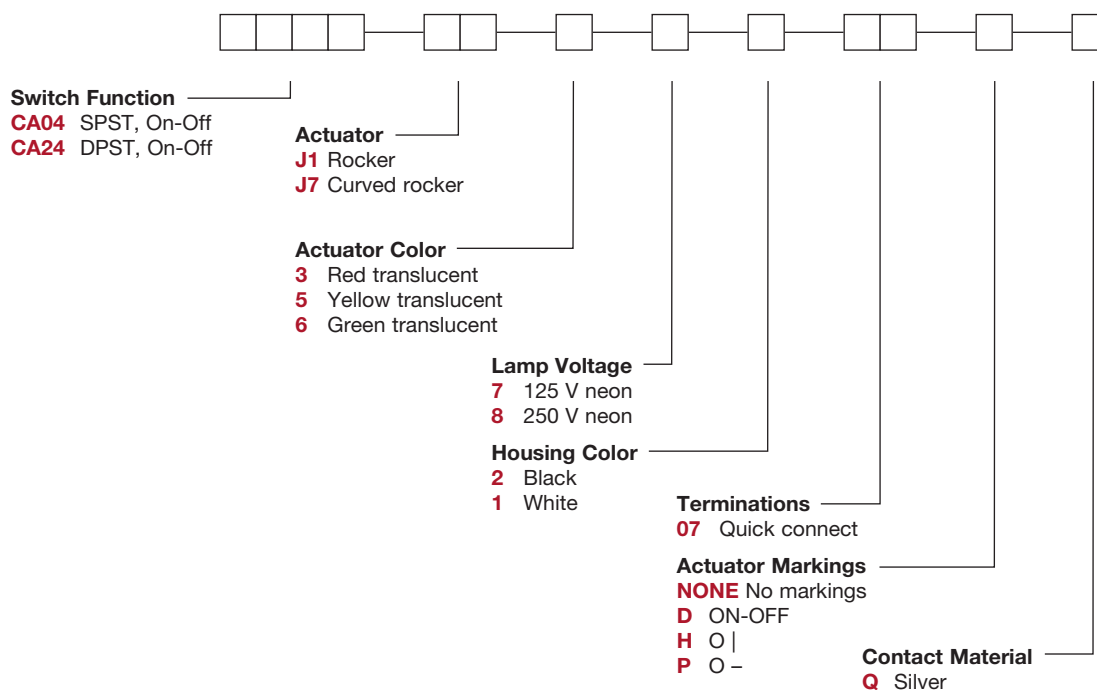

Dimensions are shown: Inches (mm)
Specifications and dimensions subject to change



CA Series Illuminated Power Rocker Switches

SWITCH FUNCTION

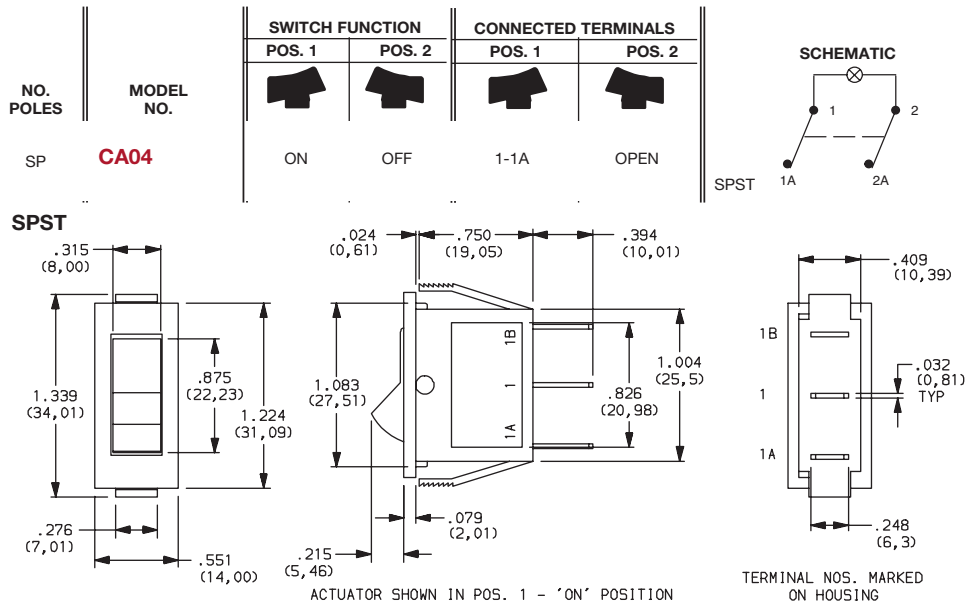

Part number shown: CA04J137207Q

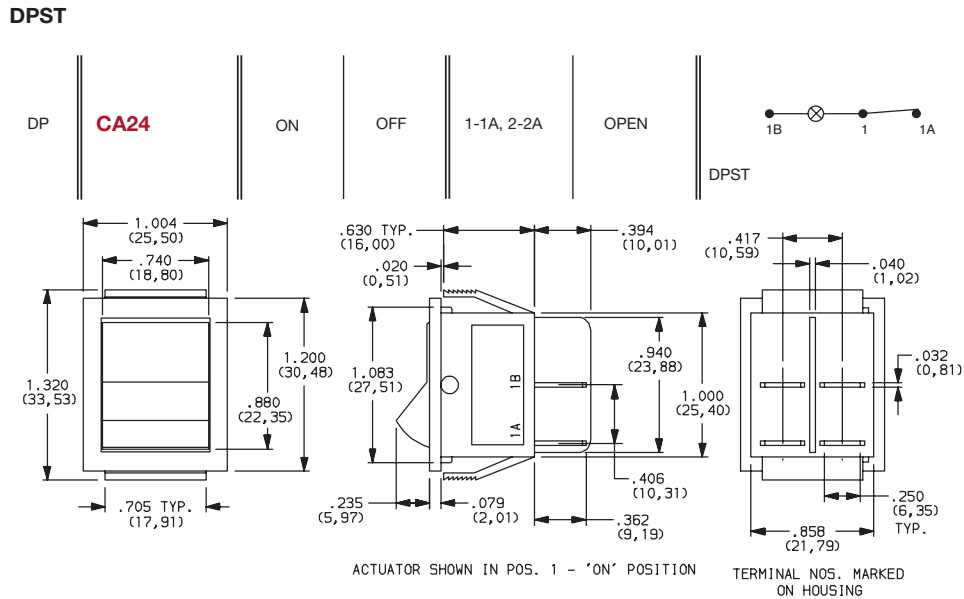

Part number shown: CA24J137207Q

See CONTACT MATERIAL section, page G-105, for complete contact ratings and agency approvals. Contacts make on side opposite actuator thrown.

All models with all options.

Rocker



G

C&K



Third Angle Projection
Dimensions are shown: Inches (mm)
Specifications and dimensions subject to change

CA Series Illuminated Power Rocker Switches

ACTUATOR



J1 ROCKER

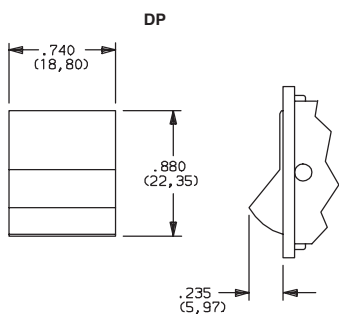
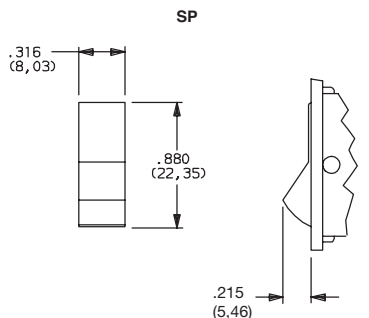

J7 CURVED ROCKER

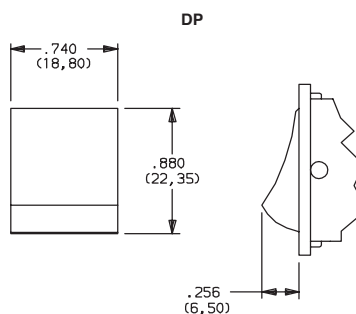
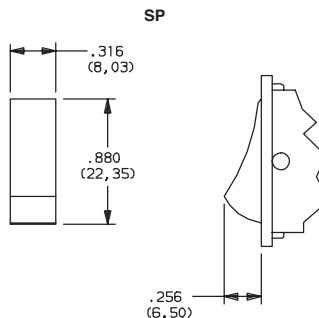

ACTUATOR COLOR



OPTION CODE	ACTUATOR COLOR
3	RED TRANSLUCENT
5	YELLOW
6	GREEN

NOTE: Special colors available, consult Customer Service Center.

NEON LAMP VOLTAGE



- 7 125 V NEON
- 8 250 V NEON

HOUSING COLOR



OPTION CODE	HOUSING COLOR
2	BLACK
1	WHITE

NOTE: Housing frame finish: matte. Special colors available, consult Customer Service Center.



Dimensions are shown: Inches (mm)
Specifications and dimensions subject to change



CA Series Illuminated Power Rocker Switches

TERMINATIONS

07 QUICK CONNECT

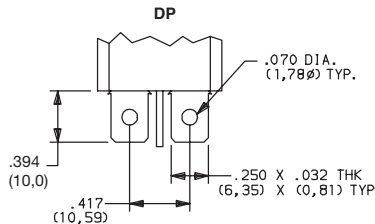
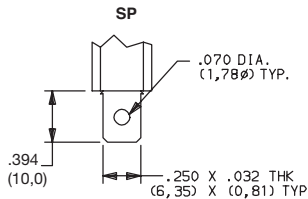

PANEL MOUNTING

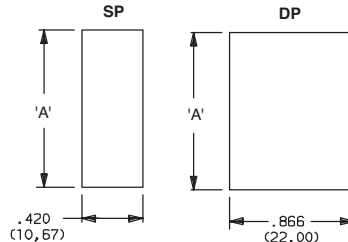

PANEL THICKNESS	DIM 'A'
.059-.078 (1,50) (2,00)	1.102 (28,00)
.078-.118 (2,00) (3,00)	1.110 (28,20)
.118-.177 (3,00) (4,50)	1.126 (28,60)

ACTUATOR MARKINGS

NONE NO MARKING



D ON-OFF

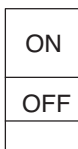

H O I

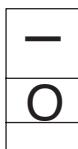

P O -

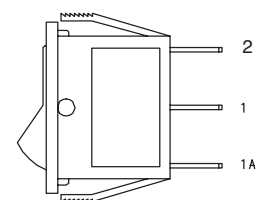

NOTE: Orientation of actuator markings and terminals

Marking color white, standard for all actuator colors except yellow. Marking color black, standard for yellow actuators. Consult Customer Service Center for other available markings and colors.

CONTACT MATERIAL

OPTION CODE	CONTACT AND TERMINAL MATERIAL	RATINGS	
Q	SILVER ¹	POWER	10 AMPS @ 250 VAC 15 AMPS @ 125 VAC 1/4 HP 125/250 VAC

* Note: See Technical Data section of this catalog for RoHS compliant and compatible definitions and specifications.

¹ CONTACTS: Coin silver, silver plated.
TERMINALS: Copper, silver plated.

All models with all options.

