

1. OpenCM9.04 Hardware

① Illustration of OpenCM9.04

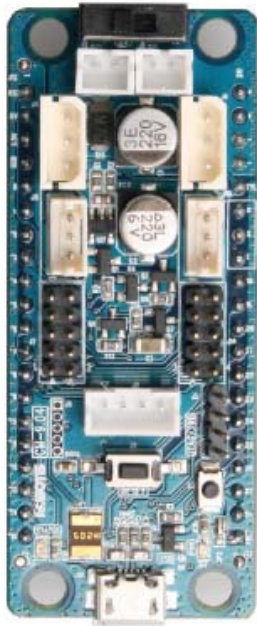

[TOP]

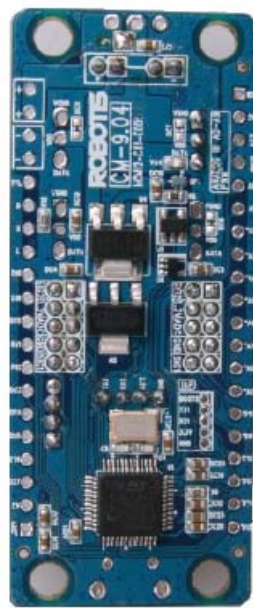

[BOTTOM]

② Parts label

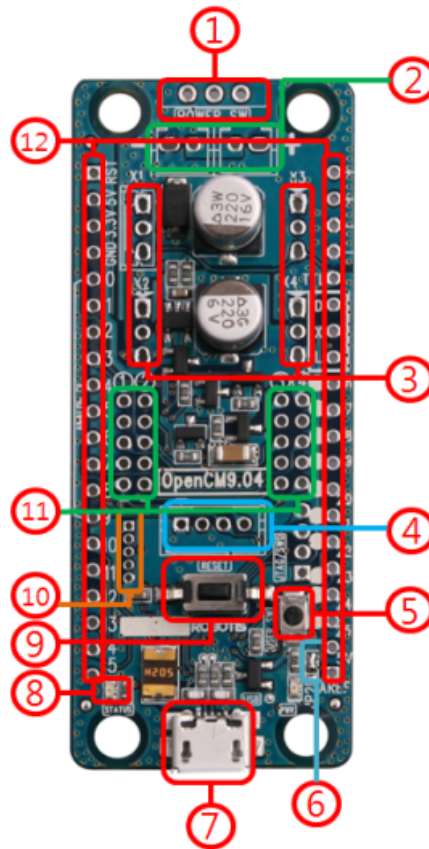

1. Power Switch: battery connection (power input).
2. Battery socket: sockets to connect Li-Ion Battery(ies). *[Note: each battery provides 3.7V; batteries in both pins provide 7.4V]*
3. DYNAMIXEL TTL BUS: ports for TTL-based Dynamixels. Connected dynamixels can be daisy-chained.
4. USART PIN: connect 4-pin devices such as the BT-110, BT-210, ZIG-110, LN-101 for UART communications (note: the LN-101 firmware only allows communications with the PC).
5. User Switch: user-programmable switch; OpenCM9.04 recovery-mode
6. Analog Reference Selection Jumper : change to 5V for analog signals.

7. Micro-B USB: Connect the OpenCM9.04 for communications, downloads, and 5V input power supply. Any type-B micro USB cable for Android phone is useful.
8. Status LED: Test LED for OpenCM9.04's programming. The LED blinks with a high/low signal to pin D16.
9. Reset switch: resets the CPU.
10. JTAG/SWD 4 PIN: Via JTAG/SWD terminal implement other programs such as IAR, Keil. The OpenCM9.04 has a total of 128Kbytes of memory, downloads and stores the bootloader's binary starting at 0x08000000. (Bootloader: 0x08000000 to 0x08002FFF. User programming space: 0x08003000 to 0x08020000).
11. External Sensor PIN: pins for Robotis' sensors.
12. 2.54 mm GPIO Header: Interface external devices to the OpenCM9.04's STM32F103CB CPU.

③ Product package

A Type Board Only

package		quantity
controller	OpenCM9.04	1
manual	User Guide	1

B type

package		quantity
controller	OpenCM9.04	1
PIN Header	1x20 Pin Header	2
BOX Header	1x20 BOX Header	2
USB cable	Micro B Cable	1
manual	User Guide	1

④ Product specifications

	OpenCM9.04
CPU	STM32F103CB (ARM Cortex-M3)
Op Voltage	5V~16V(USB 5V, DXL 12V, XL-Series 7.4V)
I/O	GPIO 26
Timer	8 (16bit)
Analog In(ADC)	10 (12bit)
Flash	128 Kbytes
SRAM	20 Kbytes
Clock	72Mhz(9 X 8 Mhz)
USB	1 (2.0 FullSpeed) Micro B type
CAN	1
USART	3
SPI	2
I2C(TWI)	2
Debug	JTAG & SWD
External Sensor	4
3 Pin TTL	4(XL combo 3 PIN)
SW Tool	ROBOTIS OpenCM
SIZE	27mm X 66.5 mm

⑤ Power

A. Connect to USB power

For programming simply connect the OpenCM9.04 via USB. The LED blinks I/O control under 5V becomes available.

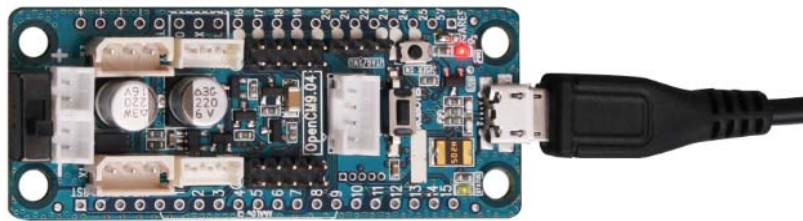

B. Connect to battery power

To control Dynamixel(s) connect the proper battery product. Afterwards the board runs the pre-downloaded mode.

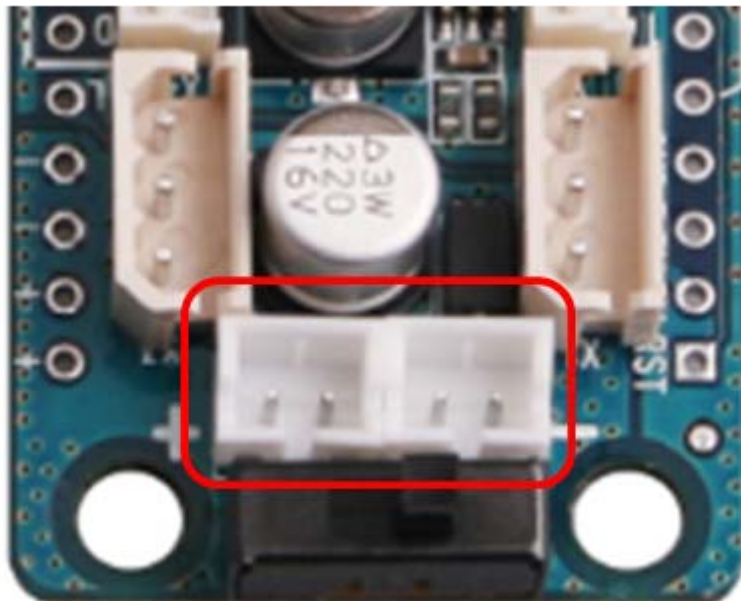

⑥ How-to-operate

- A. The OpenCM9.04 executes the user code (0x08003000) when powered under battery or USB.
- B. Connect to the PC via USB, write the program in the integrated development environment (IDE), compile and download the program.

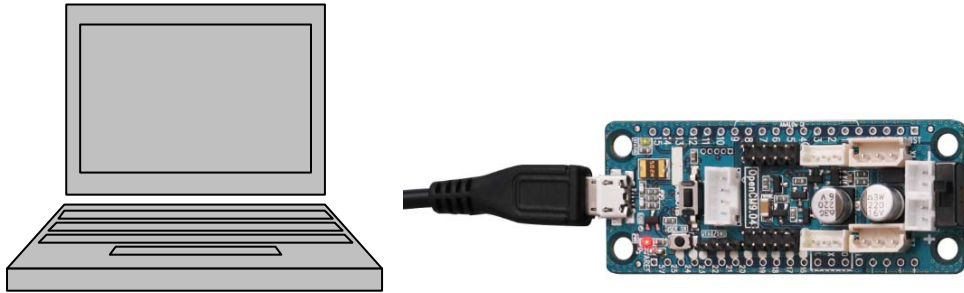

<connect the OpenCM9.04 to PC>

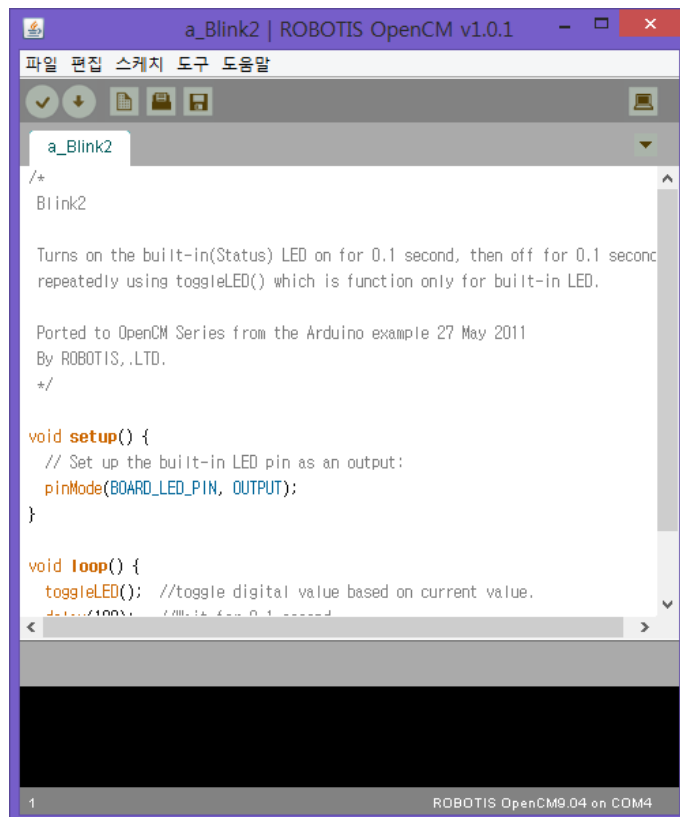
A screenshot of the ROBOTIS OpenCM IDE. The window title is 'a_Blink2 | ROBOTIS OpenCM v1.0.1'. The menu bar includes '파일', '편집', '스케치', '도구', and '도움말'. The toolbar has icons for file operations. The main editor shows the following code:

```
/*
Blink2

Turns on the built-in(Status) LED on for 0.1 second, then off for 0.1 second
repeatedly using toggleLED() which is function only for built-in LED.

Ported to OpenCM Series from the Arduino example 27 May 2011
By ROBOTIS,.LTD.
*/

void setup() {
  // Set up the built-in LED pin as an output:
  pinMode(BOARD_LED_PIN, OUTPUT);
}

void loop() {
  toggleLED(); //toggle digital value based on current value.
  delay(100); //wait for 0.1 second
```

The status bar at the bottom indicates '1' and 'ROBOTIS OpenCM9.04 on COM4'.

<OpenCM9.04 IDE ROBOTIS OpenCM>

⑦ Pin information

A. Power and switch

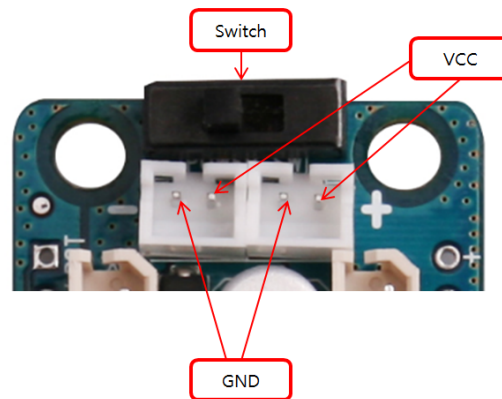

For switch use de-solder JP1

B. Refer to the OpenCM9.04's schematic for GPIO header pins to interface to the STM32F103CB CPU

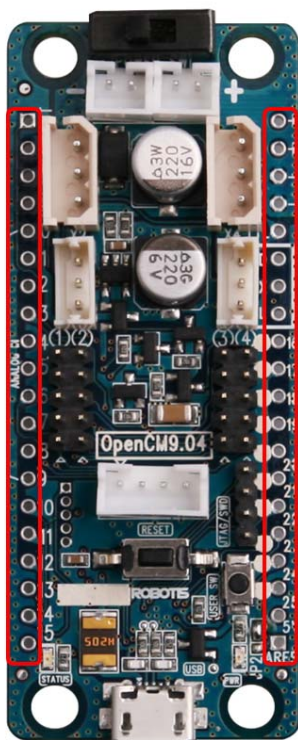

[OpenCM9.04 GPIO]

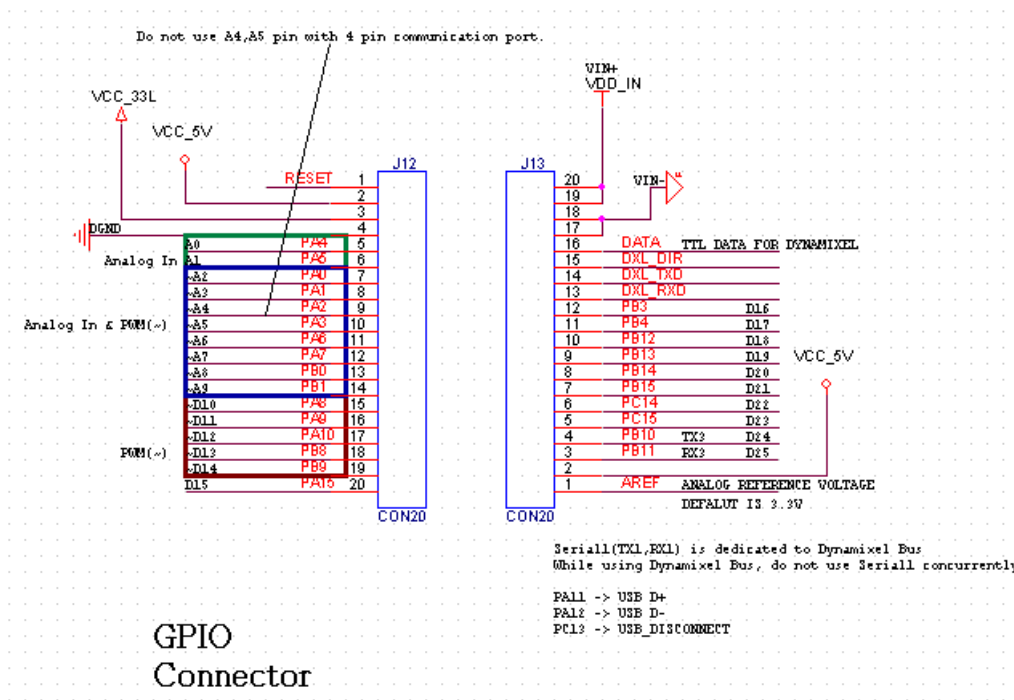

[OpenCM9.04 GPIO schematic]

For reference VDD is 12V; Dynamixel-related portions (pins PB5, PB6,

PB7) have been wired separately so they are not available for use

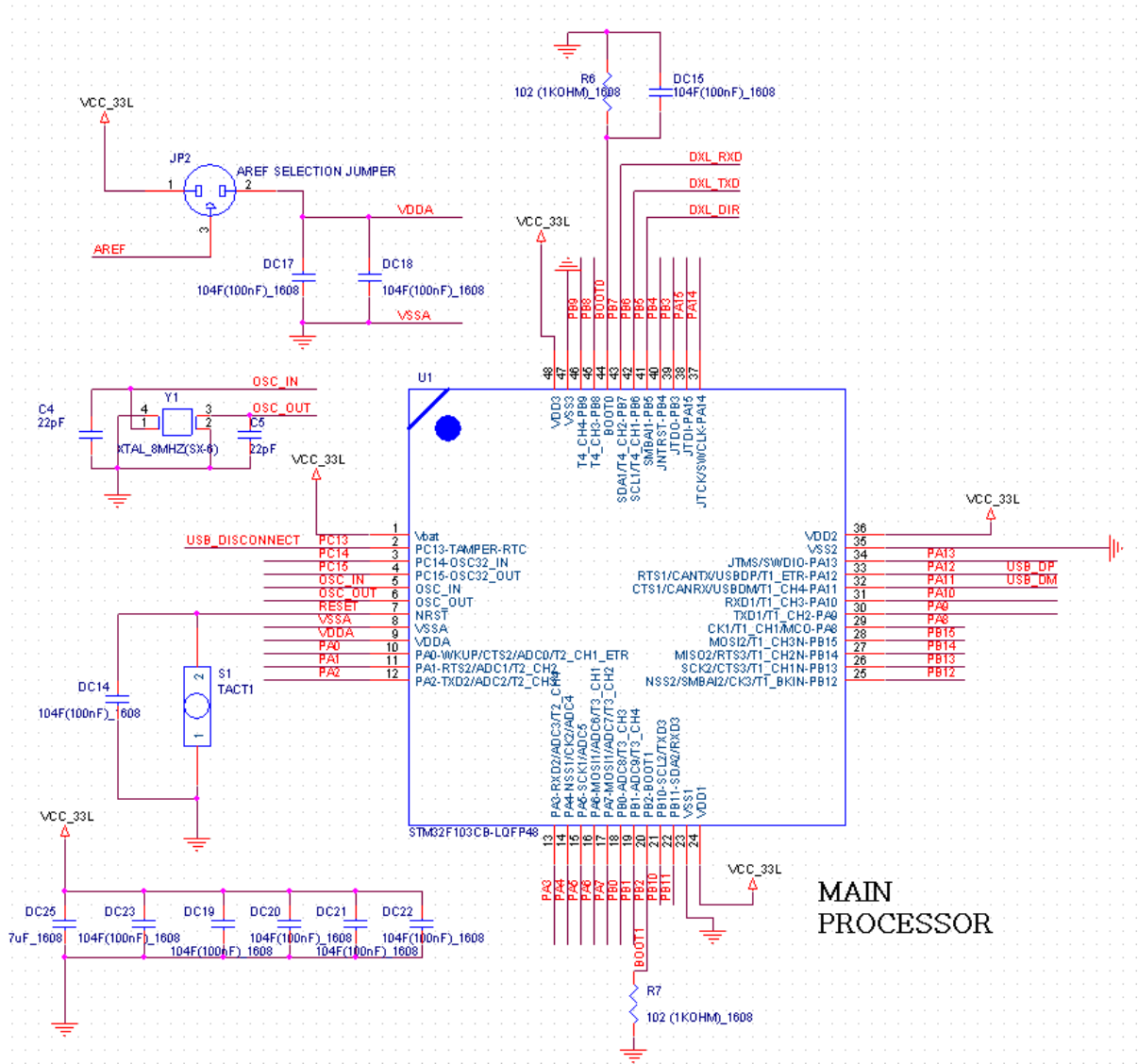

< STM32F103CB(LQFP48 Package) CPU connection schematic >

C. DYNAMIXEL TTL BUS

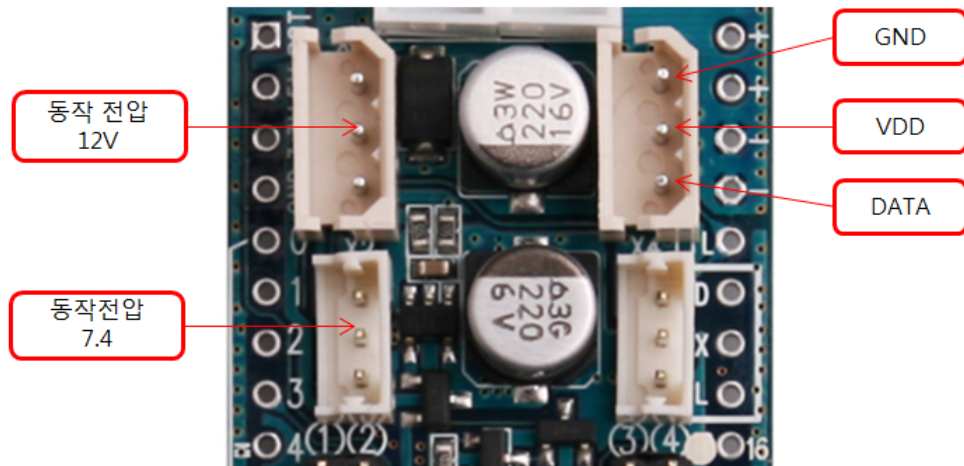

D. 4-pin communication devices

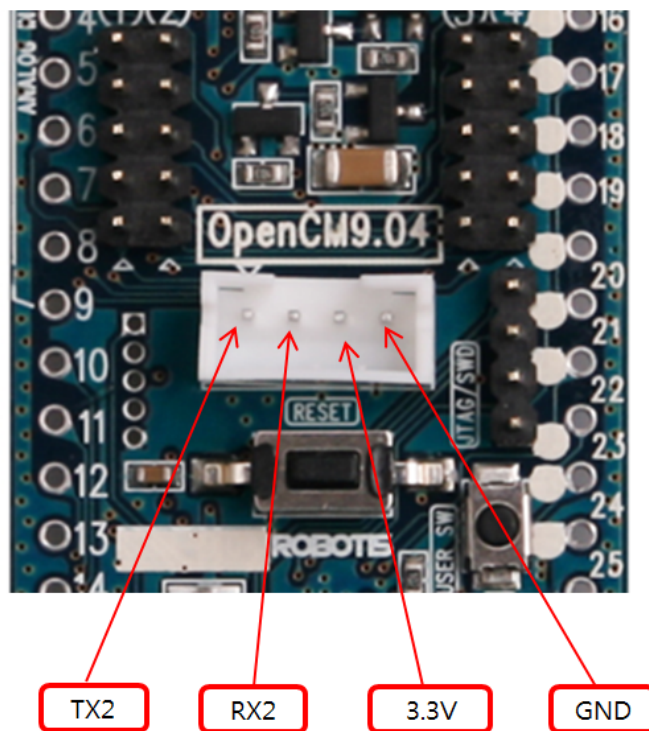

The same labels shown on the reverse side.



⑧ Schematic and PCB Gerber file (Schematic & Gerber Design)

The OpenCM9.04 resources (both hardware and software) are 100% open. Resources can be obtained via gitHub with the link below.

<https://github.com/robotis-pandora/ROBOTIS-OpenCM.git>

⑨ Emergency recovery mode

- A. Whether the OpenCM9.04 USB drivers are not initialized nor device detected press the switch and connection will reestablish.

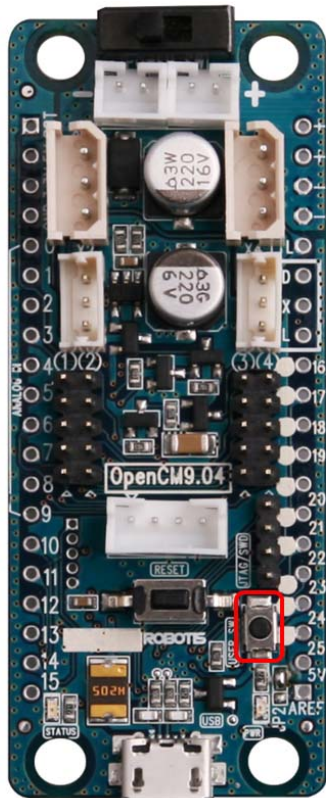

- B. When connected via USB check the STATUS LED.



- C. Go to File -> examples -> Digital -> Blink example; download it and

press the button (any other example OK).

