



Is Now Part of



**ON Semiconductor®**

To learn more about ON Semiconductor, please visit our website at  
[www.onsemi.com](http://www.onsemi.com)

Please note: As part of the Fairchild Semiconductor integration, some of the Fairchild orderable part numbers will need to change in order to meet ON Semiconductor's system requirements. Since the ON Semiconductor product management systems do not have the ability to manage part nomenclature that utilizes an underscore (\_), the underscore (\_) in the Fairchild part numbers will be changed to a dash (-). This document may contain device numbers with an underscore (\_). Please check the ON Semiconductor website to verify the updated device numbers. The most current and up-to-date ordering information can be found at [www.onsemi.com](http://www.onsemi.com). Please email any questions regarding the system integration to [Fairchild\\_questions@onsemi.com](mailto:Fairchild_questions@onsemi.com).

ON Semiconductor and the ON Semiconductor logo are trademarks of Semiconductor Components Industries, LLC dba ON Semiconductor or its subsidiaries in the United States and/or other countries. ON Semiconductor owns the rights to a number of patents, trademarks, copyrights, trade secrets, and other intellectual property. A listing of ON Semiconductor's product/patent coverage may be accessed at [www.onsemi.com/site/pdf/Patent-Marking.pdf](http://www.onsemi.com/site/pdf/Patent-Marking.pdf). ON Semiconductor reserves the right to make changes without further notice to any products herein. ON Semiconductor makes no warranty, representation or guarantee regarding the suitability of its products for any particular purpose, nor does ON Semiconductor assume any liability arising out of the application or use of any product or circuit, and specifically disclaims any and all liability, including without limitation special, consequential or incidental damages. Buyer is responsible for its products and applications using ON Semiconductor products, including compliance with all laws, regulations and safety requirements or standards, regardless of any support or applications information provided by ON Semiconductor. "Typical" parameters which may be provided in ON Semiconductor data sheets and/or specifications can and do vary in different applications and actual performance may vary over time. All operating parameters, including "Typicals" must be validated for each customer application by customer's technical experts. ON Semiconductor does not convey any license under its patent rights nor the rights of others. ON Semiconductor products are not designed, intended, or authorized for use as a critical component in life support systems or any FDA Class 3 medical devices or medical devices with a same or similar classification in a foreign jurisdiction or any devices intended for implantation in the human body. Should Buyer purchase or use ON Semiconductor products for any such unintended or unauthorized application, Buyer shall indemnify and hold ON Semiconductor and its officers, employees, subsidiaries, affiliates, and distributors harmless against all claims, costs, damages, and expenses, and reasonable attorney fees arising out of, directly or indirectly, any claim of personal injury or death associated with such unintended or unauthorized use, even if such claim alleges that ON Semiconductor was negligent regarding the design or manufacture of the part. ON Semiconductor is an Equal Opportunity/Affirmative Action Employer. This literature is subject to all applicable copyright laws and is not for resale in any manner.



April 2016

# FODM100x Series Single Channel, DC Sensing Input, Phototransistor Optocoupler In Stretched Body SOP 4-Pin

## Features

- $\geq 8$  mm Creepage and Clearance Distance, and  $\geq 0.4$  mm Insulation Distance to Achieve Reliable and High Voltage Insulation
- Safety and Regulatory Approvals
- UL1577, 5,000 VAC<sub>RMS</sub> for 1 min.
- DIN\_EN/IEC60747-5-5, 890 V<sub>Peak</sub> Working Voltage (pending approval)
- High Breakdown Collector to Emitter Voltage, BV<sub>CEO</sub> = 70 V minimum
- Extended Industrial Temperature Range, -40 to 110°C
- Current Transfer Ratio at I<sub>F</sub> = 5 mA, V<sub>CE</sub> = 5 V, T<sub>A</sub> = 25°C
- FODM1007: 80 to 160%
- FODM1008: 130 to 260%
- FODM1009: 200 to 400%

## Related Resources

- [www.fairchildsemi.com/products/optoelectronics/](http://www.fairchildsemi.com/products/optoelectronics/)
- [www.fairchildsemi.com/datasheets/HM/HMHA2801.pdf](http://www.fairchildsemi.com/datasheets/HM/HMHA2801.pdf)

## Description

The FODM100x Series, single channel, DC sensing input, optocoupler consists of one gallium arsenide (GaAs) infrared light emitting diode optically coupled to one phototransistor, in a stretched body SOP 4-pin package. The input-output isolation voltage, V<sub>ISO</sub>, is rated at 5,000 VAC<sub>RMS</sub>.

## Applications

- Primarily suited for DC-DC Converters
- For ground loop isolation, signal to noise isolation
- Communications – adapters, chargers
- Consumer – appliances, set top boxes
- Industrial – power supplies, motor control, programmable logic control

## Schematic

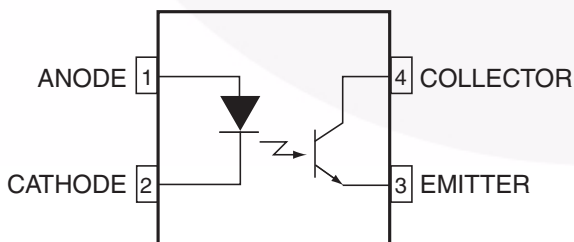


Figure 1. Schematic

## Package

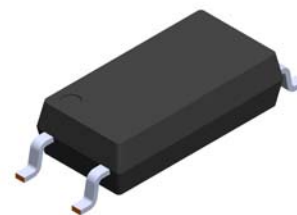


Figure 2. Package Outline

FODM100x Series Single Channel, DC Sensing Input, Phototransistor Optocoupler In Stretched Body SOP 4-Pin

## Safety and Insulation Ratings

As per DIN EN/IEC 60747-5-5 (pending approval), this optocoupler is suitable for “safe electrical insulation” only within the safety limit data. Compliance with the safety ratings shall be ensured by means of protective circuits.

Parameter		Characteristics
Installation Classifications per DIN VDE 0110/1.89 Table 1, For Rated Mains Voltage	< 150 V <sub>RMS</sub>	I–IV
	< 300 V <sub>RMS</sub>	I–III
Climatic Classification		40/110/21
Pollution Degree (DIN VDE 0110/1.89)		2
Comparative Tracking Index		175

Symbol	Parameter	Value	Unit
V <sub>PR</sub>	Input-to-Output Test Voltage, Method A, V <sub>IORM</sub> × 1.6 = V <sub>PR</sub> , Type and Sample Test with t <sub>m</sub> = 10 s, Partial Discharge < 5 pC	1,426	V <sub>peak</sub>
	Input-to-Output Test Voltage, Method B, V <sub>IORM</sub> × 1.875 = V <sub>PR</sub> , 100% Production Test with t <sub>m</sub> = 1 s, Partial Discharge < 5 pC	1,671	V <sub>peak</sub>
V <sub>IORM</sub>	Maximum Working Insulation Voltage	890	V <sub>peak</sub>
V <sub>IOTM</sub>	Highest Allowable Over-Voltage	6,000	V <sub>peak</sub>
	External Creepage	≥ 8.0	mm
	External Clearance	≥ 8.0	mm
DTI	Distance Through Insulation (Insulation Thickness)	≥ 0.4	mm
T <sub>S</sub>	Case Temperature <sup>(1)</sup>	150	°C
I <sub>S,INPUT</sub>	Input Current <sup>(1)</sup>	200	mA
P <sub>S,OUTPUT</sub>	Output Power <sup>(1)</sup>	300	mW
R <sub>IO</sub>	Insulation Resistance at T <sub>S</sub> , V <sub>IO</sub> = 500 V <sup>(1)</sup>	> 10 <sup>9</sup>	Ω

**Note:**

1. Safety limit values – maximum values allowed in the event of a failure

## Absolute Maximum Ratings

Stresses exceeding the absolute maximum ratings may damage the device. The device may not function or be operable above the recommended operating conditions and stressing the parts to these levels is not recommended. In addition, extended exposure to stresses above the recommended operating conditions may affect device reliability. The absolute maximum ratings are stress ratings only.  $T_A = 25^\circ\text{C}$  unless otherwise specified.

Symbol	Parameter	Value	Unit
<b>TOTAL PACKAGE</b>			
$T_{STG}$	Storage Temperature	-55 to +150	$^\circ\text{C}$
$T_{OPR}$	Operating Temperature	-40 to +110	$^\circ\text{C}$
$T_J$	Junction Temperature	-40 to +125	$^\circ\text{C}$
<b>EMITTER</b>			
$I_F$ (avg)	Continuous Forward Current	50	mA
$I_F$ (pk)	Peak Forward Current (1 $\mu\text{s}$ pulse, 300 pps)	1	A
$V_R$	Reverse Input Voltage	6	V
$PD_{LED}$	LED Power Dissipation @ $T_A = 25^\circ\text{C}$ <sup>(2)</sup>	100	mW
	Derate Above $25^\circ\text{C}$	0.9	$\text{mW}/^\circ\text{C}$
<b>DETECTOR</b>			
$I_C$	Continuous Collector Current	50	mA
$V_{CEO}$	Collector-Emitter Voltage	70	V
$V_{ECO}$	Emitter-Collector Voltage	7	V
$PD_C$	Detector Power Dissipation @ $T_A = 25^\circ\text{C}$ <sup>(2)</sup>	150	mW
	Derate Above $25^\circ\text{C}$	1.47	$\text{mW}/^\circ\text{C}$

### Note:

- Functional operation under these conditions is not implied. Permanent damage may occur if the device is subjected to conditions outside these ratings.

## Electrical Characteristics

$T_A = 25^\circ\text{C}$  unless otherwise specified.

### Individual Component Characteristics

Symbol	Parameter	Device	Test Conditions	Min.	Typ.	Max.	Unit
<b>EMITTER</b>							
$V_F$	Forward Voltage	All	$I_F = 50\text{ mA}$		1.4	1.6	V
$I_R$	Reverse Current	All	$V_R = 4\text{ V}$			10	$\mu\text{A}$
<b>DETECTOR</b>							
$BV_{CEO}$	Breakdown Voltage Collector to Emitter	All	$I_C = 1\text{ mA}, I_F = 0$	70			V
$BV_{ECO}$	Emitter to Collector	All	$I_E = 0.1\text{ mA}, I_F = 0$	7			V
$I_{CEO}$	Collector Dark Current	All	$V_{CE} = 70\text{ V}, I_F = 0$			100	nA
$C_{CE}$	Capacitance	All	$V_{CE} = 0\text{ V}, f = 1\text{ MHz}$		5		pF

### DC Transfer Characteristics

Symbol	Parameter	Device	Test Conditions	Min.	Typ.	Max.	Unit
CTR	DC Current Transfer Ratio	FODM1007	$I_F = 5\text{ mA}, V_{CE} = 5\text{ V}$	80		160	%
		FODM1008		130		260	
		FODM1009		200		400	
$V_{CE(SAT)}$	Saturation Voltage	All	$I_F = 10\text{ mA}, I_C = 1\text{ mA}$			0.3	V

### AC Transfer Characteristics

Symbol	Parameter	Device	Test Conditions	Min.	Typ.	Max.	Unit
$t_r$	Rise Time (Non-Saturated)	All	$I_C = 2\text{ mA}, V_{CE} = 5\text{ V}, R_L = 100\ \Omega$		5.7	18.0	$\mu\text{s}$
$t_f$	Fall Time (Non-Saturated)	All	$I_C = 2\text{ mA}, V_{CE} = 5\text{ V}, R_L = 100\ \Omega$		8.5	18.0	

### Isolation Characteristics

Symbol	Parameter	Device	Test Conditions	Min.	Typ.	Max.	Unit
$V_{ISO}$	Steady State Isolation Voltage	All	$T_A = 25^\circ\text{C}, \text{R.H.} < 50\%, t = 1.0\text{ minute}, I_{I-O} \leq 20\ \mu\text{A}$	5,000			$V_{AC_{RMS}}$

### Typical Performance Characteristics

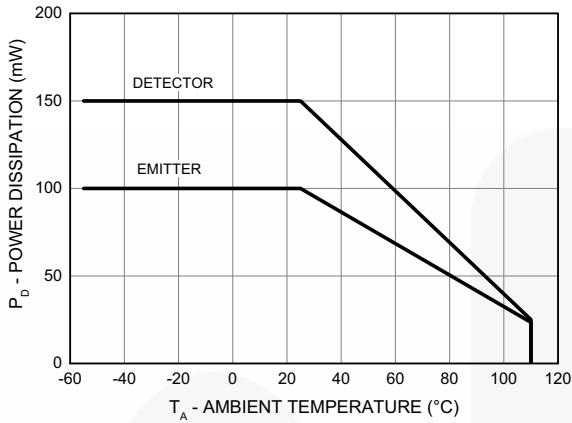


Figure 3. Power Dissipation vs. Ambient Temperature

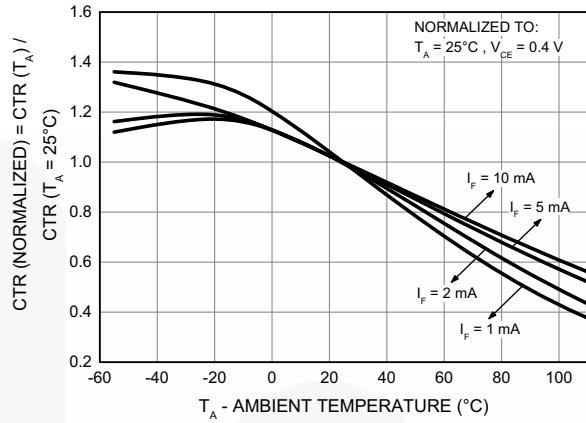


Figure 4. Saturated Normalized Current Transfer Ratio vs. Ambient Temperature

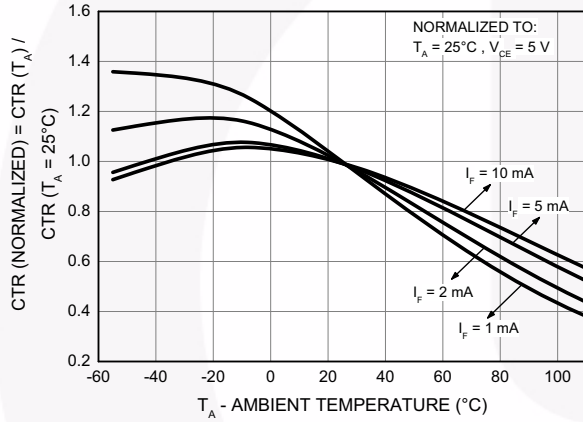


Figure 5. Non-Saturated Normalized Current Transfer Ratio vs. Ambient Temperature

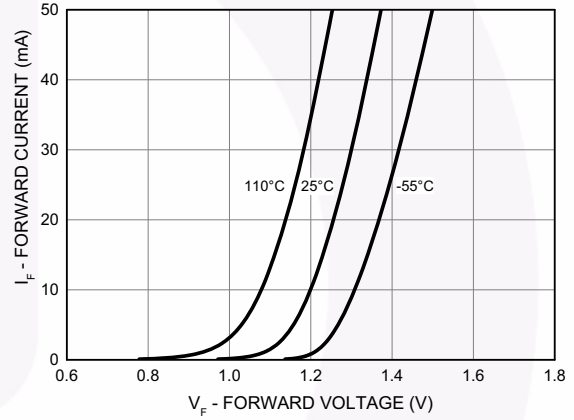


Figure 6. Forward Current vs. Forward Voltage

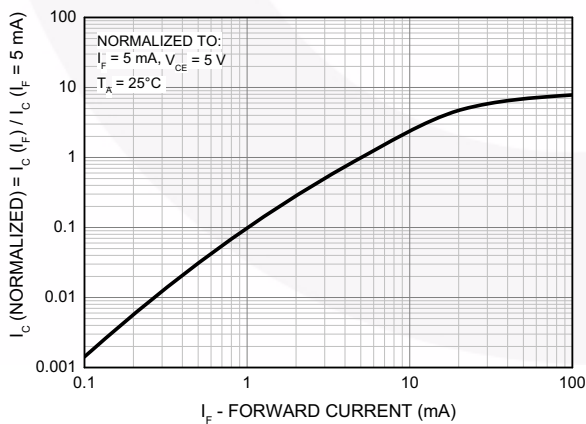


Figure 7. Normalized Current Collector vs. Forward Current

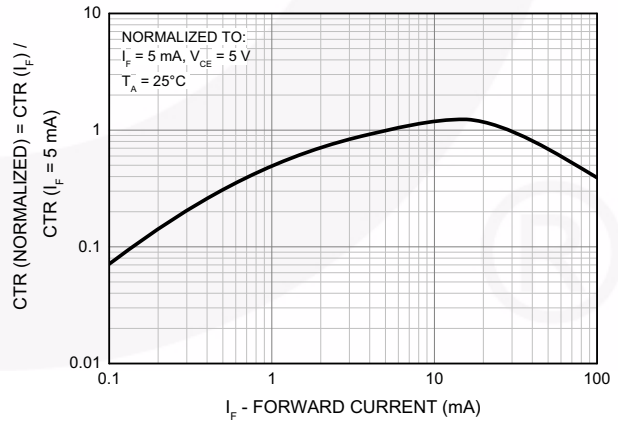
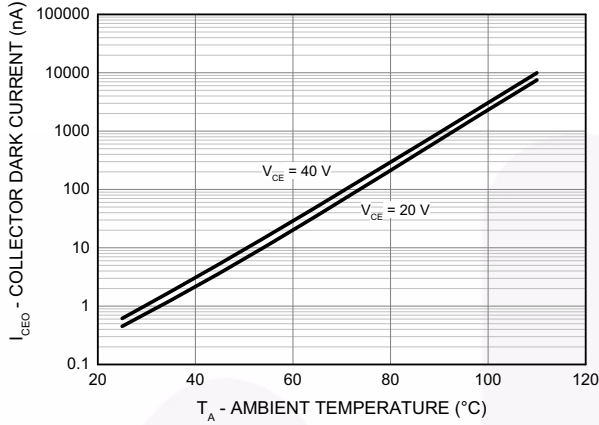
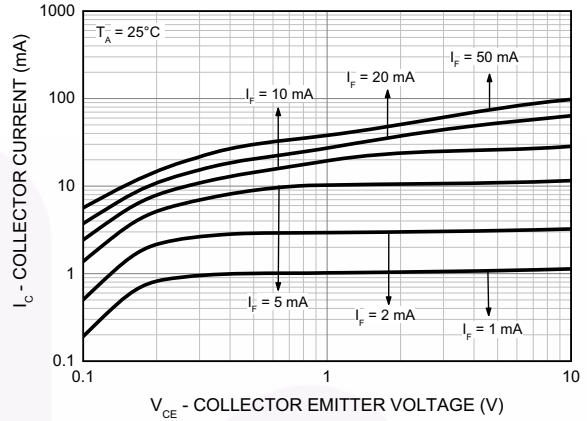


Figure 8. Normalized Current Transfer Ratio vs. Forward Current

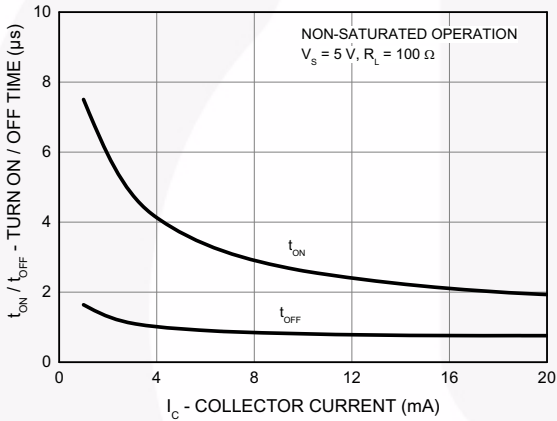
**Typical Performance Characteristics (Continued)**



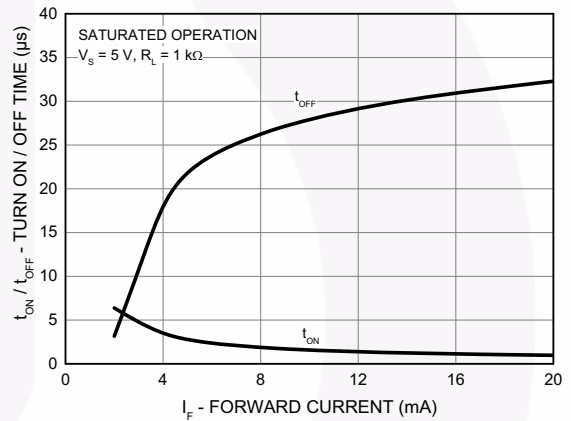
**Figure 9. Collector Dark Current vs. Ambient Temperature**



**Figure 10. Collector Current vs. Collector Emitter Voltage**

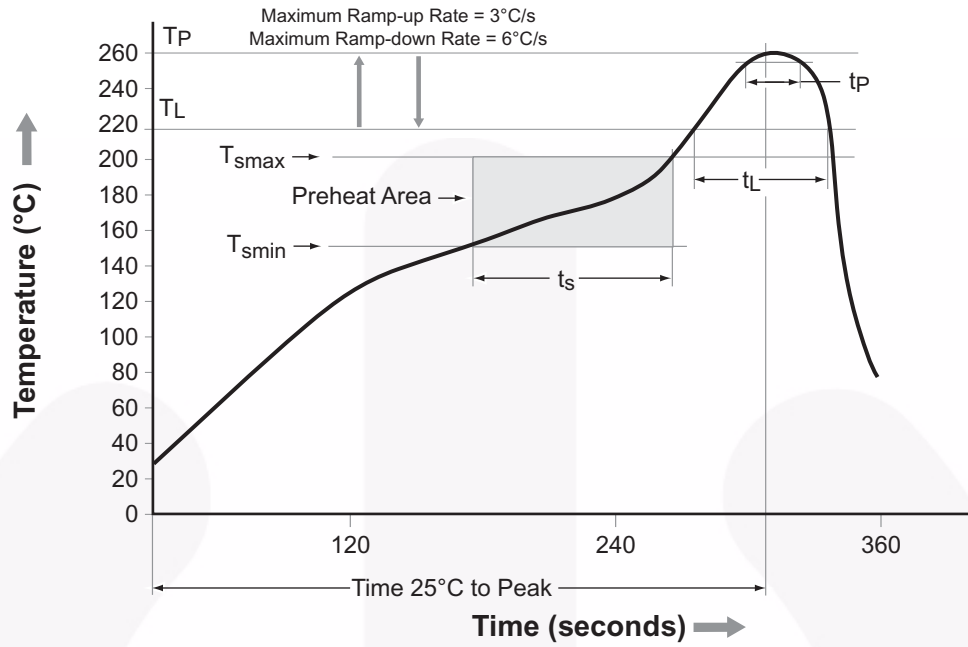


**Figure 11. Turn On/ Turn Off Time vs. Collector Current**



**Figure 12. Turn On/ Turn Off Time vs. Forward Current**

## Reflow Profile



Profile Feature	Pb-Free Assembly Profile
Temperature Minimum ( $T_{smin}$ )	150°C
Temperature Maximum ( $T_{smax}$ )	200°C
Time ( $t_s$ ) from ( $T_{smin}$ to $T_{smax}$ )	60 s to 120 s
Ramp-up Rate ( $t_L$ to $t_P$ )	3°C/second maximum
Liquidous Temperature ( $T_L$ )	217°C
Time ( $t_L$ ) Maintained Above ( $T_L$ )	60 s to 150 s
Peak Body Package Temperature	260°C +0°C / -5°C
Time ( $t_p$ ) within 5°C of 260°C	30 s
Ramp-Down Rate ( $T_P$ to $T_L$ )	6°C/s maximum
Time 25°C to Peak Temperature	8 minutes maximum

Figure 13. Reflow Profile



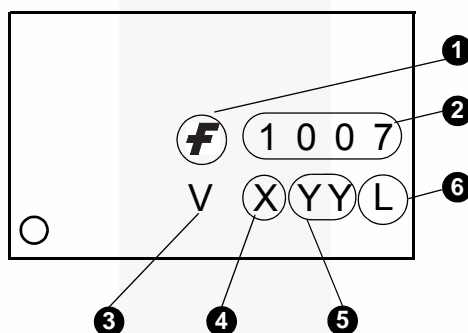
## Ordering Information

Part Number	Package	Packing Method
FODM1007	Stretched Body SOP 4-Pin	Tube (100 units per tube)
FODM1007R2	Stretched Body SOP 4-Pin	Tape and Reel (3,000 units per reel)
FODM1007V	Stretched Body SOP 4-Pin, DIN EN/IEC60747-5-5 Option (pending approval)	Tube (100 units per tube)
FODM1007R2V	Stretched Body SOP 4-Pin, DIN EN/IEC60747-5-5 Option (pending approval)	Tape and Reel (3,000 units per reel)

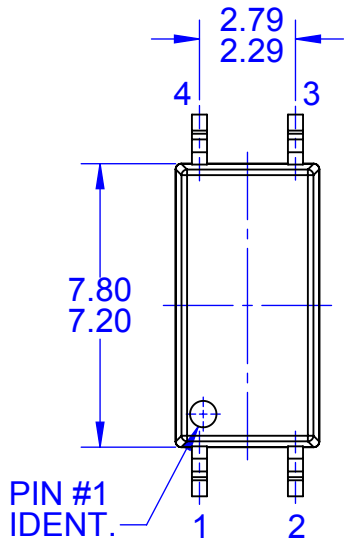
**Note:**

2. The product orderable part number system listed in this table also applies to the FODM1008, and FODM1009 products.

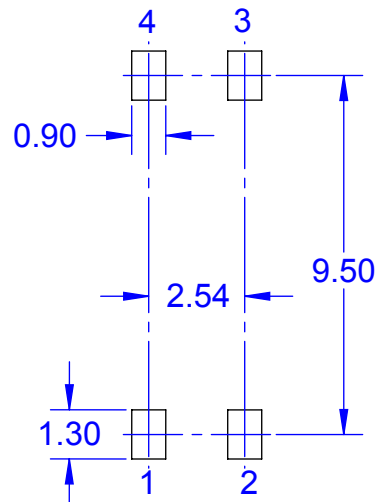
## Marking Information



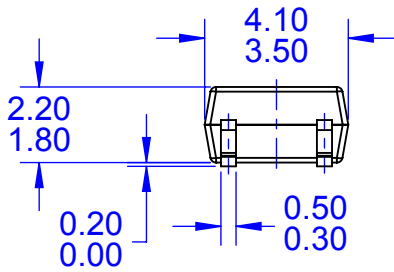
Definitions	
1	Fairchild Logo
2	Device Number, e.g. 1007
3	DIN EN/IEC60747-5-5 Option (only appears on component ordered with this option) (pending for approval)
4	Last Digit Year Code, e.g. '6'
5	Two Digit Work Week Ranging from '01' to '53'
6	Assembly Package Code



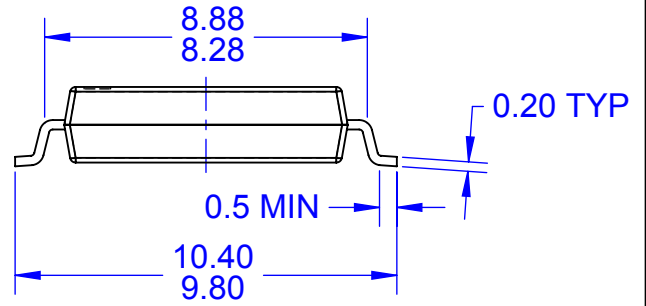
TOP VIEW



LAND PATTERN RECOMMENDATION



FRONT VIEW



SIDE VIEW

NOTES:

- A. NO INDUSTRY STANDARD APPLIES TO THIS PACKAGE
- B. ALL DIMENSIONS ARE IN MILLIMETERS
- C. DIMENSIONS DO NOT INCLUDE MOLD FLASH OR BURRS
- D. DRAWING FILENAME: MKT-LSOP04Arev1



ON Semiconductor and  are trademarks of Semiconductor Components Industries, LLC dba ON Semiconductor or its subsidiaries in the United States and/or other countries. ON Semiconductor owns the rights to a number of patents, trademarks, copyrights, trade secrets, and other intellectual property. A listing of ON Semiconductor's product/patent coverage may be accessed at [www.onsemi.com/site/pdf/Patent-Marking.pdf](http://www.onsemi.com/site/pdf/Patent-Marking.pdf). ON Semiconductor reserves the right to make changes without further notice to any products herein. ON Semiconductor makes no warranty, representation or guarantee regarding the suitability of its products for any particular purpose, nor does ON Semiconductor assume any liability arising out of the application or use of any product or circuit, and specifically disclaims any and all liability, including without limitation special, consequential or incidental damages. Buyer is responsible for its products and applications using ON Semiconductor products, including compliance with all laws, regulations and safety requirements or standards, regardless of any support or applications information provided by ON Semiconductor. "Typical" parameters which may be provided in ON Semiconductor data sheets and/or specifications can and do vary in different applications and actual performance may vary over time. All operating parameters, including "Typicals" must be validated for each customer application by customer's technical experts. ON Semiconductor does not convey any license under its patent rights nor the rights of others. ON Semiconductor products are not designed, intended, or authorized for use as a critical component in life support systems or any FDA Class 3 medical devices or medical devices with a same or similar classification in a foreign jurisdiction or any devices intended for implantation in the human body. Should Buyer purchase or use ON Semiconductor products for any such unintended or unauthorized application, Buyer shall indemnify and hold ON Semiconductor and its officers, employees, subsidiaries, affiliates, and distributors harmless against all claims, costs, damages, and expenses, and reasonable attorney fees arising out of, directly or indirectly, any claim of personal injury or death associated with such unintended or unauthorized use, even if such claim alleges that ON Semiconductor was negligent regarding the design or manufacture of the part. ON Semiconductor is an Equal Opportunity/Affirmative Action Employer. This literature is subject to all applicable copyright laws and is not for resale in any manner.

## PUBLICATION ORDERING INFORMATION

### LITERATURE FULFILLMENT:

Literature Distribution Center for ON Semiconductor  
19521 E. 32nd Pkwy, Aurora, Colorado 80011 USA  
**Phone:** 303-675-2175 or 800-344-3860 Toll Free USA/Canada  
**Fax:** 303-675-2176 or 800-344-3867 Toll Free USA/Canada  
**Email:** [orderlit@onsemi.com](mailto:orderlit@onsemi.com)

**N. American Technical Support:** 800-282-9855 Toll Free  
USA/Canada  
**Europe, Middle East and Africa Technical Support:**  
Phone: 421 33 790 2910  
**Japan Customer Focus Center**  
Phone: 81-3-5817-1050

**ON Semiconductor Website:** [www.onsemi.com](http://www.onsemi.com)  
**Order Literature:** <http://www.onsemi.com/orderlit>  
For additional information, please contact your local  
Sales Representative

# Mouser Electronics

Authorized Distributor

Click to View Pricing, Inventory, Delivery & Lifecycle Information:

[ON Semiconductor:](#)

[FODM1009R2](#) [FODM1009](#)