



Thyristor \ Diode Module

$V_{RRM} = 2 \times 1200 \text{ V}$

$I_{TAV} = 320 \text{ A}$

$V_T = 1.08 \text{ V}$

Phase leg

Part number

MCD310-12io1

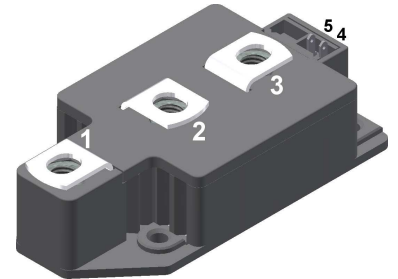

Backside: isolated



Features / Advantages:

- Thyristor for line frequency
- Planar passivated chip
- Long-term stability
- Direct Copper Bonded Al₂O₃-ceramic

Applications:

- Line rectifying 50/60 Hz
- Softstart AC motor control
- DC Motor control
- Power converter
- AC power control
- Lighting and temperature control

Package: Y2

- Isolation Voltage: 3600 V~
- Industry standard outline
- RoHS compliant
- Soldering pins for PCB mounting
- Base plate: DCB ceramic
- Reduced weight
- Advanced power cycling

Disclaimer Notice

Information furnished is believed to be accurate and reliable. However, users should independently evaluate the suitability of and test each product selected for their own applications. Littelfuse products are not designed for, and may not be used in, all applications. Read complete Disclaimer Notice at www.littelfuse.com/disclaimer-electronics.

Rectifier			Ratings			
Symbol	Definition	Conditions	min.	typ.	max.	Unit
$V_{RSM/DSM}$	max. non-repetitive reverse/forward blocking voltage	$T_{VJ} = 25^{\circ}\text{C}$			1300	V
$V_{RRM/DRM}$	max. repetitive reverse/forward blocking voltage	$T_{VJ} = 25^{\circ}\text{C}$			1200	V
I_{RD}	reverse current, drain current	$V_{R/D} = 1200\text{ V}$	$T_{VJ} = 25^{\circ}\text{C}$		1	mA
		$V_{R/D} = 1200\text{ V}$	$T_{VJ} = 140^{\circ}\text{C}$		40	mA
V_T	forward voltage drop	$I_T = 300\text{ A}$	$T_{VJ} = 25^{\circ}\text{C}$		1.14	V
		$I_T = 600\text{ A}$			1.32	V
		$I_T = 300\text{ A}$	$T_{VJ} = 125^{\circ}\text{C}$		1.08	V
		$I_T = 600\text{ A}$			1.30	V
I_{TAV}	average forward current	$T_C = 85^{\circ}\text{C}$	$T_{VJ} = 140^{\circ}\text{C}$		320	A
$I_{T(RMS)}$	RMS forward current	180° sine			500	A
V_{T0}	threshold voltage	} for power loss calculation only	$T_{VJ} = 140^{\circ}\text{C}$		0.80	V
r_T	slope resistance				0.82	mΩ
R_{thJC}	thermal resistance junction to case				0.11	K/W
R_{thCH}	thermal resistance case to heatsink			0.04		K/W
P_{tot}	total power dissipation		$T_C = 25^{\circ}\text{C}$		1030	W
I_{TSM}	max. forward surge current	$t = 10\text{ ms}; (50\text{ Hz}), \text{ sine}$	$T_{VJ} = 45^{\circ}\text{C}$		9.20	kA
		$t = 8,3\text{ ms}; (60\text{ Hz}), \text{ sine}$	$V_R = 0\text{ V}$		9.94	kA
		$t = 10\text{ ms}; (50\text{ Hz}), \text{ sine}$	$T_{VJ} = 140^{\circ}\text{C}$		7.82	kA
		$t = 8,3\text{ ms}; (60\text{ Hz}), \text{ sine}$	$V_R = 0\text{ V}$		8.45	kA
I^2t	value for fusing	$t = 10\text{ ms}; (50\text{ Hz}), \text{ sine}$	$T_{VJ} = 45^{\circ}\text{C}$		423.2	kA ² s
		$t = 8,3\text{ ms}; (60\text{ Hz}), \text{ sine}$	$V_R = 0\text{ V}$		410.6	kA ² s
		$t = 10\text{ ms}; (50\text{ Hz}), \text{ sine}$	$T_{VJ} = 140^{\circ}\text{C}$		305.8	kA ² s
		$t = 8,3\text{ ms}; (60\text{ Hz}), \text{ sine}$	$V_R = 0\text{ V}$		296.7	kA ² s
C_J	junction capacitance	$V_R = 400\text{ V}$ $f = 1\text{ MHz}$	$T_{VJ} = 25^{\circ}\text{C}$		438	pF
P_{GM}	max. gate power dissipation	$t_p = 30\text{ }\mu\text{s}$	$T_C = 140^{\circ}\text{C}$		120	W
		$t_p = 500\text{ }\mu\text{s}$			60	W
P_{GAV}	average gate power dissipation				20	W
$(di/dt)_{cr}$	critical rate of rise of current	$T_{VJ} = 140^{\circ}\text{C}; f = 50\text{ Hz}$ repetitive, $I_T = 960\text{ A}$			100	A/ μs
		$t_p = 200\text{ }\mu\text{s}; di_G/dt = 1\text{ A}/\mu\text{s};$ $I_G = 1\text{ A}; V = \frac{2}{3} V_{DRM}$ non-repet., $I_T = 320\text{ A}$			500	A/ μs
$(dv/dt)_{cr}$	critical rate of rise of voltage	$V = \frac{2}{3} V_{DRM}$	$T_{VJ} = 140^{\circ}\text{C}$		1000	V/ μs
		$R_{GK} = \infty$; method 1 (linear voltage rise)				
V_{GT}	gate trigger voltage	$V_D = 6\text{ V}$	$T_{VJ} = 25^{\circ}\text{C}$		2	V
			$T_{VJ} = -40^{\circ}\text{C}$		3	V
I_{GT}	gate trigger current	$V_D = 6\text{ V}$	$T_{VJ} = 25^{\circ}\text{C}$		150	mA
			$T_{VJ} = -40^{\circ}\text{C}$		200	mA
V_{GD}	gate non-trigger voltage	$V_D = \frac{2}{3} V_{DRM}$	$T_{VJ} = 140^{\circ}\text{C}$		0.25	V
I_{GD}	gate non-trigger current				10	mA
I_L	latching current	$t_p = 30\text{ }\mu\text{s}$	$T_{VJ} = 25^{\circ}\text{C}$		200	mA
		$I_G = 0.45\text{ A}; di_G/dt = 0.45\text{ A}/\mu\text{s}$				
I_H	holding current	$V_D = 6\text{ V}$ $R_{GK} = \infty$	$T_{VJ} = 25^{\circ}\text{C}$		150	mA
t_{gd}	gate controlled delay time	$V_D = \frac{1}{2} V_{DRM}$	$T_{VJ} = 25^{\circ}\text{C}$		2	μs
		$I_G = 1\text{ A}; di_G/dt = 1\text{ A}/\mu\text{s}$				
t_q	turn-off time	$V_R = 100\text{ V}; I_T = 320\text{ A}; V = \frac{2}{3} V_{DRM}$ $T_{VJ} = 125^{\circ}\text{C}$ $di/dt = 10\text{ A}/\mu\text{s}$ $dv/dt = 50\text{ V}/\mu\text{s}$ $t_p = 200\text{ }\mu\text{s}$		200		μs



Package Y2			Ratings			
Symbol	Definition	Conditions	min.	typ.	max.	Unit
I_{RMS}	RMS current	per terminal			600	A
T_{VJ}	virtual junction temperature		-40		140	°C
T_{op}	operation temperature		-40		125	°C
T_{stg}	storage temperature		-40		125	°C
Weight				255		g
M_D	mounting torque		2.5		5	Nm
M_T	terminal torque		12		15	Nm
$d_{Spp/App}$	creepage distance on surface striking distance through air	terminal to terminal	13.0			mm
$d_{Spb/Apb}$		terminal to backside	13.0			mm
V_{ISOL}	isolation voltage	t = 1 second	3600			V
		t = 1 minute	3000			V

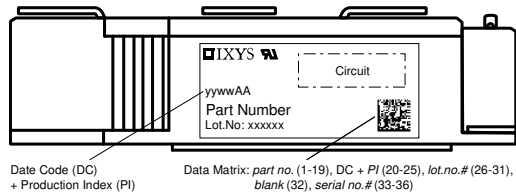

Ordering	Ordering Number	Marking on Product	Delivery Mode	Quantity	Code No.
Standard	MCD310-12io1	MCD310-12io1	Box	2	428787

Equivalent Circuits for Simulation

* on die level

$T_{VJ} = 140^{\circ}C$



Thyristor

$V_{0\ max}$	threshold voltage	0.8	V
$R_{0\ max}$	slope resistance *	0.32	mΩ



Outlines Y2

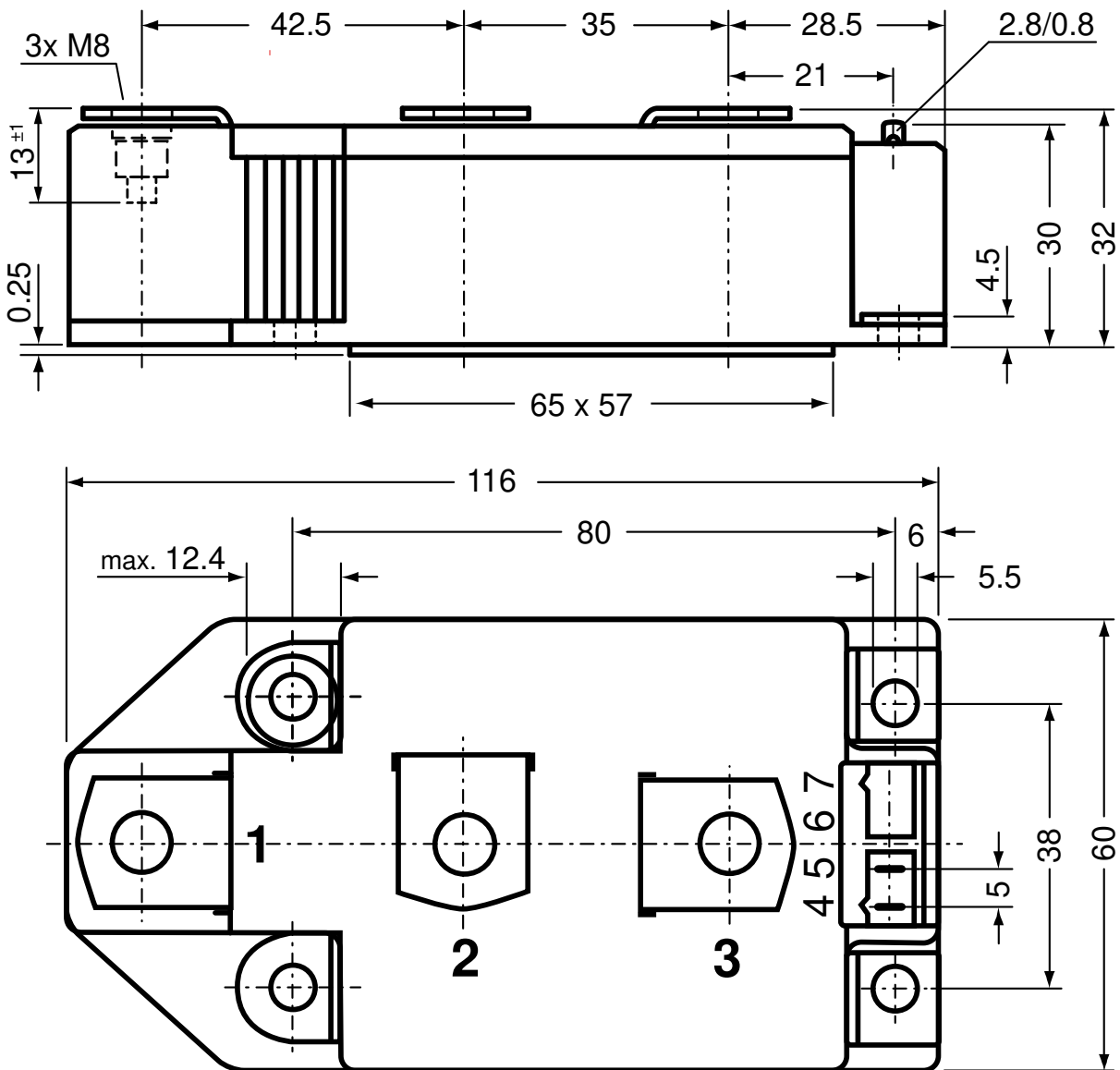

Optional accessories for modules

Keyed gate/cathode twin plugs with wire length = 350 mm, gate = white, cathode = red
Type ZY 180L (L = Left for pin pair 4/5) UL 758, style 3751

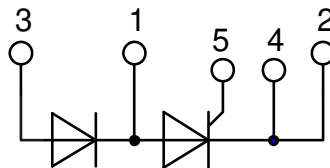



Thyristor

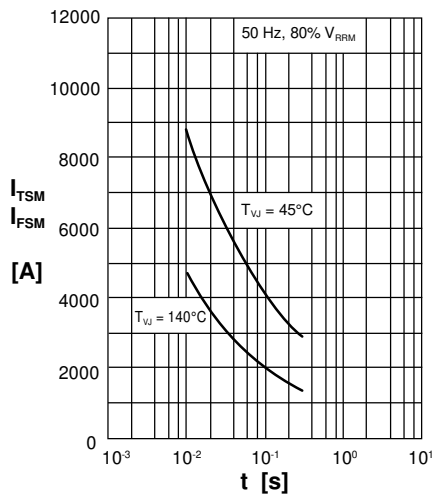

Fig. 1 Surge overload current
 $I_{T(F)SM}$: crest value, t : duration

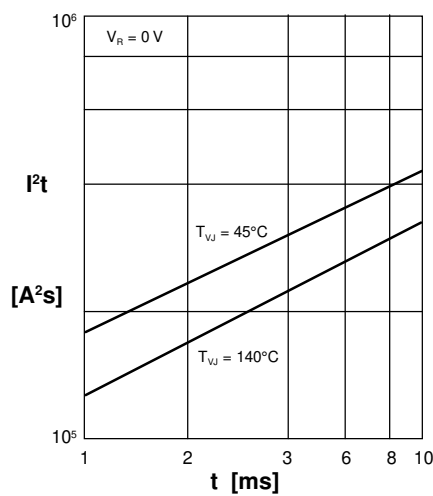

Fig. 2 I^2t versus time (1-10 ms)

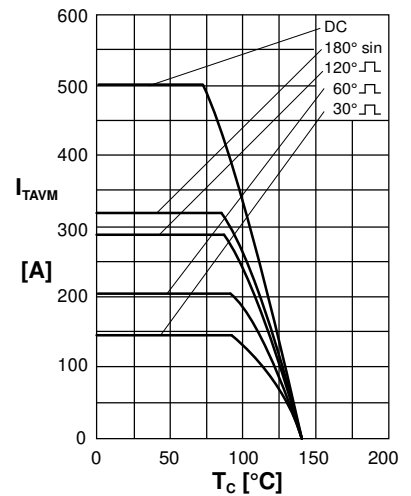

Fig. 3 Max. forward current at case temperature

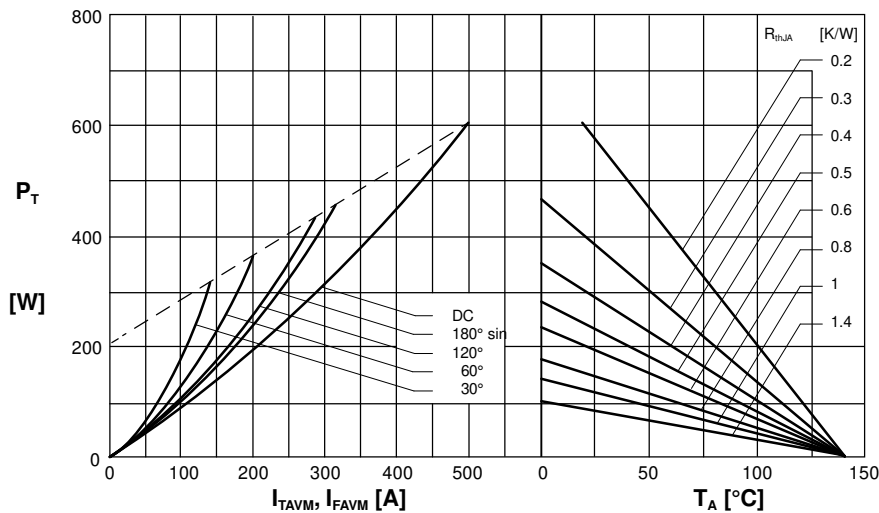

Fig. 4 Power dissipation versus onstate current and ambient temperature (per thyristor/diode)

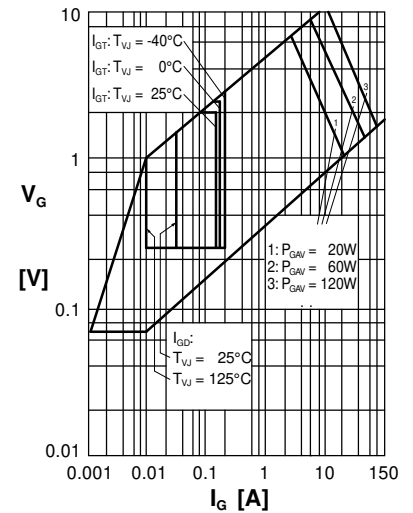

Fig. 5 Gate trigger characteristics

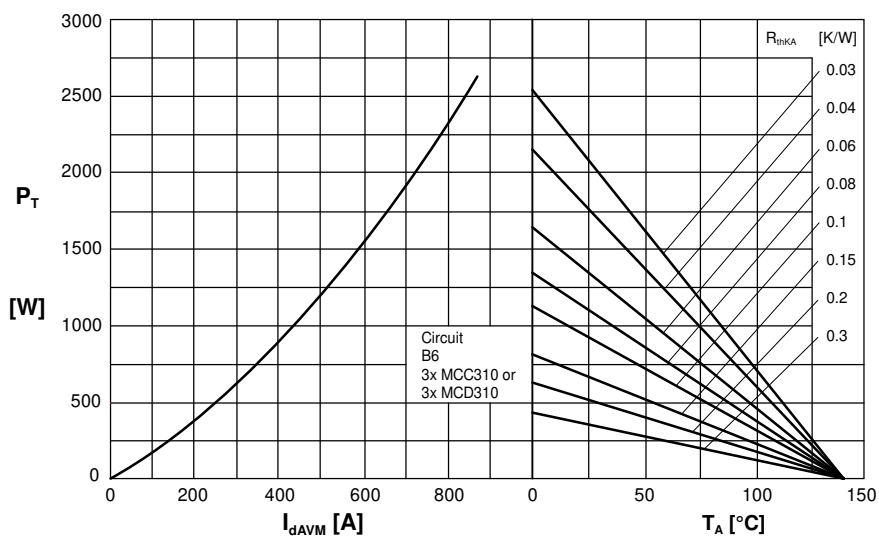

Fig. 6 Three phase rectifier bridge: Power dissipation versus direct output current and ambient temperature

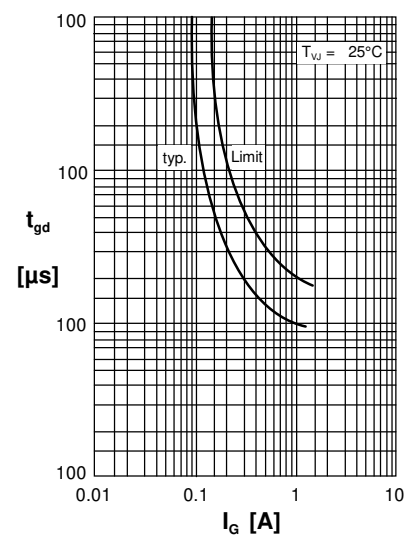

Fig. 7 Gate trigger delay time



Rectifier

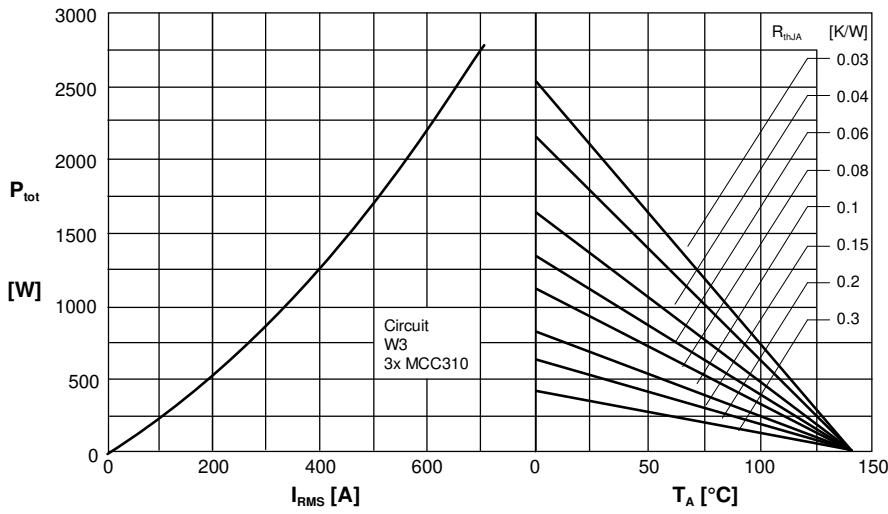

Fig. 7 Three phase AC-controller: • Power dissipation versus RMS output current and ambient temperature

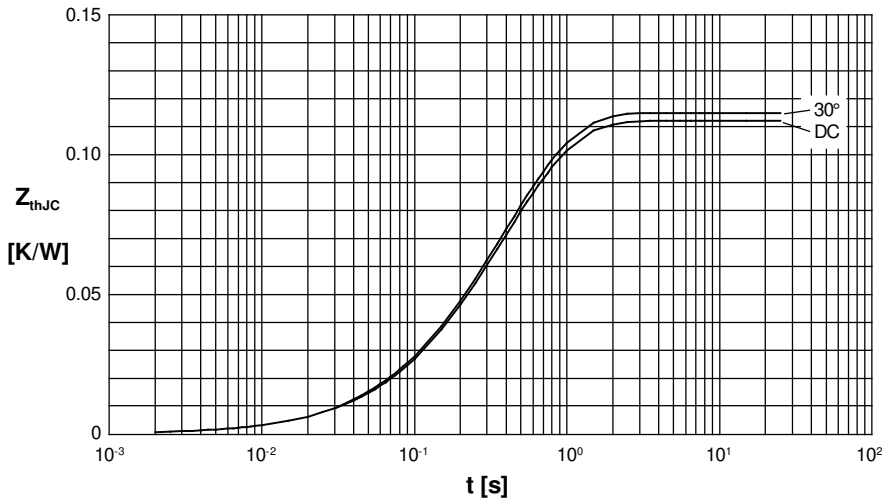

Fig. 8 Transient thermal impedance junction to case (per thyristor)

$R_{\theta JC}$ for various conduction angles d:

d	$R_{\theta JC}$ (K/W)
DC	0.112
180°C	0.113
120°C	0.114
60°C	0.115
30°C	0.115

Constants for $Z_{\theta JC}$ calculation:

i	$R_{\theta i}$ [K/W]	t_i [s]
1	0.003	0.099
2	0.0143	0.168
3	0.0947	0.456

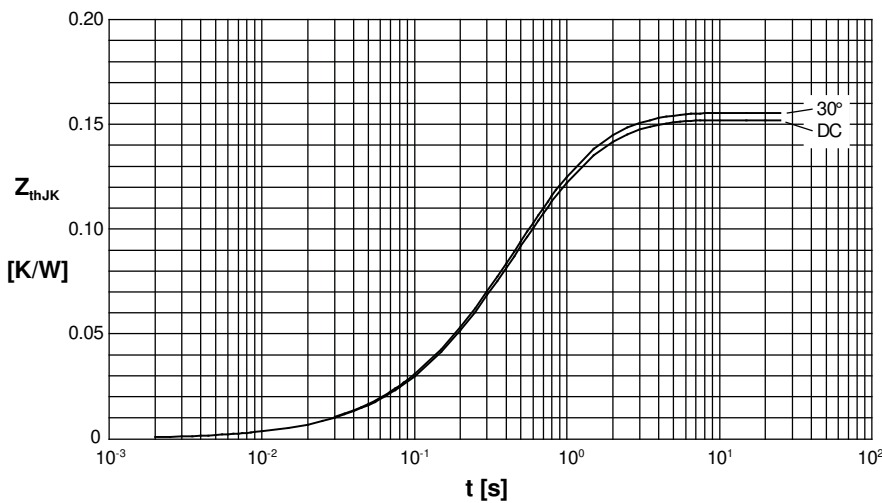

Fig. 9 Transient thermal impedance junction to heatsink (per thyristor)

$R_{\theta JK}$ for various conduction angles d:

d	$R_{\theta JK}$ [K/W]
DC	0.152
180°C	0.154
120°C	0.154
60°C	0.155
30°C	0.155

Constants for $Z_{\theta JK}$ calculation:

i	$R_{\theta i}$ (K/W)	t_i (s)
1	0.003	0.099
2	0.0143	0.168
3	0.0947	0.456
4	0.04	1.36