

Safety Relay SR2M

- 2 pole safety relay with either 1NO+1NC or 2CO contacts
- Forcibly guided contacts according to EN 50205
- Rated current 6 A
- 6 kV surge resistance between poles

Applications

Emergency shut-off, machine control, elevator and escalator control, light barrier control



F0188-D

Approvals

VDE REG.-Nr. 116064, **UL** us E214024, 968/EZ 111.03/05
 Technical data of approved types on request

Contact data

Contact configuration	1 NO contact and 1 NC contact or 2 CO contacts ¹⁾
Contact set	single contact, forcibly guided 1 NC + 1NO: type A according to EN 50205 2 CO: type B according to EN 50205
Type of interruption	micro disconnection
Rated voltage / max. switching voltage AC	250 / 400 VAC
Rated current	6 A
Maximum breaking capacity AC	1500 VA
Contact material	AgNi
Minimum contact load	10 mA / 5 V
Contact resistance	≤ 100 mOhm / 1 A / 24 VDC ≤ 20 Ohm / 10 mA / 5 VDC
Rated frequency of operation with / without load	6 min ⁻¹ / 300 min ⁻¹

¹⁾ According EN50205 only 1NO / 1NC (11-14 and 22-21 or 12-11 and 21-24) shall be used as forcibly guided contacts.

Contact ratings

Type	Contact	Load [*])	Ambient temp. [°C]	Cycles
UL 508				
V23047-A1...-A501	1 NO	B300 pilot duty	40°C	6x10 ³
V23047-A1...-A501	1 NO	R300 pilot duty	40°C	6x10 ³
V23047-A1...-A511	1 NO	B300 pilot duty	40°C	6x10 ³
V23047-A1...-A511	1 NO	R300 pilot duty	40°C	6x10 ³

^{*}) load on one pole

Coil data

Rated coil voltage range DC coil	5...110 VDC
Operative range to IEC 61810	2

Coil versions, DC-coil

Coil code	Rated voltage VDC	Operate voltage VDC	Release voltage VDC	Coil resistance Ohm	Rated coil power mW
005	5	3.8	0.5	35,7 ± 10%	700
006	6	4.5	0.6	51 ± 10%	706
009	9	6.8	0.9	116 ± 10%	698
012	12	9.0	1.2	206 ± 10%	699
015	15	11.3	1.5	321 ± 10%	700
018	18	13.5	1.8	483 ± 10%	671
021	21	15.8	2.1	630 ± 10%	700
024	24	18.0	2.4	823 ± 10%	700
036	36	27.0	3.6	1851 ± 10%	700

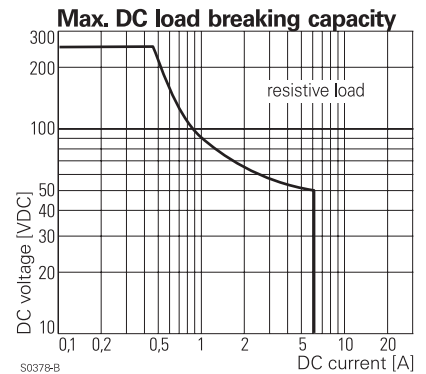

S0378-B

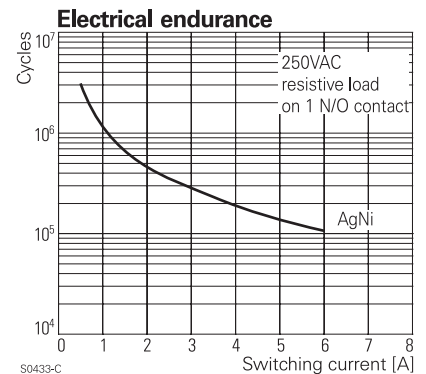

S0433-C

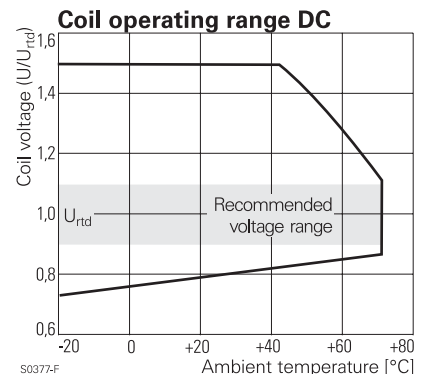

S0377-F

Safety Relay SR2M (Continued)

Coil versions, DC-coil (continued)

Coil code	Rated voltage VDC	Operate voltage VDC	Release voltage VDC	Coil resistance Ohm	Rated coil power mW
040	40	30.0	4.0	2286 ± 10%	700
048	48	36.0	4.8	3291 ± 12%	700
060	60	45.0	6.0	5142 ± 12%	700
080	80	64.0	8.5	9143 ± 12%	700
110	110	82.5	11.0	17285 ± 12%	700

All figures are given for coil without preenergization, at ambient temperature +23°C
Other coil voltages on request

Insulation

Dielectric strength coil-contact circuit	4000 V _{rms}
open contact circuit	1500 V _{rms}
adjacent contact circuits	3000 V _{rms}
Clearance / creepage coil-contact circuit	≥ 8 / 8 mm
adjacent contact circuits	≥ 5.5 / 5.5 mm
Material group of insulation parts	IIIa
Tracking index of relay base	PTI 250
Insulation to IEC 61810-1	
Type of insulation coil-contact circuit	reinforced
open contact circuit	micro disconnection
adjacent contact circuits	basic
Rated insulation voltage	250 V
Pollution degree	2
Rated voltage system	230 / 400 V
Overvoltage category	III
Insulation to EN 50178	
Type of insulation coil-contact circuit	reinforced
adjacent contact circuits	reinforced

Other data

Mechanical endurance	10x10 ⁶ cycles
Material	
RoHS - Directive 2002/95/EC	compliant as per product date code 0407
Environment	
Ambient temperature range	-25...+70 °C
Vibration resistance (function) NO / NC contact	> 10 / 2.5 g, 15...200 Hz
Shock resistance (function) NO / NC contact	> 10 / 5 g, 11 ms half sine
Category of protection	RT III ²⁾
Processing	
Resistance to soldering heat	260°C / 5 s
Relay weight	20 g
Packaging unit	20 pcs

²⁾ please contact technical support for washing parameters

PCB layout / terminal assignment

Bottom view on solder pins

2 CO contacts

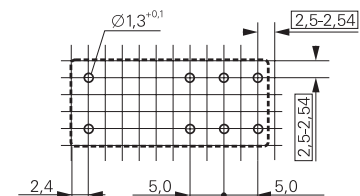

S0163-CO

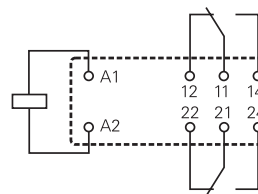

S0163-BJ

1 NO and 1 NC contacts

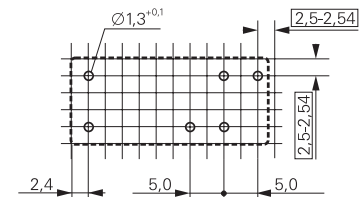

S0163-CU

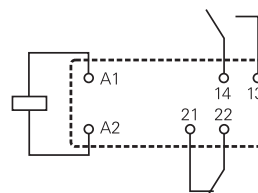

S0163-CV

Dimensions

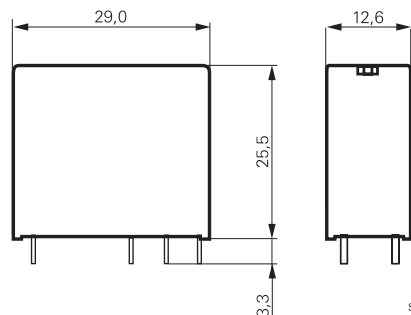

S0273-BB

Safety Relay SR2M (Continued)

Product key	Typical product key	V23047	-A1	012	-A	5	11
Type	V23047 Safety Relay SR2M						
Version	A1 standard						
Coil	Coil code = rated coil voltage (e.g. 024=24 VDC)						
Contact set	A single contact						
Contact material	5 AgNi						
Contact configuration	01 2 CO contacts (2 form C) 11 1 NO and 1 NC contact (1 form A + 1 form B)						

Other types on request

Product key	Version	Contact material	Configuration	Coil	Part number
V23047-A1005-A501	standard	AgNi	2 CO contacts	5 VDC	1393258-2
V23047-A1005-A511	wash tight		1 NO + 1 NC		7-1415006-1
V23047-A1006-A501			2 CO contacts	6 VDC	3-1415011-1
V23047-A1006-A511			1 NO + 1 NC		6-1415011-1
V23047-A1009-A501			2 CO contacts	9 VDC	1393258-3
V23047-A1009-A511			1 NO + 1 NC		7-1415011-1
V23047-A1012-A501			2 CO contacts	12 VDC	1393258-4
V23047-A1012-A511			1 NO + 1 NC		1393258-5
V23047-A1018-A501			2 CO contacts	18 VDC	1393258-8
V23047-A1018-A511			1 NO + 1 NC		1393258-9
V23047-A1021-A501			2 CO contacts	21 VDC	1-1393258-1
V23047-A1021-A511			1 NO + 1 NC		1-1393258-2
V23047-A1024-A501			2 CO contacts	24 VDC	1-1393258-5
V23047-A1024-A511			1 NO + 1 NC		1-1393258-7
V23047-A1036-A501			2 CO contacts	36 VDC	2-1393258-0
V23047-A1036-A511			1 NO + 1 NC		8-1415011-1
V23047-A1040-A501			2 CO contacts	40 VDC	2-1393258-1
V23047-A1040-A511			1 NO + 1 NC		2-1393258-2
V23047-A1048-A501			2 CO contacts	48 VDC	3-1415006-1
V23047-A1048-A511			1 NO + 1 NC		9-1415011-1
V23047-A1060-A511				60 VDC	2-1393258-3
V23047-A1110-A511				110 VDC	2-1415012-1