

RF Power LDMOS Transistor

N-Channel Enhancement-Mode Lateral MOSFET

This 1.26 W RF power LDMOS transistor is designed for cellular base station applications covering the frequency range of 728 to 3600 MHz.

- Typical Single-Carrier W-CDMA Performance: $V_{DD} = 28$ Vdc, $I_{DQ} = 90$ mA, $P_{out} = 1.26$ W Avg., Input Signal PAR = 9.9 dB @ 0.01% Probability on CCDF.(1)

2100 MHz

Frequency	G_{ps} (dB)	η_D (%)	Output PAR (dB)	ACPR (dBc)	IRL (dB)
2110 MHz	21.6	23.2	9.1	-42.0	-11
2140 MHz	21.8	23.0	9.0	-41.5	-15
2170 MHz	21.7	22.6	8.7	-41.7	-15

2300 MHz

Frequency	G_{ps} (dB)	η_D (%)	Output PAR (dB)	ACPR (dBc)	IRL (dB)
2300 MHz	21.2	23.6	9.0	-40.9	-10
2350 MHz	21.6	22.6	8.6	-40.0	-22
2400 MHz	20.7	21.0	8.3	-40.1	-9

2600 MHz

Frequency	G_{ps} (dB)	η_D (%)	Output PAR (dB)	ACPR (dBc)	IRL (dB)
2500 MHz	19.6	22.0	9.8	-44.8	-7
2600 MHz	21.0	22.7	9.4	-41.4	-15
2700 MHz	19.6	21.2	8.9	-39.7	-5

- Typical Single-Carrier W-CDMA Performance: $V_{DD} = 28$ Vdc, $I_{DQ} = 80$ mA, $P_{out} = 1.26$ W Avg., Input Signal PAR = 9.9 dB @ 0.01% Probability on CCDF.(1)

700 MHz

Frequency	G_{ps} (dB)	η_D (%)	Output PAR (dB)	ACPR (dBc)	IRL (dB)
728 MHz	24.3	25.5	9.3	-44.0	-12
748 MHz	24.3	24.7	9.4	-43.9	-12
768 MHz	24.3	23.8	9.5	-43.6	-12

3500 MHz

Frequency	G_{ps} (dB)	η_D (%)	Output PAR (dB)	ACPR (dBc)	IRL (dB)
3400 MHz	14.7	15.8	9.0	-44.9	-7
3500 MHz	16.0	16.8	9.0	-44.9	-8
3600 MHz	15.0	17.4	8.6	-44.2	-4

1. All data measured in fixture with device soldered to heatsink.

Features

- Greater Negative Gate-Source Voltage Range for Improved Class C Operation
- Designed for Digital Predistortion Error Correction Systems
- Universal Broadband Driven Device with Internal RF Feedback

AFT27S010NT1

728–3600 MHz, 1.26 W AVG., 28 V
AIRFAST RF POWER LDMOS
TRANSISTOR

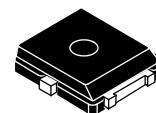

PLD-1.5W
PLASTIC

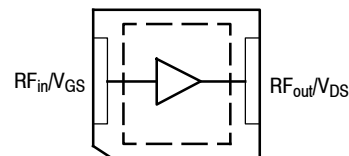

(Top View)

Note: The center pad on the backside of the package is the source terminal for the transistor.

Figure 1. Pin Connections

Table 1. Maximum Ratings

Rating	Symbol	Value	Unit
Drain-Source Voltage	V_{DSS}	-0.5, +65	Vdc
Gate-Source Voltage	V_{GS}	-6.0, +10	Vdc
Operating Voltage	V_{DD}	32, +0	Vdc
Storage Temperature Range	T_{stg}	-65 to +150	°C
Case Operating Temperature Range	T_C	-40 to +150	°C
Operating Junction Temperature Range (1,2)	T_J	-40 to +150	°C

Table 2. Thermal Characteristics

Characteristic	Symbol	Value (2,3)	Unit
Thermal Resistance, Junction to Case Case Temperature 77°C, 1.3 W CW, 28 Vdc, $I_{DQ} = 90$ mA, 2140 MHz	$R_{\theta JC}$	3.5	°C/W

Table 3. ESD Protection Characteristics

Test Methodology	Class
Human Body Model (per JESD22-A114)	1B
Machine Model (per EIA/JESD22-A115)	A
Charge Device Model (per JESD22-C101)	III

Table 4. Moisture Sensitivity Level

Test Methodology	Rating	Package Peak Temperature	Unit
Per JESD22-A113, IPC/JEDEC J-STD-020	3	260	°C

Table 5. Electrical Characteristics ($T_A = 25^\circ\text{C}$ unless otherwise noted)

Characteristic	Symbol	Min	Typ	Max	Unit
----------------	--------	-----	-----	-----	------

Off Characteristics

Zero Gate Voltage Drain Leakage Current ($V_{DS} = 65$ Vdc, $V_{GS} = 0$ Vdc)	I_{DSS}	—	—	10	μAdc
Zero Gate Voltage Drain Leakage Current ($V_{DS} = 28$ Vdc, $V_{GS} = 0$ Vdc)	I_{DSS}	—	—	1	μAdc
Gate-Source Leakage Current ($V_{GS} = 5$ Vdc, $V_{DS} = 0$ Vdc)	I_{GSS}	—	—	1	μAdc

On Characteristics

Gate Threshold Voltage ($V_{DS} = 10$ Vdc, $I_D = 12.1$ μAdc)	$V_{GS(th)}$	0.8	1.2	1.6	Vdc
Gate Quiescent Voltage ($V_{DD} = 28$ Vdc, $I_D = 90$ mAdc, Measured in Functional Test)	$V_{GS(Q)}$	1.5	1.8	2.3	Vdc
Drain-Source On-Voltage ($V_{GS} = 6$ Vdc, $I_D = 121$ mAdc)	$V_{DS(on)}$	0.1	0.2	0.3	Vdc

1. Continuous use at maximum temperature will affect MTTF.
2. MTTF calculator available at <http://www.freescale.com/rtf>. Select Software & Tools/Development Tools/Calculators to access MTTF calculators by product.
3. Refer to AN1955, *Thermal Measurement Methodology of RF Power Amplifiers*. Go to <http://www.freescale.com/rtf>. Select Documentation/Application Notes - AN1955.

(continued)

Table 5. Electrical Characteristics ($T_A = 25^\circ\text{C}$ unless otherwise noted) (continued)

Characteristic	Symbol	Min	Typ	Max	Unit
Functional Tests (In Freescale Test Fixture, 50 ohm system) $V_{DD} = 28\text{ Vdc}$, $I_{DQ} = 90\text{ mA}$, $P_{out} = 1.26\text{ W Avg.}$, $f = 2170\text{ MHz}$, Single-Carrier W-CDMA, IQ Magnitude Clipping, Input Signal PAR = 9.9 dB @ 0.01% Probability on CCDF. ACPR measured in 3.84 MHz Channel Bandwidth @ $\pm 5\text{ MHz}$ Offset.					
Power Gain	G_{ps}	20.0	21.7	—	dB
Drain Efficiency	η_D	18.5	21.5	—	%
Adjacent Channel Power Ratio	ACPR	—	-40.6	-37.9	dBc
Input Return Loss	IRL	—	-14	-9	dB

Load Mismatch (In Freescale Test Fixture, 50 ohm system) $I_{DQ} = 90\text{ mA}$, $f = 2140\text{ MHz}$

VSWR 5:1 at 32 Vdc, 13.9 W CW Output Power (3 dB Input Overdrive from 10 W CW Rated Power)	No Device Degradation
---	-----------------------

Typical Performance (In Freescale Test Fixture, 50 ohm system) $V_{DD} = 28\text{ Vdc}$, $I_{DQ} = 90\text{ mA}$, 2110–2170 MHz Bandwidth

P_{out} @ 1 dB Compression Point, CW	P1dB	—	10	—	W
AM/PM (Maximum value measured at the P3dB compression point across the 2110–2170 MHz frequency range.)	Φ	—	-12.6	—	°
VBW Resonance Point (IMD Seventh Order Intermodulation Inflection Point)	VBW _{res}	—	120	—	MHz
Gain Flatness in 60 MHz Bandwidth @ $P_{out} = 1.26\text{ W Avg.}$	G_F	—	0.20	—	dB
Gain Variation over Temperature (-30°C to $+85^\circ\text{C}$)	ΔG	—	0.011	—	dB/°C
Output Power Variation over Temperature (-30°C to $+85^\circ\text{C}$)	$\Delta P1dB$	—	0.004	—	dB/°C

Table 6. Ordering Information

Device	Tape and Reel Information	Package
AFT27S010NT1	T1 Suffix = 1000 Units, 16 mm Tape Width, 7-inch Reel	PLD-1.5W

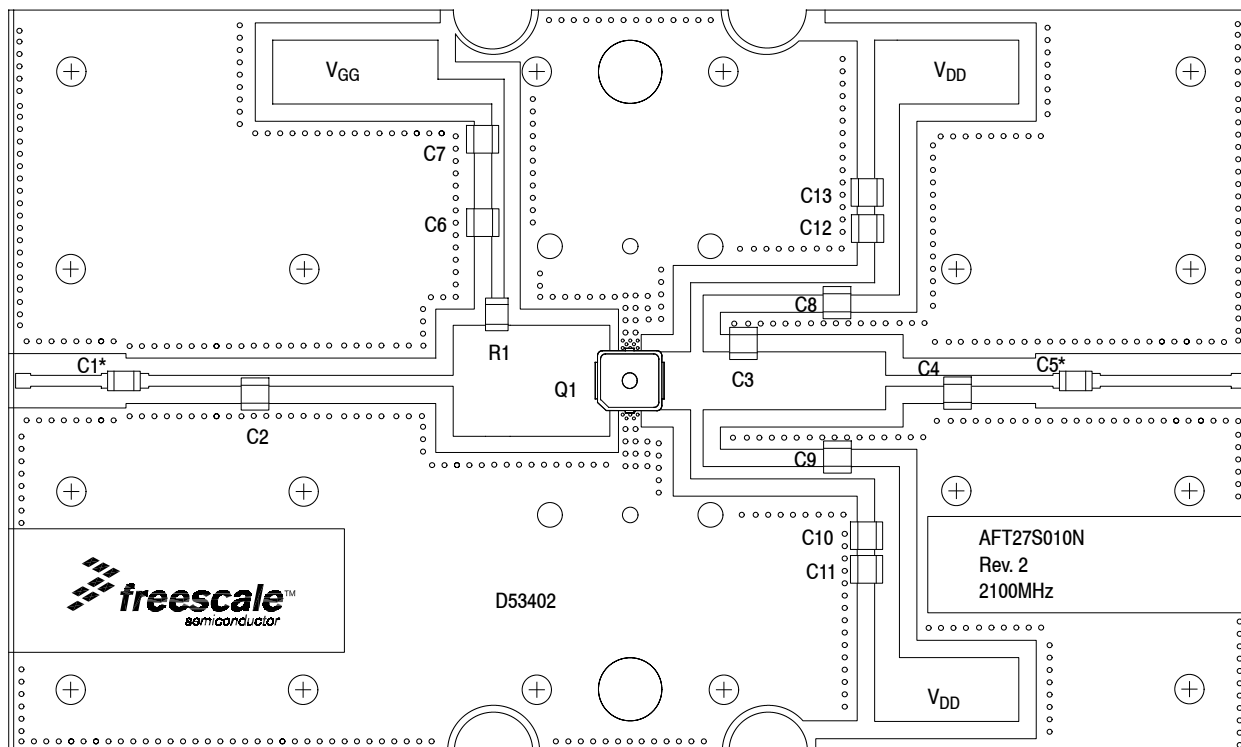

*C1 and C5 are mounted vertically.

NOTE: All data measured in fixture with device soldered to heatsink.

Figure 2. AFT27S010NT1 Test Circuit Component Layout — 2110-2170 MHz

Table 7. AFT27S010NT1 Test Circuit Component Designations and Values — 2110-2170 MHz

Part	Description	Part Number	Manufacturer
C1, C5, C6, C8, C9	9.1 pF Chip Capacitors	ATC100B9R1JT500XT	ATC
C2	1.1 pF Chip Capacitor	ATC100B1R1JT500XT	ATC
C3	2.0 pF Chip Capacitor	ATC100B2R0JT500XT	ATC
C4	1.0 pF Chip Capacitor	ATC100B1R0JT500XT	ATC
C7, C10, C11, C12, C13	10 μ F Chip Capacitors	GRM32ER61H106KA12L	Murata
Q1	RF Power LDMOS Transistor	AFT27S010NT1	Freescale
R1	2.37 Ω Chip Resistor	CRCW12062R37FKEA	Vishay
PCB	Rogers RO4350B, 0.020", $\epsilon_r = 3.66$	D53402	MTL

TYPICAL CHARACTERISTICS — 2110-2170 MHz

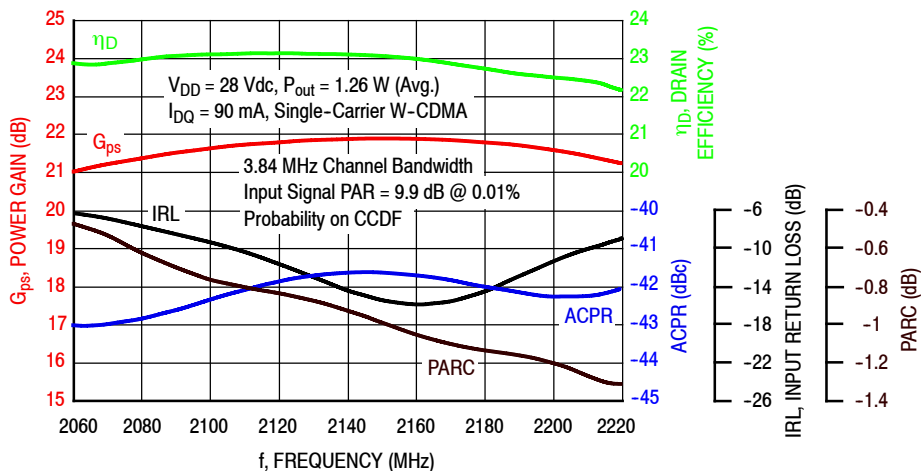

Figure 3. Single-Carrier Output Peak-to-Average Ratio Compression (PARC) Broadband Performance @ $P_{out} = 1.26$ W Avg.

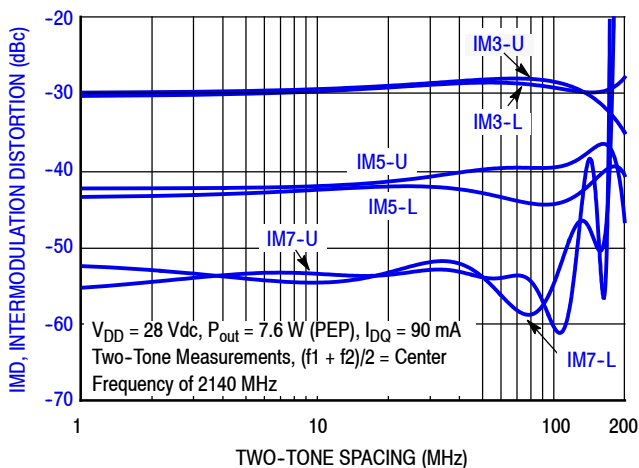

Figure 4. Intermodulation Distortion Products versus Two-Tone Spacing

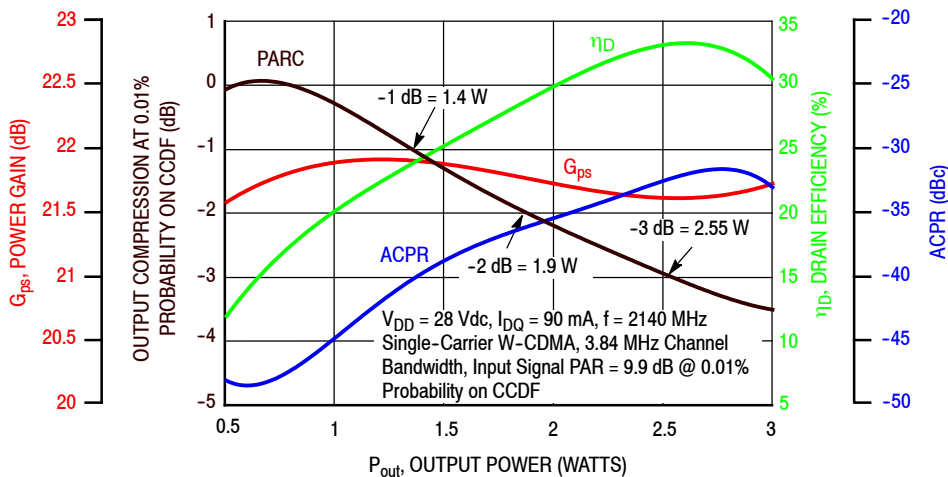

Figure 5. Output Peak-to-Average Ratio Compression (PARC) versus Output Power

TYPICAL CHARACTERISTICS — 2110-2170 MHz

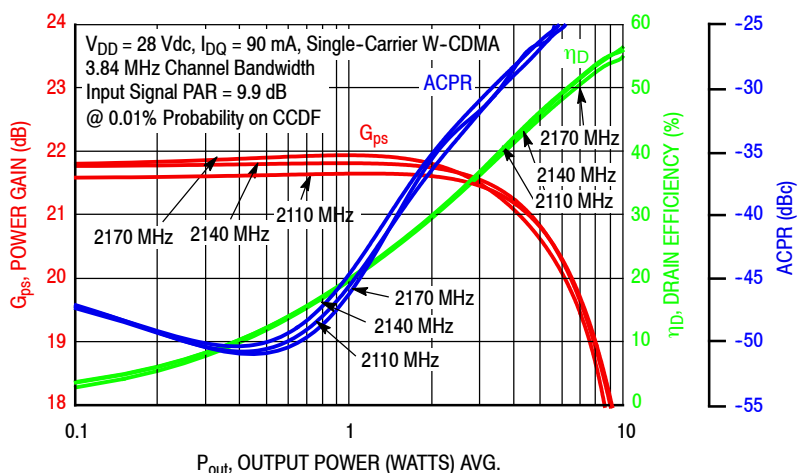

Figure 6. Single-Carrier W-CDMA Power Gain, Drain Efficiency and ACPR versus Output Power

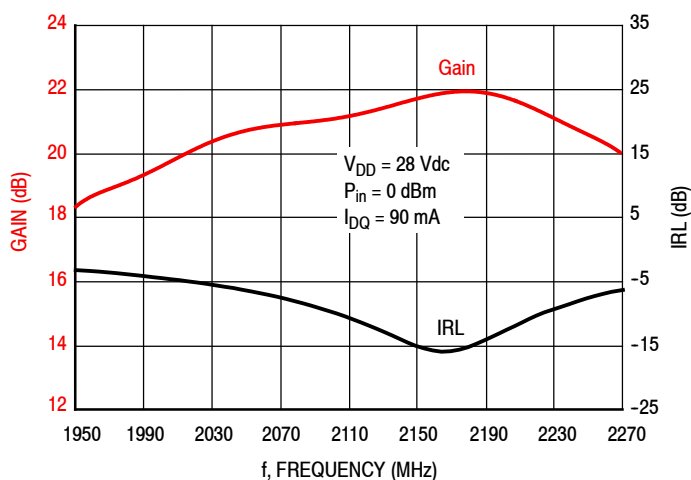

Figure 7. Broadband Frequency Response

Table 8. Load Pull Performance — Maximum Power Tuning
 $V_{DD} = 28 \text{ Vdc}$, $I_{DQ} = 87 \text{ mA}$, Pulsed CW, 10 $\mu\text{sec}(\text{on})$, 10% Duty Cycle

f (MHz)	$Z_{\text{source}} (\Omega)$	$Z_{\text{in}} (\Omega)$	Max Output Power					
			P1dB					
			$Z_{\text{load}}^{(1)} (\Omega)$	Gain (dB)	(dBm)	(W)	η_D (%)	AM/PM (°)
2110	1.23 - j0.107	0.698 + j0.572	5.85 + j3.49	21.0	41.2	13	60.2	-12
2140	1.08 - j0.422	0.877 + j0.537	5.79 + j3.28	20.8	41.2	13	59.5	-13
2170	1.12 - j0.0337	1.26 + j0.455	5.57 + j3.12	20.7	41.1	13	60.1	-11

f (MHz)	$Z_{\text{source}} (\Omega)$	$Z_{\text{in}} (\Omega)$	Max Output Power					
			P3dB					
			$Z_{\text{load}}^{(2)} (\Omega)$	Gain (dB)	(dBm)	(W)	η_D (%)	AM/PM (°)
2110	1.23 - j0.107	0.592 + j0.741	6.75 + j2.96	18.7	42.0	16	59.6	-18
2140	1.08 - j0.422	0.807 + j0.78	6.62 + j2.72	18.5	42.0	16	58.6	-20
2170	1.12 - j0.0337	1.25 + j0.806	6.47 + j2.61	18.4	42.0	16	59.8	-17

(1) Load impedance for optimum P1dB power.

(2) Load impedance for optimum P3dB power.

 Z_{source} = Measured impedance presented to the input of the device at the package reference plane.

 Z_{in} = Impedance as measured from gate contact to ground.

 Z_{load} = Measured impedance presented to the output of the device at the package reference plane.

Table 9. Load Pull Performance — Maximum Drain Efficiency Tuning
 $V_{DD} = 28 \text{ Vdc}$, $I_{DQ} = 87 \text{ mA}$, Pulsed CW, 10 $\mu\text{sec}(\text{on})$, 10% Duty Cycle

f (MHz)	$Z_{\text{source}} (\Omega)$	$Z_{\text{in}} (\Omega)$	Max Drain Efficiency					
			P1dB					
			$Z_{\text{load}}^{(1)} (\Omega)$	Gain (dB)	(dBm)	(W)	η_D (%)	AM/PM (°)
2110	1.23 - j0.107	0.609 + j0.446	3.56 + j6.04	22.7	39.7	9	67.5	-20
2140	1.08 - j0.422	0.736 + j0.434	3.63 + j5.62	22.4	39.9	10	66.6	-21
2170	1.12 - j0.0337	1.03 + j0.312	3.37 + j5.39	22.5	39.6	9	67.3	-19

f (MHz)	$Z_{\text{source}} (\Omega)$	$Z_{\text{in}} (\Omega)$	Max Drain Efficiency					
			P3dB					
			$Z_{\text{load}}^{(2)} (\Omega)$	Gain (dB)	(dBm)	(W)	η_D (%)	AM/PM (°)
2110	1.23 - j0.107	0.512 + j0.627	3.80 + j5.81	20.5	40.5	11	67.3	-29
2140	1.08 - j0.422	0.671 + j0.667	3.77 + j5.41	20.3	40.6	11	65.9	-31
2170	1.12 - j0.0337	1.05 + j0.666	3.83 + j5.15	20.2	40.6	12	67.1	-27

(1) Load impedance for optimum P1dB efficiency.

(2) Load impedance for optimum P3dB efficiency.

 Z_{source} = Measured impedance presented to the input of the device at the package reference plane.

 Z_{in} = Impedance as measured from gate contact to ground.

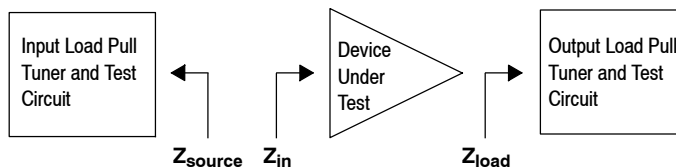
 Z_{load} = Measured impedance presented to the output of the device at the package reference plane.

P1dB - TYPICAL LOAD PULL CONTOURS — 2140 MHz

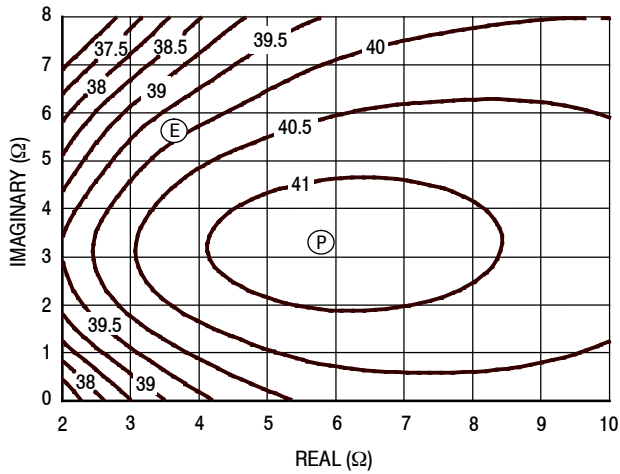

Figure 8. P1dB Load Pull Output Power Contours (dBm)

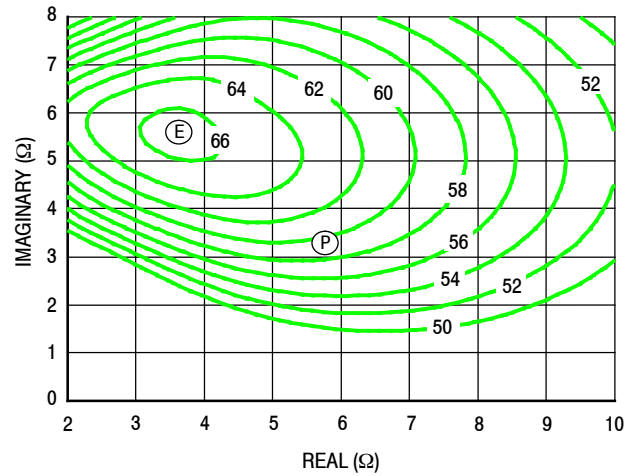

Figure 9. P1dB Load Pull Efficiency Contours (%)

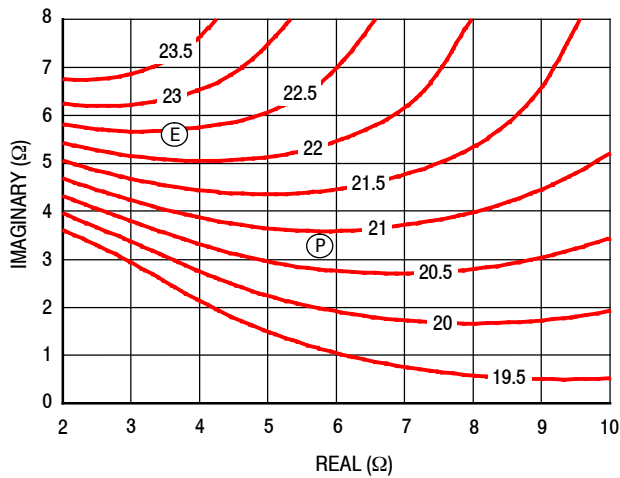

Figure 10. P1dB Load Pull Gain Contours (dB)

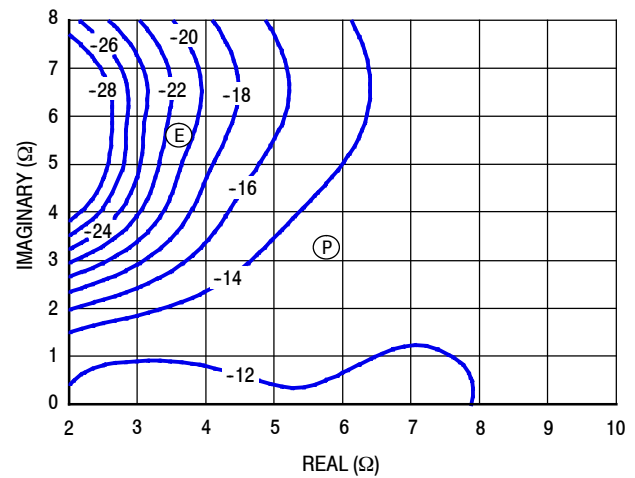

Figure 11. P1dB Load Pull AM/PM Contours (°)

NOTE: (P) = Maximum Output Power
 (E) = Maximum Drain Efficiency

- Gain
- Drain Efficiency
- Linearity
- Output Power

P3dB - TYPICAL LOAD PULL CONTOURS — 2140 MHz

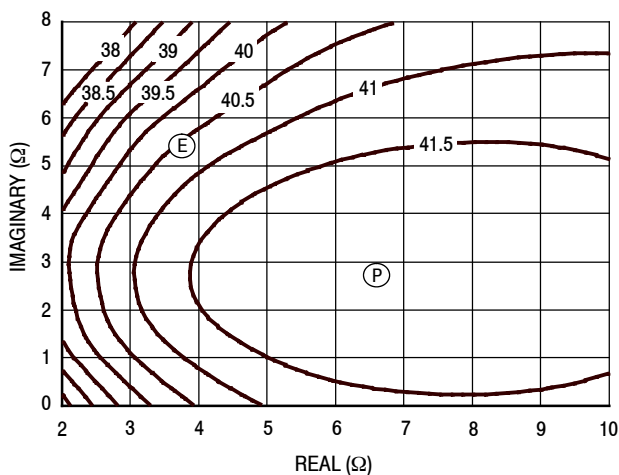

Figure 12. P3dB Load Pull Output Power Contours (dBm)

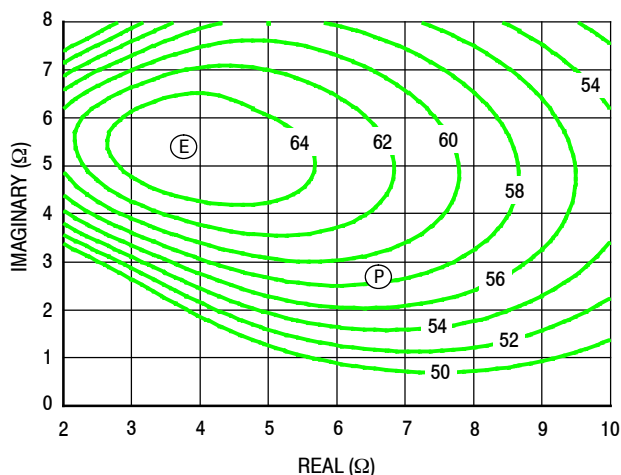

Figure 13. P3dB Load Pull Efficiency Contours (%)

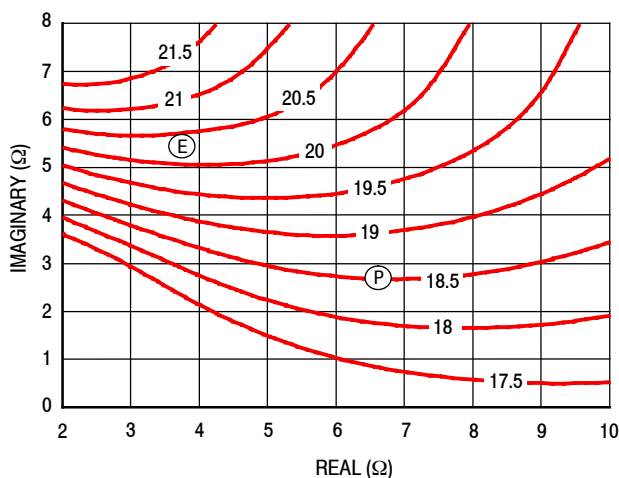

Figure 14. P3dB Load Pull Gain Contours (dB)

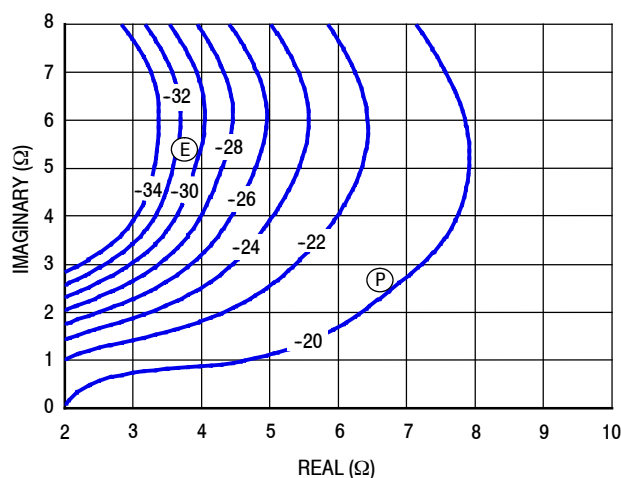
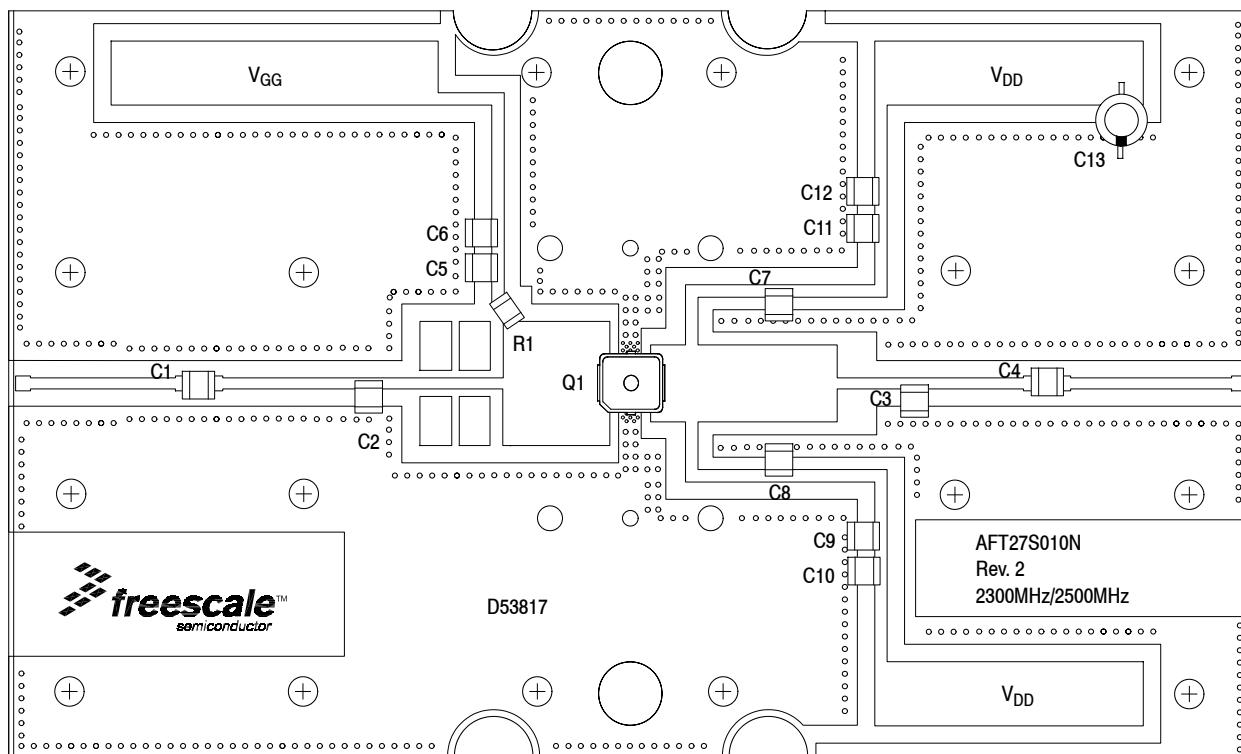

Figure 15. P3dB Load Pull AM/PM Contours (°)

NOTE: (P) = Maximum Output Power
(E) = Maximum Drain Efficiency

- Gain
- Drain Efficiency
- Linearity
- Output Power

2500-2700 MHz



NOTE: All data measured in fixture with device soldered to heatsink.

Figure 16. AFT27S010NT1 Test Circuit Component Layout — 2500-2700 MHz

Table 10. AFT27S010NT1 Test Circuit Component Designations and Values — 2500-2700 MHz

Part	Description	Part Number	Manufacturer
C1, C4, C5, C7, C8	6.8 pF Chip Capacitors	ATC100B6R8JT500XT	ATC
C2	1.2 pF Chip Capacitor	ATC100B1R2JT500XT	ATC
C3	1 pF Chip Capacitor	ATC100B1R0JT500XT	ATC
C6, C9, C10, C11, C12	10 μF Chip Capacitors	GRM32ER61H106KA12L	Murata
C13	220 μF, 50 V Electrolytic Capacitor	227CKS050M	Illinois Capacitor
Q1	RF Power LDMOS Transistor	AFT27S010NT1	Freescale
R1	4.75 Ω Chip Resistor	CRCW12064R75FKEA	Vishay
PCB	Rogers RO4350B, 0.020", ε _r = 3.66	D53817	MTL

TYPICAL CHARACTERISTICS — 2500-2700 MHz

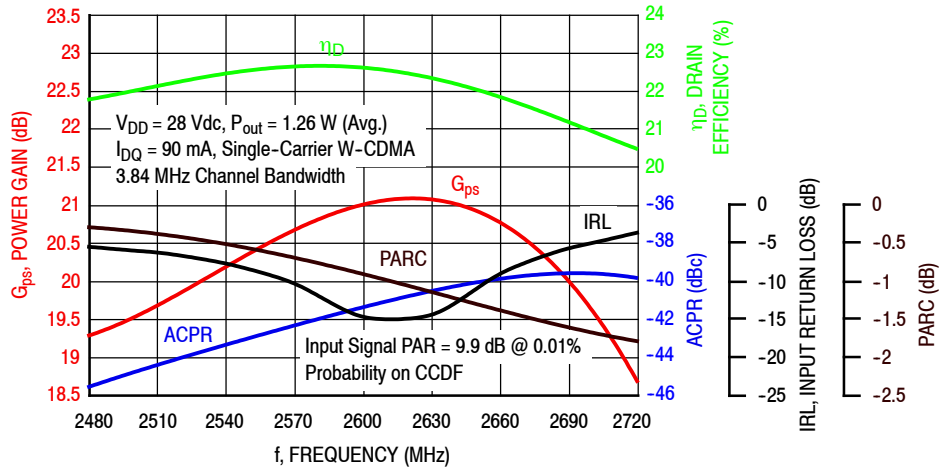

Figure 17. Single-Carrier Output Peak-to-Average Ratio Compression (PARC) Broadband Performance @ $P_{out} = 1.26$ W Avg.

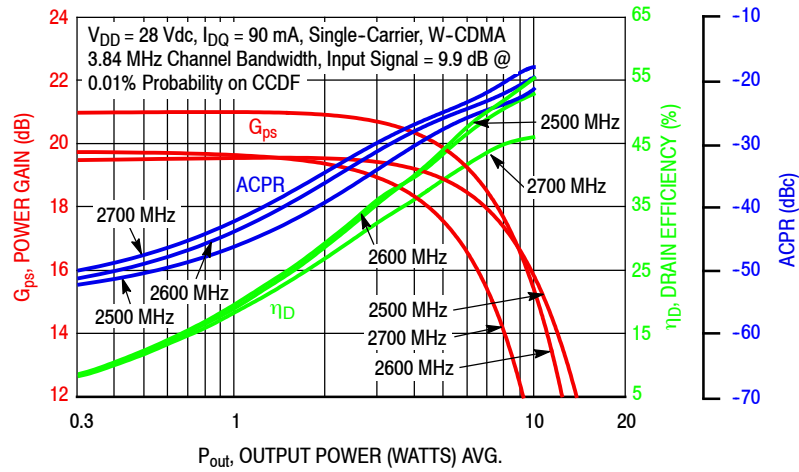

Figure 18. Single-Carrier W-CDMA Power Gain, Drain Efficiency and ACPR versus Output Power

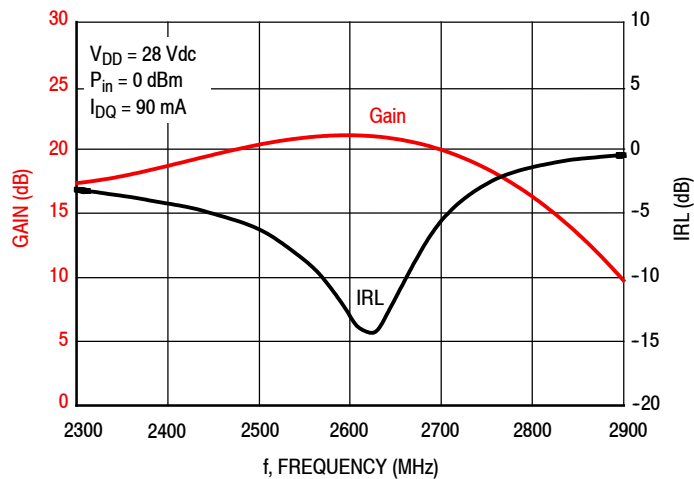
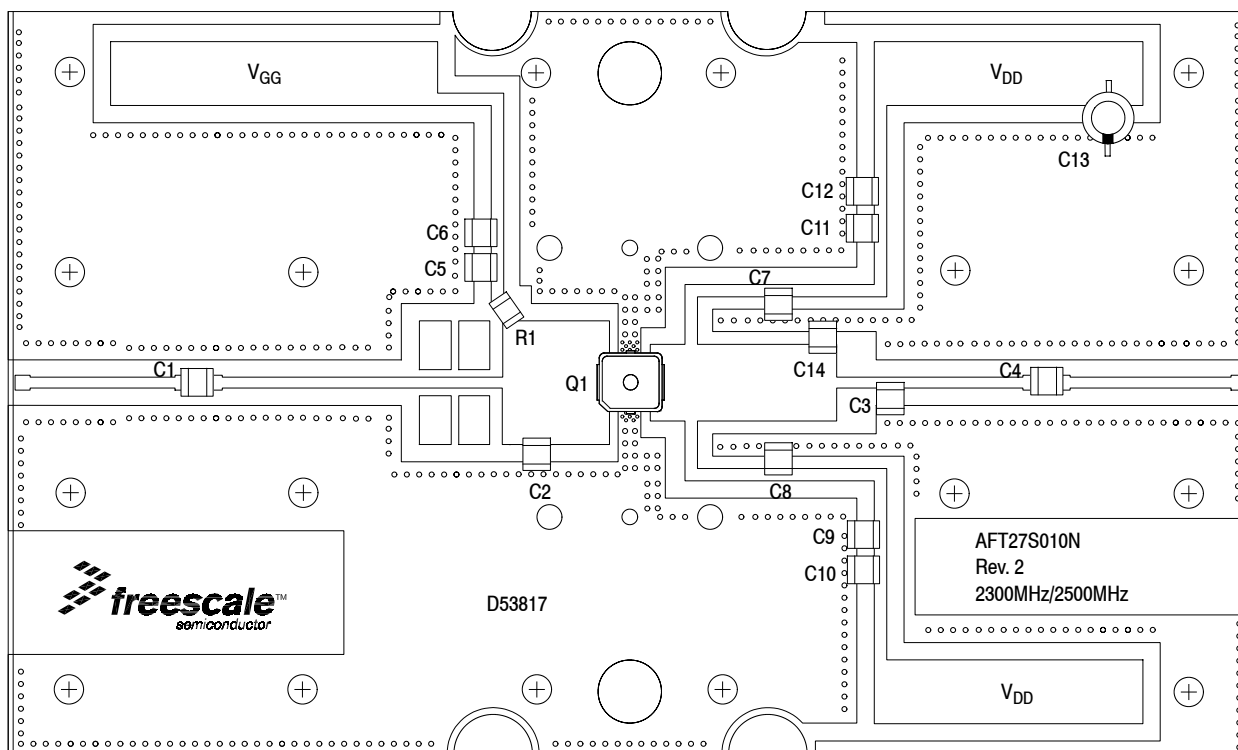

Figure 19. Broadband Frequency Response

2300-2400 MHz



NOTE: All data measured in fixture with device soldered to heatsink.

Figure 20. AFT27S010NT1 Test Circuit Component Layout — 2300-2400 MHz

Table 11. AFT27S010NT1 Test Circuit Component Designations and Values — 2300-2400 MHz

Part	Description	Part Number	Manufacturer
C1, C4, C5, C7, C8	6.8 pF Chip Capacitors	ATC100B6R8JT500XT	ATC
C2, C14	1 pF Chip Capacitors	ATC100B1R0JT500XT	ATC
C3	1.2 pF Chip Capacitor	ATC100B1R2JT500XT	ATC
C6, C9, C10, C11, C12	10 μ F Chip Capacitors	GRM32ER61H106KA12L	Murata
C13	220 μ F, 50 V Electrolytic Capacitor	227CKS050M	Illinois Capacitor
Q1	RF Power LDMOS Transistor	AFT27S010NT1	Freescale
R1	4.75 Ω , Chip Resistor	CRCW12064R75FKEA	Vishay
PCB	Rogers RO4350B, 0.020", $\epsilon_r = 3.66$	D53817	MTL

TYPICAL CHARACTERISTICS — 2300-2400 MHz

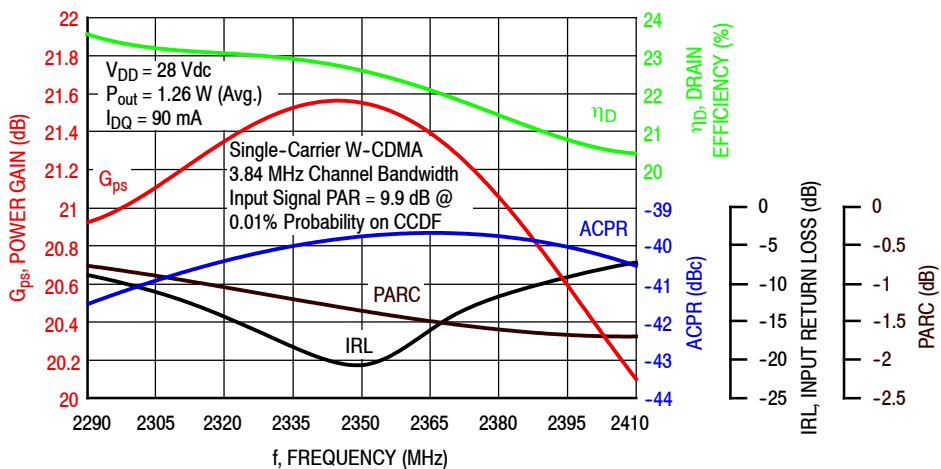

Figure 21. Single-Carrier Output Peak-to-Average Ratio Compression (PARC) Broadband Performance @ $P_{out} = 1.26$ W Avg.

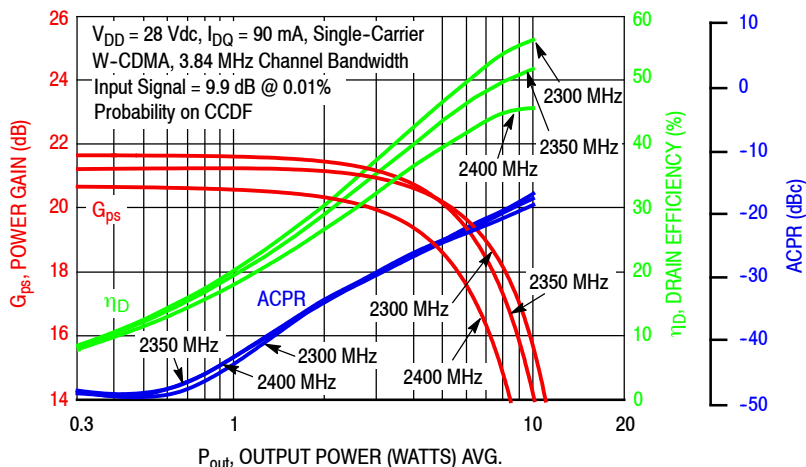

Figure 22. Single-Carrier W-CDMA Power Gain, Drain Efficiency and ACPR versus Output Power

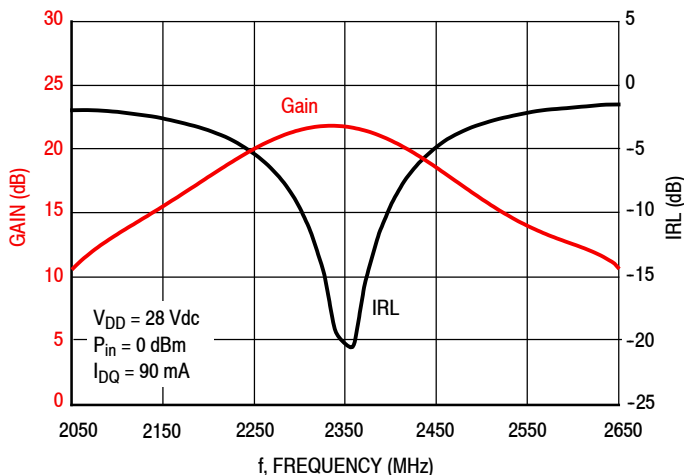

Figure 23. Broadband Frequency Response

Table 12. Load Pull Performance — Maximum Power Tuning
 $V_{DD} = 28 \text{ Vdc}$, $I_{DQ} = 87 \text{ mA}$, Pulsed CW, 10 $\mu\text{sec}(\text{on})$, 10% Duty Cycle

f (MHz)	Z_{source} (Ω)	Z_{in} (Ω)	Max Output Power					
			P1dB					
			$Z_{\text{load}}^{(1)}$ (Ω)	Gain (dB)	(dBm)	(W)	η_D (%)	AM/PM ($^\circ$)
2300	1.12 - j1.10	0.995 + j1.38	5.39 + j2.23	20.1	40.9	12	55.9	-12
2400	1.06 - j1.59	0.948 + j1.96	5.09 + j1.86	19.8	40.9	12	55.1	-12
2500	1.00 - j1.60	1.29 + j1.95	4.51 + j1.56	19.2	40.8	12	55.8	-10
2600	0.985 - j3.50	0.743 + j3.66	4.81 + j1.10	19.0	41.3	13	56.2	-14
2690	1.10 - j3.13	1.48 + j2.98	4.14 + j0.987	19.0	41.0	13	57.5	-12

f (MHz)	Z_{source} (Ω)	Z_{in} (Ω)	Max Output Power					
			P3dB					
			$Z_{\text{load}}^{(2)}$ (Ω)	Gain (dB)	(dBm)	(W)	η_D (%)	AM/PM ($^\circ$)
2300	1.12 - j1.10	0.919 + j1.64	6.28 + j1.74	17.8	41.7	15	55.0	-19
2400	1.06 - j1.59	0.861 + j2.23	5.86 + j1.41	17.5	41.7	15	54.4	-19
2500	1.00 - j1.60	1.37 + j2.32	5.40 + j1.17	16.9	41.7	15	55.8	-17
2600	0.985 - j3.50	0.579 + j3.82	5.37 + j0.912	16.9	42.0	16	55.8	-22
2690	1.10 - j3.13	1.74 + j3.43	5.04 + j0.759	16.8	41.8	15	57.1	-18

(1) Load impedance for optimum P1dB power. (2) Load impedance for optimum P3dB power.

 Z_{source} = Measured impedance presented to the input of the device at the package reference plane.

 Z_{in} = Impedance as measured from gate contact to ground.

 Z_{load} = Measured impedance presented to the output of the device at the package reference plane.

Table 13. Load Pull Performance — Maximum Drain Efficiency Tuning
 $V_{DD} = 28 \text{ Vdc}$, $I_{DQ} = 87 \text{ mA}$, Pulsed CW, 10 $\mu\text{sec}(\text{on})$, 10% Duty Cycle

f (MHz)	Z_{source} (Ω)	Z_{in} (Ω)	Max Drain Efficiency					
			P1dB					
			$Z_{\text{load}}^{(1)}$ (Ω)	Gain (dB)	(dBm)	(W)	η_D (%)	AM/PM ($^\circ$)
2300	1.12 - j1.10	0.855 + j1.22	3.36 + j4.23	21.6	39.8	9	61.9	-20
2400	1.06 - j1.59	0.829 + j1.80	3.34 + j3.53	21.2	39.9	10	60.4	-19
2500	1.00 - j1.60	1.04 + j1.82	3.21 + j3.00	20.8	40.0	10	61.1	-16
2600	0.985 - j3.50	0.709 + j3.49	3.17 + j2.53	20.0	40.5	11	60.7	-20
2690	1.10 - j3.13	1.14 + j2.91	2.87 + j2.16	20.4	40.2	10	62.0	-18

f (MHz)	Z_{source} (Ω)	Z_{in} (Ω)	Max Drain Efficiency					
			P3dB					
			$Z_{\text{load}}^{(2)}$ (Ω)	Gain (dB)	(dBm)	(W)	η_D (%)	AM/PM ($^\circ$)
2300	1.12 - j1.10	0.803 + j1.51	3.96 + j4.10	19.4	40.7	12	61.1	-27
2400	1.06 - j1.59	0.757 + j2.07	3.70 + j3.45	19.1	40.6	12	59.8	-27
2500	1.00 - j1.60	1.15 + j2.18	3.58 + j2.94	18.7	40.8	12	61.2	-24
2600	0.985 - j3.50	0.556 + j3.73	4.15 + j2.29	17.8	41.5	14	59.7	-26
2690	1.10 - j3.13	1.43 + j3.33	3.40 + j2.01	18.2	41.1	13	61.7	-25

(1) Load impedance for optimum P1dB efficiency. (2) Load impedance for optimum P3dB efficiency.

 Z_{source} = Measured impedance presented to the input of the device at the package reference plane.

 Z_{in} = Impedance as measured from gate contact to ground.

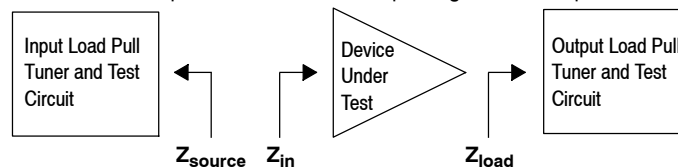
 Z_{load} = Measured impedance presented to the output of the device at the package reference plane.

AFT27S010NT1

P1dB - TYPICAL LOAD PULL CONTOURS — 2500 MHz

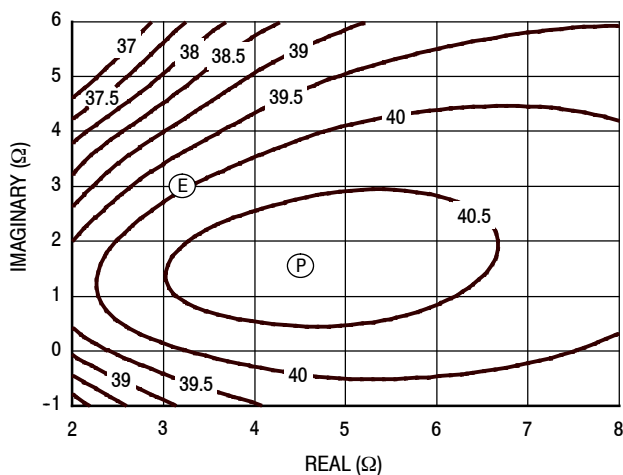

Figure 24. P1dB Load Pull Output Power Contours (dBm)

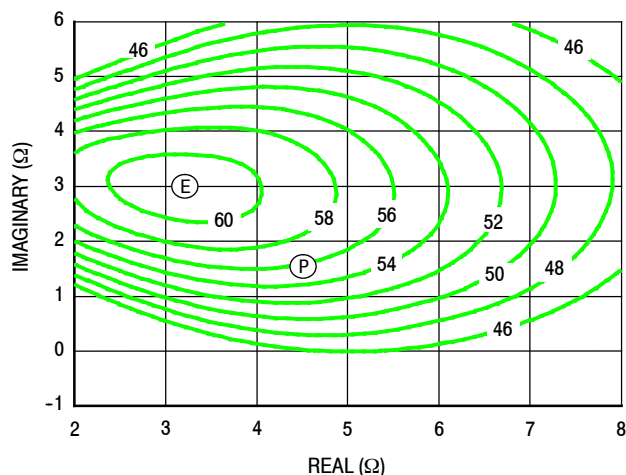

Figure 25. P1dB Load Pull Efficiency Contours (%)

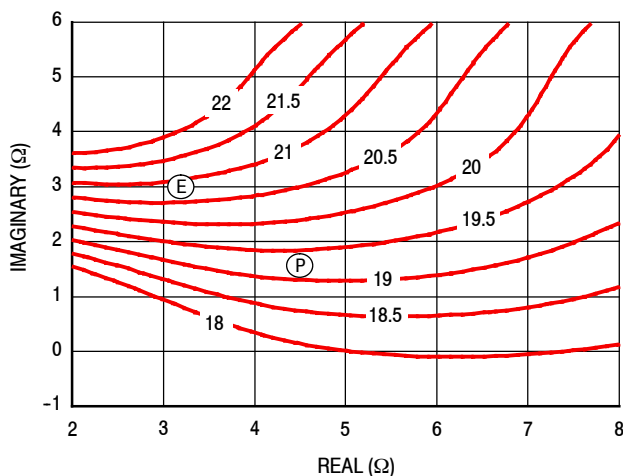

Figure 26. P1dB Load Pull Gain Contours (dB)

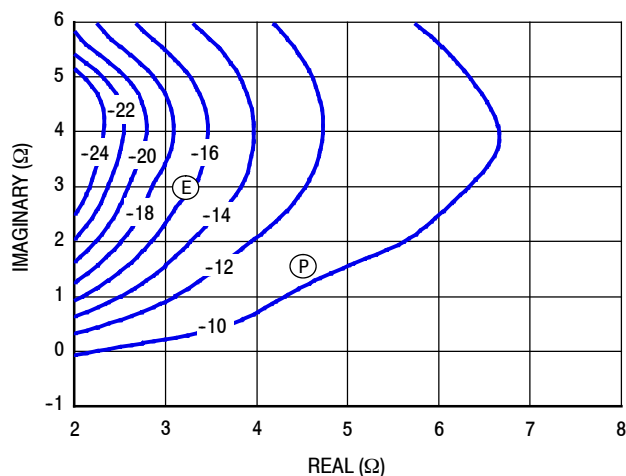

Figure 27. P1dB Load Pull AM/PM Contours (°)

NOTE: (P) = Maximum Output Power
(E) = Maximum Drain Efficiency

- Gain
- Drain Efficiency
- Linearity
- Output Power

P3dB - TYPICAL LOAD PULL CONTOURS — 2500 MHz

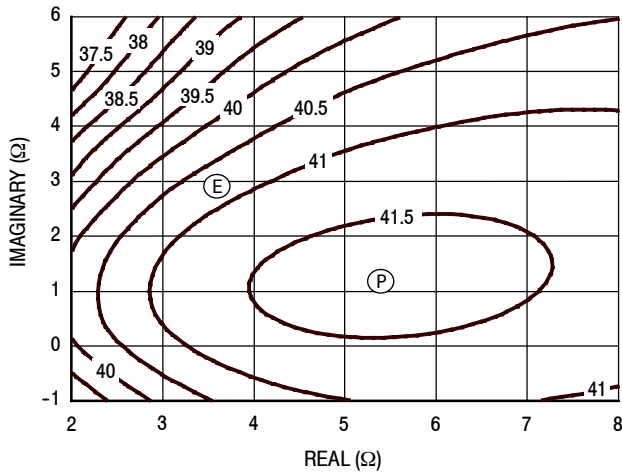

Figure 28. P3dB Load Pull Output Power Contours (dBm)

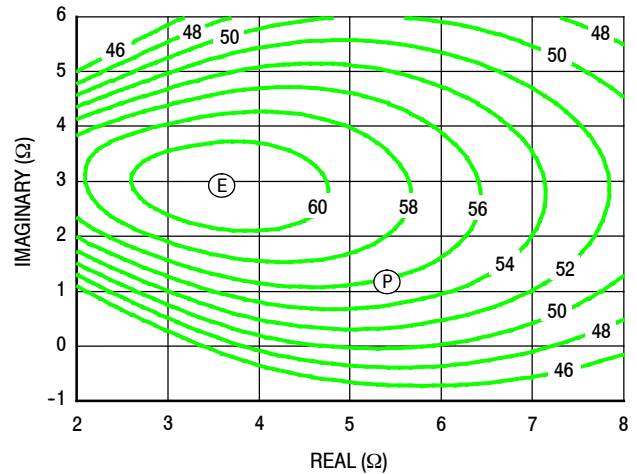

Figure 29. P3dB Load Pull Efficiency Contours (%)

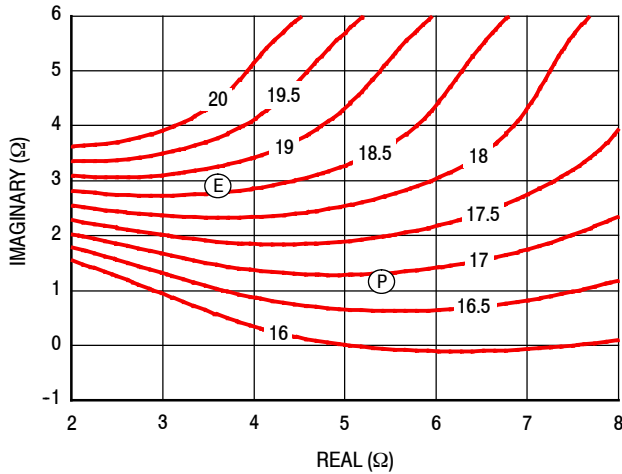

Figure 30. P3dB Load Pull Gain Contours (dB)

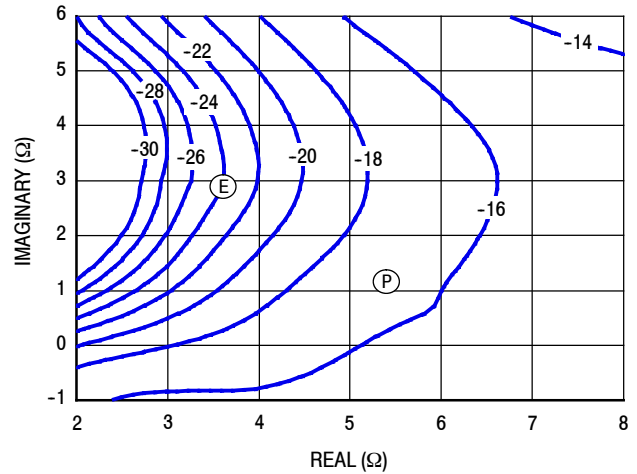

Figure 31. P3dB Load Pull AM/PM Contours (°)

NOTE: (P) = Maximum Output Power
(E) = Maximum Drain Efficiency

- Gain
- Drain Efficiency
- Linearity
- Output Power

TYPICAL CHARACTERISTICS — 3400-3600 MHz

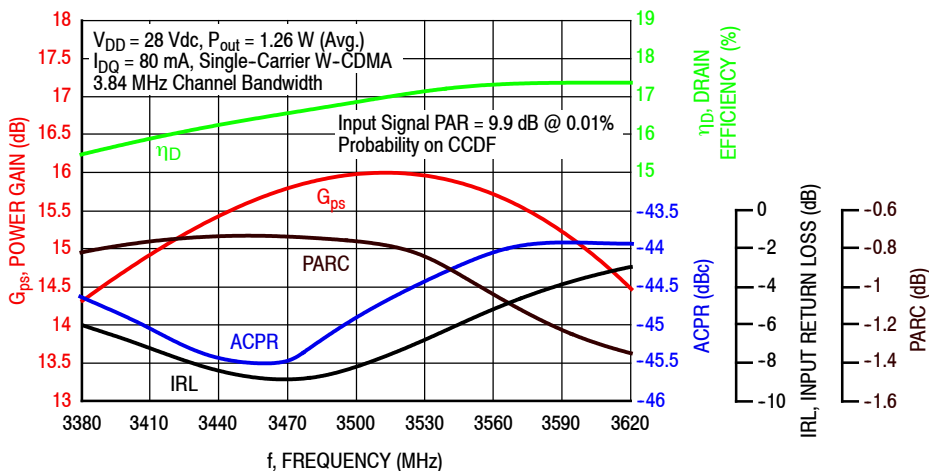

Figure 32. Single-Carrier Output Peak-to-Average Ratio Compression (PARC) Broadband Performance @ $P_{out} = 1.26 \text{ W Avg.}$

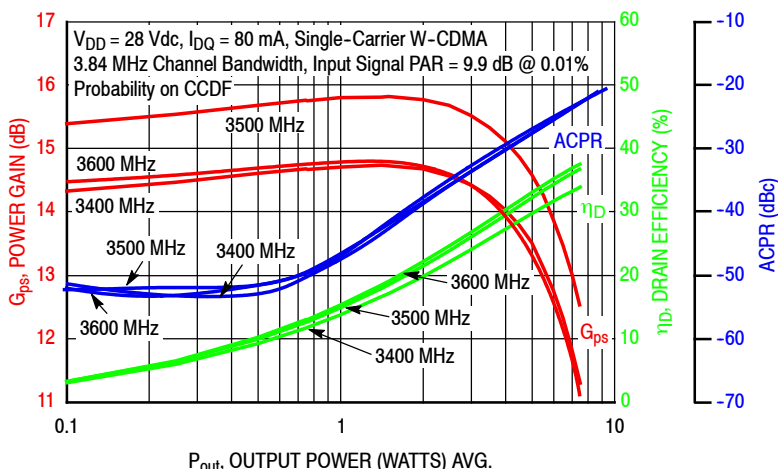

Figure 33. Single-Carrier W-CDMA Power Gain, Drain Efficiency and ACPR versus Output Power

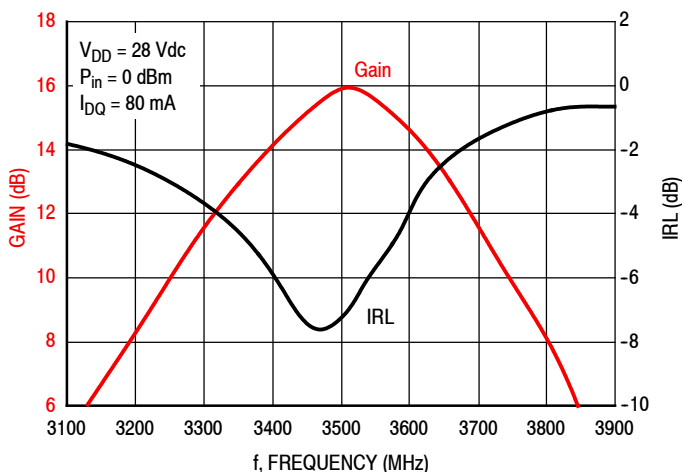
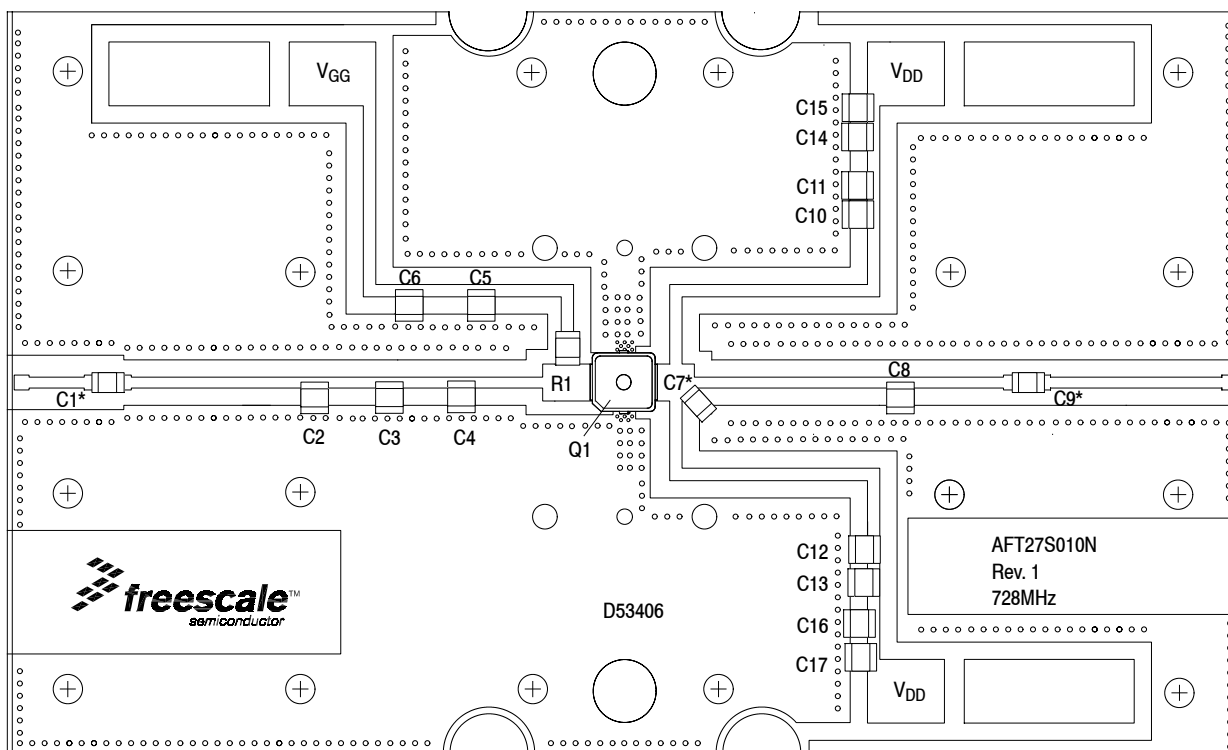

Figure 34. Broadband Frequency Response

728-768 MHz



*C1, C7 and C9 are mounted vertically.

NOTE: All data measured in fixture with device soldered to heatsink.

Figure 35. AFT27S010NT1 Test Circuit Component Layout — 728-768 MHz

Table 14. AFT27S010NT1 Test Circuit Component Designations and Values — 728-768 MHz

Part	Description	Part Number	Manufacturer
C1, C9	82 pF Chip Capacitors	ATC100B820JT500XT	ATC
C2	3.9 pF Chip Capacitor	ATC100B3R9JT500XT	ATC
C3	1.7 pF Chip Capacitor	ATC100B1R7JT500XT	ATC
C4	2.7 pF Chip Capacitor	ATC100B2R7JT500XT	ATC
C5, C10, C11, C12, C13	33 pF Chip Capacitors	ATC100B330JT500XT	ATC
C6, C14, C15, C16, C17	10 μ F Chip Capacitors	GRM32ER61H106KA12L	Murata
C7	3.9 pF Chip Capacitor	ATC100B3R9JT500XT	ATC
C8	0.5 pF Chip Capacitor	ATC100B0R5JT500XT	ATC
Q1	RF Power LDMOS Transistor	AFT27S010NT1	Freescale
R1	10 Ω Chip Resistor	CWCR120610R0JNEA	Vishay
PCB	Rogers RO4350B, 0.020", $\epsilon_r = 3.66$	D53406	MTL

TYPICAL CHARACTERISTICS — 728-768 MHz

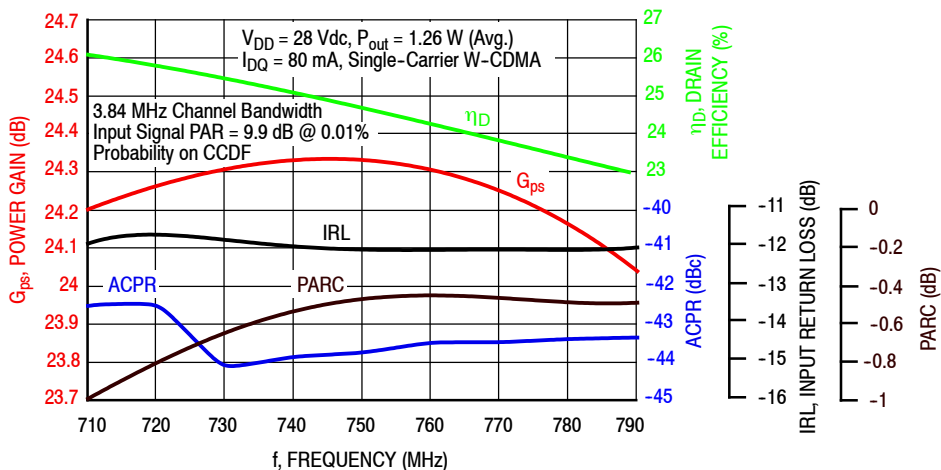

Figure 36. Single-Carrier Output Peak-to-Average Ratio Compression (PARC) Broadband Performance @ $P_{out} = 1.26 \text{ W Avg.}$

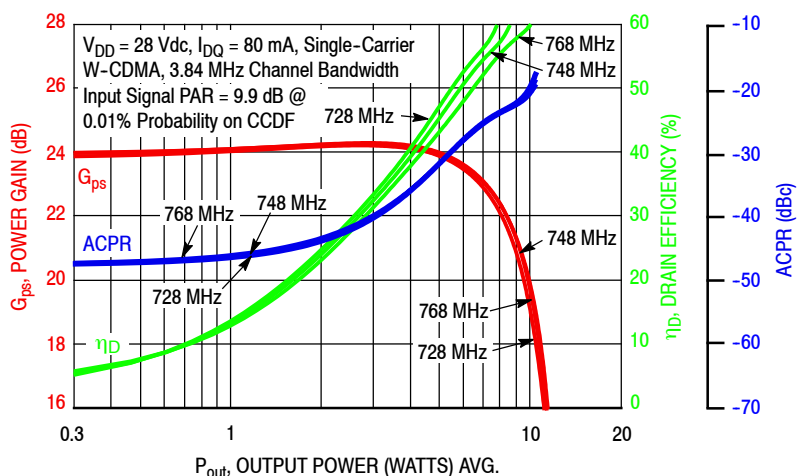

Figure 37. Single-Carrier W-CDMA Power Gain, Drain Efficiency and ACPR versus Output Power

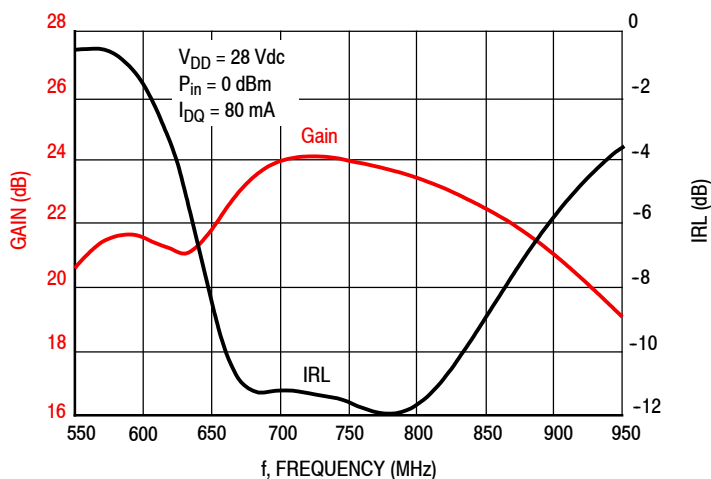

Figure 38. Broadband Frequency Response

Table 15. Load Pull Performance — Maximum Power Tuning
 $V_{DD} = 28 \text{ Vdc}$, $I_{DQ} = 81 \text{ mA}$, Pulsed CW, 10 $\mu\text{sec}(\text{on})$, 10% Duty Cycle

f (MHz)	$Z_{\text{source}} (\Omega)$	$Z_{\text{in}} (\Omega)$	Max Output Power					
			P1dB					
			$Z_{\text{load}}^{(1)} (\Omega)$	Gain (dB)	(dBm)	(W)	η_D (%)	AM/PM (°)
728	$2.05 + j12.1$	$1.72 - j11.7$	$15.1 + j6.07$	27.2	41.3	14	59.8	-15
748	$2.04 + j11.1$	$1.69 - j11.2$	$14.6 + j5.90$	27.0	41.5	14	60.2	-15
768	$1.94 + j10.5$	$1.69 - j10.8$	$14.6 + j5.49$	26.7	41.5	14	60.1	-14

f (MHz)	$Z_{\text{source}} (\Omega)$	$Z_{\text{in}} (\Omega)$	Max Output Power					
			P3dB					
			$Z_{\text{load}}^{(2)} (\Omega)$	Gain (dB)	(dBm)	(W)	η_D (%)	AM/PM (°)
728	$2.05 + j12.1$	$1.53 - j11.7$	$16.1 + j4.43$	24.7	42.3	17	61.9	-17
748	$2.04 + j11.1$	$1.50 - j11.3$	$15.1 + j4.52$	24.6	42.4	17	61.7	-17
768	$1.94 + j10.5$	$1.46 - j10.9$	$14.8 + j4.54$	24.5	42.4	17	61.7	-16

(1) Load impedance for optimum P1dB power.

(2) Load impedance for optimum P3dB power.

 Z_{source} = Measured impedance presented to the input of the device at the package reference plane.

 Z_{in} = Impedance as measured from gate contact to ground.

 Z_{load} = Measured impedance presented to the output of the device at the package reference plane.

Table 16. Load Pull Performance — Maximum Drain Efficiency Tuning
 $V_{DD} = 28 \text{ Vdc}$, $I_{DQ} = 81 \text{ mA}$, Pulsed CW, 10 $\mu\text{sec}(\text{on})$, 10% Duty Cycle

f (MHz)	$Z_{\text{source}} (\Omega)$	$Z_{\text{in}} (\Omega)$	Max Drain Efficiency					
			P1dB					
			$Z_{\text{load}}^{(1)} (\Omega)$	Gain (dB)	(dBm)	(W)	η_D (%)	AM/PM (°)
728	$2.05 + j12.1$	$1.97 - j10.7$	$18.5 + j16.4$	27.9	39.7	9	68.4	-13
748	$2.04 + j11.1$	$1.81 - j9.83$	$16.7 + j20.1$	28.6	38.9	8	68.5	-14
768	$1.94 + j10.5$	$1.83 - j9.69$	$17.4 + j18.0$	28.3	39.5	9	69.2	-14

f (MHz)	$Z_{\text{source}} (\Omega)$	$Z_{\text{in}} (\Omega)$	Max Drain Efficiency					
			P3dB					
			$Z_{\text{load}}^{(2)} (\Omega)$	Gain (dB)	(dBm)	(W)	η_D (%)	AM/PM (°)
728	$2.05 + j12.1$	$1.69 - j10.8$	$18.3 + j18.6$	26.1	40.3	11	73.7	-14
748	$2.04 + j11.1$	$1.58 - j10.4$	$17.5 + j17.5$	26.4	40.5	11	77.4	-14
768	$1.94 + j10.5$	$1.51 - j9.87$	$15.8 + j19.1$	26.8	40.0	10	72.8	-15

(1) Load impedance for optimum P1dB efficiency.

(2) Load impedance for optimum P3dB efficiency.

 Z_{source} = Measured impedance presented to the input of the device at the package reference plane.

 Z_{in} = Impedance as measured from gate contact to ground.

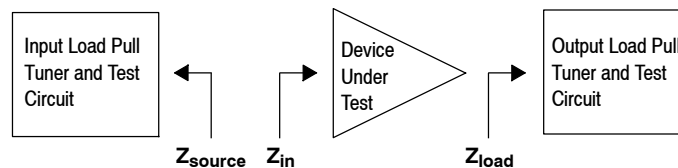
 Z_{load} = Measured impedance presented to the output of the device at the package reference plane.

P1dB - TYPICAL LOAD PULL CONTOURS — 748 MHz

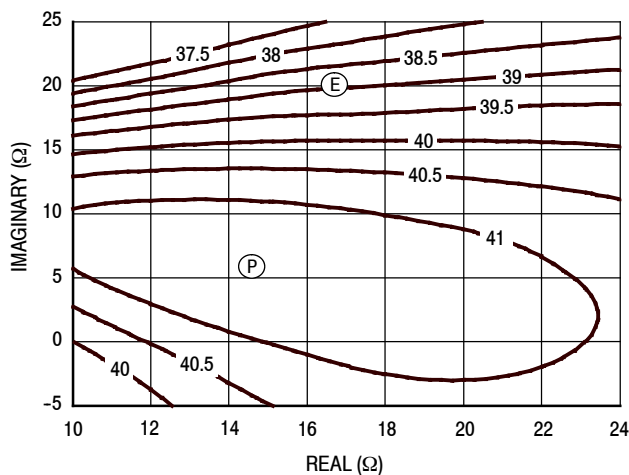

Figure 39. P1dB Load Pull Output Power Contours (dBm)

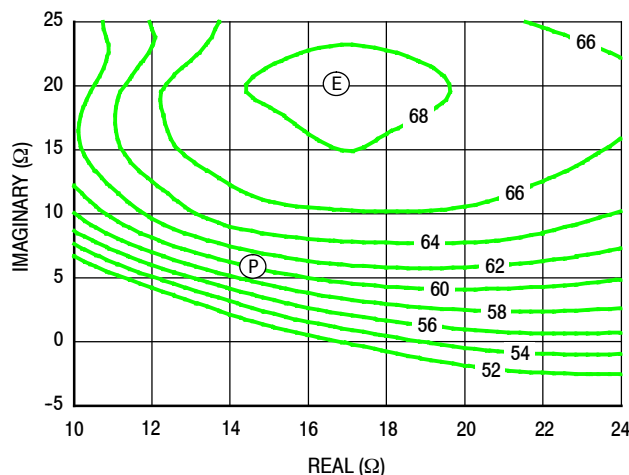

Figure 40. P1dB Load Pull Efficiency Contours (%)

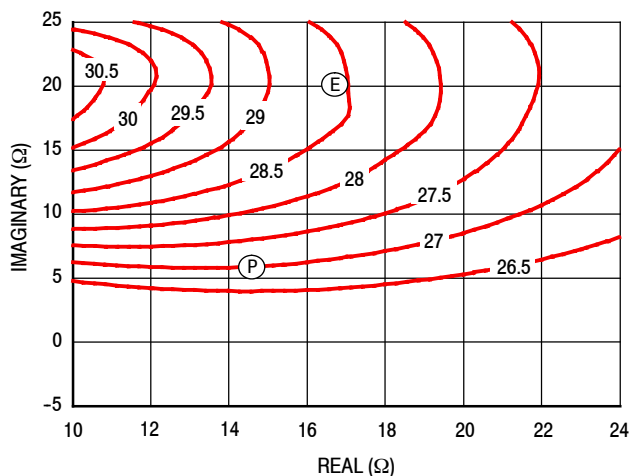

Figure 41. P1dB Load Pull Gain Contours (dB)

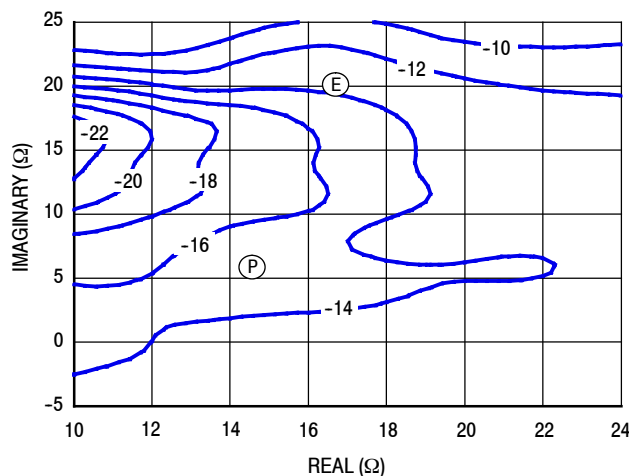

Figure 42. P1dB Load Pull AM/PM Contours (°)

NOTE: (P) = Maximum Output Power
(E) = Maximum Drain Efficiency

- Gain
- Drain Efficiency
- Linearity
- Output Power

P3dB - TYPICAL LOAD PULL CONTOURS — 748 MHz

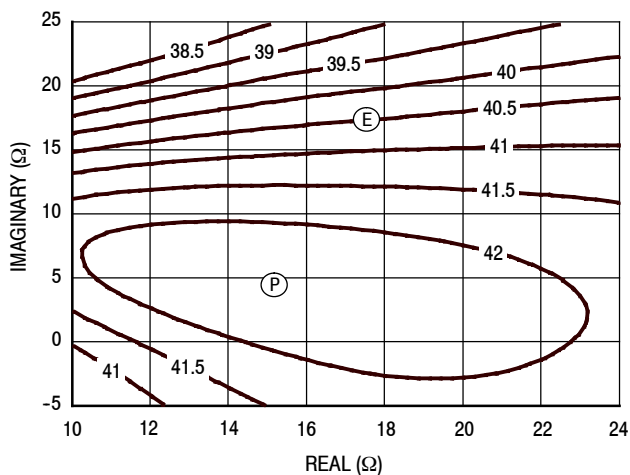

Figure 43. P3dB Load Pull Output Power Contours (dBm)

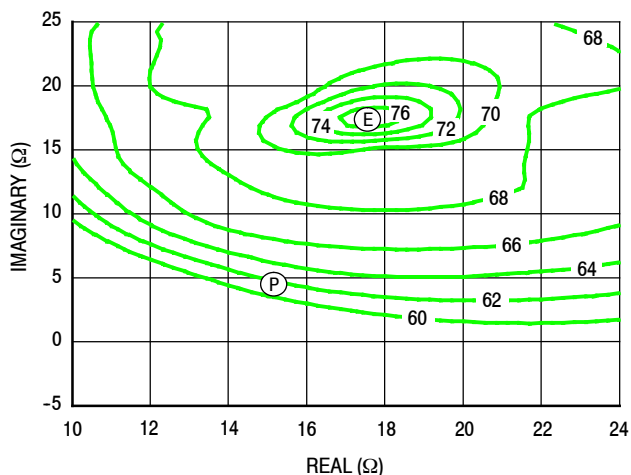

Figure 44. P3dB Load Pull Efficiency Contours (%)

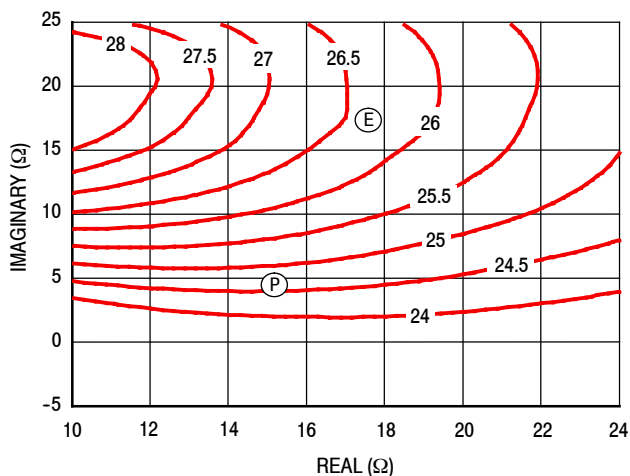

Figure 45. P3dB Load Pull Gain Contours (dB)

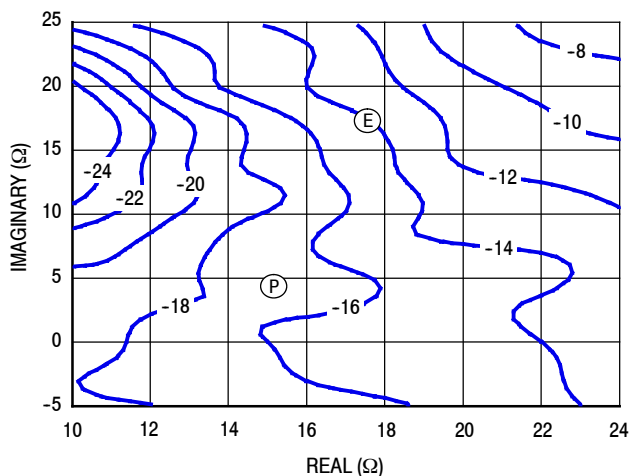

Figure 46. P3dB Load Pull AM/PM Contours (°)

NOTE: (P) = Maximum Output Power
 (E) = Maximum Drain Efficiency

- Gain
- Drain Efficiency
- Linearity
- Output Power

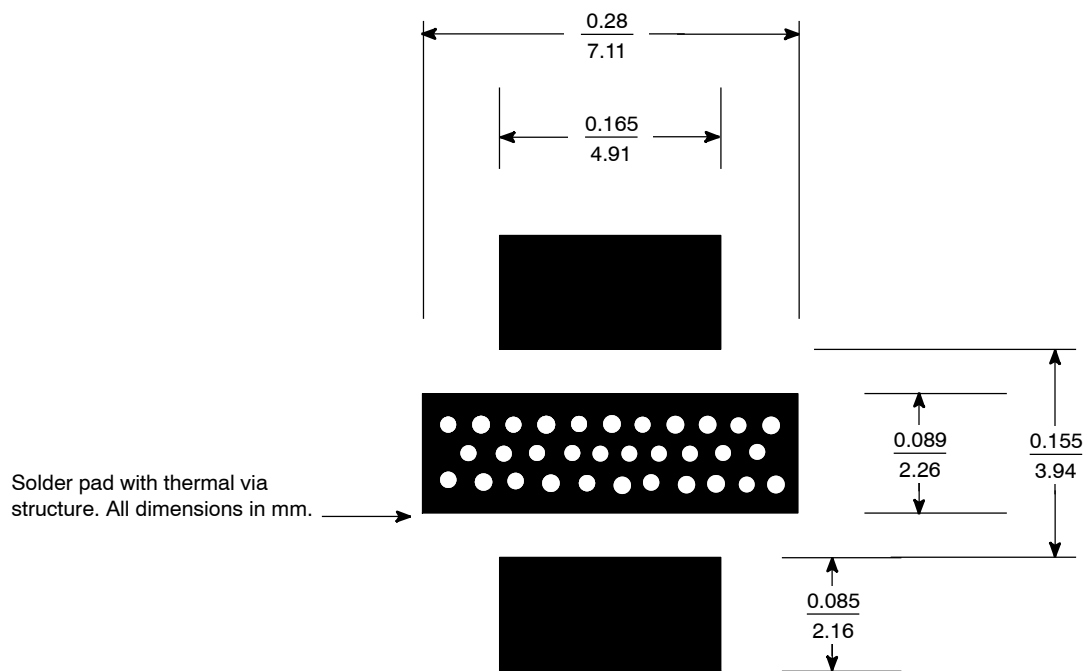
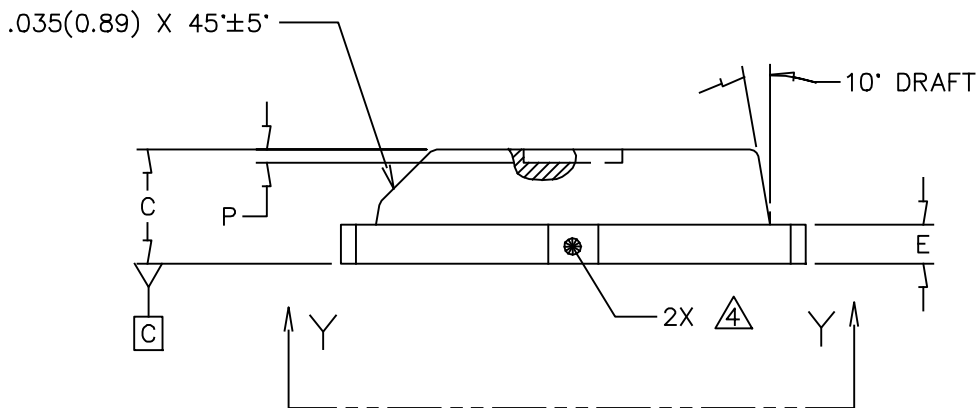
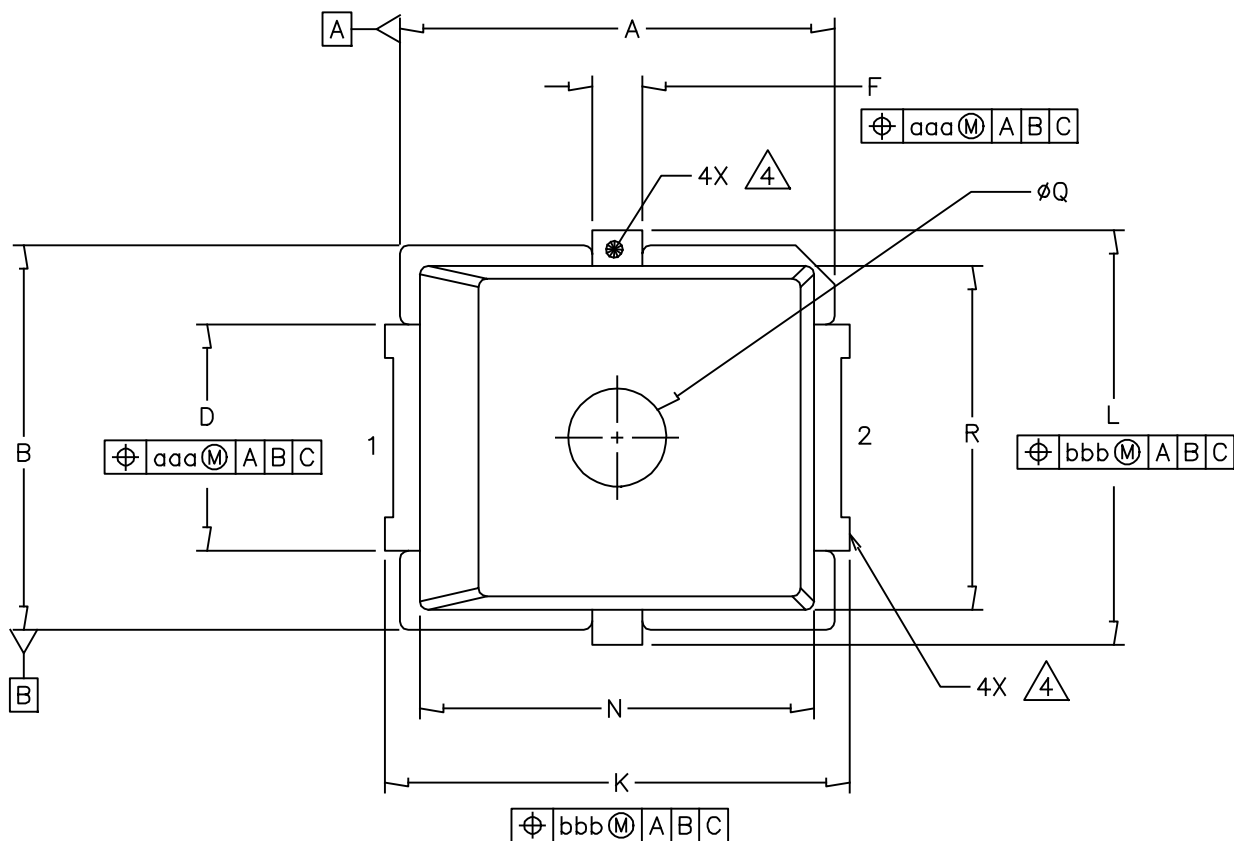

Figure 47. PCB Pad Layout for PLD-1.5W

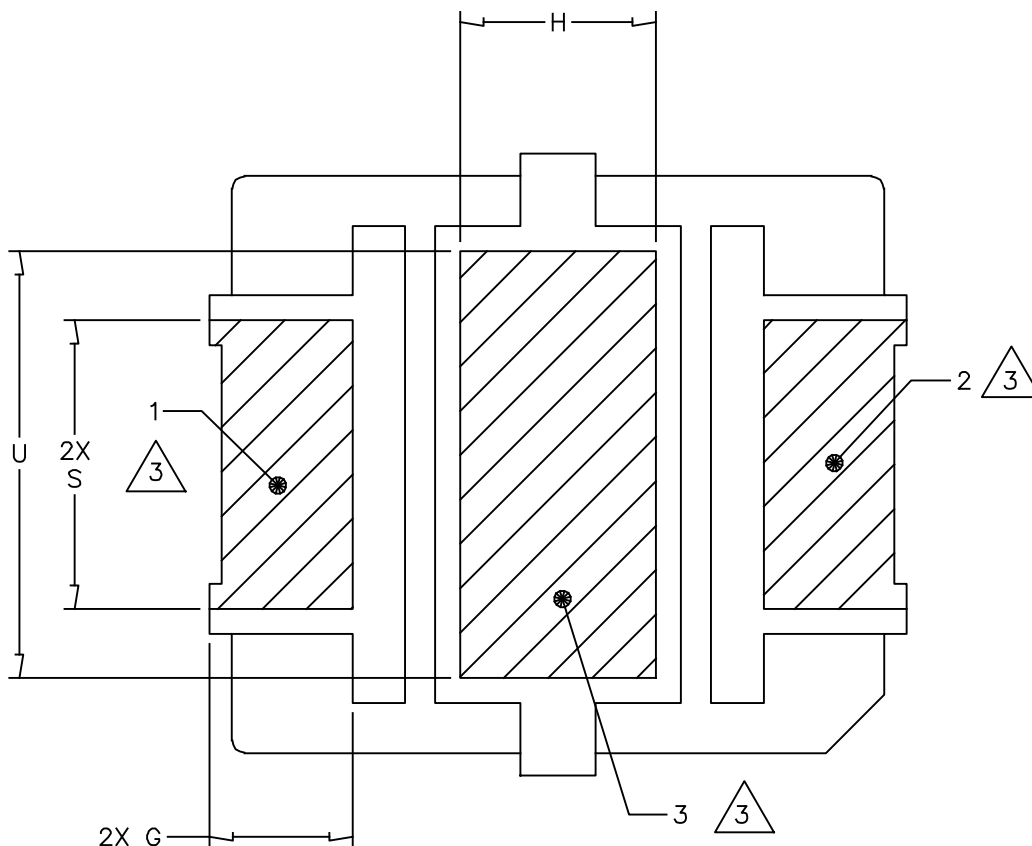

Figure 48. Product Marking

PACKAGE DIMENSIONS



© FREESCALE SEMICONDUCTOR, INC. ALL RIGHTS RESERVED.		MECHANICAL OUTLINE		PRINT VERSION NOT TO SCALE	
TITLE: PLD-1.5W		DOCUMENT NO: 98ASA00476D		REV: 0	
		CASE NUMBER: 2297-01		14 JUN 2012	
		STANDARD: NON-JEDEC			



VIEW Y-Y

© FREESCALE SEMICONDUCTOR, INC. ALL RIGHTS RESERVED.	MECHANICAL OUTLINE	PRINT VERSION NOT TO SCALE	
TITLE: PLD-1.5W	DOCUMENT NO: 98ASA00476D	REV: 0	
	CASE NUMBER: 2297-01	14 JUN 2012	
	STANDARD: NON-JEDEC		

NOTES:

1. CONTROLLING DIMENSION: INCH.
2. INTERPRET DIMENSIONS AND TOLERANCES PER ASME Y14.5M-1994.

3. HATCHING REPRESENTS THE EXPOSED AND SOLDERABLE AREA. DIMENSIONS G, S, H AND U REPRESENT THE VALUES BETWEEN THE TWO OPPOSITE POINTS ALONG THE EDGES OF EXPOSED AREA.

4. THESE SURFACES ARE NOT PART OF THE SOLDERABLE SURFACES AND MAY REMAIN UNPLATED.

DIM	INCH		MILLIMETER		DIM	INCH		MILLIMETER	
	MIN	MAX	MIN	MAX		MIN	MAX	MIN	MAX
A	.255	.265	6.48	6.73	Q	.055	.063	1.40	1.60
B	.225	.235	5.72	5.97	R	.200	.210	5.08	5.33
C	.065	.072	1.65	1.83	S	.110	—	2.79	—
D	.130	.150	3.30	3.81	U	.156	—	3.96	—
E	.021	.026	0.53	0.66	aaa	.004		0.10	
F	.026	.044	0.66	1.12	bbb	.005		0.13	
G	.038	—	0.97	—					
H	.069	—	1.75	—					
J	.160	.180	4.06	4.57					
K	.273	.285	6.93	7.24					
L	.245	.255	6.22	6.48					
N	.230	.240	5.84	6.10					
P	.000	.008	0.00	0.20					
© FREESCALE SEMICONDUCTOR, INC. ALL RIGHTS RESERVED.			MECHANICAL OUTLINE			PRINT VERSION NOT TO SCALE			
TITLE: PLD-1.5W					DOCUMENT NO: 98ASA00476D			REV: 0	
					CASE NUMBER: 2297-01			14 JUN 2012	
					STANDARD: NON-JEDEC				

Refer to the following resources to aid your design process.

Application Notes

- AN1955: Thermal Measurement Methodology of RF Power Amplifiers

Software

- Electromigration MTTF Calculator
- RF High Power Model
- .s2p File

Development Tools

- Printed Circuit Boards

For Software and Tools, do a Part Number search at <http://www.freescale.com>, and select the “Part Number” link. Go to Software & Tools on the part’s Product Summary page to download the respective tool.

REVISION HISTORY

The following table summarizes revisions to this document.

Revision	Date	Description
0	Nov. 2013	<ul style="list-style-type: none"> • Initial Release of Data Sheet
1	Sept. 2014	<ul style="list-style-type: none"> • Tape and Reel information: corrected tape width information from 13-inch reel to 7-inch reel to reflect actual reel size, p. 1 • Changed operating frequency from 728–2700 MHz to 728–3600 MHz due to expanded device frequency capability resulting from additional test data, p. 1
2	Nov. 2014	<ul style="list-style-type: none"> • Added 3400–3600 MHz performance information as follows: <ul style="list-style-type: none"> - Typical Frequency Band table, p. 1 - Fig. 32, Single-Carrier Output Peak-to-Average Ratio Compression (PARC) Broadband Performance @ $P_{out} = 1.26\text{ W Avg.}$, p. 17 - Fig. 33, Single-Carrier W-CDMA Power Gain, Drain Efficiency and ACPR versus Output Power, p. 17 - Fig. 34, Broadband Frequency Response, p. 17
3	Dec. 2015	<ul style="list-style-type: none"> • Table 1, Maximum Ratings: corrected operating junction temperature range upper limit, p. 2 • Table 5, Electrical Characteristics, On Characteristics $V_{DS(on)}$: updated I_D unit of measure to mA_{dc} to reflect actual unit of measure, p. 2 • Added Ordering Information Table 6, p. 3

How to Reach Us:

Home Page:
freescale.com

Web Support:
freescale.com/support

Information in this document is provided solely to enable system and software implementers to use Freescale products. There are no express or implied copyright licenses granted hereunder to design or fabricate any integrated circuits based on the information in this document.

Freescale reserves the right to make changes without further notice to any products herein. Freescale makes no warranty, representation, or guarantee regarding the suitability of its products for any particular purpose, nor does Freescale assume any liability arising out of the application or use of any product or circuit, and specifically disclaims any and all liability, including without limitation consequential or incidental damages. "Typical" parameters that may be provided in Freescale data sheets and/or specifications can and do vary in different applications, and actual performance may vary over time. All operating parameters, including "typicals," must be validated for each customer application by customer's technical experts. Freescale does not convey any license under its patent rights nor the rights of others. Freescale sells products pursuant to standard terms and conditions of sale, which can be found at the following address: freescale.com/SalesTermsandConditions.

Freescale and the Freescale logo are trademarks of Freescale Semiconductor, Inc., Reg. U.S. Pat. & Tm. Off. Airfast is a trademark of Freescale Semiconductor, Inc. All other product or service names are the property of their respective owners.

© 2013–2015 Freescale Semiconductor, Inc.