

PACKAGE DIMENSIONS

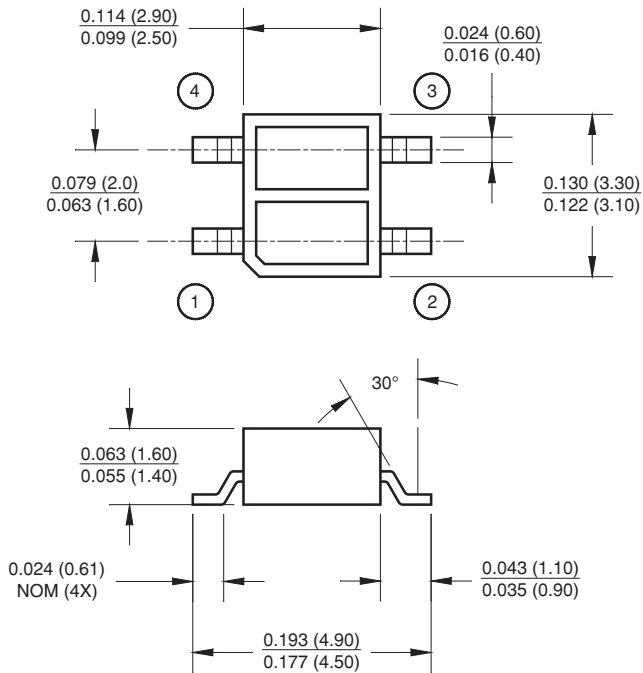

PIN 1 ANODE PIN 3 COLLECTOR
PIN 2 CATHODE PIN 4 EMITTER

NOTES:

1. Dimensions for all drawings are in inches (millimeters).
2. Tolerance of $\pm .010$ (.25) on all non-nominal dimensions

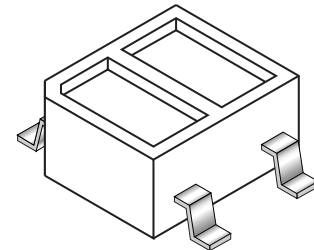

SCHEMATIC

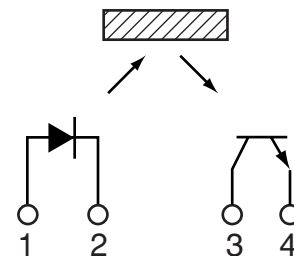

FEATURES

- Phototransistor output
- Tape and reel packaging
- No contact surface sensing
- Miniature package
- Lead form style: Gull Wing

ABSOLUTE MAXIMUM RATINGS ($T_A = 25^\circ\text{C}$ unless otherwise specified)

Parameter	Symbol	Rating	Units
Operating Temperature	T_{OPR}	-25 to +85	$^\circ\text{C}$
Storage Temperature	T_{STG}	-30 to +100	$^\circ\text{C}$
Soldering Temperature (Iron) ^(2,3,4)	T_{SOL-I}	240 for 5 sec	$^\circ\text{C}$
Soldering Temperature (Flow) ^(2,3)	T_{SOL-F}	260 for 10 sec	$^\circ\text{C}$
EMITTER			
Continuous Forward Current	I_F	50	mA
Reverse Voltage	V_R	5	V
Peak Forward Current ⁽⁵⁾	I_{FP}	1	mA
Power Dissipation ⁽¹⁾	P_D	75	mW
SENSOR			
Collector-Emitter Voltage	V_{CEO}	30	V
Emitter-Collector Voltage	V_{ECO}	5	V
Collector Current	I_C	20	mA
Power Dissipation ⁽¹⁾	P_D	50	mW

ELECTRICAL / OPTICAL CHARACTERISTICS ($T_A = 25^\circ\text{C}$ unless otherwise specified)

PARAMETER	TEST CONDITIONS	SYMBOL	MIN.	TYP.	MAX.	UNITS
INPUT DIODE						
Forward Voltage	$I_F = 20\text{ mA}$	V_F	—	1.2	1.6	V
Reverse Leakage Current	$V_R = 5\text{ V}$	I_R	—	—	10	μA
Peak Emission Wavelength	$I_F = 20\text{ mA}$	λ_{PE}	—	940	—	nm
OUTPUT TRANSISTOR						
Collector-Emitter Dark Current	$V_{CE} = 20\text{ V}, I_F = 0\text{ mA}$	I_D	—	—	100	nA
COUPLED						
On-State Collector Current	$I_F = 20\text{ mA}, V_{CE} = 5\text{ V}$	$I_{C(ON)}$	0.15	0.40	—	mA
Saturation Voltage		$V_{CE(SAT)}$	—	—	0.3	V
Rise Time	$V_{CC} = 5\text{ V}, I_{C(ON)} = 100\text{ }\mu\text{A}, R_L = 1\text{ K}\Omega$	t_r	—	20	—	μs
Fall Time		t_f	—	20	—	

NOTES:

1. Derate power dissipation linearly 1.33 mW/ $^\circ\text{C}$ above 25 $^\circ\text{C}$.
2. RMA flux is recommended.
3. Methanol or isopropyl alcohols are recommended as cleaning agents.
4. Soldering iron 1/16" (1.6mm) from housing.
5. Pulse conditions: $t_p = 100\text{ }\mu\text{s}; T = 10\text{ ms}$.

TYPICAL PERFORMANCE CURVES

Fig. 1 Normalized Collector Current vs. Distance between device and reflector

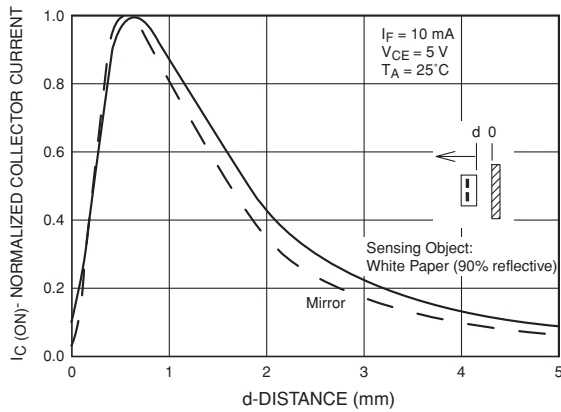

Fig. 2 Collector Current vs. Forward Current

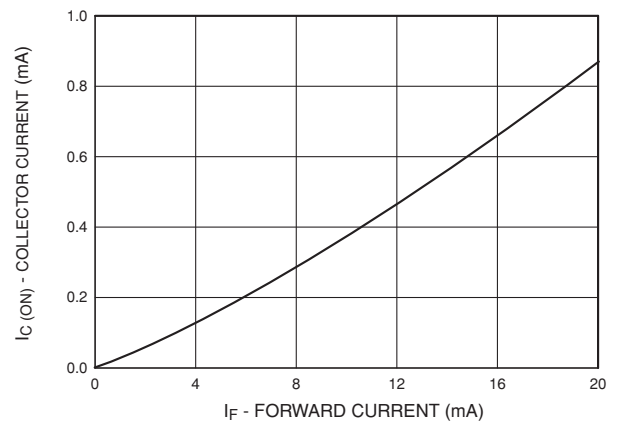

Fig. 3 Collector Current vs. Collector to Emitter Voltage

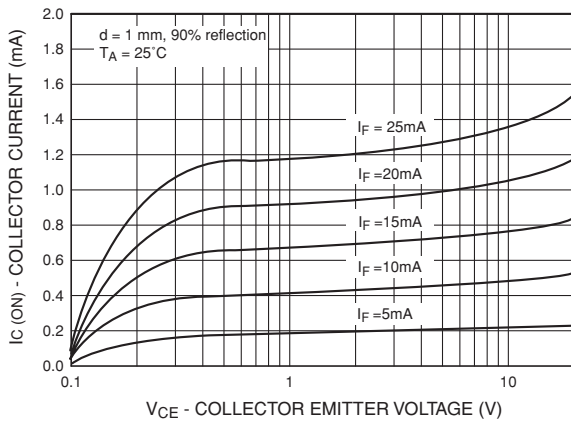

Fig. 4 Collector Emitter Dark Current (Normalized) vs. Ambient Temperature

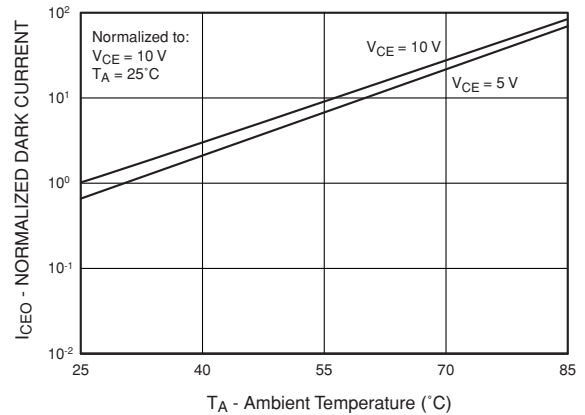

Fig. 5 Forward Current vs. Forward Voltage

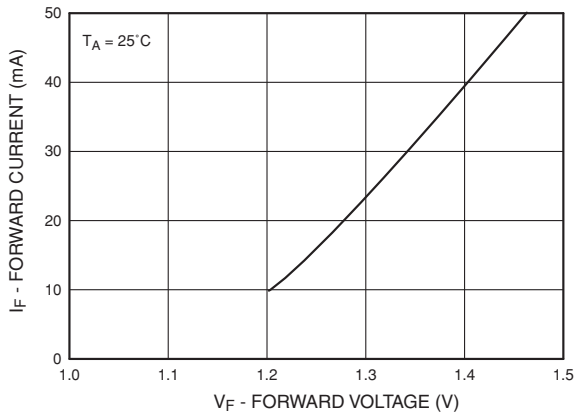

Fig. 6 Rise and Fall Time vs. Load Resistance

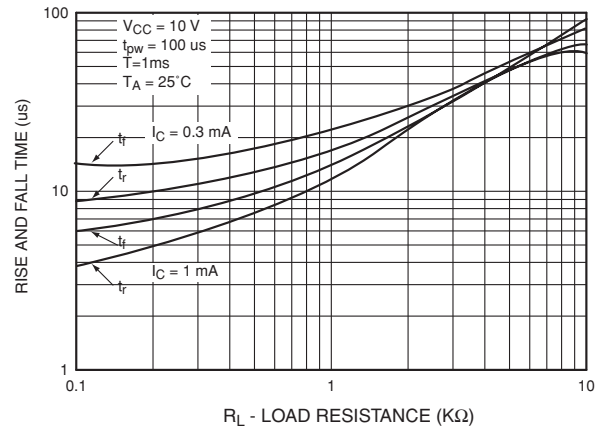
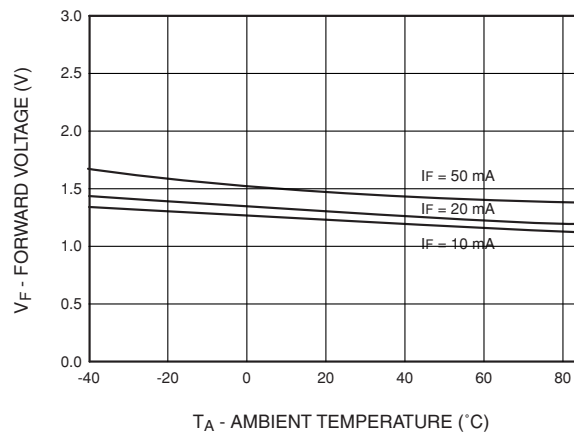

Fig. 7 Forward Voltage vs. Ambient Temperature



DISCLAIMER

FAIRCHILD SEMICONDUCTOR RESERVES THE RIGHT TO MAKE CHANGES WITHOUT FURTHER NOTICE TO ANY PRODUCTS HEREIN TO IMPROVE RELIABILITY, FUNCTION OR DESIGN. FAIRCHILD DOES NOT ASSUME ANY LIABILITY ARISING OUT OF THE APPLICATION OR USE OF ANY PRODUCT OR CIRCUIT DESCRIBED HEREIN; NEITHER DOES IT CONVEY ANY LICENSE UNDER ITS PATENT RIGHTS, NOR THE RIGHTS OF OTHERS.

LIFE SUPPORT POLICY

FAIRCHILD'S PRODUCTS ARE NOT AUTHORIZED FOR USE AS CRITICAL COMPONENTS IN LIFE SUPPORT DEVICES OR SYSTEMS WITHOUT THE EXPRESS WRITTEN APPROVAL OF THE PRESIDENT OF FAIRCHILD SEMICONDUCTOR CORPORATION. As used herein:

1. Life support devices or systems are devices or systems which, (a) are intended for surgical implant into the body, or (b) support or sustain life, and (c) whose failure to perform when properly used in accordance with instructions for use provided in the labeling, can be reasonably expected to result in a significant injury of the user.
2. A critical component in any component of a life support device or system whose failure to perform can be reasonably expected to cause the failure of the life support device or system, or to affect its safety or effectiveness.