

CDSUR400-HF

$I_o = 100\text{mA}$

$V_R = 80\text{ Volts}$

RoHS Device

Halogen Free

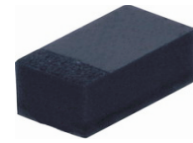

Features

- High Speed.
- Designed for mounting on small surface.
- Extremely thin/leadless package.
- Low leakage current.
- High mounting capability, strong surge withstand, high reliability.

Mechanical data

- Case: 0603/SOD-523F standard package, molded plastic.
- Terminals: Gold plated, Solderable per MIL-STD-750, method 2026.
- Polarity: Indicated by cathode band.
- Mounting position: Any.
- Weight: 0.003 grams(approx.).

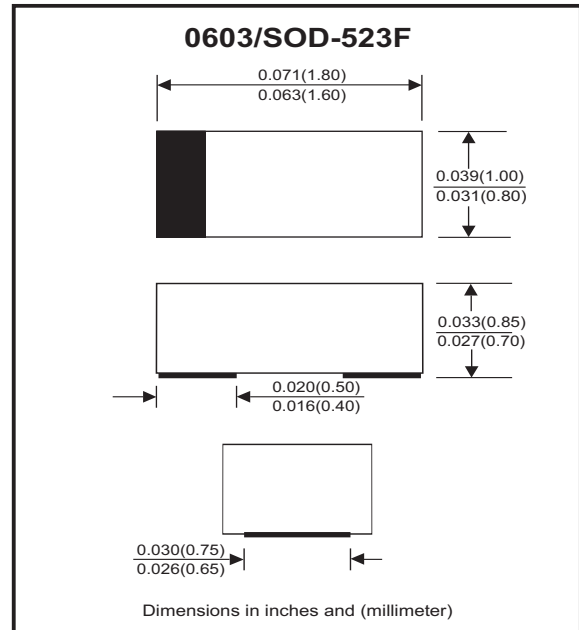

Circuit diagram



Maximum Rating (at $T_A=25\text{ }^\circ\text{C}$ unless otherwise noted)

Parameter	Conditions	Symbol	Min	Typ	Max	Unit
Repetitive peak reverse voltage		V_{RRM}			90	V
Reverse voltage		V_R			80	V
Average forward current		I_o			100	mA
Forward current, surge peak	8.3 ms single half sine-wave superimposed on rate load (JEDEC method)	I_{FSM}		1000		mA
Power dissipation		P_D			400	mW
Thermal resistance	Junction to ambient	$R_{\theta JA}$			250	$^\circ\text{C/W}$
Operating temperature range		T_j	-40		+125	$^\circ\text{C}$
Storage temperature range		T_{STG}	-55		+125	$^\circ\text{C}$

Electrical Characteristics (at $T_A=25\text{ }^\circ\text{C}$ unless otherwise noted)

Parameter	Conditions	Symbol	Min	Typ	Max	Unit
Forward voltage	$I_F = 100\text{ mA DC}$	V_F			1.0	V
Reverse current	$V_R = 80\text{V}$	I_R			0.1	μA
Capacitance between terminals	$f = 1\text{MHz}$, and 0.5V DC reverse voltage	C_T		3		pF
Reverse recovery time	$V_R = 6\text{V}$, $I_F = 10\text{mA}$, $R_L = 50\text{ ohms}$	T_{rr}		4		nS

RATING AND CHARACTERISTIC CURVES (CDSUR400-HF)

Fig.1 - Forward Characteristics

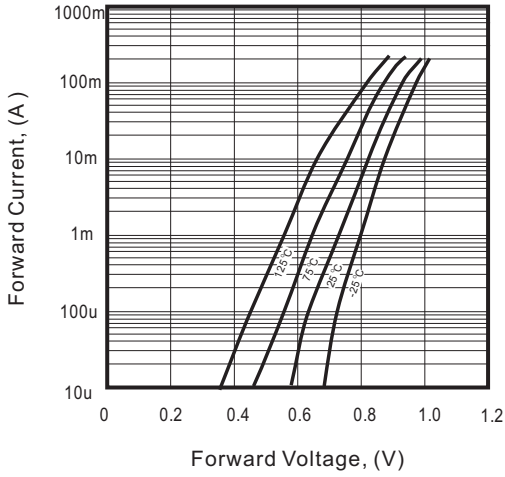

Fig.2 - Reverse Characteristics

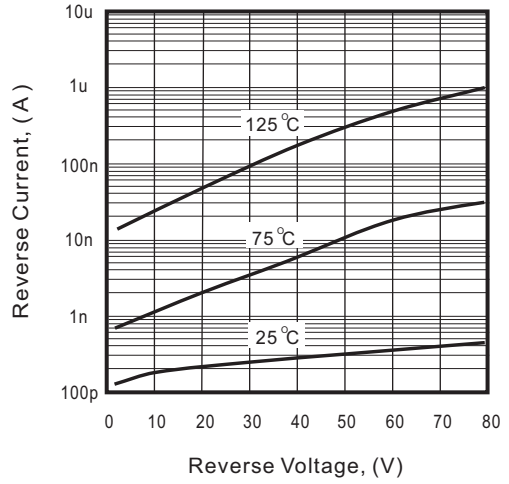

Fig.3 - Capacitance Between Terminals Characteristics

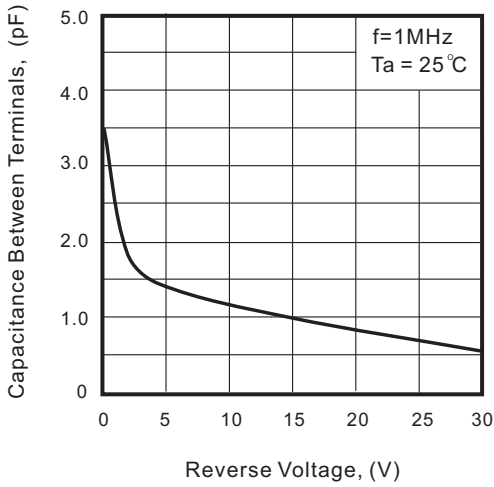
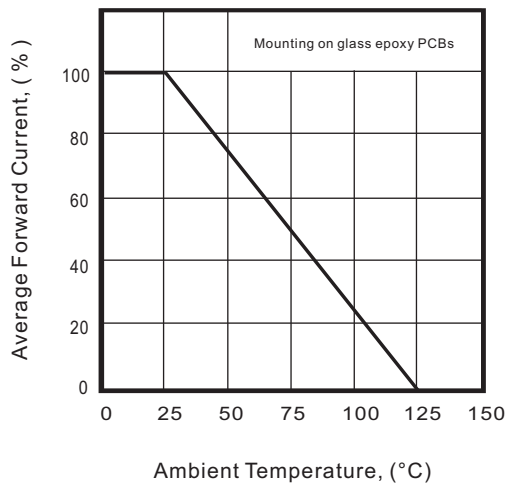
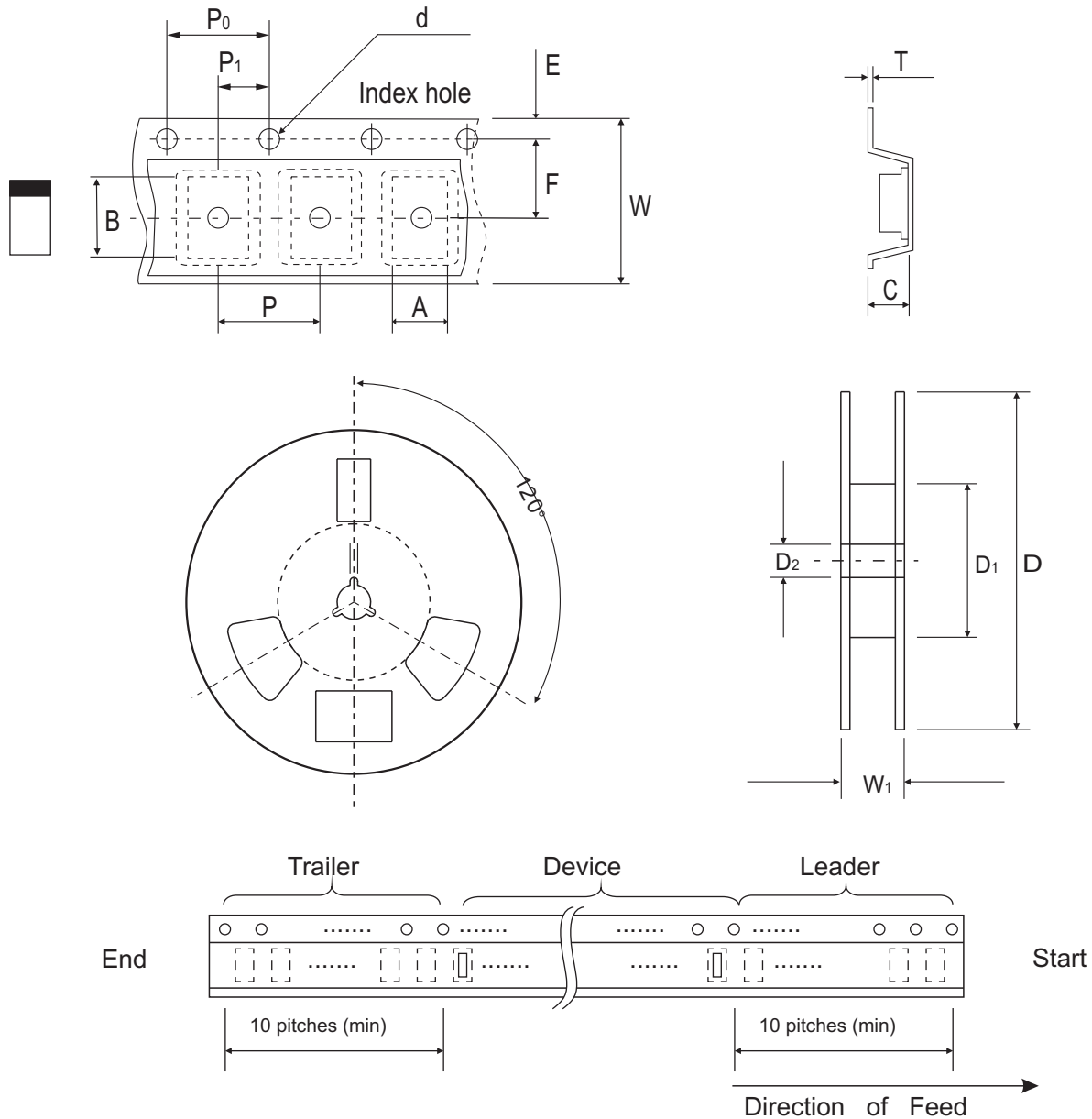

Fig.4 - Current Derating Curve



Reel Taping Specification



0603 (SOD-523)	SYMBOL	A	B	C	d	D	D ₁	D ₂
	(mm)	1.00 ± 0.10	1.85 ± 0.10	1.00 ± 0.10	1.55 ± 0.05	178 ± 1	60.0 MIN.	13.0 ± 0.20
	(inch)	0.039 ± 0.004	0.073 ± 0.004	0.039 ± 0.004	0.061 ± 0.002	7.008 ± 0.04	2.362 MIN.	0.512 ± 0.008

0603 (SOD-523)	SYMBOL	E	F	P	P ₀	P ₁	T	W	W ₁
	(mm)	1.75 ± 0.10	3.50 ± 0.05	4.00 ± 0.10	4.00 ± 0.10	2.00 ± 0.05	0.23 ± 0.05	8.00 ± 0.20	13.5 MAX.
	(inch)	0.069 ± 0.004	0.138 ± 0.002	0.157 ± 0.004	0.157 ± 0.004	0.079 ± 0.004	0.009 ± 0.002	0.315 ± 0.008	0.531 MAX.

Marking Code

Part Number	Marking Code
CDSUR400-HF	S1



Suggested PAD Layout

SIZE	0603/SOD-523F	
	(mm)	(inch)
A	1.25	0.049
B	0.60	0.024
C	1.00	0.039
D	1.85	0.073
E	0.65	0.026

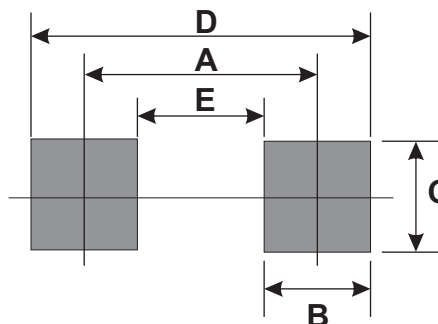

Standard Packaging

Case Type	Qty Per Reel	Reel Size
	(Pcs)	(inch)
0603/SOD-523F	4,000	7