

LOW POWER AND LOW OFFSET VOLTAGE SUPER SMALL-SIZED SINGLE C-MOS COMPARATOR

■GENERAL DESCRIPTION

The **NJU7108** is a super small-sized package single C-MOS comparator with push pull output.

The operating voltage is from 1V to 5.5V, and the interface can be connected with most of TTL and C-MOS type standard logic ICs.

Furthermore, The input offset voltage is lower than 4mV and Low operating current 10 μ A, therefore they can be suitable for battery use items and other portable items.

The available package is not only SC88A, but also ultra small package TSON6.

■PACKAGE INFORMATION



**NJU7108F3
(SC88A)**



**NJU7108KL1
(TSON6)**

■FEATURES

- Single Low Power Supply $V_{DD}=1.0\sim 5.5V$
- Low Offset Voltage $V_{IO}=4mV$ max
- Low Operating Current $I_{DD}=10\mu A$ typ
- Push Pull Output
- Package Outline SC88A, TSON6
- C-MOS Technology

■PIN CONFIGURATION

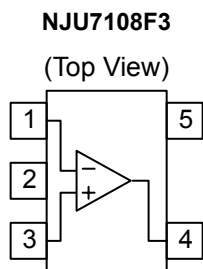

- NJU7108F3
PIN CONFIGURATION**
1. -INPUT
 2. V_{SS}
 3. +INPUT
 4. OUTPUT
 5. V_{DD}

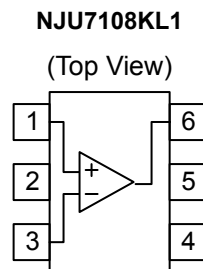

- NJU7108KL1
PIN CONFIGURATION**
1. +INPUT
 2. V_{SS}
 3. -INPUT
 4. V_{DD}
 5. V_{SS}
 6. OUTPUT

(CAUTION) There is not pin-compatible with NJU7108F3 and NJU7108KL1.

■EQUIVALENT CIRCUIT

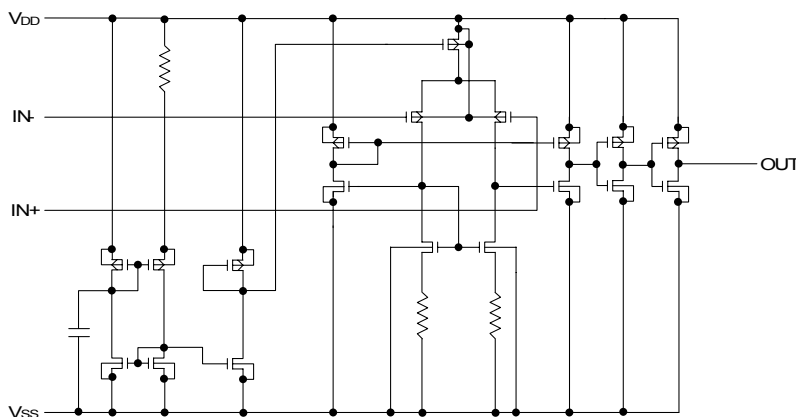

■ABSOLUTE MAXIMUM RATINGS

(Ta=25°C)

PARAMETER	SYMBOL	RATING	UNIT
Supply Voltage	V_{DD}	7.0	V
Differential Input Voltage	V_{ID}	± 7.0	V
Common Mode Input Voltage	V_{IC}	-0.3~7.0 (Note1)	V
Power Dissipation	P_D	SC88A : 250 (Note2) TSON6 : 515 (Note3)	mW
Operating Temperature	T_{opr}	-40~+85	°C
Storage Temperature	T_{stg}	-55~+125	°C

(Note1) For supply voltage less than +7.0V, the absolute maximum input voltage is equal to supply voltage.

(Note2) Mounted on aglass epoxy board (FR-4) in size of 50x50x1.6mm.

(Note3) Mounted on Two layer board(40x40x1.6mm, single layer, both-side 50% share of the wiring substrate).

(Note4) Decoupling capacitor should be connected between V_{DD} and V_{SS} due to the stabilized operation for the circuit.

■ELECTRICAL CHARACTERISTICS

($V_{DD}=3.0V, R_L=\infty, Ta=25^\circ C$)

PARAMETER	SYMBOL	CONDITIONS	MIN	TYP	MAX	UNIT
Operating Voltage	V_{DD}		1.0	-	5.5	V
Input Offset Voltage	V_{IO}	$V_{IN}=V_{DD}/2$	-	-	4	mV
Input Offset Current	I_{IO}		-	1	-	pA
Input Bias Current	I_{IB}		-	1	-	pA
Input Common Mode Voltage Range	V_{ICM}		0~2.5	-	-	V
High Level Output Voltage	V_{OH}	$I_{OH}=-5mA$	2.7	-	-	V
Low Level Output Voltage	V_{OL}	$I_{OL}=+5mA$	-	-	0.3	V
Supply Current	I_{DD}		-	10	20	uA

($V_{DD}=3.0V, f=19kHz, C_L=15pF, Ta=25^\circ C$)

PARAMETER	SYMBOL	CONDITIONS	MIN	TYP	MAX	UNIT
Propagation Delay Low to High	t_{PLH}	Over Drive=100mV	-	500	-	ns
Propagation Delay High to Low	t_{PHL}	Over Drive=100mV	-	190	-	ns
Output Signal Rising Time	t_{TLH}	Over Drive=100mV	-	10	-	ns
Output Signal Falling Time	t_{THL}	Over Drive=100mV	-	5	-	ns

■TIMING WAVEFORM

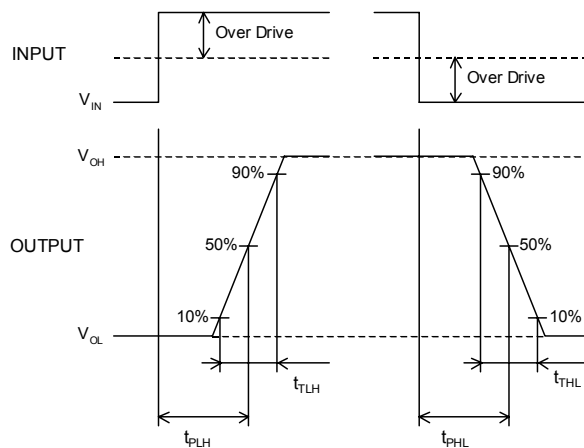

■ TYPICAL CHARACTERISTICS

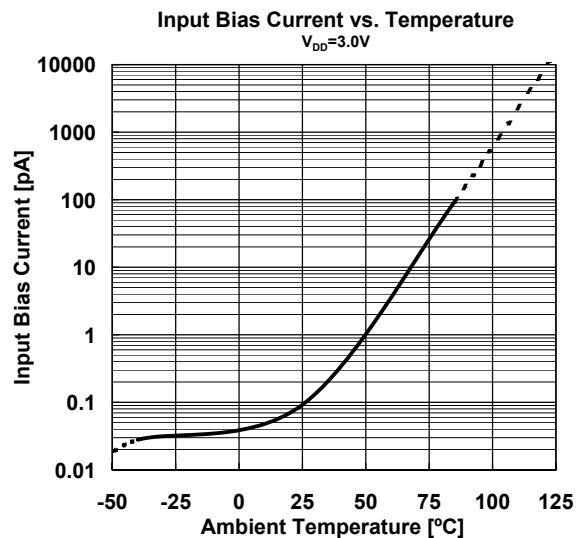
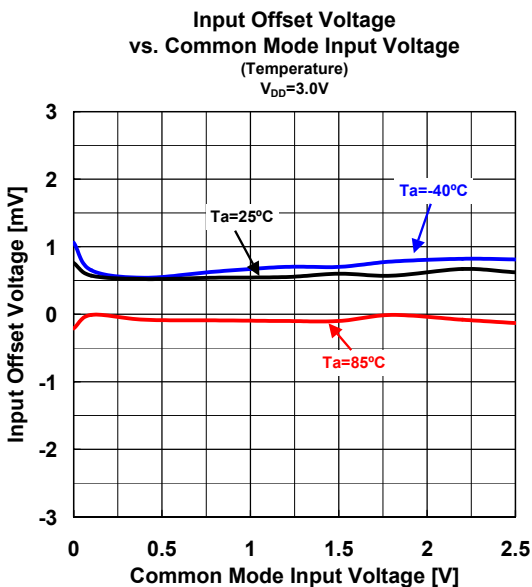
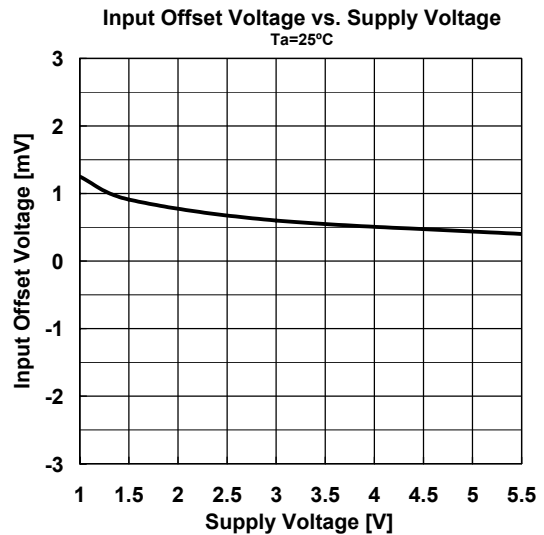
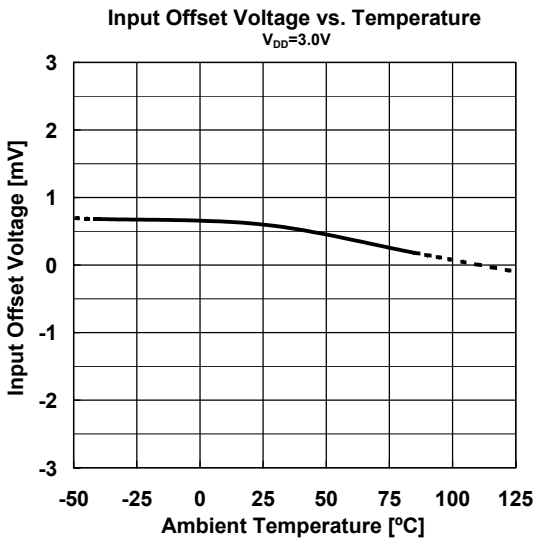
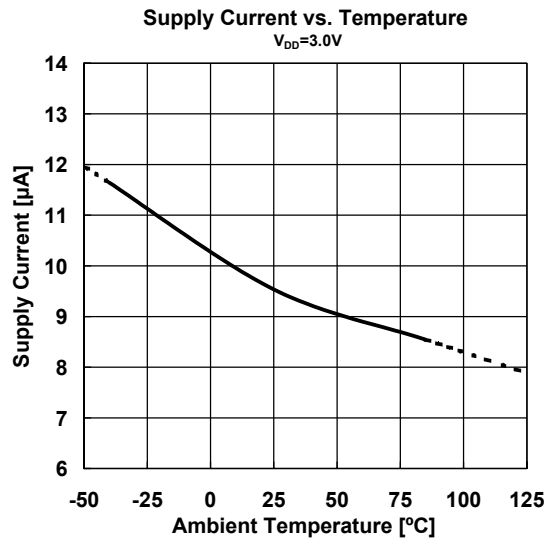
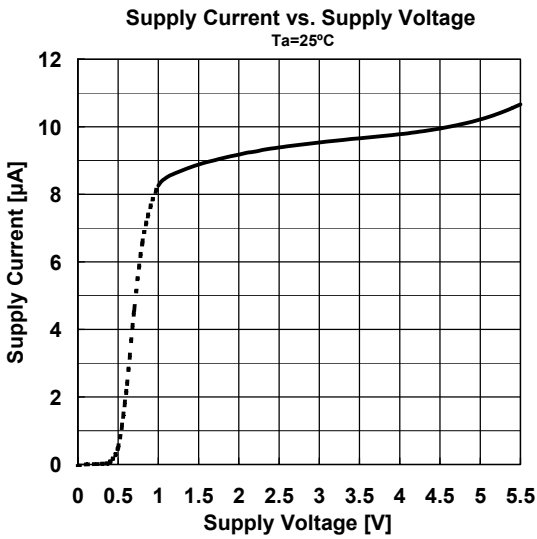

■ TYPICAL CHARACTERISTICS

High Level Output Voltage vs. Output Current
(Temperature)
 $V_{DD}=1.0V$

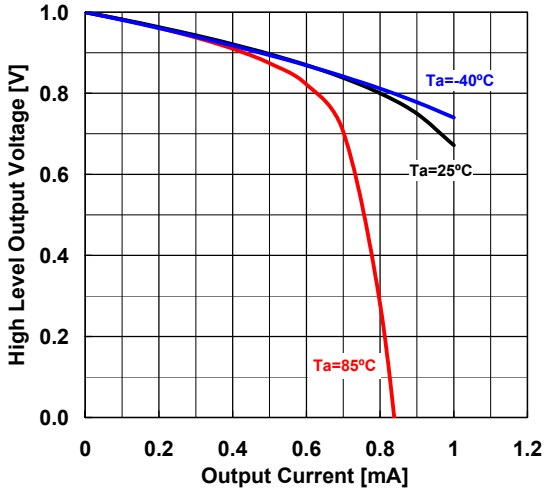

Low Level Output Voltage vs. Output Current
(Temperature)
 $V_{DD}=1.0V$

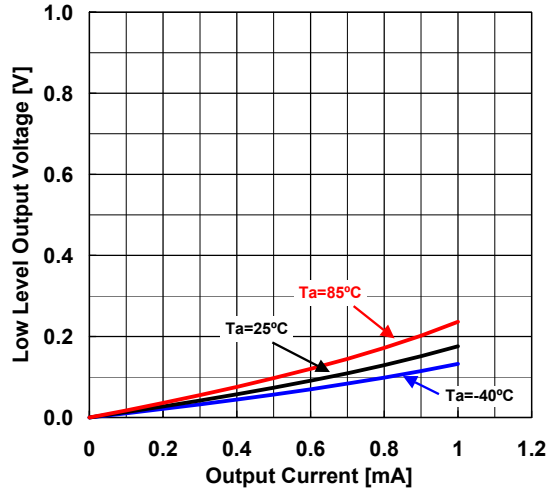

High Level Output Voltage vs. Output Current
(Temperature)
 $V_{DD}=3.0V$

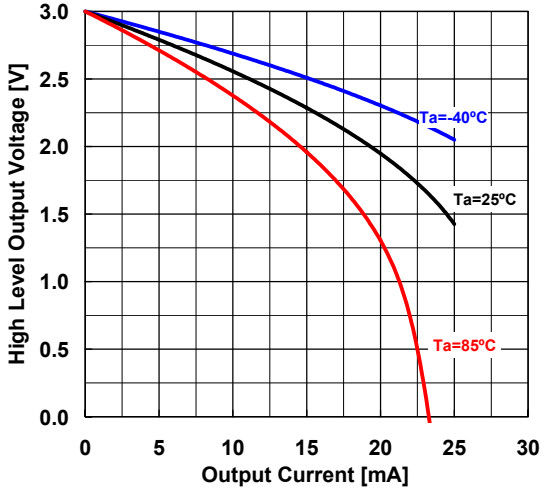

Low Level Output Voltage vs. Output Current
(Temperature)
 $V_{DD}=3.0V$

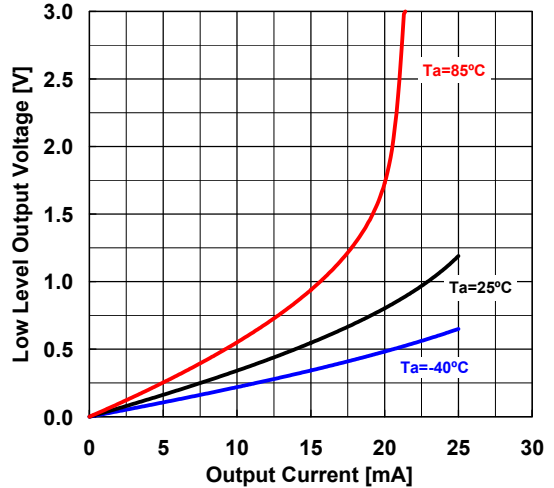

High Level Output Voltage vs. Output Current
(Temperature)
 $V_{DD}=5.5V$

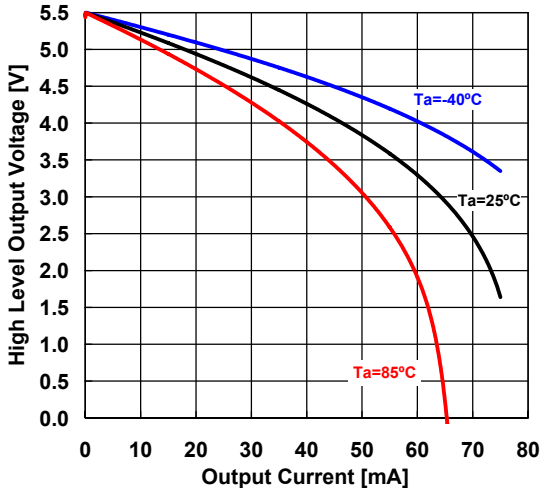

Low Level Output Voltage vs. Output Current
(Temperature)
 $V_{DD}=5.5V$

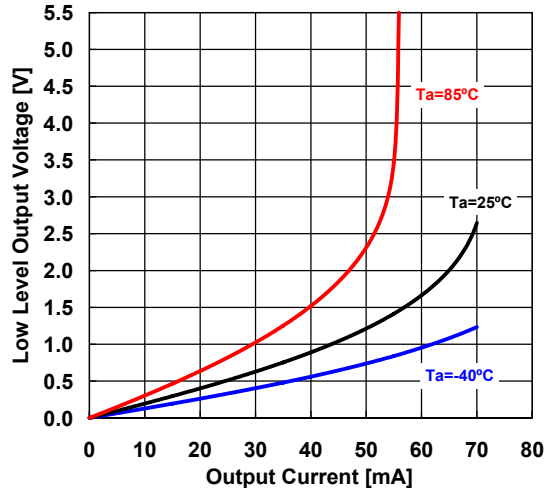

■ TYPICAL CHARACTERISTICS

Propagation Delay t_{PLH}

$V_{DD}/V_{SS} = \pm 1.5V$, Over Drive=100mV, $C_L = 15pF$, $T_a = 25^\circ C$

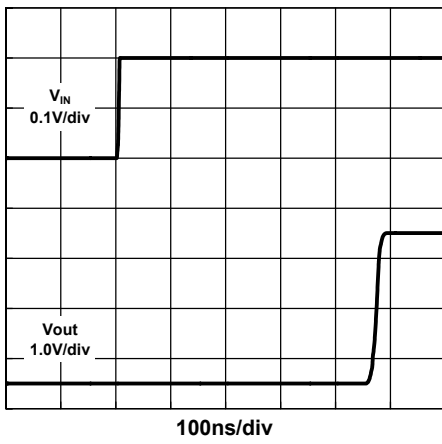

Propagation Delay t_{PHL}

$V_{DD}/V_{SS} = \pm 1.5V$, Over Drive=100mV, $C_L = 15pF$, $T_a = 25^\circ C$

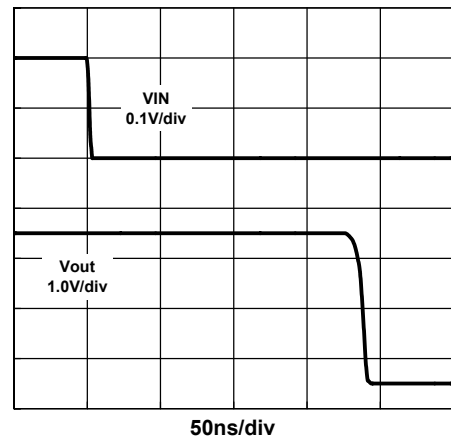

Propagation Delay vs. Temperature

$V_{DD}/V_{SS} = \pm 1.5V$, $V_{IN} = 200mV_{pp}$, Over Drive=100mV, $C_L = 15pF$

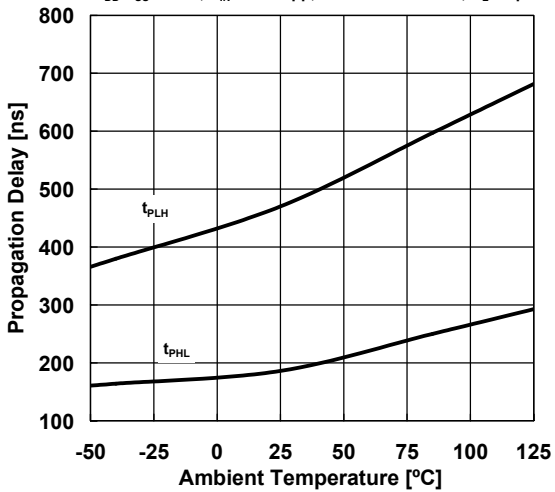

Propagation Delay vs. Supply Voltage

$V_{IN} = 200mV_{pp}$, Over Drive=100mV, $C_L = 15pF$, $T_a = 25^\circ C$

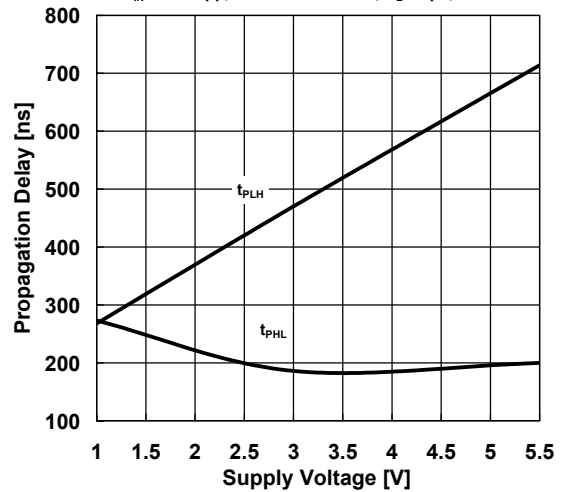

■ TEST CIRCUIT

Switching Characteristics Measurement Circuit

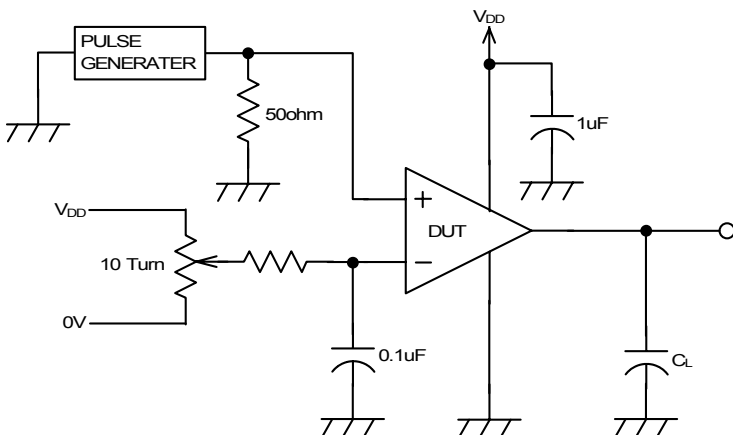

■PACKAGE DIMENSIONS

SC88A

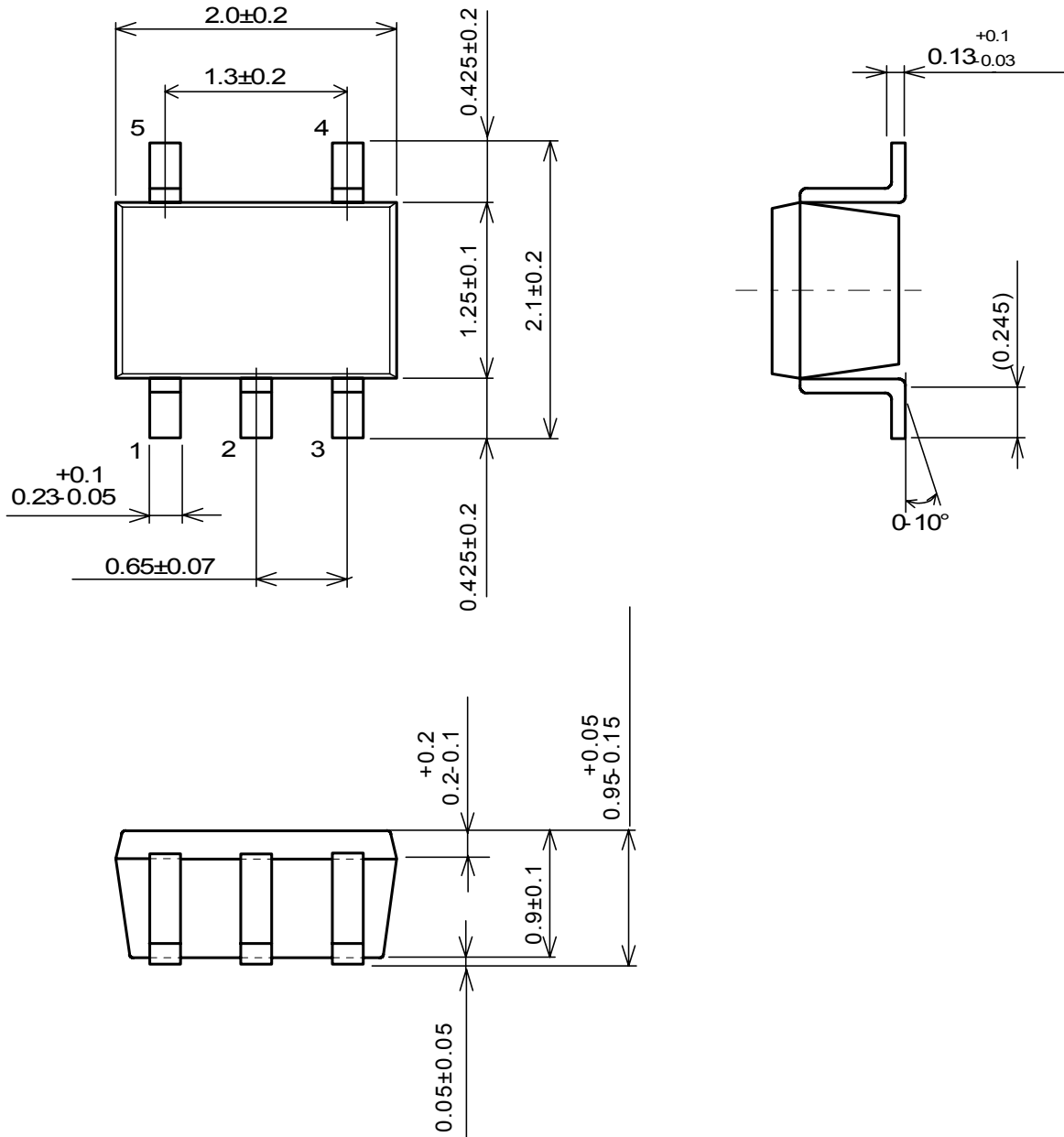

■PACKAGE DIMENSIONS

TS0N6

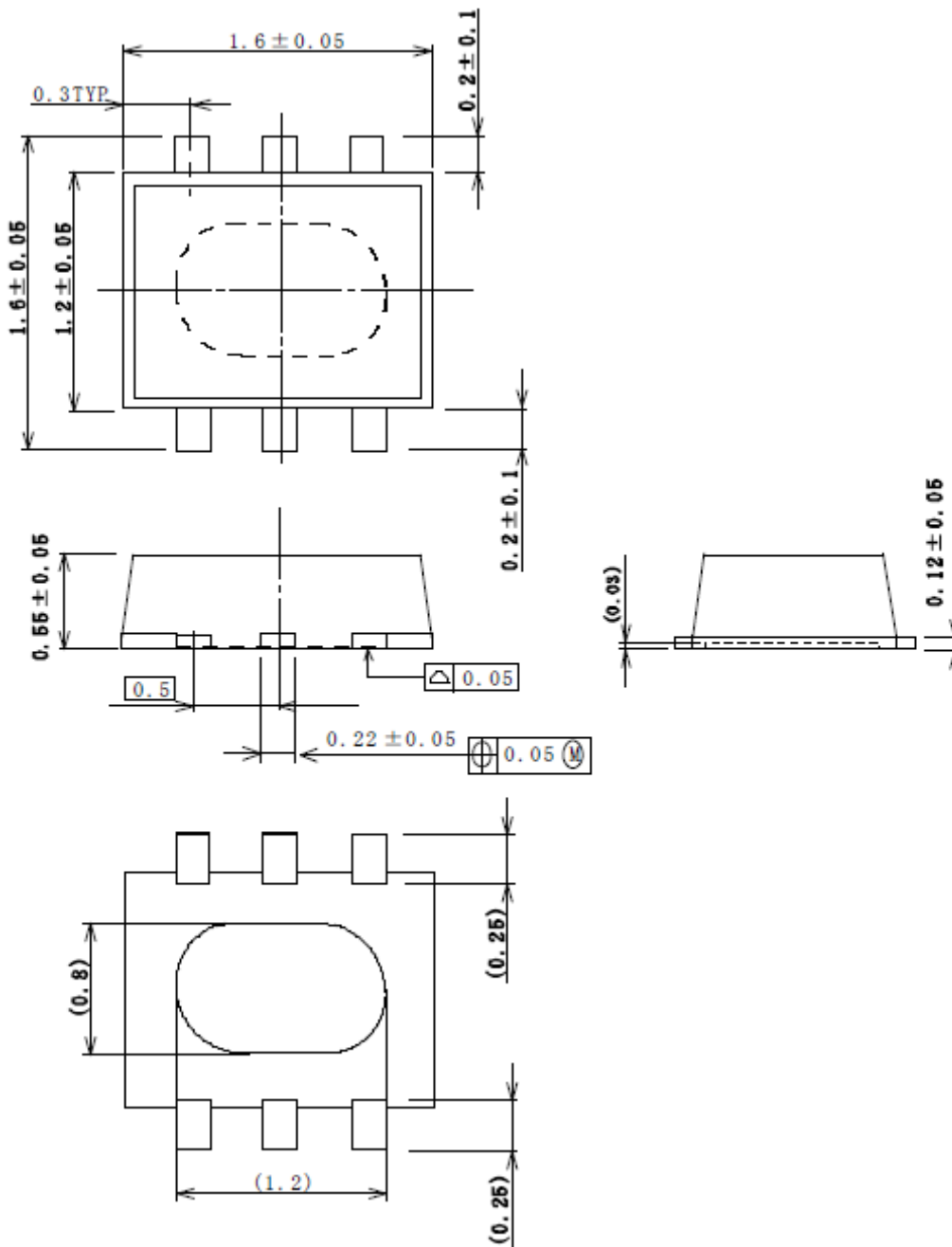

[CAUTION]
 The specifications on this data book are only given for information, without any guarantee as regards either mistakes or omissions. The application circuits in this data book are described only to show representative usages of the product and not intended for the guarantee or permission of any right including the industrial rights.

Mouser Electronics

Authorized Distributor

Click to View Pricing, Inventory, Delivery & Lifecycle Information:

[NJR:](#)

[NJU7108F3-TE2](#) [NJU7108F3-TE1](#)