



BGU7258

5 GHz ISM SiGe:C low-noise amplifier MMIC with bypass

Rev. 3 — 29 August 2018

Product data sheet

1 Product profile

1.1 General description

The BGU7258 is a fully integrated MMIC Low Noise Amplifier (LNA) for wireless receiver applications in the 5 GHz to 6 GHz ISM band. Manufactured in NXP's high performance SiGe:C technology, the BGU7258 couples best-in-class gain, noise figure, linearity and efficiency with the process stability and ruggedness that are the hallmarks of SiGe technology. The BGU7258 features a robust temperature-compensated internal bias network and an integral bypass / shutdown feature that stabilizes the DC operating point over temperature and enables operation in the presence of high input signals, while minimizing current consumption in bypass (standby) mode. The 1.6 mm x 1.6 mm footprint coupled with only two external components, makes the circuit board implementation of the BGU7258 LNA the smallest IEEE 802.11ac LNA with bypass solution on the market, ideal for space sensitive applications.

1.2 Features and benefits

- Fully integrated, high performance LNA with built-in bypass
- Integrated DC blocking at RF input and RF output, with only two external components needed.
- Low 1.6 dB noise figure with 13 mA current consumption
- Low bypass current of 1 μ A (typical)
- Single supply 3.0 V to 3.6 V operation
- Integrated concurrent 2.4 GHz notch filter and temperature stabilized bias network
- High IP_{3i} and low EVM
- High ESD protection of 2 kV (HBM) on all pins
- Small, 0.5 mm pitch, 1.6 x 1.6 x 0.5 mm QFN-style package, MSL 1 at 260 °C
- Compliant to Directive 2002/95/EC, regarding Restriction of Hazardous Substances (RoHS) following NXP's RHF-2006 indicator D (dark green)

1.3 Applications

- IEEE 802.11a/n/ac WiFi, WLAN
- Smartphones, tablets, net-books, and other portable computing devices
- Access points, routers, gateways
- Wireless video
- LTE advanced in unlicensed spectrum (LTE-U)
- General-purpose ISM applications



1.4 Quick reference data

Table 1. Quick reference data

$T_{amb} = 25\text{ }^{\circ}\text{C}$; $V_{CC} = 3.3\text{ V}$; $Z_S = Z_L = 50\text{ }\Omega$; $P_i = -30\text{ dBm}$; $f = 5.5\text{ GHz}$ unless otherwise specified. All measurements done on application board (with a DC-decoupling capacitor of 4.7 nF placed close to V_{CC} [pin 6] and a 0.3 pF matching shunt capacitor at RF_IN) with SMA connectors as reference plane.

Symbol	Parameter	Conditions	Min	Typ	Max	Unit	
I _{CC}	supply current	gain mode	-	13	-	mA	
		bypass mode	-	1	-	μA	
G _p	power gain	gain mode					
		f = 5.1 GHz [1]	12	14	16	dB	
		f = 5.9 GHz [1]	11	13	15	dB	
		bypass mode					
		f = 5.1 GHz [1]	-	-7	-	dB	
		f = 5.9 GHz [1]	-	-7	-	dB	
P _{i(1dB)}	input power at 1 dB gain compression	gain mode	-	-4	-	dBm	
NF	noise figure	gain mode [1]	-	1.6	-	dB	

[1] Printed-Circuit Board (PCB) and connector losses excluded.

2 Pinning information

Table 2. Pinning

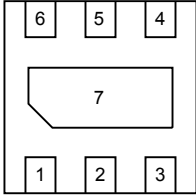
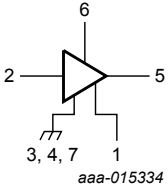
Pin	Symbol	Description	Simplified outline	Graphic symbol
1	CTRL	gain control, switch between gain and bypass mode	 <p>Transparent top view</p>	 <p>aaa-015334</p>
2	RF_IN	RF in		
3	GND	ground		
4	GND	ground		
5	RF_OUT	RF out		
6	V _{CC}	supply voltage		
7	GND	ground pad		

3 Ordering information

Table 3. Ordering information

Type number	Package		Version
	Name	Description	
BGU7258	HXSON6	plastic thermal enhanced extremely thin small outline package; no leads; 6 terminals; body 1.6 x 1.6 x 0.5 mm	SOT1189-1
OM7870	-	5 GHz WLAN evaluation board	-

4 Marking

Table 4. Marking code

Type number	Marking
BGU7258	258

5 Block diagram

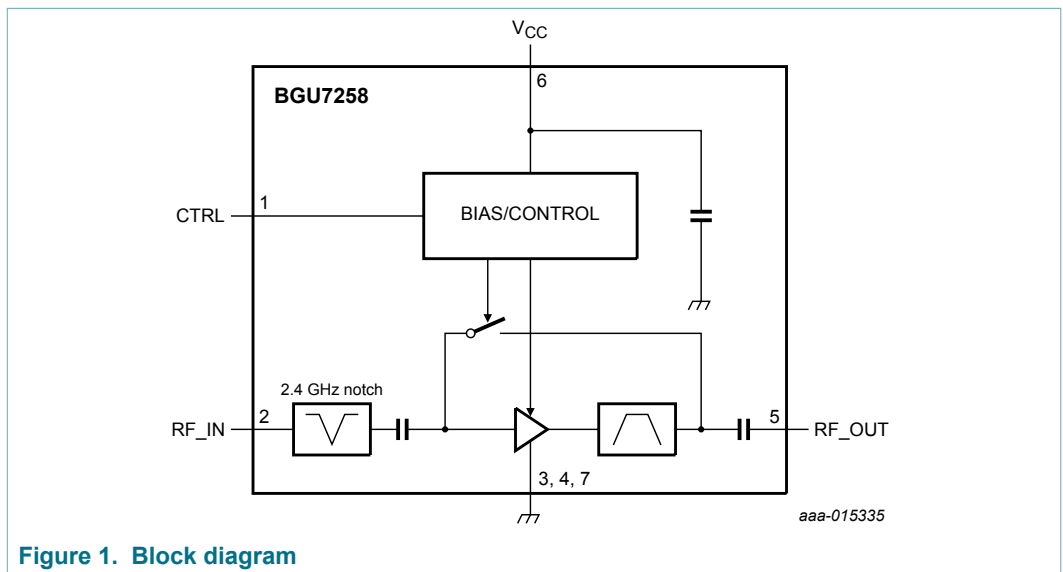

6 Limiting values

Table 5. Limiting values

In accordance with the Absolute Maximum Rating System (IEC 60134). Absolute Maximum Ratings are given as limiting values of stress conditions during operation, that must not be exceeded under the worst case conditions.

Symbol	Parameter	Conditions		Min	Max	Unit
V_{CC}	supply voltage	RF input AC coupled	[1]	-0.5	+5.0	V
$V_{I(RF_IN)}$	input voltage on pin RF_IN	DC	[1][2][3]	-0.5	+5.0	V
$V_{I(RF_OUT)}$	input voltage on pin RF_OUT	DC	[1][2][3]	-0.5	+5.0	V
$V_{I(CTRL)}$	input voltage on pin CTRL		[1][2]	-0.5	+5.0	V
T_{stg}	storage temperature			-40	+150	°C
T_j	junction temperature			-	150	°C
V_{ESD}	electrostatic discharge voltage	Human Body Model (HBM); according to the joint JEDEC/ESDA standard JS-001-2012		-	±2	kV
		Charged Device Model (CDM); according to JEDEC standard JESD22-C101		-	±1	kV
P_i	input power	f = 5500 MHz; CW				
		gain mode; $V_{CC} = 3.3$ V	[1]	-	10	dBm
		bypass mode; $V_{CC} = 3.3$ V	[1]	-	10	dBm

[1] Stressed with pulses of 200 ms in duration in an application circuit as depicted in [Figure 34](#).

[2] Warning: due to internal ESD diode protection, the applied DC voltage should not exceed $V_{CC} + 0.6$ V and should not exceed 5.0 V in order to avoid excess current.

[3] The RF input and RF output are AC-coupled through an internal DC blocking capacitor.

7 Thermal characteristics

Table 6. Thermal characteristics

Symbol	Parameter	Conditions	Typ	Unit
$R_{th(j-case)}$	thermal resistance from junction to case		250	K/W

8 Static characteristics

Table 7. Static characteristics

Symbol	Parameter	Conditions	Min	Typ	Max	Unit
V_{CC}	supply voltage	RF input, AC coupled	3.0	3.3	3.6	V
I_{CC}	supply current	$P_i = -30$ dBm				
		gain mode	-	13	-	mA
		bypass mode	-	1	-	μ A
$I_{I(CTRL)}$	input current on pin CTRL	gain mode	-	50	-	μ A
T_{amb}	ambient temperature		-40	+25	+85	$^{\circ}$ C

9 Dynamic characteristics

Table 8. Dynamic characteristics

$T_{amb} = 25$ $^{\circ}$ C; $V_{CC} = 3.3$ V; $Z_S = Z_L = 50$ Ω ; $P_i = -30$ dBm; $f = 5.5$ GHz unless otherwise specified. All measurements done on application board (with a DC-decoupling capacitor of 4.7 nF placed close to V_{CC} [pin 6] and a 0.3 pF matching shunt capacitor at RF_IN) with SMA connectors as reference plane.

Symbol	Parameter	Conditions	Min	Typ	Max	Unit	
f	frequency		[1] 4900	-	5925	MHz	
G_p	power gain	gain mode	[2]				
		f = 5.1 GHz		12	14	16	dB
		f = 5.9 GHz		11	13	15	dB
		bypass mode	[2]				
		f = 5.1 GHz		-	-7	-	dB
		f = 5.9 GHz		-	-7	dB	
RL_{in}	input return loss	gain mode		-	17	-	dB
		bypass mode		-	10	-	dB
RL_{out}	output return loss	gain mode		-	18	-	dB
		bypass mode		-	16	-	dB
ISL	isolation	gain mode		-	20	-	dB
G_{flat}	gain flatness	bandwidth across 80 MHz channel					
		gain mode		-	± 0.2	-	dB
		bypass mode		-	± 0.2	-	dB
$P_{1(1dB)}$	input power at 1 dB gain compression	gain mode		-	-4	-	dBm
$IP3_i$	input third-order intercept point	two-tone; 5 MHz spacing					
		$P_i = -20$ dBm; gain mode		-	8	-	dBm
		$P_i = -5$ dBm; bypass mode		-	27	-	dBm
NF	noise figure	gain mode	[2]	-	1.6	-	dB
$t_{sw(G)}$	gain switch time	$V_{I(CTRL)} = 0$ V to 3.3 V					
		gain mode	[3]	-	150	-	ns

Symbol	Parameter	Conditions	Min	Typ	Max	Unit
		bypass mode	[4] -	20	-	ns
K	Rollett stability factor	0 GHz ≤ f ≤ 20 GHz; gain mode	-	> 1	-	

- [1] ISM 5 GHz (in band).
- [2] Printed-Circuit Board (PCB) and connector losses excluded.
- [3] measured from 50 % of $V_{I(CTRL)}$ control signal to 90 % of maximum RF output signal.
- [4] measured from 50 % of $V_{I(CTRL)}$ control signal to 10 % of maximum RF output signal.

10 Gain control

Table 9. Gain control (pin CTRL)

$T_{amb} = 25\text{ °C}$; $V_{CC} = 3.3\text{ V}$.

$V_{I(CTRL)}$ (V)	Mode
≤ 0.5	bypass
≤ 2.5	gain

11 Application information

Please contact your local sales representative for more information. Application note AN11453 is available on the NXP website.

11.1 Graphs

Typical performance measured on the application board.

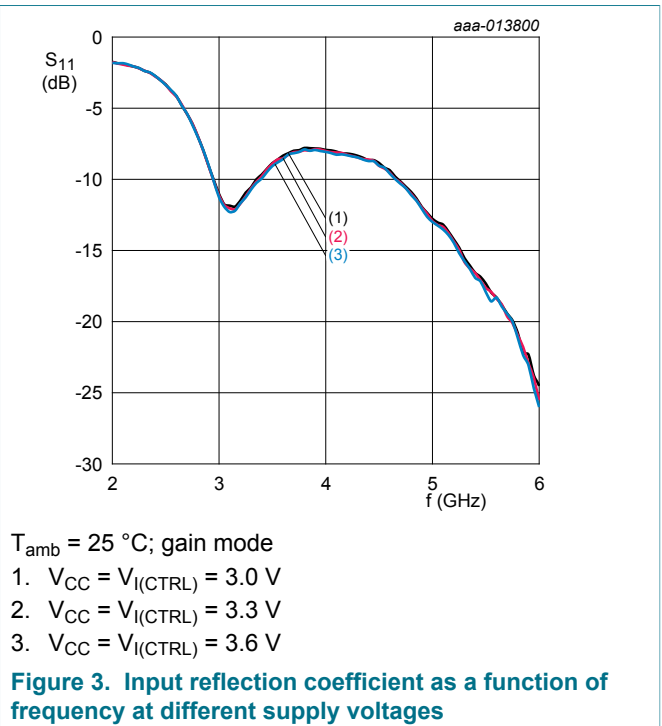
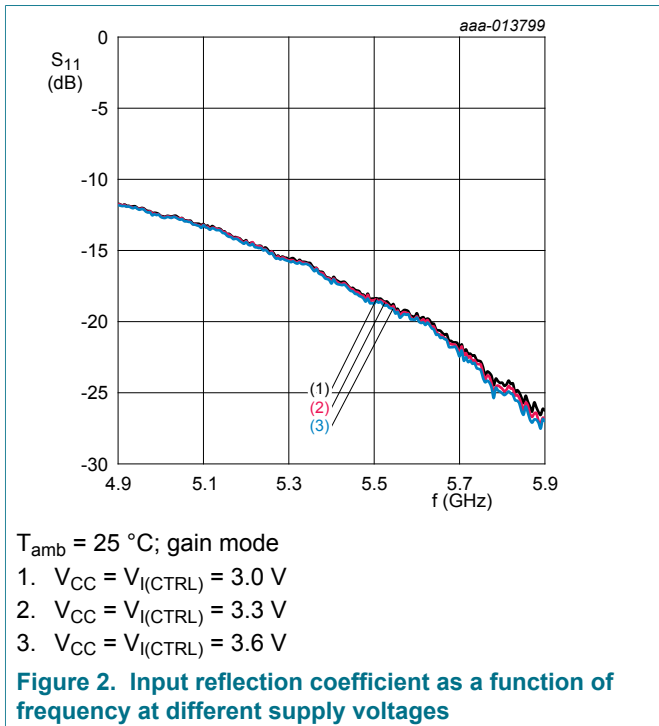

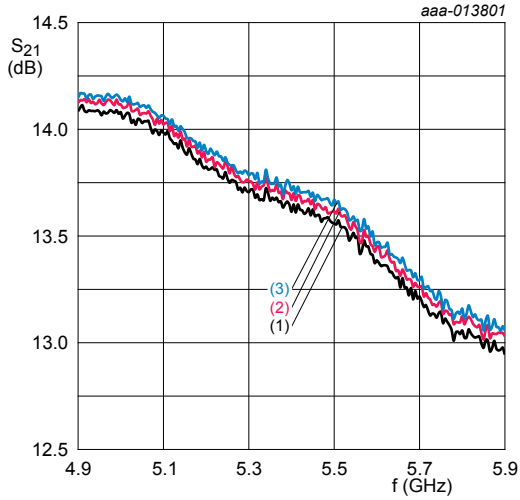

$T_{amb} = 25\text{ }^{\circ}\text{C}$; gain mode
 1. $V_{CC} = V_{I(CTRL)} = 3.0\text{ V}$
 2. $V_{CC} = V_{I(CTRL)} = 3.3\text{ V}$
 3. $V_{CC} = V_{I(CTRL)} = 3.6\text{ V}$

Figure 4. Forward transmission coefficient as a function of frequency at different supply voltages

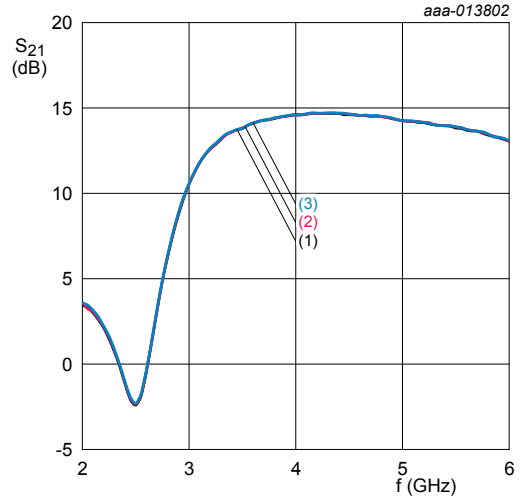

$T_{amb} = 25\text{ }^{\circ}\text{C}$; gain mode
 1. $V_{CC} = V_{I(CTRL)} = 3.0\text{ V}$
 2. $V_{CC} = V_{I(CTRL)} = 3.3\text{ V}$
 3. $V_{CC} = V_{I(CTRL)} = 3.6\text{ V}$

Figure 5. Forward transmission coefficient as a function of frequency at different supply voltages

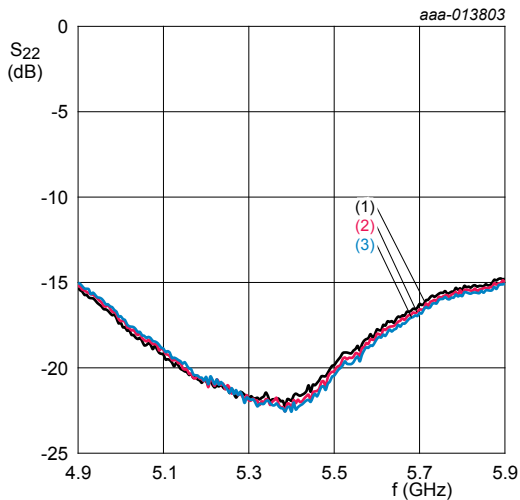

$T_{amb} = 25\text{ }^{\circ}\text{C}$; gain mode
 1. $V_{CC} = V_{I(CTRL)} = 3.0\text{ V}$
 2. $V_{CC} = V_{I(CTRL)} = 3.3\text{ V}$
 3. $V_{CC} = V_{I(CTRL)} = 3.6\text{ V}$

Figure 6. Output reflection coefficient as a function of frequency at different supply voltages

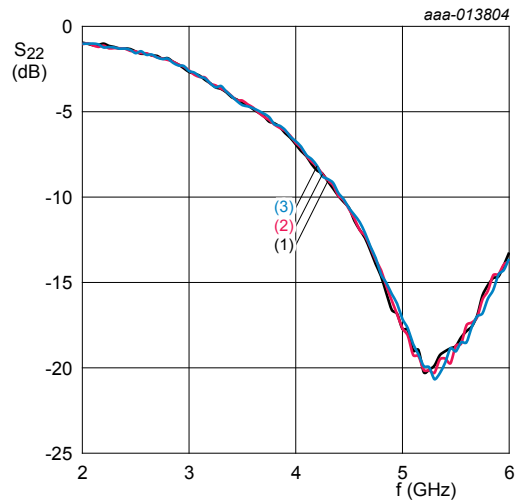

$T_{amb} = 25\text{ }^{\circ}\text{C}$; gain mode
 1. $V_{CC} = V_{I(CTRL)} = 3.0\text{ V}$
 2. $V_{CC} = V_{I(CTRL)} = 3.3\text{ V}$
 3. $V_{CC} = V_{I(CTRL)} = 3.6\text{ V}$

Figure 7. Output reflection coefficient as a function of frequency at different supply voltages

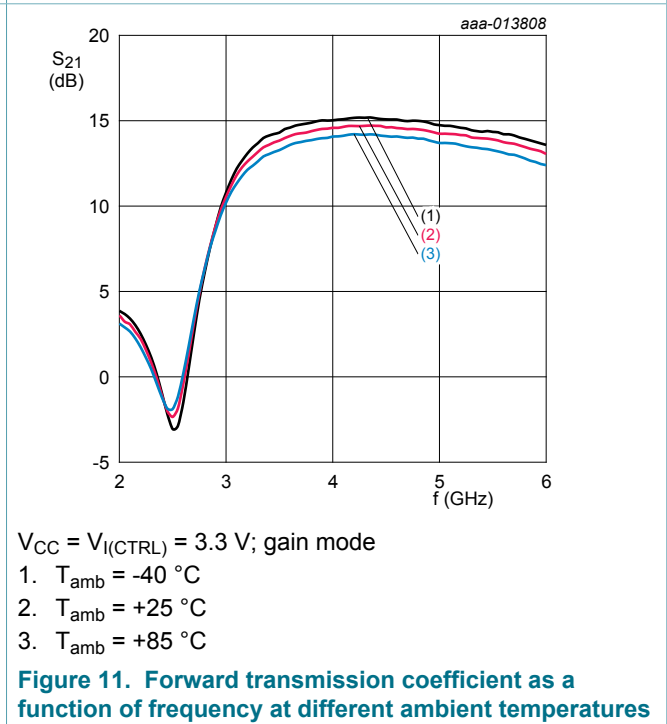
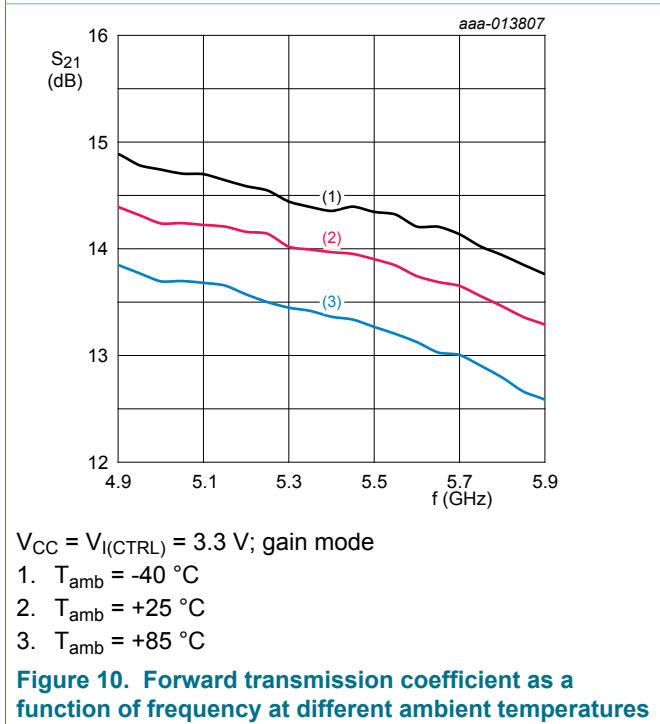
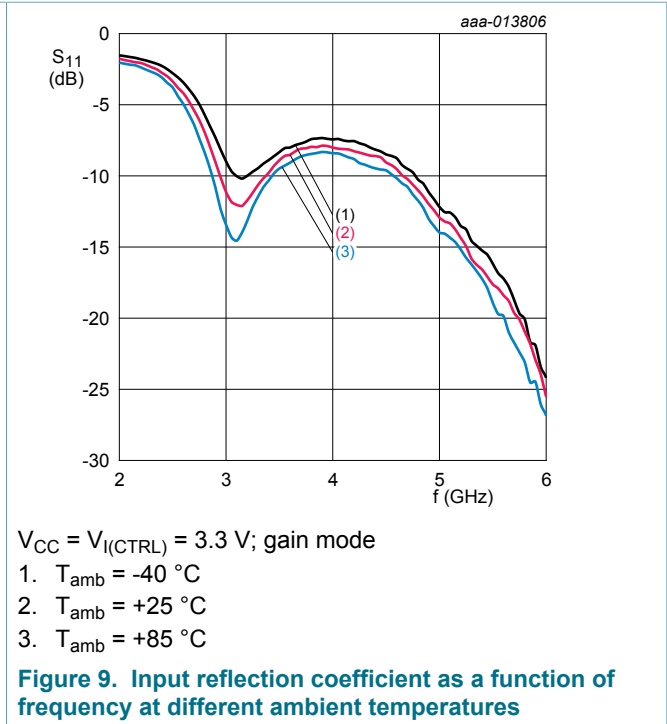
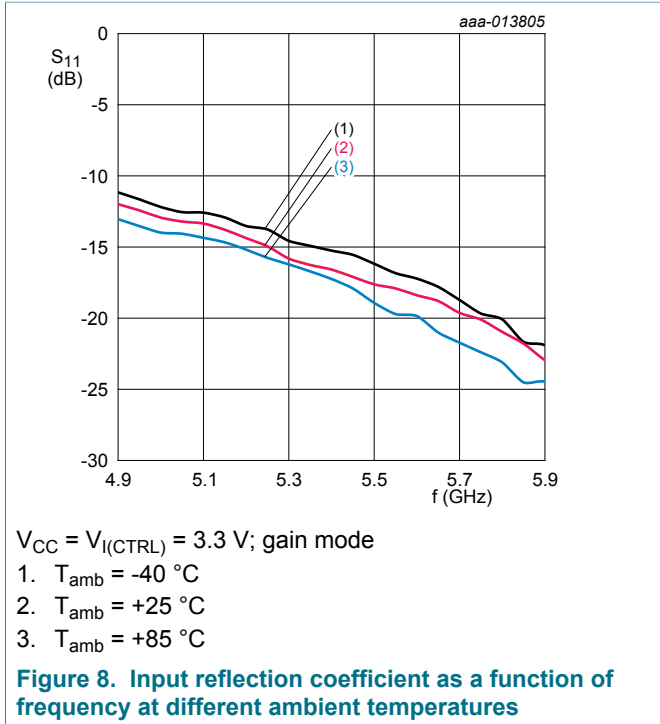

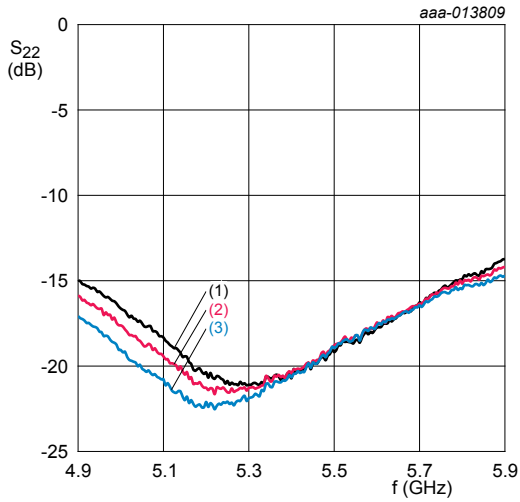

$V_{CC} = V_{I(CTRL)} = 3.3\text{ V}$; gain mode

1. $T_{amb} = -40\text{ }^{\circ}\text{C}$
2. $T_{amb} = +25\text{ }^{\circ}\text{C}$
3. $T_{amb} = +85\text{ }^{\circ}\text{C}$

Figure 12. Output reflection coefficient as a function of frequency at different ambient temperatures

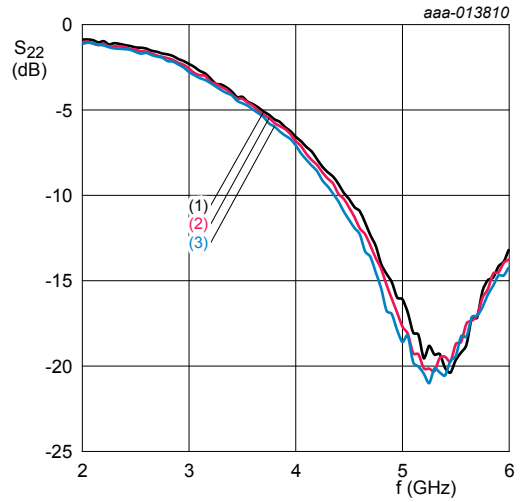

$V_{CC} = V_{I(CTRL)} = 3.3\text{ V}$; gain mode

1. $T_{amb} = -40\text{ }^{\circ}\text{C}$
2. $T_{amb} = +25\text{ }^{\circ}\text{C}$
3. $T_{amb} = +85\text{ }^{\circ}\text{C}$

Figure 13. Output reflection coefficient as a function of frequency at different ambient temperatures

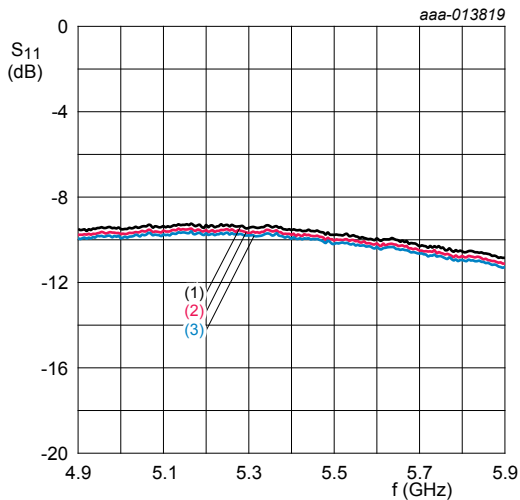

$T_{amb} = 25\text{ }^{\circ}\text{C}$; $V_{I(CTRL)} = 0\text{ V}$; bypass mode

1. $V_{CC} = 3.0\text{ V}$
2. $V_{CC} = 3.3\text{ V}$
3. $V_{CC} = 3.6\text{ V}$

Figure 14. Input reflection coefficient as a function of frequency at different supply voltages

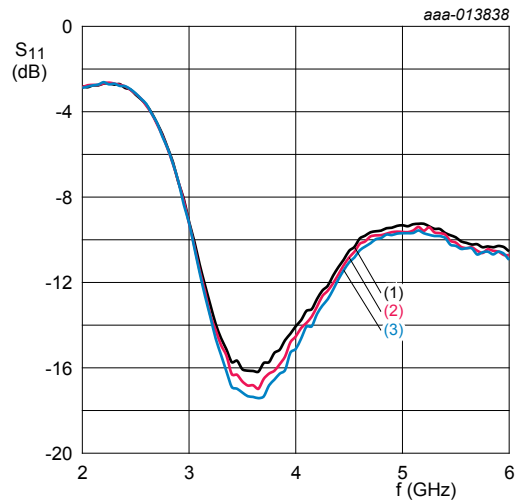

$T_{amb} = 25\text{ }^{\circ}\text{C}$; $V_{I(CTRL)} = 0\text{ V}$; bypass mode

1. $V_{CC} = 3.0\text{ V}$
2. $V_{CC} = 3.3\text{ V}$
3. $V_{CC} = 3.6\text{ V}$

Figure 15. Input reflection coefficient as a function of frequency at different supply voltages

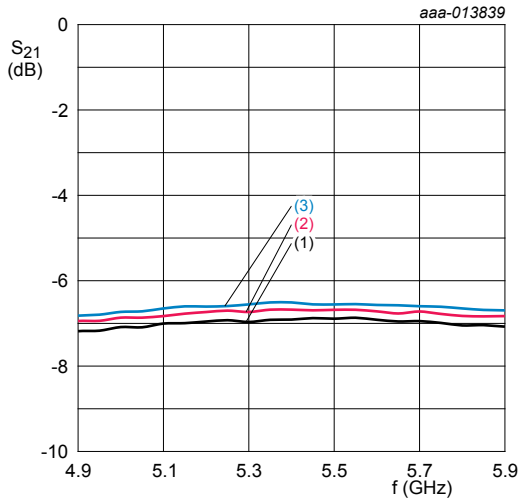

$T_{amb} = 25\text{ }^{\circ}\text{C}; V_{I(CTRL)} = 0\text{ V};$ bypass mode
 1. $V_{CC} = 3.0\text{ V}$
 2. $V_{CC} = 3.3\text{ V}$
 3. $V_{CC} = 3.6\text{ V}$

Figure 16. Forward transmission coefficient as a function of frequency at different supply voltages

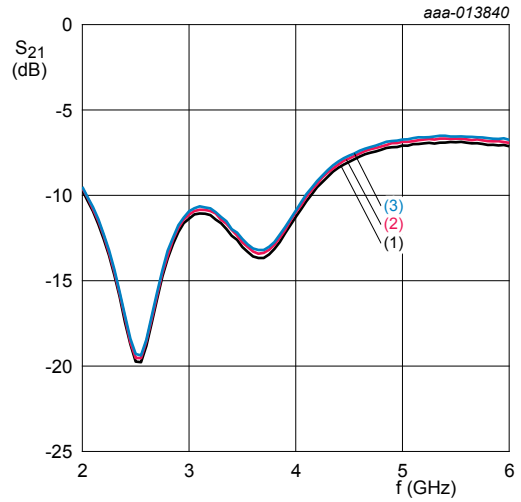

$T_{amb} = 25\text{ }^{\circ}\text{C}; V_{I(CTRL)} = 0\text{ V};$ bypass mode
 1. $V_{CC} = 3.0\text{ V}$
 2. $V_{CC} = 3.3\text{ V}$
 3. $V_{CC} = 3.6\text{ V}$

Figure 17. Forward transmission coefficient as a function of frequency at different supply voltages

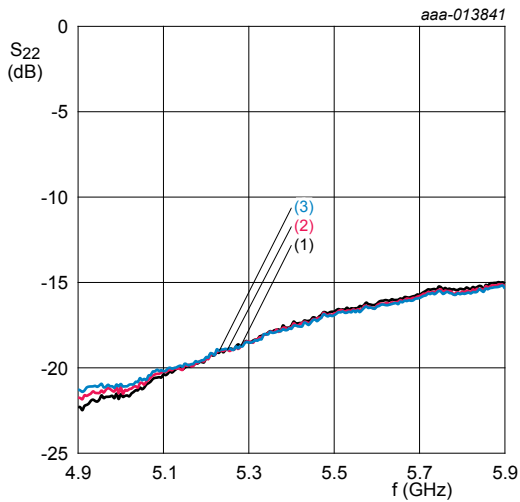

$T_{amb} = 25\text{ }^{\circ}\text{C}; V_{I(CTRL)} = 0\text{ V};$ bypass mode
 1. $V_{CC} = 3.0\text{ V}$
 2. $V_{CC} = 3.3\text{ V}$
 3. $V_{CC} = 3.6\text{ V}$

Figure 18. Output reflection coefficient as a function of frequency at different supply voltages

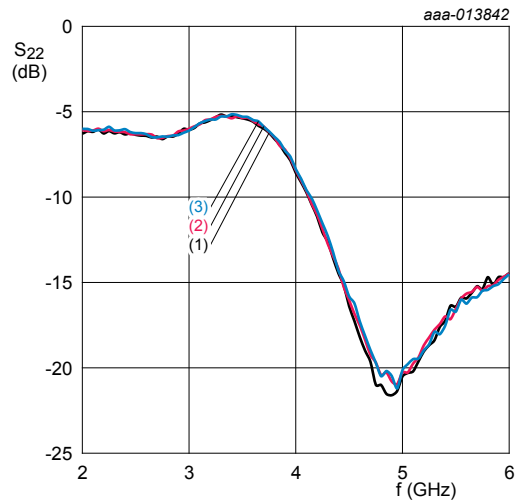

$T_{amb} = 25\text{ }^{\circ}\text{C}; V_{I(CTRL)} = 0\text{ V};$ bypass mode
 1. $V_{CC} = 3.0\text{ V}$
 2. $V_{CC} = 3.3\text{ V}$
 3. $V_{CC} = 3.6\text{ V}$

Figure 19. Output reflection coefficient as a function of frequency at different supply voltages

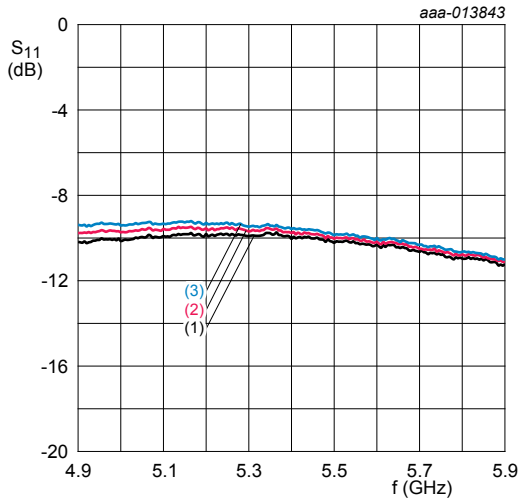

$V_{CC} = 3.3\text{ V}; V_{I(CTRL)} = 0\text{ V};$ bypass mode
 1. $T_{amb} = -40\text{ }^{\circ}\text{C}$
 2. $T_{amb} = +25\text{ }^{\circ}\text{C}$
 3. $T_{amb} = +85\text{ }^{\circ}\text{C}$

Figure 20. Input reflection coefficient as a function of frequency at different ambient temperatures

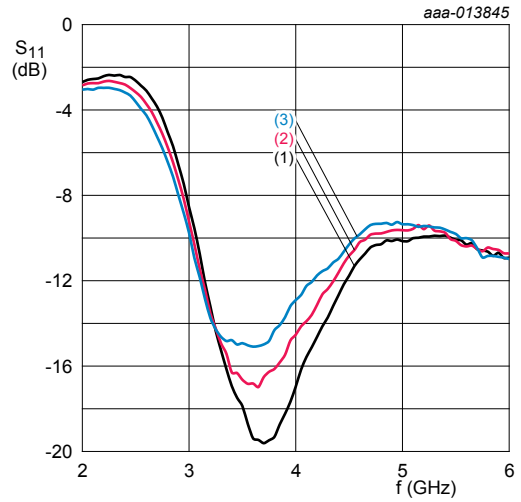

$V_{CC} = 3.3\text{ V}; V_{I(CTRL)} = 0\text{ V};$ bypass mode
 1. $T_{amb} = -40\text{ }^{\circ}\text{C}$
 2. $T_{amb} = +25\text{ }^{\circ}\text{C}$
 3. $T_{amb} = +85\text{ }^{\circ}\text{C}$

Figure 21. Input reflection coefficient as a function of frequency at different ambient temperatures

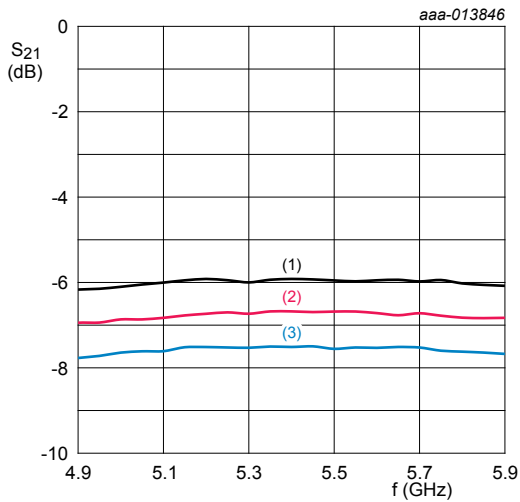

$V_{CC} = 3.3\text{ V}; V_{I(CTRL)} = 0\text{ V};$ bypass mode
 1. $T_{amb} = -40\text{ }^{\circ}\text{C}$
 2. $T_{amb} = +25\text{ }^{\circ}\text{C}$
 3. $T_{amb} = +85\text{ }^{\circ}\text{C}$

Figure 22. Forward transmission coefficient as a function of frequency at different ambient temperatures

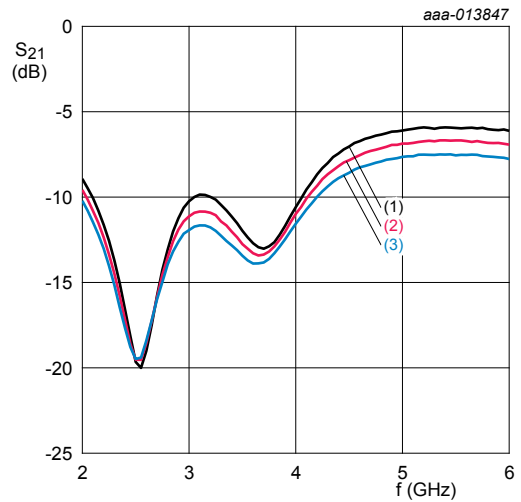

$V_{CC} = 3.3\text{ V}; V_{I(CTRL)} = 0\text{ V};$ bypass mode
 1. $T_{amb} = -40\text{ }^{\circ}\text{C}$
 2. $T_{amb} = +25\text{ }^{\circ}\text{C}$
 3. $T_{amb} = +85\text{ }^{\circ}\text{C}$

Figure 23. Forward transmission coefficient as a function of frequency at different ambient temperatures

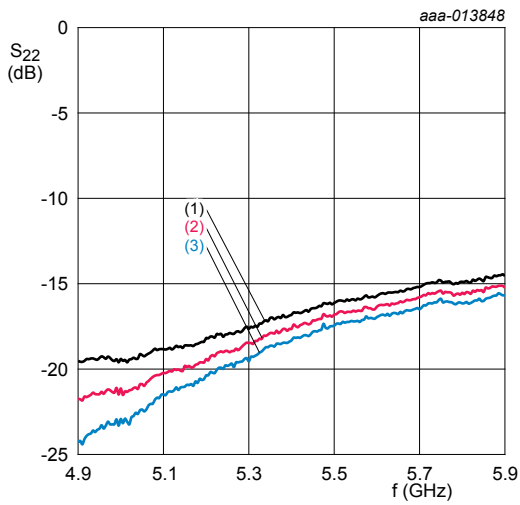

$V_{CC} = 3.3 \text{ V}$; $V_{I(CTRL)} = 0 \text{ V}$; bypass mode

1. $T_{amb} = -40 \text{ }^\circ\text{C}$
2. $T_{amb} = +25 \text{ }^\circ\text{C}$
3. $T_{amb} = +85 \text{ }^\circ\text{C}$

Figure 24. Output reflection coefficient as a function of frequency at different ambient temperatures

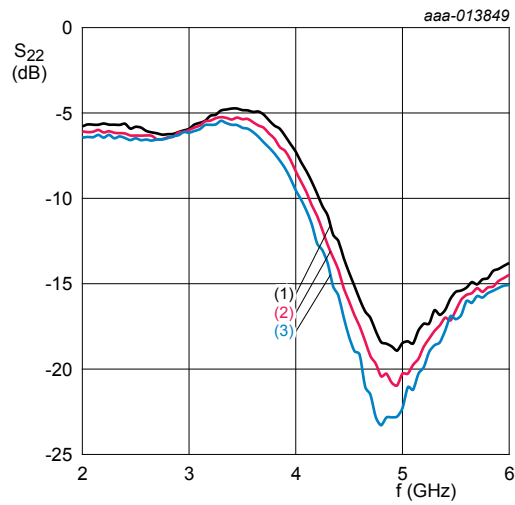

$V_{CC} = 3.3 \text{ V}$; $V_{I(CTRL)} = 0 \text{ V}$; bypass mode

1. $T_{amb} = -40 \text{ }^\circ\text{C}$
2. $T_{amb} = +25 \text{ }^\circ\text{C}$
3. $T_{amb} = +85 \text{ }^\circ\text{C}$

Figure 25. Output reflection coefficient as a function of frequency at different ambient temperatures

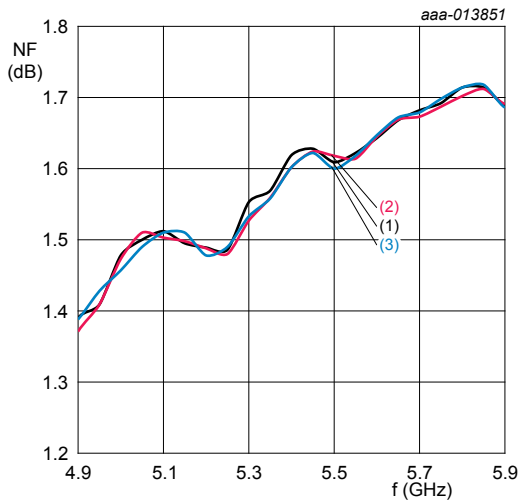

$T_{amb} = 25 \text{ }^\circ\text{C}$; gain mode

1. $V_{CC} = V_{I(CTRL)} = 3.0 \text{ V}$
2. $V_{CC} = V_{I(CTRL)} = 3.3 \text{ V}$
3. $V_{CC} = V_{I(CTRL)} = 3.6 \text{ V}$

Figure 26. Noise figure as a function of frequency at different supply voltages

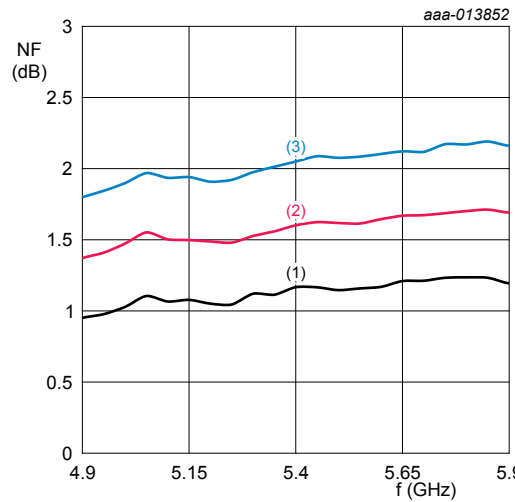

$V_{CC} = V_{I(CTRL)} = 3.3 \text{ V}$; gain mode

1. $T_{amb} = -40 \text{ }^\circ\text{C}$
2. $T_{amb} = +25 \text{ }^\circ\text{C}$
3. $T_{amb} = +85 \text{ }^\circ\text{C}$

Figure 27. Noise figure as a function of frequency at different ambient temperatures

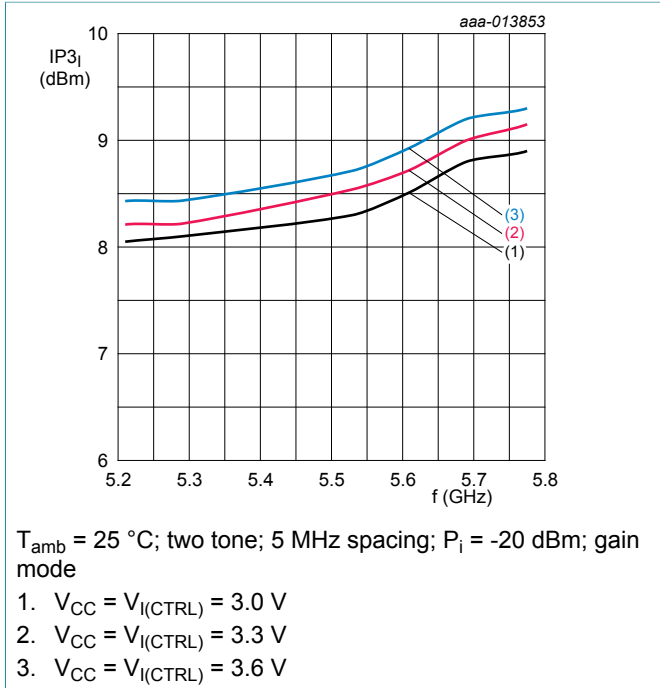

$T_{amb} = 25\text{ }^{\circ}\text{C}$; two tone; 5 MHz spacing; $P_i = -20\text{ dBm}$; gain mode

1. $V_{CC} = V_{I(CTRL)} = 3.0\text{ V}$
2. $V_{CC} = V_{I(CTRL)} = 3.3\text{ V}$
3. $V_{CC} = V_{I(CTRL)} = 3.6\text{ V}$

Figure 28. Input third-order intercept point as a function of frequency at different supply voltages

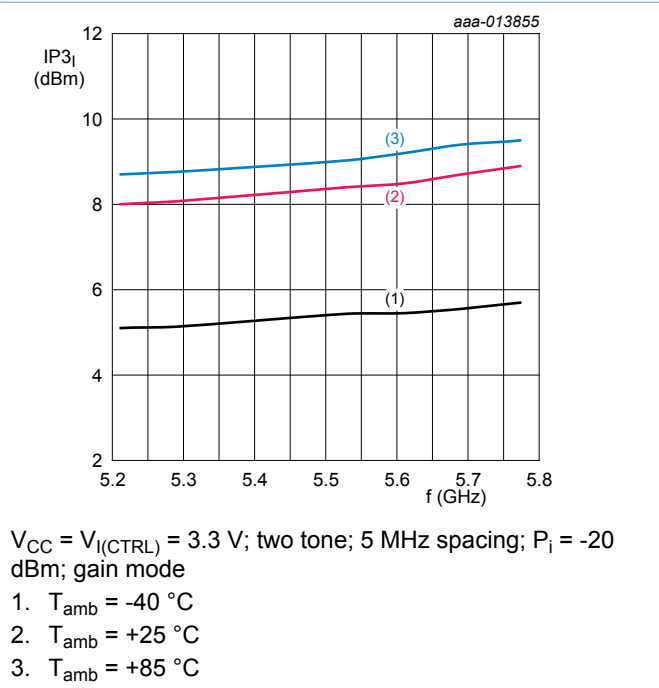

$V_{CC} = V_{I(CTRL)} = 3.3\text{ V}$; two tone; 5 MHz spacing; $P_i = -20\text{ dBm}$; gain mode

1. $T_{amb} = -40\text{ }^{\circ}\text{C}$
2. $T_{amb} = +25\text{ }^{\circ}\text{C}$
3. $T_{amb} = +85\text{ }^{\circ}\text{C}$

Figure 29. Input third-order intercept point as a function of frequency at different ambient temperatures

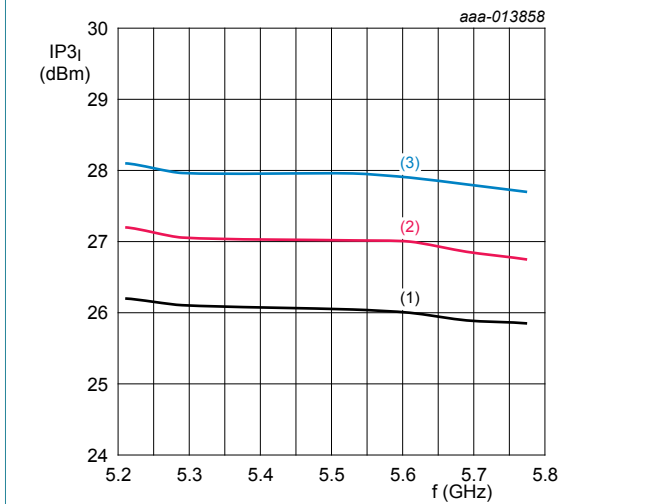

$T_{amb} = 25\text{ }^{\circ}\text{C}$; $V_{I(CTRL)} = 0\text{ V}$; two tone; 5 MHz spacing; $P_i = -5\text{ dBm}$; bypass mode

1. $V_{CC} = V_{I(CTRL)} = 3.0\text{ V}$
2. $V_{CC} = V_{I(CTRL)} = 3.3\text{ V}$
3. $V_{CC} = V_{I(CTRL)} = 3.6\text{ V}$

Figure 30. Input third-order intercept point as a function of frequency at different supply voltages

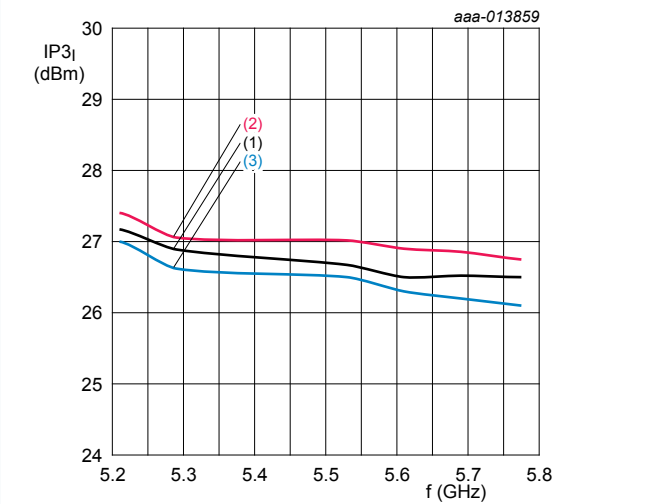

$V_{CC} = 3.3\text{ V}$; $V_{I(CTRL)} = 0\text{ V}$; two tone; 5 MHz spacing; $P_i = -5\text{ dBm}$; bypass mode

1. $T_{amb} = -40\text{ }^{\circ}\text{C}$
2. $T_{amb} = +25\text{ }^{\circ}\text{C}$
3. $T_{amb} = +85\text{ }^{\circ}\text{C}$

Figure 31. Input third-order intercept point as a function of frequency at different ambient temperatures

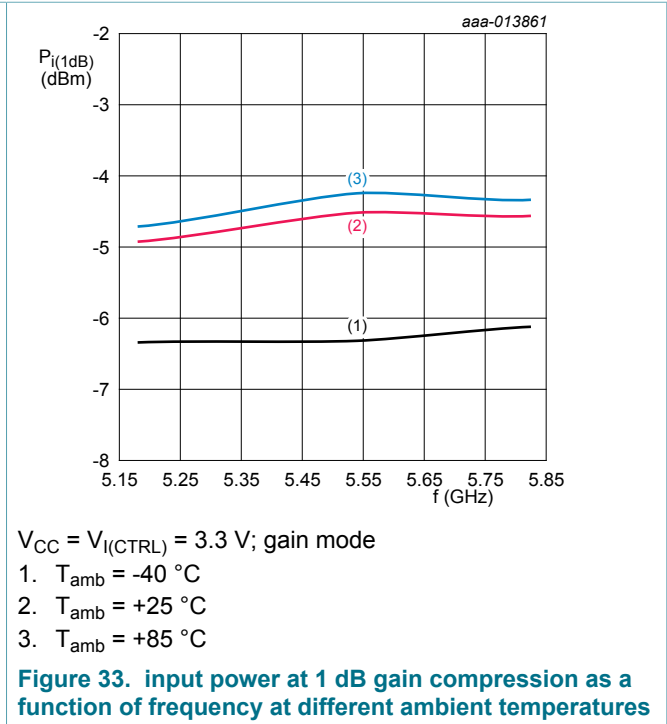
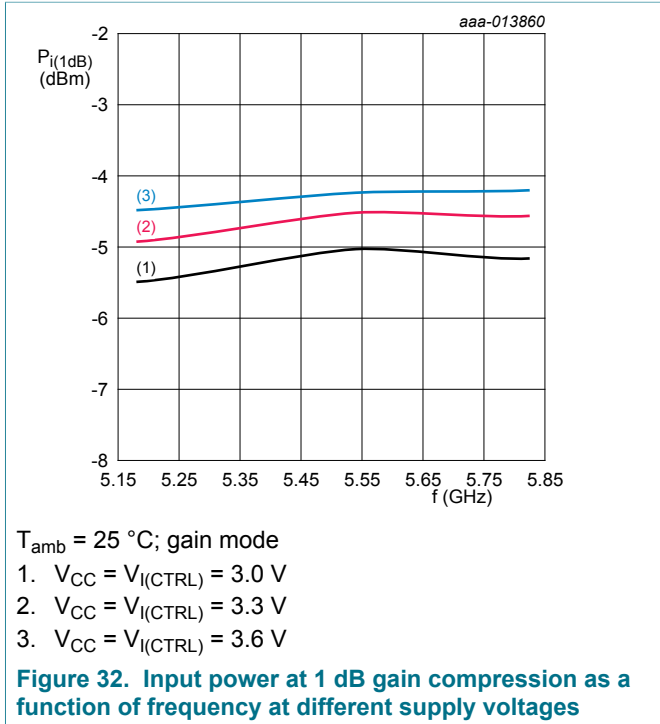

11.2 Application circuit

In [Figure 34](#) the application diagram as supplied on the evaluation board is given.

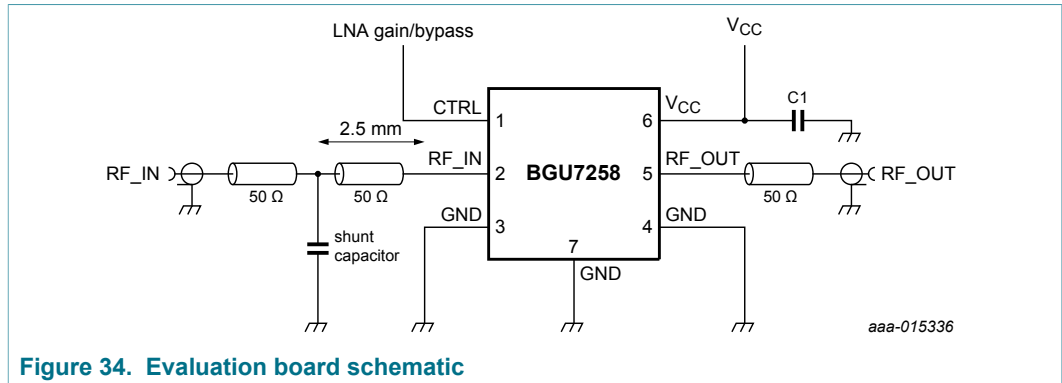

Note that in [Figure 34](#) the schematic for the BGU7258 evaluation board is shown using only two external components. A DC-decoupling capacitor placed close to V_{CC} (pin 6) and a matching shunt capacitor at RF_IN.

The BGU7258 can also be used without the matching capacitor at RF_IN. However, in this case the gain will be 0.5 dB lower, the noise figure 0.1 dB higher and the input return loss less than 10 dB (approximately 8 dB) over the whole 5 GHz ISM band (5 GHz to 6 GHz).

Table 10. List of components

See [Figure 34](#) for evaluation board schematic.

Preferred vendors different from the ones listed can be chosen, but be aware that the performance could be affected.

Component	Description	Value	Remarks
C1	capacitor	4.7 nF	Murata GRM155 series
shunt capacitor	capacitor	0.3 pF	Murata GJM155 series
RF_IN, RF_OUT	SMA connector	-	Emerson Network Power
V _{CC} , LNA gain/bypass	3-pin connector	-	Molex

For more details or information see application note [AN11453](#).

12 Package outline

HXSON6: plastic, thermal enhanced extremely thin small outline package; no leads;
6 terminals; body 1.6 x 1.6 x 0.5 mm

SOT1189-1

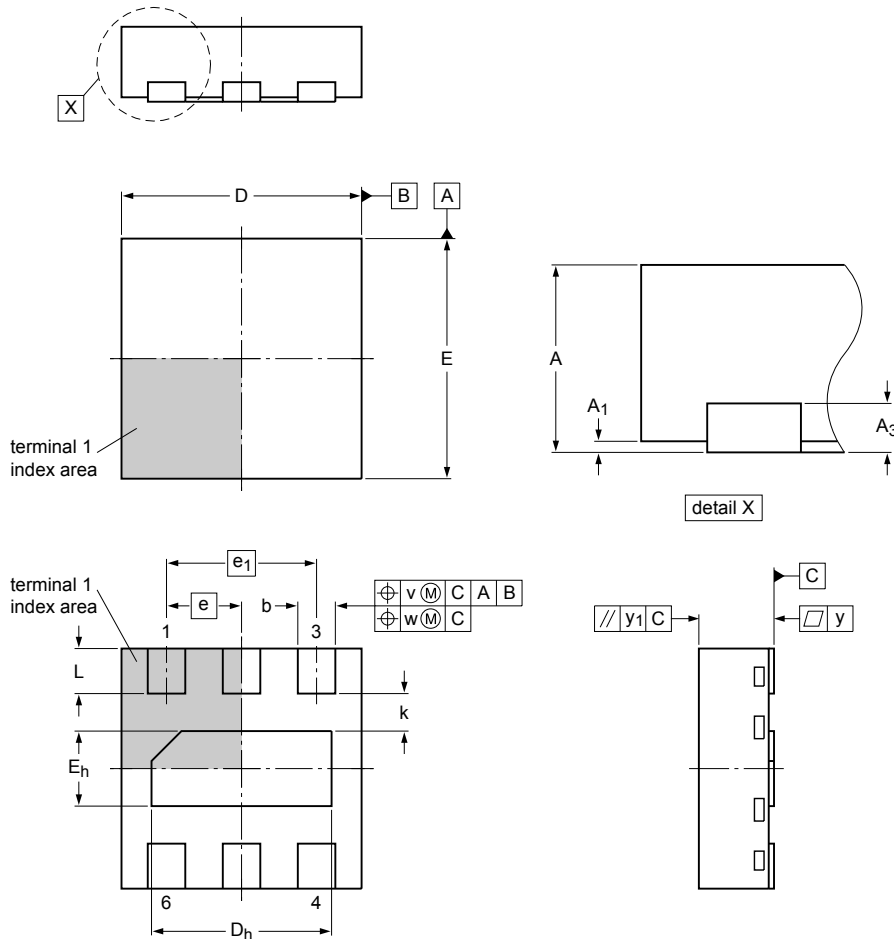

Dimensions

Unit ⁽¹⁾	A	A ₁	A ₃	b	D	D _h	E	E _h	e	e ₁	k	L	v	w	y	y ₁
max	0.50	0.05		0.30	1.7	1.3	1.7	0.6				0.35				
nom	0.48		0.127	0.25	1.6	1.2	1.6	0.5	0.5	1		0.30	0.1	0.05	0.05	0.05
min	0.46	0.00		0.20	1.5	1.1	1.5	0.4			0.2	0.25				

Note
1. Plastic or metal protrusions of 0.075 mm maximum per side are not included.

sot1189-1_po

Outline version	References			European projection	Issue date
	IEC	JEDEC	JEITA		
SOT1189-1	---	---	---		10-10-11 18-08-14

Figure 35. Package outline SOT1189-1 (HXSON6)

13 Soldering

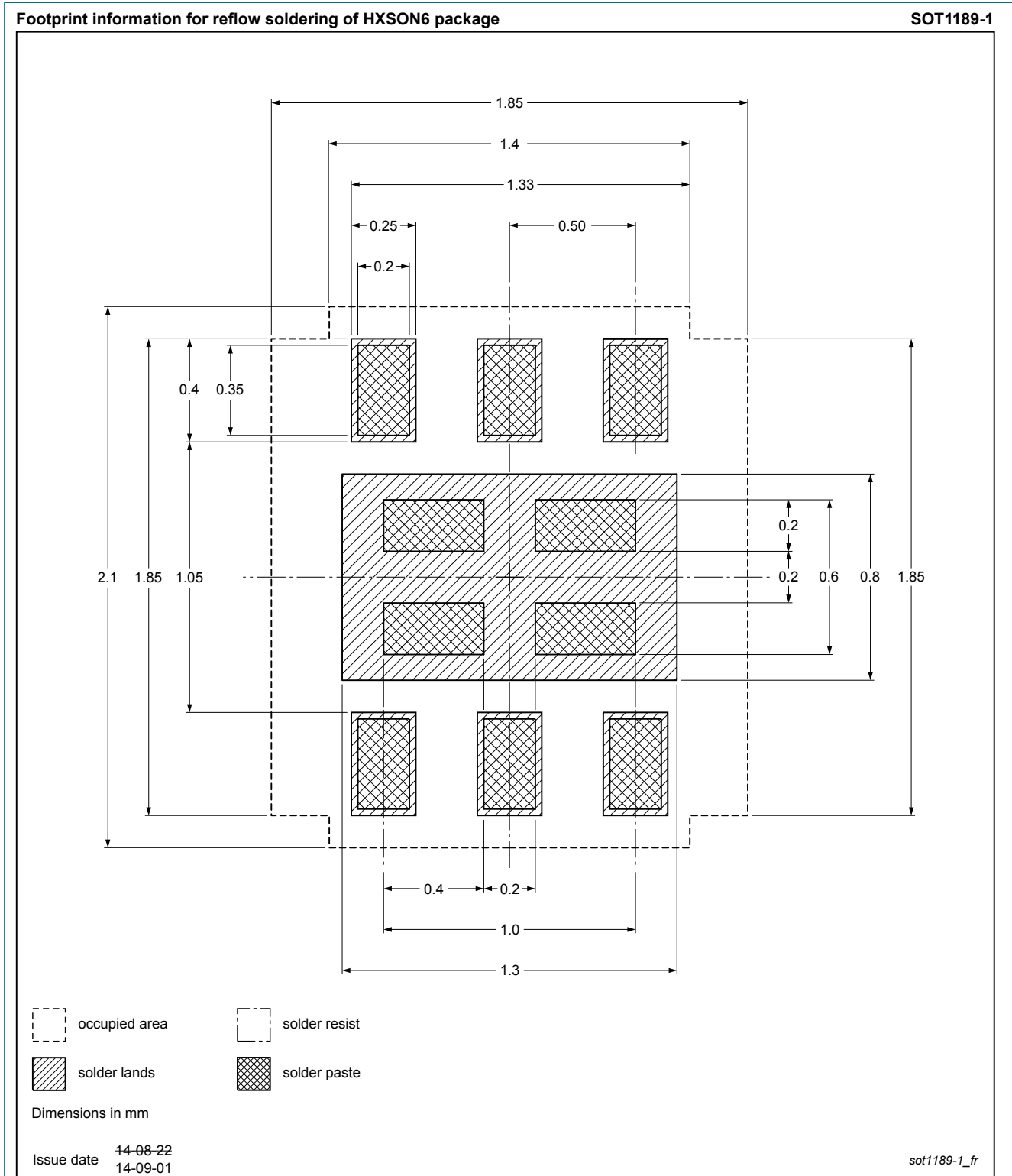

Figure 36. Reflow soldering footprint

14 Abbreviations

Table 11. Abbreviations

Acronym	Description
CW	continuous wave
ESD	electrostatic discharge
EVM	error vector magnitude
HBM	human body model
IEEE	institute of electrical and electronics engineers
ISM	industrial scientific medical
LTE	long-term evolution
LTE-U	long-term evolution unlicensed
MMIC	monolithic microwave-integrated circuit
MSL	moisture sensitivity level
RHF	RoHS halogen free
QFN	quad-flat no-leads
SiGe:C	silicon germanium carbon
SMA	sub miniature-version A
WLAN	wireless local area network

15 Revision history

Table 12. Revision history

Document ID	Release date	Data sheet status	Change notice	Supersedes
BGU7258 v.3	20180829	Product data sheet	-	BGU7258 v.2
Modifications:	Package outline changed			
BGU7258 v.2	20141030	Product data sheet	-	BGU7258 v.1
Modifications:	• The status of this document has been changed to Product data sheet.			
BGU7258 v.1	20141023	Preliminary data sheet	-	-

16 Legal information

16.1 Data sheet status

Document status ^{[1][2]}	Product status ^[3]	Definition
Objective [short] data sheet	Development	This document contains data from the objective specification for product development.
Preliminary [short] data sheet	Qualification	This document contains data from the preliminary specification.
Product [short] data sheet	Production	This document contains the product specification.

[1] Please consult the most recently issued document before initiating or completing a design.

[2] The term 'short data sheet' is explained in section "Definitions".

[3] The product status of device(s) described in this document may have changed since this document was published and may differ in case of multiple devices. The latest product status information is available on the Internet at URL <http://www.nxp.com>.

16.2 Definitions

Draft — The document is a draft version only. The content is still under internal review and subject to formal approval, which may result in modifications or additions. NXP Semiconductors does not give any representations or warranties as to the accuracy or completeness of information included herein and shall have no liability for the consequences of use of such information.

Short data sheet — A short data sheet is an extract from a full data sheet with the same product type number(s) and title. A short data sheet is intended for quick reference only and should not be relied upon to contain detailed and full information. For detailed and full information see the relevant full data sheet, which is available on request via the local NXP Semiconductors sales office. In case of any inconsistency or conflict with the short data sheet, the full data sheet shall prevail.

Product specification — The information and data provided in a Product data sheet shall define the specification of the product as agreed between NXP Semiconductors and its customer, unless NXP Semiconductors and customer have explicitly agreed otherwise in writing. In no event however, shall an agreement be valid in which the NXP Semiconductors product is deemed to offer functions and qualities beyond those described in the Product data sheet.

16.3 Disclaimers

Limited warranty and liability — Information in this document is believed to be accurate and reliable. However, NXP Semiconductors does not give any representations or warranties, expressed or implied, as to the accuracy or completeness of such information and shall have no liability for the consequences of use of such information. NXP Semiconductors takes no responsibility for the content in this document if provided by an information source outside of NXP Semiconductors. In no event shall NXP Semiconductors be liable for any indirect, incidental, punitive, special or consequential damages (including - without limitation - lost profits, lost savings, business interruption, costs related to the removal or replacement of any products or rework charges) whether or not such damages are based on tort (including negligence), warranty, breach of contract or any other legal theory. Notwithstanding any damages that customer might incur for any reason whatsoever, NXP Semiconductors' aggregate and cumulative liability towards customer for the products described herein shall be limited in accordance with the Terms and conditions of commercial sale of NXP Semiconductors.

Right to make changes — NXP Semiconductors reserves the right to make changes to information published in this document, including without limitation specifications and product descriptions, at any time and without notice. This document supersedes and replaces all information supplied prior to the publication hereof.

Suitability for use — NXP Semiconductors products are not designed, authorized or warranted to be suitable for use in life support, life-critical or safety-critical systems or equipment, nor in applications where failure or malfunction of an NXP Semiconductors product can reasonably be expected to result in personal injury, death or severe property or environmental damage. NXP Semiconductors and its suppliers accept no liability for inclusion and/or use of NXP Semiconductors products in such equipment or applications and therefore such inclusion and/or use is at the customer's own risk.

Applications — Applications that are described herein for any of these products are for illustrative purposes only. NXP Semiconductors makes no representation or warranty that such applications will be suitable for the specified use without further testing or modification. Customers are responsible for the design and operation of their applications and products using NXP Semiconductors products, and NXP Semiconductors accepts no liability for any assistance with applications or customer product design. It is customer's sole responsibility to determine whether the NXP Semiconductors product is suitable and fit for the customer's applications and products planned, as well as for the planned application and use of customer's third party customer(s). Customers should provide appropriate design and operating safeguards to minimize the risks associated with their applications and products. NXP Semiconductors does not accept any liability related to any default, damage, costs or problem which is based on any weakness or default in the customer's applications or products, or the application or use by customer's third party customer(s). Customer is responsible for doing all necessary testing for the customer's applications and products using NXP Semiconductors products in order to avoid a default of the applications and the products or of the application or use by customer's third party customer(s). NXP does not accept any liability in this respect.

Limiting values — Stress above one or more limiting values (as defined in the Absolute Maximum Ratings System of IEC 60134) will cause permanent damage to the device. Limiting values are stress ratings only and (proper) operation of the device at these or any other conditions above those given in the Recommended operating conditions section (if present) or the Characteristics sections of this document is not warranted. Constant or repeated exposure to limiting values will permanently and irreversibly affect the quality and reliability of the device.

Terms and conditions of commercial sale — NXP Semiconductors products are sold subject to the general terms and conditions of commercial sale, as published at <http://www.nxp.com/profile/terms>, unless otherwise agreed in a valid written individual agreement. In case an individual agreement is concluded only the terms and conditions of the respective agreement shall apply. NXP Semiconductors hereby expressly objects to applying the customer's general terms and conditions with regard to the purchase of NXP Semiconductors products by customer.

No offer to sell or license — Nothing in this document may be interpreted or construed as an offer to sell products that is open for acceptance or the grant, conveyance or implication of any license under any copyrights, patents or other industrial or intellectual property rights.

Quick reference data — The Quick reference data is an extract of the product data given in the Limiting values and Characteristics sections of this document, and as such is not complete, exhaustive or legally binding.

Export control — This document as well as the item(s) described herein may be subject to export control regulations. Export might require a prior authorization from competent authorities.

Non-automotive qualified products — Unless this data sheet expressly states that this specific NXP Semiconductors product is automotive qualified, the product is not suitable for automotive use. It is neither qualified nor tested in accordance with automotive testing or application requirements. NXP Semiconductors accepts no liability for inclusion and/or use of non-automotive qualified products in automotive equipment or applications. In the event that customer uses the product for design-in and use in automotive applications to automotive specifications and standards, customer (a) shall use the product without NXP Semiconductors' warranty of the product for

such automotive applications, use and specifications, and (b) whenever customer uses the product for automotive applications beyond NXP Semiconductors' specifications such use shall be solely at customer's own risk, and (c) customer fully indemnifies NXP Semiconductors for any liability, damages or failed product claims resulting from customer design and use of the product for automotive applications beyond NXP Semiconductors' standard warranty and NXP Semiconductors' product specifications.

Translations — A non-English (translated) version of a document is for reference only. The English version shall prevail in case of any discrepancy between the translated and English versions.

16.4 Trademarks

Notice: All referenced brands, product names, service names and trademarks are the property of their respective owners.

Contents

1	Product profile	1
1.1	General description	1
1.2	Features and benefits	1
1.3	Applications	1
1.4	Quick reference data	2
2	Pinning information	2
3	Ordering information	2
4	Marking	3
5	Block diagram	3
6	Limiting values	4
7	Thermal characteristics	4
8	Static characteristics	5
9	Dynamic characteristics	5
10	Gain control	6
11	Application information	6
11.1	Graphs	6
11.2	Application circuit	14
12	Package outline	16
13	Soldering	17
14	Abbreviations	18
15	Revision history	18
16	Legal information	19

Please be aware that important notices concerning this document and the product(s) described herein, have been included in section 'Legal information'.

© NXP B.V. 2018.

All rights reserved.

For more information, please visit: <http://www.nxp.com>

For sales office addresses, please send an email to: salesaddresses@nxp.com

Date of release: 29 August 2018

Document identifier: BGU7258