

# TFF1044HN

Integrated mixer oscillator PLL for satellite quad LNB

Rev. 1 — 10 June 2015

Product data sheet

## 1. General description

---

The TFF1044HN is a 10.70 GHz to 12.75 GHz  $K_u$  band down converter for use in universal quad and quattro Low Noise Block (LNB) in satellite receiver systems. The device features two RF inputs (two polarizations) and four IF outputs (up to 4 active IF paths). It integrates bias generation and control for the required external LNA stages, image rejection filtering, LO generation, down-conversion mixers, IF amplifier stages, voltage and tone detection on each IF output (for polarization and band selection) and the 4 (IF channels)  $\times$  4 (2 polarizations, 2 bands) IF matrix switch. For flexibility, the gain can be controlled in three discrete stages, the polarization of the RF inputs can be swapped and the second stage LNA biasing control can be switched from pHEMT to BJT configuration.

## 2. Features and benefits

---

- Low current consumption integrated pre-amplifier, mixer, buffer amplifier and PLL synthesizer
- Integrated pHEMT/BJT bias control for external LNAs
- Flat gain over frequency
- Single 5 V supply pin
- Operates with a low cost 25 MHz crystal
- Crystal-controlled LO frequency generation, alignment free concept
- Dual simultaneously operating LO frequencies (9.75 GHz and 10.6 GHz)
- Adjustable step gain (30 dB, 33 dB and 36 dB)
- Integrated switch matrix
- Integrated voltage and tone detector
- Low phase noise
- Low spurious
- Low external component count
- Alignment-free concept
- 36-terminal leadless plastic thermally enhanced very thin profile land grid array package 5.0 mm  $\times$  5.0 mm  $\times$  0.72 mm

## 3. Applications

---

- Quad LNAs
- Quattro LNAs
- IP LNAs



## 4. Quick reference data

**Table 1. Quick reference data**

$V_{CC} = 5\text{ V}$ ;  $T_{amb} = 25\text{ °C}$ ;  $f_{LO} = 9.75\text{ GHz}$  or  $f_{LO} = 10.6\text{ GHz}$ ;  $f_{xtal} = 25\text{ MHz}$ ;  $Z_0 = 50\ \Omega$  for RF inputs and  $Z_0 = 75\ \Omega$  for IF outputs unless otherwise specified.

Symbol	Parameter	Conditions	Min	Typ	Max	Unit
$V_{CC}$	supply voltage	IF output AC coupled <a href="#">[1]</a>	4.3	5	5.6	V
$I_{CC}$	supply current	IF output AC externally coupled; excluding current for LNAs; single activated IF path <a href="#">[1]</a>	-	145	-	mA
$f_{RF}$	RF frequency		10.70	-	12.75	GHz
$G_{conv}$	conversion gain	$f_{IF} = 1450\text{ MHz}$ (low band); single activated IF path				
		low gain mode <a href="#">[2]</a>	-	30	-	dB
		medium gain mode <a href="#">[2]</a>	-	33	-	dB
		high gain mode <a href="#">[2]</a>	-	36	-	dB
$NF_{SSB}$	single sideband noise figure	high gain mode; $f_{IF} = 1450\text{ MHz}$ (low band) <a href="#">[2]</a>	-	8	-	dB
$S_{11}$	input reflection coefficient	$10.70\text{ GHz} \leq f_{RF} \leq 12.75\text{ GHz}$	-	-10	-	dB
$S_{22}$	output reflection coefficient	$950\text{ MHz} \leq f_{IF} \leq 2150\text{ MHz}$	-	-10	-	dB
$IP3_o$	output third-order intercept point	high gain mode; carrier power is -10 dBm (measured at IF output) <a href="#">[2]</a>	-	15	-	dBm

[1] DC values.

[2] See [Table 12](#) for conversion gain selection settings.

## 5. Ordering information

**Table 2. Ordering information**

Type number	Package		Version
	Name	Description	
TFF1044HN	HVLGA36	plastic thermal enhanced very thin profile land grid array package; no leads; 36 terminals;	SOT1359-1

6. Functional diagram

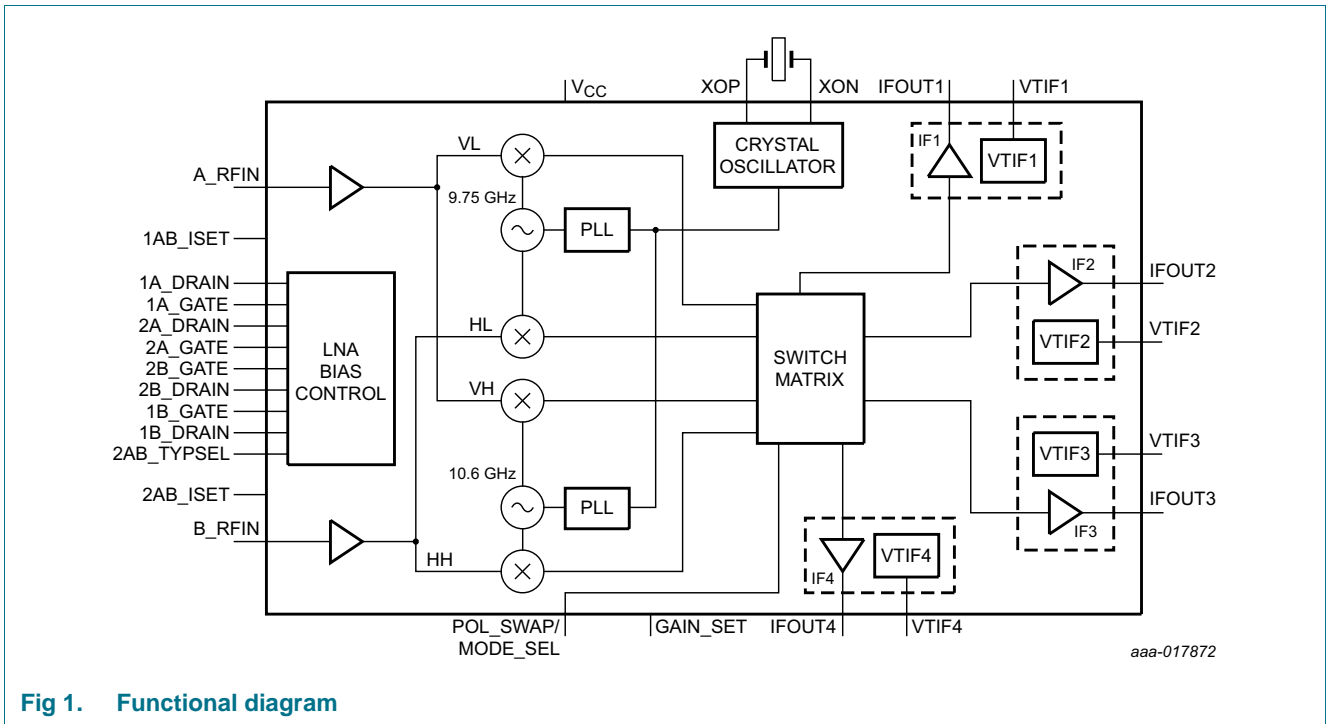

Fig 1. Functional diagram

## 7. Pinning information

### 7.1 Pinning

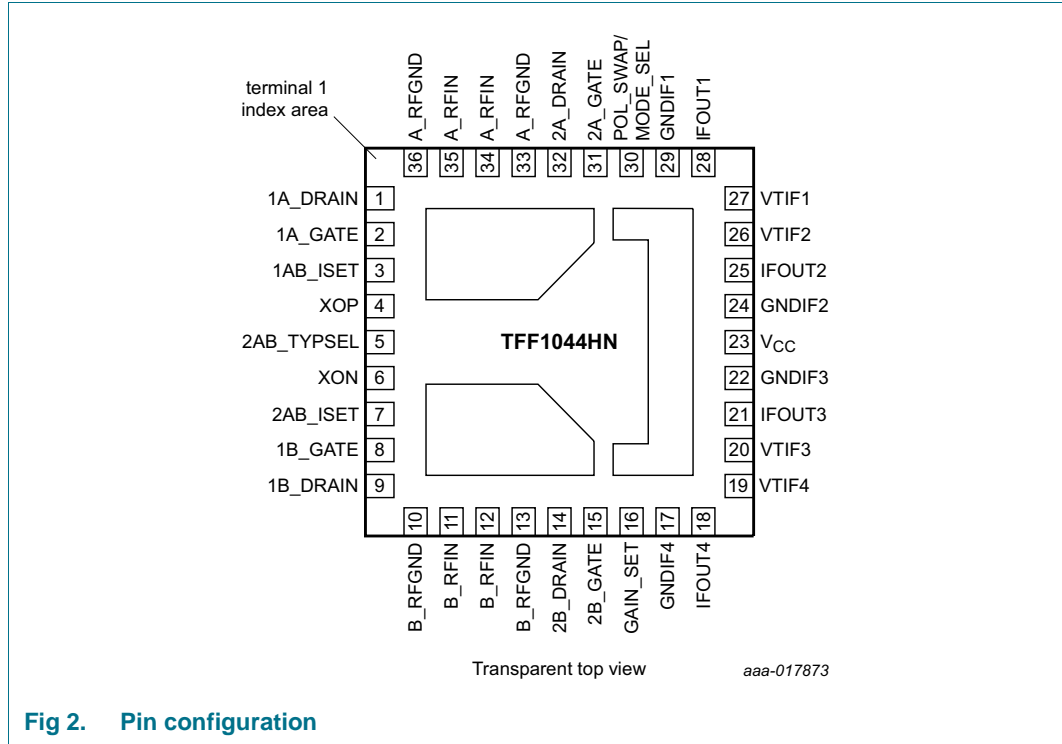

Fig 2. Pin configuration

### 7.2 Pin description

Table 3. Pin description

Symbol	Pin	Description
1A_DRAIN	1	Drain bias for the first stage LNA of RF path A
1A_GATE	2	Gate bias for the first stage LNA of RF path A
1AB_ISET	3	Drain current setting for first stage LNAs
XOP	4	External crystal (Xtal) positive connection. Connect Xtal between this pin and XON (pin 6)
2AB_TYPSEL	5	Second stage LNA type select: BJT/pHEMT
XON	6	External crystal (Xtal) negative connection. Connect Xtal between this pin and XOP (pin 4)
2AB_ISET	7	Drain/collector current setting for second stage LNAs
1B_GATE	8	Gate bias for the first stage LNA of RF path B
1B_DRAIN	9	Drain bias for the first stage LNA of RF path B
B_RFGND	10	RF ground of path B. Connect this pin to the exposed die pad landing and the RF input transmission line
B_RFIN	11	RF input of path B. AC coupled; DC grounded
B_RFIN	12	RF input of path B. AC coupled, DC grounded
B_RFGND	13	RF ground of path B. Connect this pin to the exposed die pad landing and the RF input transmission line

Table 3. Pin description ...continued

Symbol	Pin	Description
2B_DRAIN	14	Drain bias for the second stage LNA of RF path B
2B_GATE	15	Gate bias for the second stage LNA of RF path B
GAIN_SET	16	Conversion gain setting pin
GNDIF4	17	Ground connection of IFOUT4. Connect this pin to the exposed die pad landing and the output transmission line ground.
IFOUT4	18	IF output 4
VTIF4	19	Voltage and tone detector input for polarity and band selection of IFOUT4
VTIF3	20	Voltage and tone detector input for polarity and band selection of IFOUT3
IFOUT3	21	IF output 3
GNDIF3	22	Ground connection of IFOUT3. Connect this pin to the exposed die pad landing and the output transmission line ground.
V <sub>CC</sub>	23	Supply voltage
GNDIF2	24	Ground connection of IFOUT2. Connect this pin to the exposed die pad landing and the output transmission line ground.
IFOUT2	25	IF output 2
VTIF2	26	Voltage and tone detector input for polarity and band selection of IFOUT2
VTIF1	27	Voltage and tone detector input for polarity and band selection of IFOUT1
IFOUT1	28	IF output 1
GNDIF1	29	Ground connection of IFOUT1. Connect this pin to the exposed die pad landing and the output transmission line ground.
POL_SWAP/MODE_SEL	30	Polarity preset for RF inputs and quad/quattro mode selection
2A_GATE	31	Gate bias for the second stage LNA of RF path A
2A_DRAIN	32	Drain bias for the second stage LNA of RF path A
A_RFGND	33	RF ground. Connect this pin to the exposed die pad landing and the RF input transmission line
A_RFIN	34	RF input of path A. AC coupled, DC grounded
A_RFIN	35	RF input of path A. AC coupled, DC grounded
A_RFGND	36	RF ground. Connect this pin to the exposed die pad landing and the RF input transmission line
GND	exposed die pads	Ground; exposed die pads should be connected

## 8. Limiting values

Table 4. Limiting values

In accordance with the Absolute Maximum Rating System (IEC 60134).

Symbol	Parameter	Conditions	Min	Max	Unit
V <sub>CC</sub>	supply voltage		-0.5	+7	V
V <sub>ctrl</sub>	control voltage		[1][2] -0.5	+24	V
V <sub>th(bsel)(p-p)</sub>	peak-to-peak band selection threshold voltage	f <sub>p(ctrl)</sub> = 22 kHz	[2] -	2	V
P <sub>I(RF)</sub>	RF input power		-	0	dBm
T <sub>j</sub>	junction temperature		-	150	°C

**Table 4.** Limiting values ...continued

In accordance with the Absolute Maximum Rating System (IEC 60134).

Symbol	Parameter	Conditions	Min	Max	Unit
T <sub>stg</sub>	storage temperature		-40	+125	°C
V <sub>ESD</sub>	electrostatic discharge voltage	Human Body Model (HBM) According to ANSI/ESDA/JEDEC standard JS-001	-	±2	kV
		Charged Device Model (CDM) According to JEDEC standard JESD22-C101C	-	±2	kV

[1] DC values.

[2] On VTIF1 (pin 27), VTIF2 (pin 26), VTIF3 (pin 20) and VTIF4 (pin 19).

## 9. Recommended operating conditions

**Table 5.** Operating conditions

Symbol	Parameter	Conditions	Min	Typ	Max	Unit
V <sub>CC</sub>	supply voltage	IF output AC coupled [1]	4.3	5	5.6	V
V <sub>ctrl</sub>	control voltage	vertical selection [1][2]	8	-	14	V
		horizontal selection [1][2]	15.5	-	19	V
V <sub>th(bsel)(p-p)</sub>	peak-to-peak band selection threshold voltage	high band; f <sub>p(ctrl)</sub> = 22 kHz [2]	0.3	0.6	0.8	V
T <sub>amb</sub>	ambient temperature		-40	+25	+85	°C
Z <sub>0</sub>	characteristic impedance	RF inputs	-	50	-	Ω
		IF outputs	-	75	-	Ω
f <sub>RF</sub>	RF frequency		10.70	-	12.75	GHz
f <sub>LO</sub>	LO frequency	low band	-	9.75	-	GHz
		high band	-	10.6	-	GHz
f <sub>IF</sub>	IF frequency		0.95	-	2.15	GHz
C <sub>L(xtal)</sub>	crystal load capacitance		-	16	-	pF
ESR	equivalent series resistance		-	-	40	Ω
f <sub>xtal</sub>	crystal frequency		-	25	-	MHz

[1] DC values.

[2] On VTIF1 (pin 27), VTIF2 (pin 26), VTIF3 (pin 20) and VTIF4 (pin 19).

## 10. Thermal characteristics

**Table 6.** Thermal characteristics

Symbol	Parameter	Conditions	Typ	Unit	
R <sub>th(j-c)</sub>	thermal resistance from junction to case		[1]	10	K/W

[1] Simulated using finite element method resembling the device mounted in a typical application

## 11. Characteristics

**Table 7. Characteristics**

$V_{CC} = 5\text{ V}$ ;  $T_{amb} = 25\text{ }^{\circ}\text{C}$ ;  $f_{LO} = 9.75\text{ GHz}$  or  $f_{LO} = 10.6\text{ GHz}$ ;  $f_{xtal} = 25\text{ MHz}$ ;  $Z_0 = 50\text{ }\Omega$  for RF inputs and  $Z_0 = 75\text{ }\Omega$  for IF outputs unless otherwise specified.

Symbol	Parameter	Conditions	Min	Typ	Max	Unit
$I_{CC}$	supply current	IF output AC externally coupled; excluding current for LNAs				
		four activated IF paths <a href="#">[1]</a>	-	190	-	mA
		single activated IF path <a href="#">[1]</a>	-	145	-	mA
$I_D$	drain current	First stage LNAs				
		$R_{set\_12} = 22\text{ k}\Omega$ connected to 1AB_ISET (pin 3)	8	10	12	mA
		$15\text{ k}\Omega \leq R_{set\_12} \leq 220\text{ k}\Omega$	1	-	15	mA
		Second stage LNAs				
		$R_{set\_34} = 22\text{ k}\Omega$ connected to 2AB_ISET (pin 7)	8	10	12	mA
		$15\text{ k}\Omega \leq R_{set\_34} \leq 220\text{ k}\Omega$	1	-	15	mA
$V_D$	drain voltage	First stage LNAs <a href="#">[2]</a>				
		$R_{set\_12} = 22\text{ k}\Omega$	1.8	2	2.2	V
		$15\text{ k}\Omega \leq R_{set\_12} \leq 220\text{ k}\Omega$	1.75	-	2.3	V
		no transistor attached	-	2.7	-	V
		Second stage LNAs (pHEMT) <a href="#">[2][3]</a>				
		$R_{set\_34} = 22\text{ k}\Omega$	1.8	2	2.2	V
		$15\text{ k}\Omega \leq R_{set\_34} \leq 220\text{ k}\Omega$	1.75	-	2.3	V
		no transistor attached	-	2.7	-	V
		$V_C$	collector voltage	Second stage LNAs (BJT) <a href="#">[2][4]</a>		
$R_{set\_34} = 22\text{ k}\Omega$	1.8			2	2.2	V
$15\text{ k}\Omega \leq R_{set\_34} \leq 220\text{ k}\Omega$	1.75			-	2.3	V
no transistor attached	-			2.7	-	V
$V_O$	output voltage	First stage LNAs; $I_G = 10\text{ }\mu\text{A}$ <a href="#">[5]</a>	-	-0.9	-	V
		Second stage LNAs <a href="#">[5]</a>				
		second stage LNA = pHEMT; $I_G = 10\text{ }\mu\text{A}$ <a href="#">[3]</a>	-	-0.9	-	V
		second stage LNA = BJT; $I_B = 50\text{ }\mu\text{A}$ <a href="#">[4]</a>	-	1.4	-	V
$G_{conv}$	conversion gain	$f_{IF} = 1450\text{ MHz}$ (low band); single activated IF path				
		low gain mode <a href="#">[6]</a>	-	30	-	dB
		medium gain mode <a href="#">[6]</a>	-	33	-	dB
		high gain mode <a href="#">[6]</a>	-	36	-	dB
		$f_{IF} = 1650\text{ MHz}$ (high band); single activated IF path				
		low gain mode <a href="#">[6]</a>	-	30	-	dB
		medium gain mode <a href="#">[6]</a>	-	33	-	dB
high gain mode <a href="#">[6]</a>	-	36	-	dB		

**Table 7. Characteristics ...continued**

$V_{CC} = 5\text{ V}$ ;  $T_{amb} = 25\text{ }^{\circ}\text{C}$ ;  $f_{LO} = 9.75\text{ GHz}$  or  $f_{LO} = 10.6\text{ GHz}$ ;  $f_{xtal} = 25\text{ MHz}$ ;  $Z_0 = 50\text{ }\Omega$  for RF inputs and  $Z_0 = 75\text{ }\Omega$  for IF outputs unless otherwise specified.

Symbol	Parameter	Conditions	Min	Typ	Max	Unit
$\Delta G_{conv}/\Delta f$	conversion gain variation with frequency	$950\text{ MHz} \leq f_{IF} \leq 2150\text{ MHz}$	-	1.0	-	dB
		in every 36 MHz band	-	0.5	-	dB
$\Delta G_{conv}$	conversion gain variation	when switching from single activated IF path to multiple activated IF paths	-	1.5	-	dB
$NF_{SSB}$	single sideband noise figure	high gain mode [6]				
		$f_{IF} = 1450\text{ MHz}$ (low band)	-	8	-	dB
		$f_{IF} = 1650\text{ MHz}$ (high band)	-	8	-	dB
$S_{11}$	input reflection coefficient	$10.70\text{ GHz} \leq f_{RF} \leq 12.75\text{ GHz}$	-	-10	-	dB
$S_{22}$	output reflection coefficient	$950\text{ MHz} \leq f_{IF} \leq 2150\text{ MHz}$	-	-10	-	dB
$P_{L(1dB)}$	output power at 1 dB gain compression	high gain mode [6]	-	4.5	-	dBm
$IP3_o$	output third-order intercept point	high gain mode; carrier power is -10 dBm (measured at IF output) [6]	-	15	-	dBm
$\Phi_{n\lambda(itg)RMS}$	RMS integrated phase noise density	integration offset frequency = 10 kHz to 13 MHz	-	1.4	-	deg
IRR	image rejection ratio	[7]	-	17	-	dB
$\alpha_{isol(ch-ch)}$	isolation between channels	[7]	-	30	-	dBc
$\alpha_{L(RF)o}$	local oscillator RF leakage	$f_{LO} = 9.75\text{ GHz}$	-	-48	-	dBm
		$f_{LO} = 10.6\text{ GHz}$	-	-48	-	dBm
$\alpha_{L(IF)o}$	local oscillator IF leakage	$f_{LO} = 9.75\text{ GHz}$	-	-46	-	dBm
		$f_{LO} = 10.6\text{ GHz}$	-	-46	-	dBm
$P_{sp}$	spurious output power	at IF outputs within IF band; RBW = 30 kHz				
		in the presence of the signal; carrier power is -10 dBm (measured at IF output)	-	-	-40	dBc
		without RF signal; input terminated with 50 $\Omega$ ; medium gain mode [6]	-	-	-60	dBm
$f_{p(ctrl)}$	control pulse frequency	[8]	18	22	26	kHz
$V_{th(bsel)(p-p)}$	peak-to-peak band selection threshold voltage	$f_{p(ctrl)} = 22\text{ kHz}$ [8]	0.3	0.6	0.8	V
$V_{th(psel)}$	polarity selection threshold voltage	[1][8]	14	14.75	15.25	V
$R_{pd}$	pull-down resistance	on POL_SWAP/MODE_SEL (pin 30)	70	110	140	k $\Omega$
		on GAIN_SET (pin 16)	70	110	140	k $\Omega$
		on 2AB_TYPSEL (pin 5)	70	110	140	k $\Omega$

- [1] DC values.
- [2] For first stage LNA on 1A\_DRAIN (pin 1) or 1B\_DRAIN (pin 9); for second stage LNA on 2A\_DRAIN (pin 32) or 2B\_DRAIN (pin 14).
- [3] 2AB\_TYPSEL (pin 5) is connected to GND (pHEMT for second stage LNAs).
- [4] 2AB\_TYPSEL (pin 5) is floating (BJT transistor for second stage LNAs); first stage LNAs stay in the configuration for pHEMT biasing.
- [5] For first stage LNA on 1A\_GATE (pin 2) or 1B\_GATE (pin 8); for second stage LNA on 2A\_GATE (pin 31) or 2B\_GATE (pin 15).
- [6] See Table 12 for conversion gain selection settings.
- [7] Measured at low band ( $f_{IF} = 1450\text{ MHz}$ ) and high band ( $f_{IF} = 1650\text{ MHz}$ ); carrier power is -10 dB m (measured at IF output).
- [8] On VTIF1 (pin 27), VTIF2 (pin 26), VTIF3 (pin 20) and VTIF4 (pin 19).



### 11.1 Impedance information

**Table 8. Typical input impedance**  
For Smith chart see [Figure 27](#).

f (GHz)	Z <sub>i(A_RFIN)</sub> (Ω)	Z <sub>i(B_RFIN)</sub> (Ω)
10.70	52.650 + j14.850	37.350 + j18.200
11.20	64.450 + j2.900	41.850 + j19.950
11.70	62.600 – j11.500	49.700 + j16.350
12.20	60.400 – j13.000	59.600 + j7.250
12.75	54.950 – j7.900	69.300 – j10.600

## 12. Modes of operation

### 12.1 IF on/off and band/polarization control logic

Activation of the IF paths is determined by the voltage applied at their corresponding VT pins. When the DC voltage applied to any of these pins is lower than the expected minimum value, the corresponding IF path is turned off

Selection between vertical and horizontal polarizations for each path is determined by comparison of the DC voltage V<sub>ctrl</sub> applied at VTIF pin to a reference threshold voltage.

Selection between high band and low band depends on the presence of a 22 kHz pulse signal applied to the VTIF pin for each IF path. In order to improve the immunity against parasitic signals, the pulse amplitude must be larger than the threshold level for validating the switching to high-band.

In these aspects, TFF1044HN is controlled according to the logic specified in [Table 9](#).

**Table 9. IF and band/polarization control**

Voltage	Control pulse	IF path	Polarization	Band
V <sub>ctrl</sub> < 4 V	N/A	off	N/A	N/A
8 V < V <sub>ctrl</sub> < 14 V	no control pulse frequency; V <sub>th(bsel)(p-p)</sub> < 100 mV	on	vertical	low
	f <sub>p(ctrl)</sub> = 22 kHz; 300 mV < V <sub>th(bsel)(p-p)</sub> < 800 mV	on	vertical	high
15.5 V < V <sub>ctrl</sub> < 19 V	no control pulse frequency; V <sub>th(bsel)(p-p)</sub> < 100 mV	on	horizontal	low
	f <sub>p(ctrl)</sub> = 22 kHz; 300 mV < V <sub>th(bsel)(p-p)</sub> < 800 mV	on	horizontal	high

### 12.2 RF path assignment logic

The vertical and horizontal polarizations are assigned to the RF path A and RF path B inputs according to the logic [Table 10](#). The setting for quattro mode operation is also given in the same table.

**Table 10. polarity swap / mode selection settings**

connection of POL_SWAP/MODE_SEL (pin 30)	Mode	Polarity	
		RF input path A	RF input path B
GND	quad	horizontal	vertical
float	quad	vertical	horizontal
GND via 100 kΩ pull-down resistor	quattro <sup>[1]</sup>	N/A	N/A

[1] Quattro mode. See [Table 11](#) for polarization and band attribution to IF ports.

### 12.2.1 Quattro mode

When grounded via a 100 kΩ resistor, POL\_SWAP/MODE\_SEL (pin 30) sets the TFF1044HN in quattro mode where the IF outputs are attributed to a given polarization/band, irrespective of the signal applied to the VTIF pins.

Each IF output is assigned to a given polarization/band according to [Table 11](#):

**Table 11. IF output assignment**

IF output port	Polarization	Band
IFOUT1	A_RFIN	low
IFOUT2	A_RFIN	high
IFOUT3	B_RFIN	low
IFOUT4	B_RFIN	high

### 12.3 Conversion gain selection logic

The conversion gain shall be determined by the type of termination at GAIN\_SET (pin 16) following [Table 12](#).

**Table 12. Conversion gain settings**

Connection of GAIN_SET (pin 16)	Gain mode
GND	low
float	medium
GND via 100 kΩ pull-down resistor	high

### 12.4 LNA selection logic

The type of transistor used for the second LNA shall be selected depending on the state of 2AB\_TYPSEL (pin 5) according to [Table 13](#).

**Table 13. Second stage LNA type selection settings**

Connection of 2AB_TYPSEL (pin 5)	Type of second stage LNA	
	RF path A	RF path B
GND	pHEMT	pHEMT
float	BJT	BJT

13. Graphs

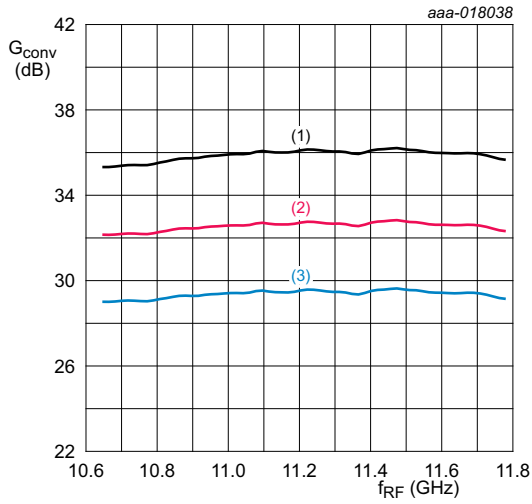

Measured from A\_RFIN to IFOUT1.  
Low band;  $V_{CC} = 5\text{ V}$ ;  $T_{amb} = 25\text{ }^{\circ}\text{C}$ .

- (1) High gain mode
- (2) Medium gain mode
- (3) Low gain mode

**Fig 3. Conversion gain as a function of RF frequency; typical values**

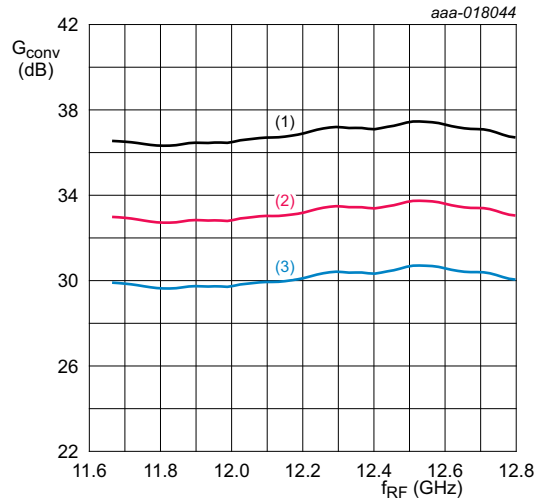

Measured from A\_RFIN to IFOUT1.  
High band;  $V_{CC} = 5\text{ V}$ ;  $T_{amb} = 25\text{ }^{\circ}\text{C}$ .

- (1) High gain mode
- (2) Medium gain mode
- (3) Low gain mode

**Fig 4. Conversion gain as a function of RF frequency; typical values**

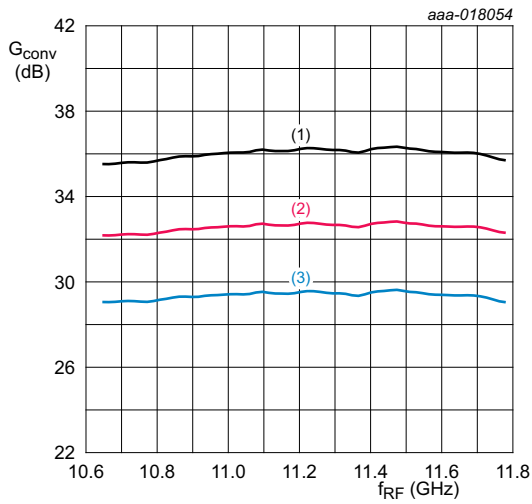

Measured from A\_RFIN to IFOUT2.  
Low band;  $V_{CC} = 5\text{ V}$ ;  $T_{amb} = 25\text{ }^{\circ}\text{C}$ .

- (1) High gain mode
- (2) Medium gain mode
- (3) Low gain mode

**Fig 5. Conversion gain as a function of RF frequency; typical values**

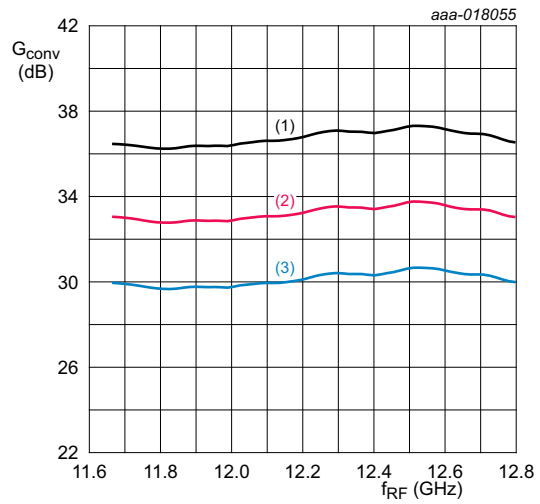

Measured from A\_RFIN to IFOUT2.  
High band;  $V_{CC} = 5\text{ V}$ ;  $T_{amb} = 25\text{ }^{\circ}\text{C}$ .

- (1) High gain mode
- (2) Medium gain mode
- (3) Low gain mode

**Fig 6. Conversion gain as a function of RF frequency; typical values**

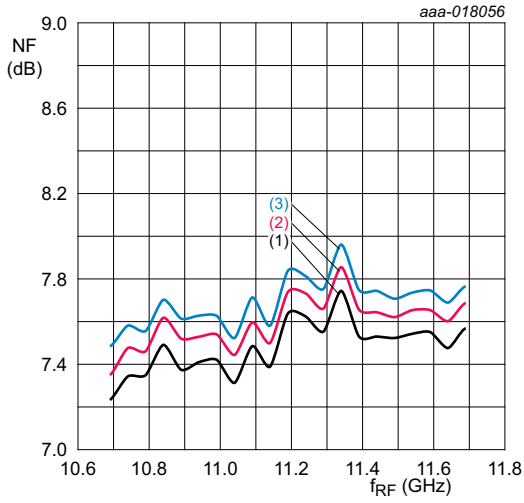

Measured from B\_RFIN to IFOUT1.  
Low band;  $V_{CC} = 5\text{ V}$ ;  $T_{amb} = 25\text{ }^{\circ}\text{C}$ .

- (1) High gain mode
- (2) Medium gain mode
- (3) Low gain mode

**Fig 7. Noise figure as a function of RF frequency; typical values**

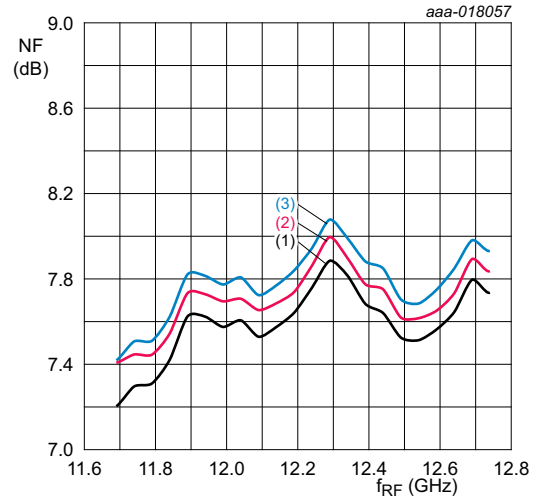

Measured from B\_RFIN to IFOUT1.  
High band;  $V_{CC} = 5\text{ V}$ ;  $T_{amb} = 25\text{ }^{\circ}\text{C}$ .

- (1) High gain mode
- (2) Medium gain mode
- (3) Low gain mode

**Fig 8. Noise figure as a function of RF frequency; typical values**

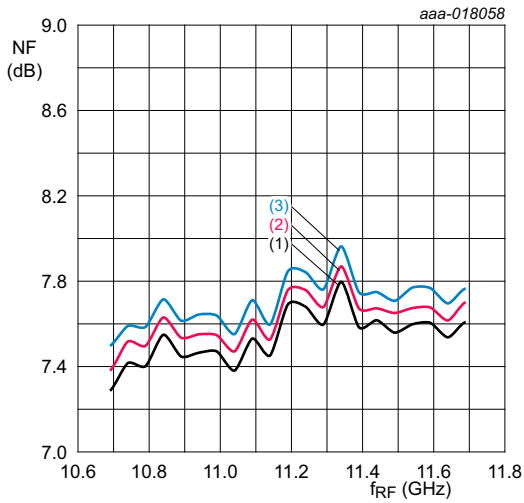

Measured from B\_RFIN to IFOUT2.  
Low band;  $V_{CC} = 5\text{ V}$ ;  $T_{amb} = 25\text{ }^{\circ}\text{C}$ .

- (1) High gain mode
- (2) Medium gain mode
- (3) Low gain mode

**Fig 9. Noise figure as a function of RF frequency; typical values**

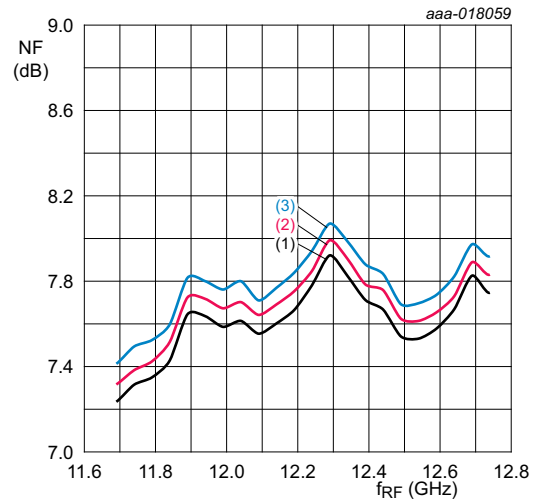

Measured from B\_RFIN to IFOUT2.  
High band;  $V_{CC} = 5\text{ V}$ ;  $T_{amb} = 25\text{ }^{\circ}\text{C}$ .

- (1) High gain mode
- (2) Medium gain mode
- (3) Low gain mode

**Fig 10. Noise figure as a function of RF frequency; typical values**

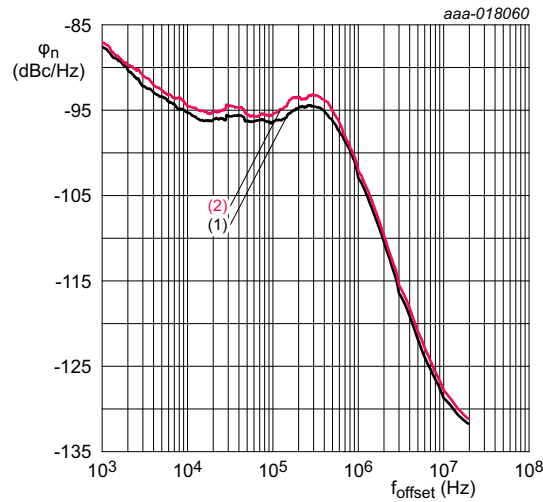

$V_{CC} = 5\text{ V}; T_{amb} = 25\text{ }^\circ\text{C}.$

- (1) Low band
- (2) High band

Fig 11. Phase noise as a function of offset frequency; typical values

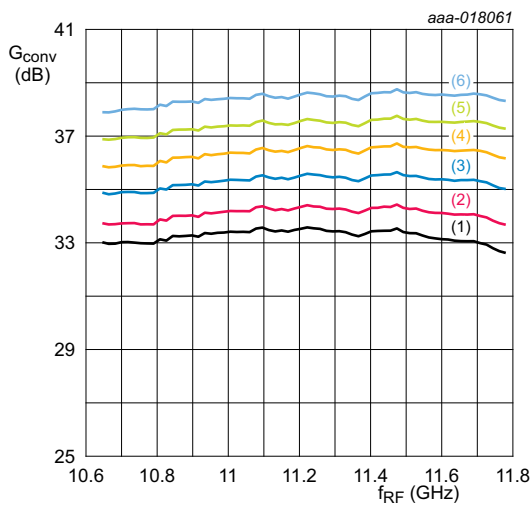

Measured from A\_RF IN to IFOUT1.  
High gain mode; low band;  $V_{CC} = 5\text{ V}.$

- (1)  $T_{amb} = +85\text{ }^\circ\text{C}$
- (2)  $T_{amb} = +60\text{ }^\circ\text{C}$
- (3)  $T_{amb} = +35\text{ }^\circ\text{C}$
- (4)  $T_{amb} = +10\text{ }^\circ\text{C}$
- (5)  $T_{amb} = -15\text{ }^\circ\text{C}$
- (6)  $T_{amb} = -40\text{ }^\circ\text{C}$

Fig 12. Conversion gain as a function of RF frequency; typical values

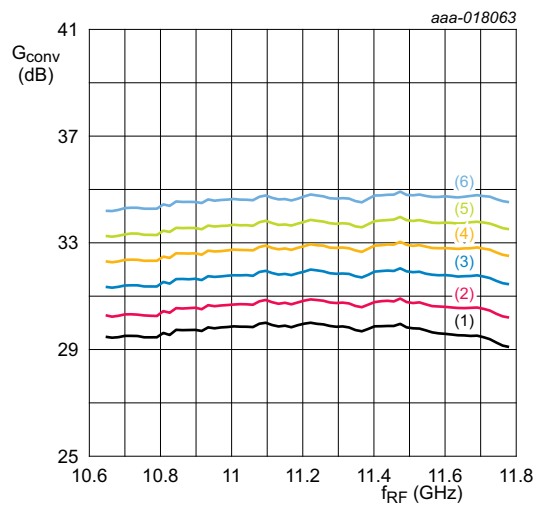

Measured from A\_RF IN to IFOUT1.  
Medium gain mode; low band;  $V_{CC} = 5\text{ V}.$

- (1)  $T_{amb} = +85\text{ }^\circ\text{C}$
- (2)  $T_{amb} = +60\text{ }^\circ\text{C}$
- (3)  $T_{amb} = +35\text{ }^\circ\text{C}$
- (4)  $T_{amb} = +10\text{ }^\circ\text{C}$
- (5)  $T_{amb} = -15\text{ }^\circ\text{C}$
- (6)  $T_{amb} = -40\text{ }^\circ\text{C}$

Fig 13. Conversion gain as a function of RF frequency; typical values

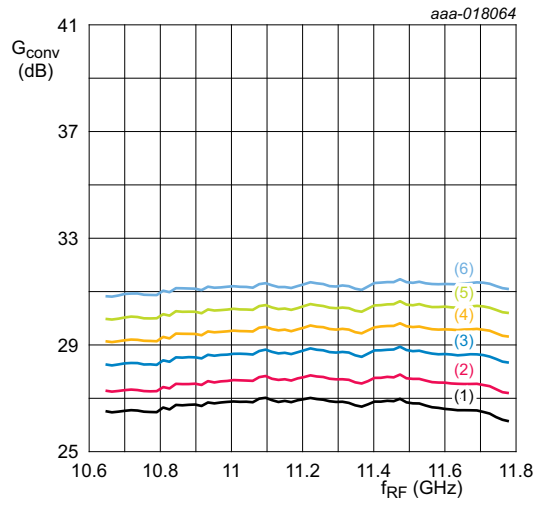

Measured from A\_RF IN to IFOUT1.  
 Low gain mode; low band; V<sub>CC</sub> = 5 V.

- (1) T<sub>amb</sub> = +85 °C
- (2) T<sub>amb</sub> = +60 °C
- (3) T<sub>amb</sub> = +35 °C
- (4) T<sub>amb</sub> = +10 °C
- (5) T<sub>amb</sub> = -15 °C
- (6) T<sub>amb</sub> = -40 °C

**Fig 14. Conversion gain as a function of RF frequency; typical values**

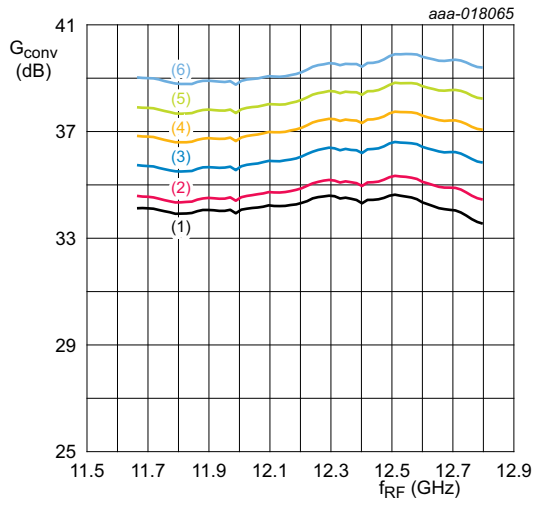

Measured from A\_RFIN to IFOUT1.  
High gain mode; high band;  $V_{CC} = 5\text{ V}$ .

- (1)  $T_{amb} = +85\text{ }^{\circ}\text{C}$
- (2)  $T_{amb} = +60\text{ }^{\circ}\text{C}$
- (3)  $T_{amb} = +35\text{ }^{\circ}\text{C}$
- (4)  $T_{amb} = +10\text{ }^{\circ}\text{C}$
- (5)  $T_{amb} = -15\text{ }^{\circ}\text{C}$
- (6)  $T_{amb} = -40\text{ }^{\circ}\text{C}$

**Fig 15. Conversion gain as a function of RF frequency; typical values**

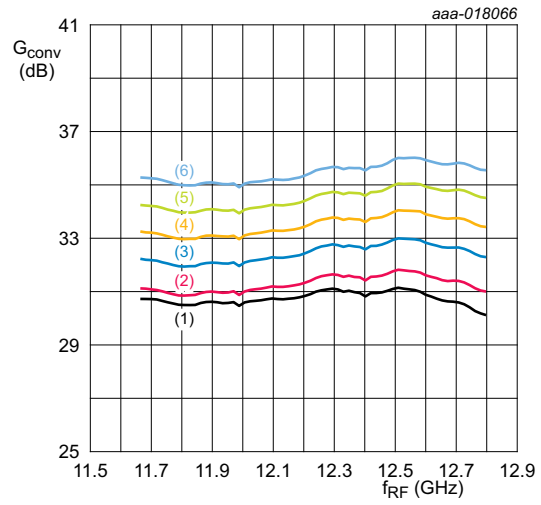

Measured from A\_RFIN to IFOUT1.  
Medium gain mode; high band;  $V_{CC} = 5\text{ V}$ .

- (1)  $T_{amb} = +85\text{ }^{\circ}\text{C}$
- (2)  $T_{amb} = +60\text{ }^{\circ}\text{C}$
- (3)  $T_{amb} = +35\text{ }^{\circ}\text{C}$
- (4)  $T_{amb} = +10\text{ }^{\circ}\text{C}$
- (5)  $T_{amb} = -15\text{ }^{\circ}\text{C}$
- (6)  $T_{amb} = -40\text{ }^{\circ}\text{C}$

**Fig 16. Conversion gain as a function of RF frequency; typical values**

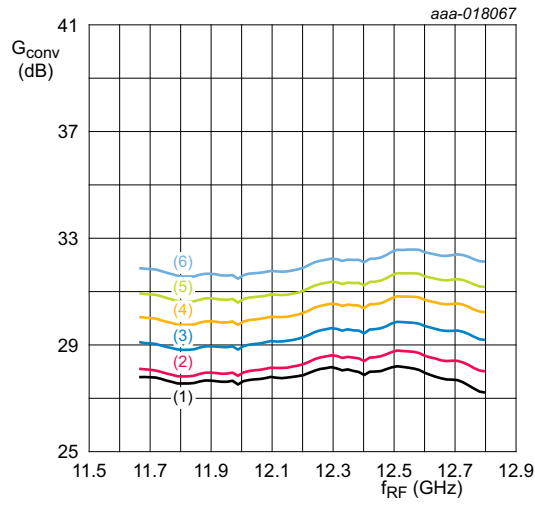

Measured from A\_RF IN to IFOUT1.

Low gain mode; high band; V<sub>CC</sub> = 5 V.

- (1) T<sub>amb</sub> = +85 °C
- (2) T<sub>amb</sub> = +60 °C
- (3) T<sub>amb</sub> = +35 °C
- (4) T<sub>amb</sub> = +10 °C
- (5) T<sub>amb</sub> = -15 °C
- (6) T<sub>amb</sub> = -40 °C

**Fig 17. Conversion gain as a function of RF frequency; typical values**



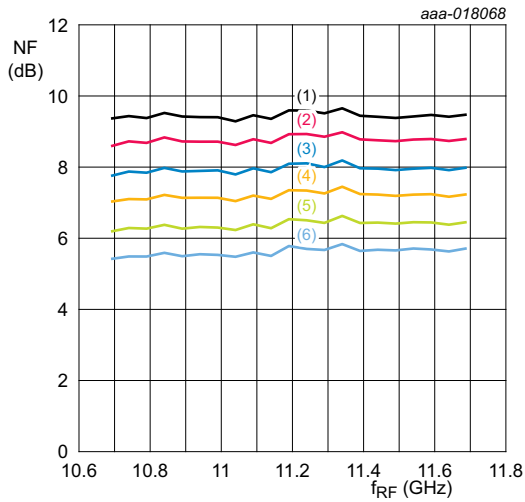

Measured from B\_RF IN to IFOUT1.  
High gain mode; low band; V<sub>CC</sub> = 5 V.

- (1) T<sub>amb</sub> = +85 °C
- (2) T<sub>amb</sub> = +60 °C
- (3) T<sub>amb</sub> = +35 °C
- (4) T<sub>amb</sub> = +10 °C
- (5) T<sub>amb</sub> = -15 °C
- (6) T<sub>amb</sub> = -40 °C

**Fig 18. Noise figure as a function of RF frequency; typical values**

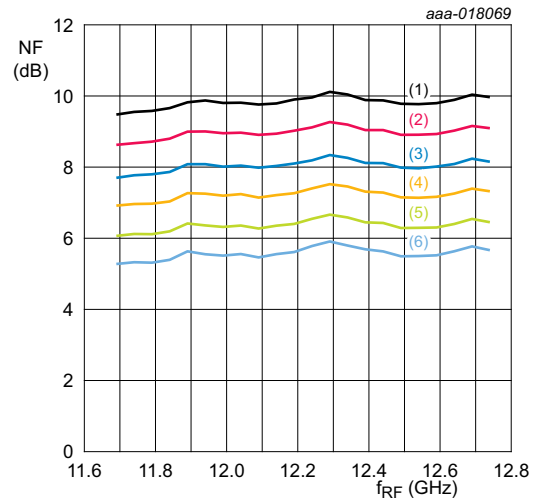

Measured from B\_RF IN to IFOUT1.  
High gain mode; high band; V<sub>CC</sub> = 5 V.

- (1) T<sub>amb</sub> = +85 °C
- (2) T<sub>amb</sub> = +60 °C
- (3) T<sub>amb</sub> = +35 °C
- (4) T<sub>amb</sub> = +10 °C
- (5) T<sub>amb</sub> = -15 °C
- (6) T<sub>amb</sub> = -40 °C

**Fig 19. Noise figure as a function of RF frequency; typical values**

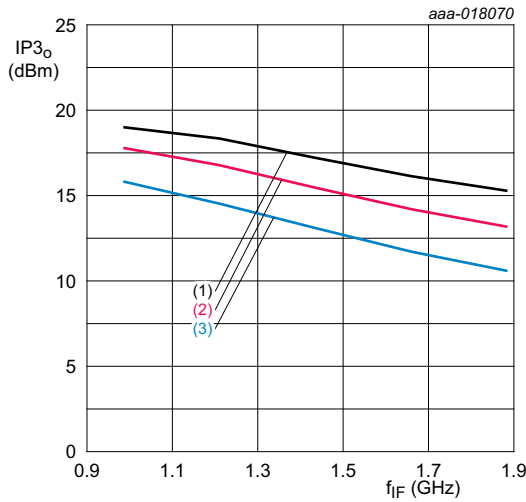

Measured from A\_RF<sub>IN</sub> to IFOUT1.  
 Low band; single activated IF path; V<sub>CC</sub> = 5 V;  
 T<sub>amb</sub> = 25 °C; tone separation = 33 MHz.

- (1) High gain mode
- (2) Medium gain mode
- (3) Low gain mode

**Fig 20. Output third-order intercept point as a function of IF frequency; typical values**

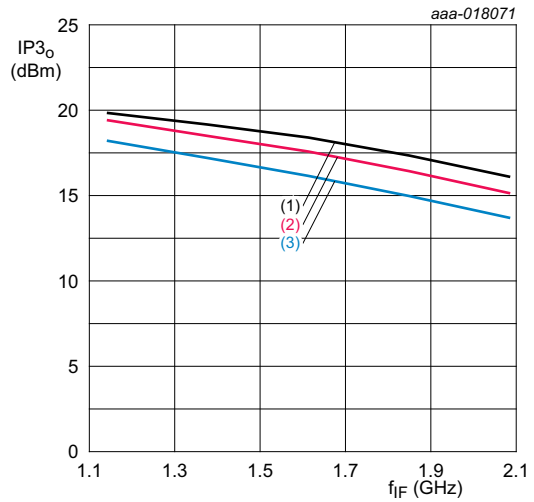

Measured from A\_RF<sub>IN</sub> to IFOUT1.  
 High band; single activated IF path; V<sub>CC</sub> = 5 V;  
 T<sub>amb</sub> = 25 °C; tone separation = 33 MHz.

- (1) High gain mode
- (2) Medium gain mode
- (3) Low gain mode

**Fig 21. Output third-order intercept point as a function of IF frequency; typical values**

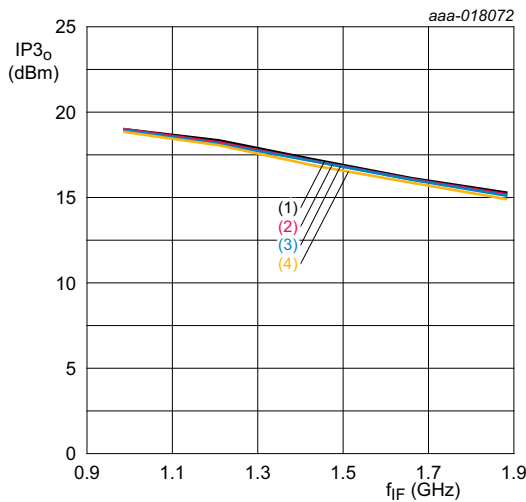

Measured from A\_RF<sub>IN</sub> to IFOUT1.  
 Low band; high gain mode; V<sub>CC</sub> = 5 V; T<sub>amb</sub> = 25 °C;  
 tone separation = 33 MHz.

- (1) 1 activated IF path
- (2) 2 activated IF paths
- (3) 3 activated IF paths
- (4) 4 activated IF paths

**Fig 22. Output third-order intercept point as a function of IF frequency; typical values**

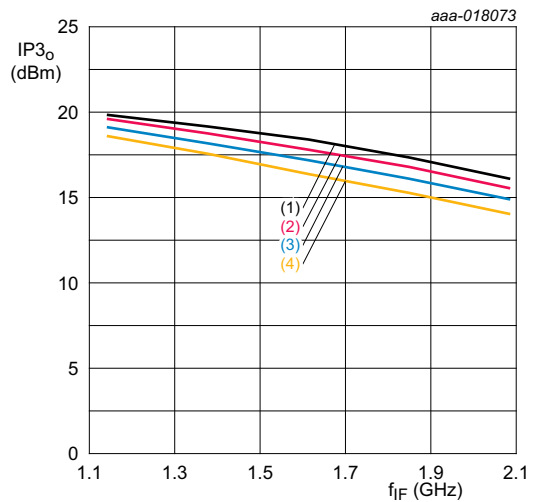

Measured from A\_RF<sub>IN</sub> to IFOUT1.  
 High band; high gain mode; V<sub>CC</sub> = 5 V; T<sub>amb</sub> = 25 °C;  
 tone separation = 33 MHz.

- (1) 1 activated IF path
- (2) 2 activated IF paths
- (3) 3 activated IF paths
- (4) 4 activated IF paths

**Fig 23. Output third-order intercept point as a function of IF frequency; typical values**

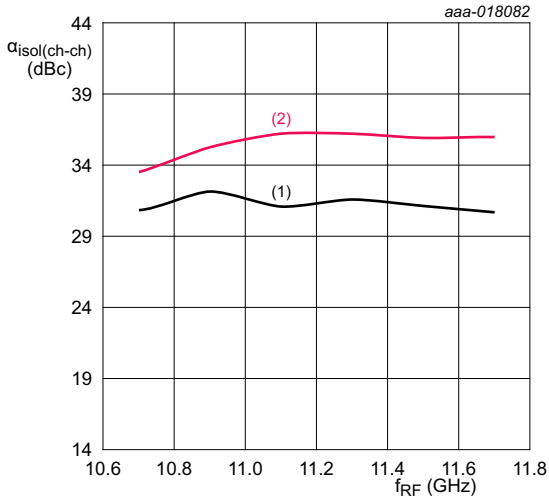

Low band; high gain mode;  $V_{CC} = 5\text{ V}$ ;  $T_{amb} = 25\text{ }^\circ\text{C}$ .  
 (1) RF input path B to RF input path A  
 (2) RF input path A to RF input path B

**Fig 24. Isolation between channels as a function of RF frequency; typical values**

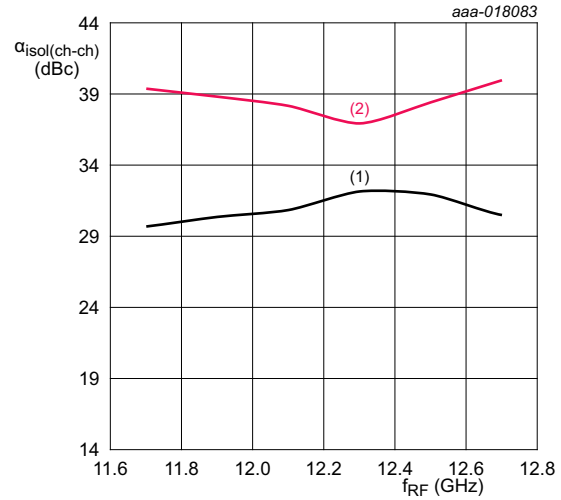

High band; high gain mode;  $V_{CC} = 5\text{ V}$ ;  $T_{amb} = 25\text{ }^\circ\text{C}$ .  
 (1) RF input path B to RF input path A  
 (2) RF input path A to RF input path B

**Fig 25. Isolation between channels as a function of RF frequency; typical values**

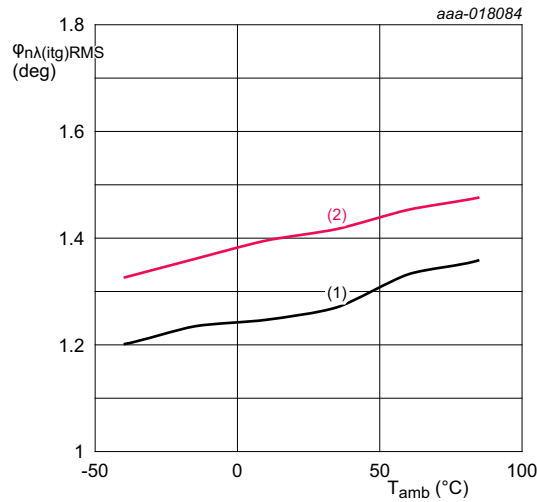

$V_{CC} = 5\text{ V}$ .  
 (1) Low band  
 (2) High band

**Fig 26. RMS integrated phase noise density as a function of ambient temperature; typical values**

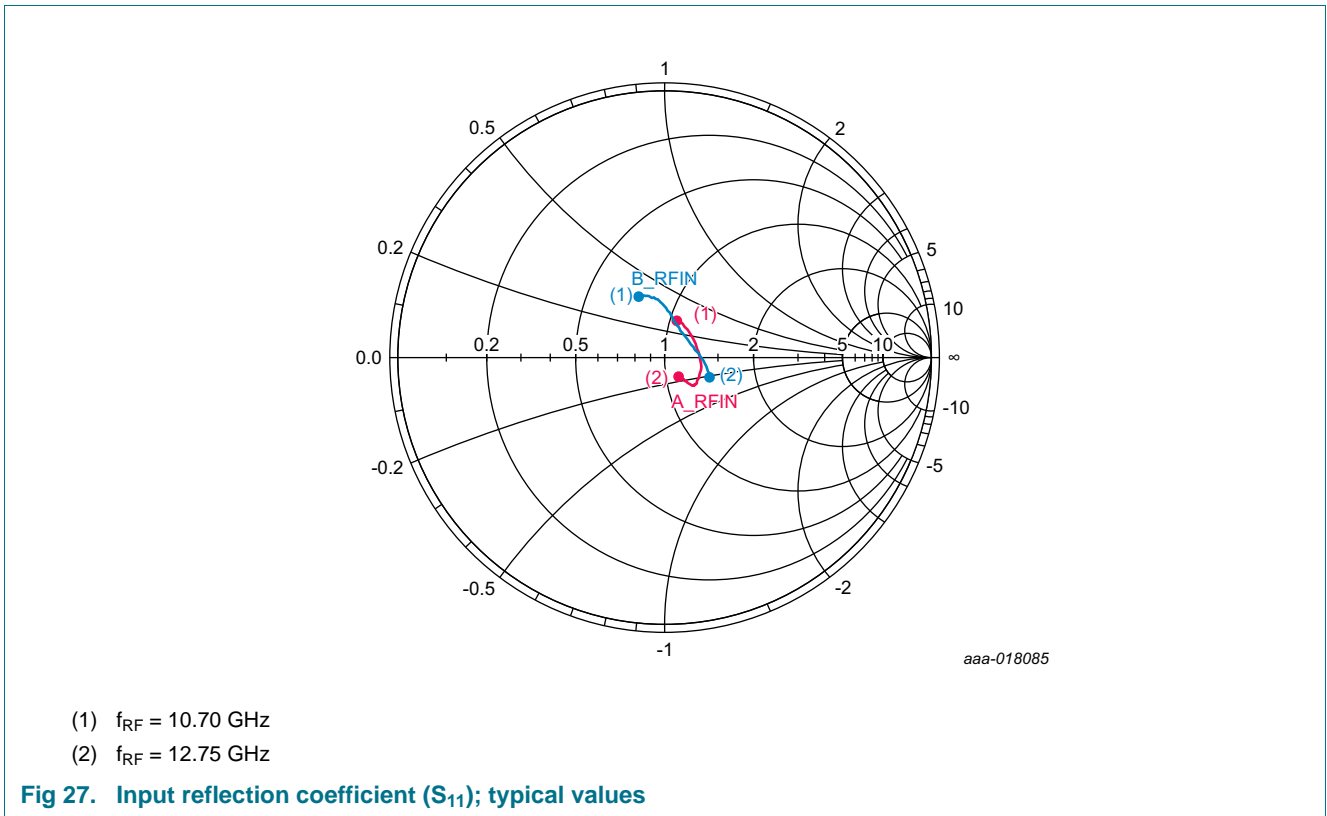

14. Application information

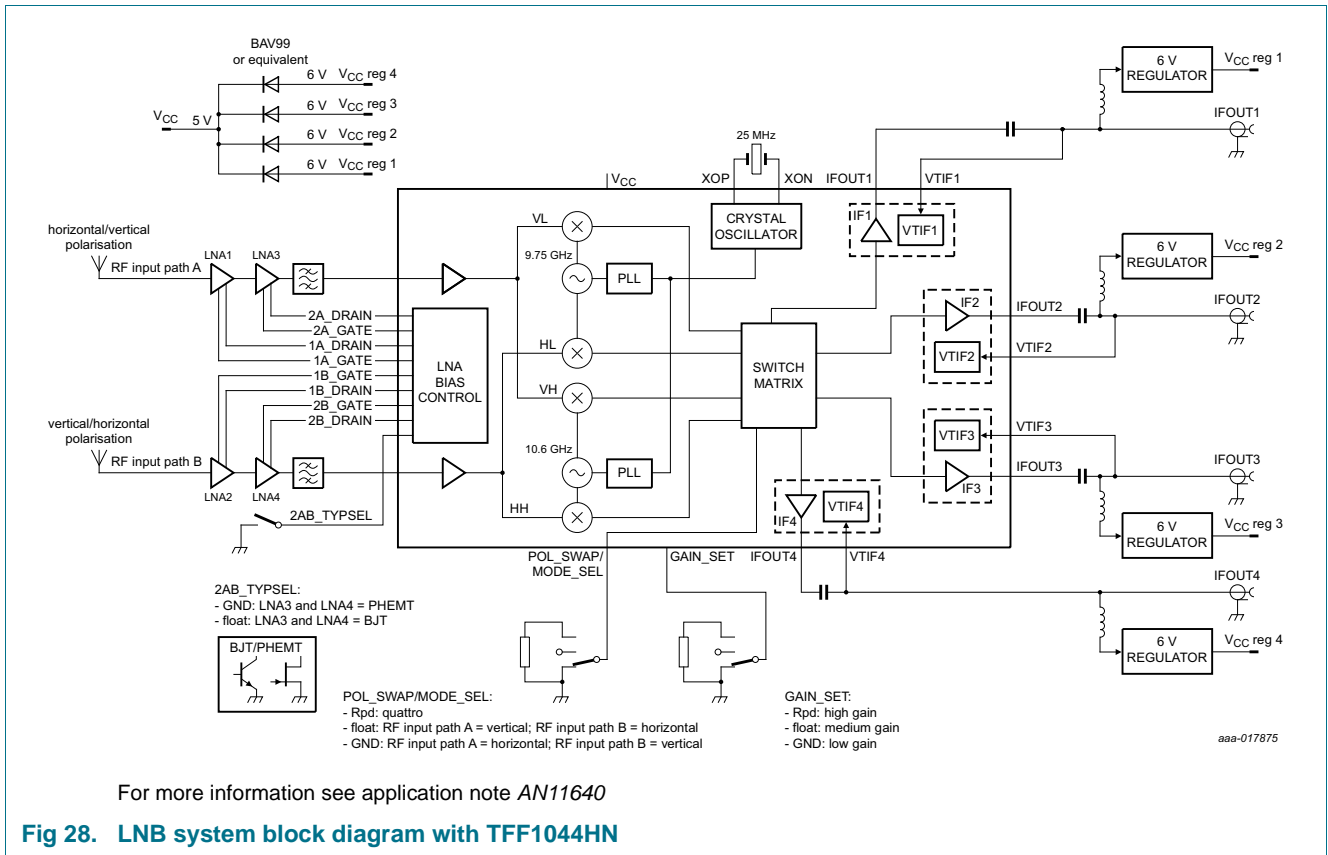
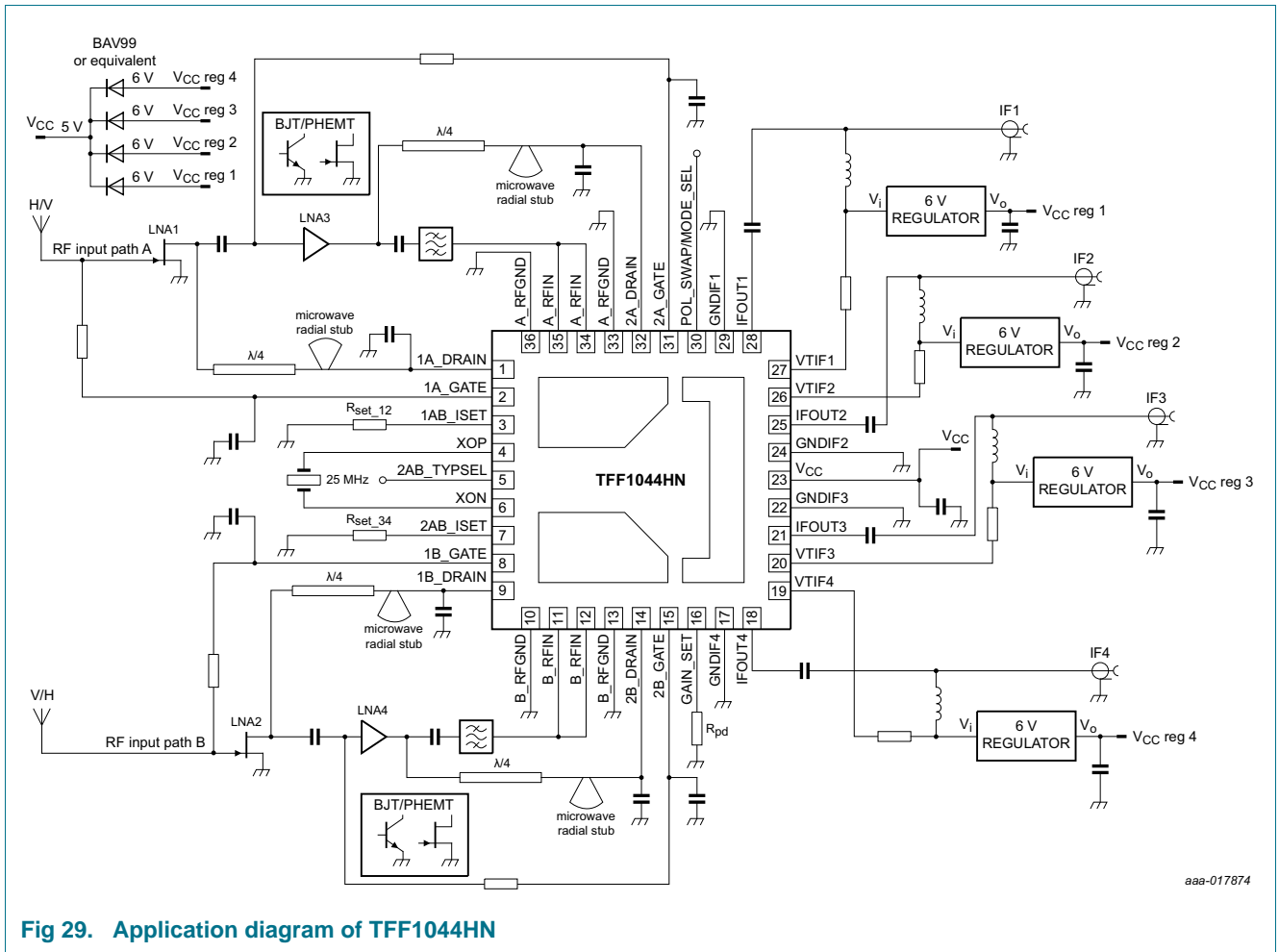

Fig 28. LNB system block diagram with TFF1044HN



aaa-017874

Fig 29. Application diagram of TFF1044HN

15. Package outline

HVLGA36: plastic thermal enhanced very thin profile land grid array package; no leads; 36 terminals;

SOT1359-1

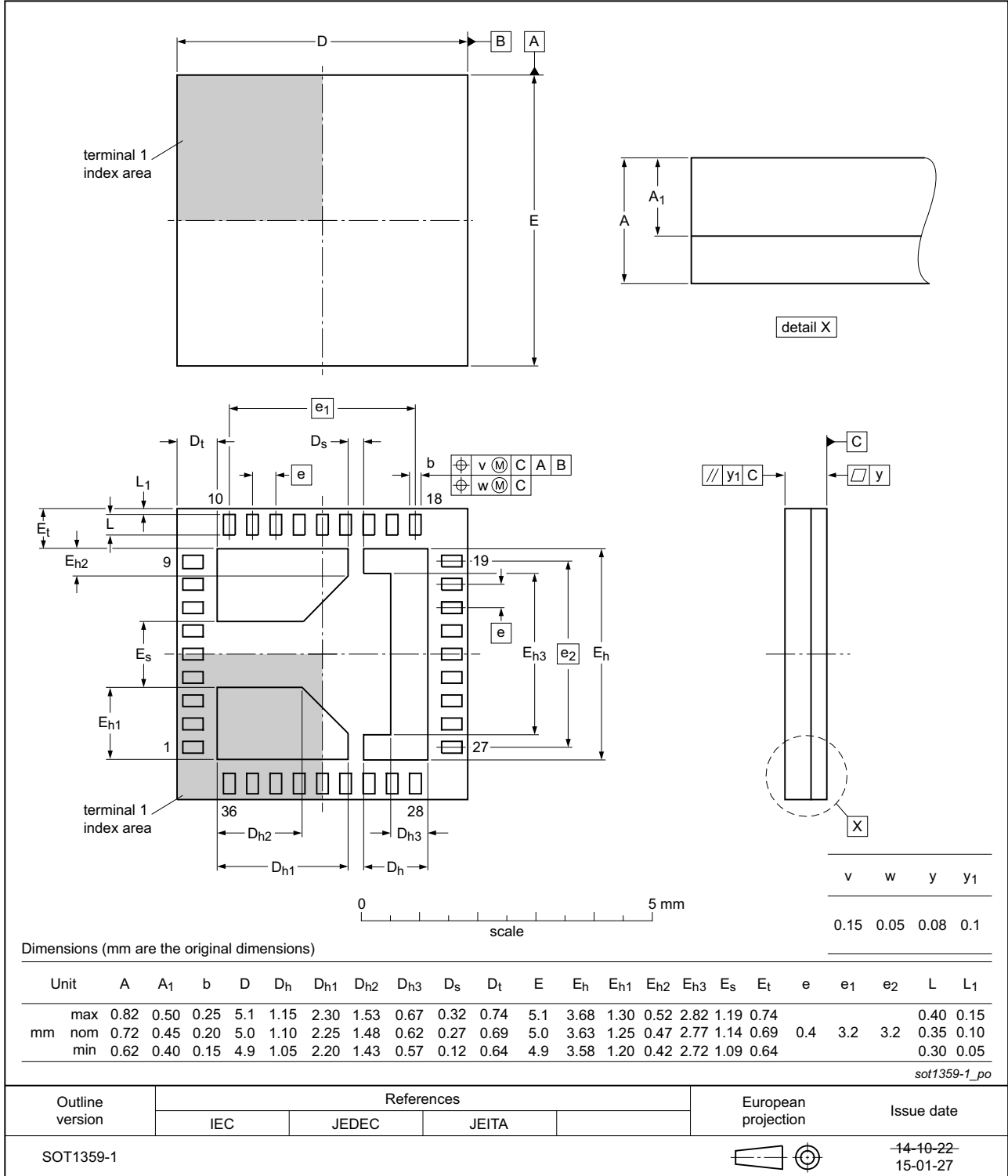

Fig 30. Package outline SOT1359-1 (HVLGA36)

## 16. Abbreviations

Table 14. Abbreviations

Acronym	Description
BJT	Bipolar Junction Transistor
HH	Horizontal High band
HL	Horizontal Low band
IF	Intermediate Frequency
IP	Internet Protocol
K <sub>u</sub> band	K-under band
LNA	Low Noise Amplifier
LNB	Low Noise Block
LO	Local Oscillator
pHEMT	pseudomorphic High Electron Mobility Transistor
PLL	Phase-Locked Loop
RBW	Resolution BandWidth
VH	Vertical High band
VL	Vertical Low band
VT	Voltage Tone

## 17. Revision history

Table 15. Revision history

Document ID	Release date	Data sheet status	Change notice	Supersedes
TFF1044HN v.1	20150610	Product data sheet	-	-



## 18. Legal information

### 18.1 Data sheet status

Document status <sup>[1][2]</sup>	Product status <sup>[3]</sup>	Definition
Objective [short] data sheet	Development	This document contains data from the objective specification for product development.
Preliminary [short] data sheet	Qualification	This document contains data from the preliminary specification.
Product [short] data sheet	Production	This document contains the product specification.

[1] Please consult the most recently issued document before initiating or completing a design.

[2] The term 'short data sheet' is explained in section "Definitions".

[3] The product status of device(s) described in this document may have changed since this document was published and may differ in case of multiple devices. The latest product status information is available on the Internet at URL <http://www.nxp.com>.

### 18.2 Definitions

**Draft** — The document is a draft version only. The content is still under internal review and subject to formal approval, which may result in modifications or additions. NXP Semiconductors does not give any representations or warranties as to the accuracy or completeness of information included herein and shall have no liability for the consequences of use of such information.

**Short data sheet** — A short data sheet is an extract from a full data sheet with the same product type number(s) and title. A short data sheet is intended for quick reference only and should not be relied upon to contain detailed and full information. For detailed and full information see the relevant full data sheet, which is available on request via the local NXP Semiconductors sales office. In case of any inconsistency or conflict with the short data sheet, the full data sheet shall prevail.

**Product specification** — The information and data provided in a Product data sheet shall define the specification of the product as agreed between NXP Semiconductors and its customer, unless NXP Semiconductors and customer have explicitly agreed otherwise in writing. In no event however, shall an agreement be valid in which the NXP Semiconductors product is deemed to offer functions and qualities beyond those described in the Product data sheet.

### 18.3 Disclaimers

**Limited warranty and liability** — Information in this document is believed to be accurate and reliable. However, NXP Semiconductors does not give any representations or warranties, expressed or implied, as to the accuracy or completeness of such information and shall have no liability for the consequences of use of such information. NXP Semiconductors takes no responsibility for the content in this document if provided by an information source outside of NXP Semiconductors.

In no event shall NXP Semiconductors be liable for any indirect, incidental, punitive, special or consequential damages (including - without limitation - lost profits, lost savings, business interruption, costs related to the removal or replacement of any products or rework charges) whether or not such damages are based on tort (including negligence), warranty, breach of contract or any other legal theory.

Notwithstanding any damages that customer might incur for any reason whatsoever, NXP Semiconductors' aggregate and cumulative liability towards customer for the products described herein shall be limited in accordance with the *Terms and conditions of commercial sale* of NXP Semiconductors.

**Right to make changes** — NXP Semiconductors reserves the right to make changes to information published in this document, including without limitation specifications and product descriptions, at any time and without notice. This document supersedes and replaces all information supplied prior to the publication hereof.

**Suitability for use** — NXP Semiconductors products are not designed, authorized or warranted to be suitable for use in life support, life-critical or safety-critical systems or equipment, nor in applications where failure or malfunction of an NXP Semiconductors product can reasonably be expected to result in personal injury, death or severe property or environmental damage. NXP Semiconductors and its suppliers accept no liability for inclusion and/or use of NXP Semiconductors products in such equipment or applications and therefore such inclusion and/or use is at the customer's own risk.

**Applications** — Applications that are described herein for any of these products are for illustrative purposes only. NXP Semiconductors makes no representation or warranty that such applications will be suitable for the specified use without further testing or modification.

Customers are responsible for the design and operation of their applications and products using NXP Semiconductors products, and NXP Semiconductors accepts no liability for any assistance with applications or customer product design. It is customer's sole responsibility to determine whether the NXP Semiconductors product is suitable and fit for the customer's applications and products planned, as well as for the planned application and use of customer's third party customer(s). Customers should provide appropriate design and operating safeguards to minimize the risks associated with their applications and products.

NXP Semiconductors does not accept any liability related to any default, damage, costs or problem which is based on any weakness or default in the customer's applications or products, or the application or use by customer's third party customer(s). Customer is responsible for doing all necessary testing for the customer's applications and products using NXP Semiconductors products in order to avoid a default of the applications and the products or of the application or use by customer's third party customer(s). NXP does not accept any liability in this respect.

**Limiting values** — Stress above one or more limiting values (as defined in the Absolute Maximum Ratings System of IEC 60134) will cause permanent damage to the device. Limiting values are stress ratings only and (proper) operation of the device at these or any other conditions above those given in the Recommended operating conditions section (if present) or the Characteristics sections of this document is not warranted. Constant or repeated exposure to limiting values will permanently and irreversibly affect the quality and reliability of the device.

**Terms and conditions of commercial sale** — NXP Semiconductors products are sold subject to the general terms and conditions of commercial sale, as published at <http://www.nxp.com/profile/terms>, unless otherwise agreed in a valid written individual agreement. In case an individual agreement is concluded only the terms and conditions of the respective agreement shall apply. NXP Semiconductors hereby expressly objects to applying the customer's general terms and conditions with regard to the purchase of NXP Semiconductors products by customer.

**No offer to sell or license** — Nothing in this document may be interpreted or construed as an offer to sell products that is open for acceptance or the grant, conveyance or implication of any license under any copyrights, patents or other industrial or intellectual property rights.

**Export control** — This document as well as the item(s) described herein may be subject to export control regulations. Export might require a prior authorization from competent authorities.

**Non-automotive qualified products** — Unless this data sheet expressly states that this specific NXP Semiconductors product is automotive qualified, the product is not suitable for automotive use. It is neither qualified nor tested in accordance with automotive testing or application requirements. NXP Semiconductors accepts no liability for inclusion and/or use of non-automotive qualified products in automotive equipment or applications.

In the event that customer uses the product for design-in and use in automotive applications to automotive specifications and standards, customer (a) shall use the product without NXP Semiconductors' warranty of the product for such automotive applications, use and specifications, and (b) whenever customer uses the product for automotive applications beyond NXP Semiconductors' specifications such use shall be solely at customer's own risk, and (c) customer fully indemnifies NXP Semiconductors for any

liability, damages or failed product claims resulting from customer design and use of the product for automotive applications beyond NXP Semiconductors' standard warranty and NXP Semiconductors' product specifications.

**Quick reference data** — The Quick reference data is an extract of the product data given in the Limiting values and Characteristics sections of this document, and as such is not complete, exhaustive or legally binding.

**Translations** — A non-English (translated) version of a document is for reference only. The English version shall prevail in case of any discrepancy between the translated and English versions.

## 18.4 Trademarks

Notice: All referenced brands, product names, service names and trademarks are the property of their respective owners.

## 19. Contact information

For more information, please visit: <http://www.nxp.com>

For sales office addresses, please send an email to: [salesaddresses@nxp.com](mailto:salesaddresses@nxp.com)

## 20. Contents

<b>1</b>	<b>General description</b> .....	<b>1</b>
<b>2</b>	<b>Features and benefits</b> .....	<b>1</b>
<b>3</b>	<b>Applications</b> .....	<b>1</b>
<b>4</b>	<b>Quick reference data</b> .....	<b>2</b>
<b>5</b>	<b>Ordering information</b> .....	<b>2</b>
<b>6</b>	<b>Functional diagram</b> .....	<b>3</b>
<b>7</b>	<b>Pinning information</b> .....	<b>4</b>
7.1	Pinning .....	4
7.2	Pin description .....	4
<b>8</b>	<b>Limiting values</b> .....	<b>5</b>
<b>9</b>	<b>Recommended operating conditions</b> .....	<b>6</b>
<b>10</b>	<b>Thermal characteristics</b> .....	<b>6</b>
<b>11</b>	<b>Characteristics</b> .....	<b>7</b>
11.1	Impedance information .....	9
<b>12</b>	<b>Modes of operation</b> .....	<b>9</b>
12.1	IF on/off and band/polarization control logic ...	9
12.2	RF path assignment logic .....	9
12.2.1	Quattro mode .....	10
12.3	Conversion gain selection logic .....	10
12.4	LNA selection logic .....	10
<b>13</b>	<b>Graphs</b> .....	<b>11</b>
<b>14</b>	<b>Application information</b> .....	<b>21</b>
<b>15</b>	<b>Package outline</b> .....	<b>23</b>
<b>16</b>	<b>Abbreviations</b> .....	<b>24</b>
<b>17</b>	<b>Revision history</b> .....	<b>24</b>
<b>18</b>	<b>Legal information</b> .....	<b>25</b>
18.1	Data sheet status .....	25
18.2	Definitions .....	25
18.3	Disclaimers .....	25
18.4	Trademarks .....	26
<b>19</b>	<b>Contact information</b> .....	<b>26</b>
<b>20</b>	<b>Contents</b> .....	<b>27</b>

Please be aware that important notices concerning this document and the product(s) described herein, have been included in section 'Legal information'.

© NXP Semiconductors N.V. 2015.

All rights reserved.

For more information, please visit: <http://www.nxp.com>

For sales office addresses, please send an email to: [salesaddresses@nxp.com](mailto:salesaddresses@nxp.com)

Date of release: 10 June 2015

Document identifier: TFF1044HN