



**Inolux 5mm Full-Color Through Hole Lamp  
HV-5RGBXX Series**

Official Product	HV-5RGBXX series	Customer Part No.	Data Sheet No.
	*****	*****	HV-5RGBXX series
Specifications are subject to change without notice. Data and drawings herein are copyrighted.	May 14, 2019	Version of 1.2	Page 1/11

## DISCLAIMER

INOLUX reserves the right to make changes without further notice to any products herein to improve reliability, function or design. INOLUX does not assume any liability arising out of the application or use of any product or circuit described herein; neither does it convey any license under its patent rights, nor the rights of others.

## LIFE SUPPORT POLICY

INOLUX's products are not authorized for use as critical components in life support devices or systems without the express written approval of the President of INOLUX or INOLUX INTERNATIONAL. As used herein:

1. Life support devices or systems are devices or systems which, (a) are intended for surgical implant into the body, or (b) support or sustain life, and (c) whose failure to perform when properly used in accordance with instructions for use provided in the labeling, can be reasonably expected to result in a significant injury of the user.
  
2. A critical component in any component of a life support device or system whose failure to perform can be reasonably expected to cause the failure of the life support device or system, or to affect its safety or effectiveness.

Official Product	HV-5RGBXX series	Customer Part No.		Data Sheet No.
	*****	*****		HV-5RGBXX series
Specifications are subject to change without notice. Data and drawings herein are copyrighted.		May 14, 2019	Version of 1.2	Page 2/11

**Orderable Information**

**H V - 5 R G B X X - Y Y Y Y**



Series Name	Color Code	Viewing Angle	Customer Code
<b>HV=</b> Inolux Through Hole Lamp	<b>RGB=</b> 632nm AlInGaP Red 520nm InGaN Green 470nm InGaN Blue	<b>25=</b> 25° <b>60=</b> 60°	<b>YYYY =</b> Customer code

Official Product	HV-5RGBXX series	Customer Part No.	Data Sheet No.
	*****	*****	HV-5RGBXX series
Specifications are subject to change without notice. Data and drawings herein are copyrighted.		May 14, 2019	Version of 1.2
			Page 3/11

**Features:**

- Full-Color
- Popular 5mm through hole package
- White Clear Lens
- AllnGaP/InGaN technology
- Solid state reliability
- Special packaging available upon request

**Dimensions for HV-5RGB25**

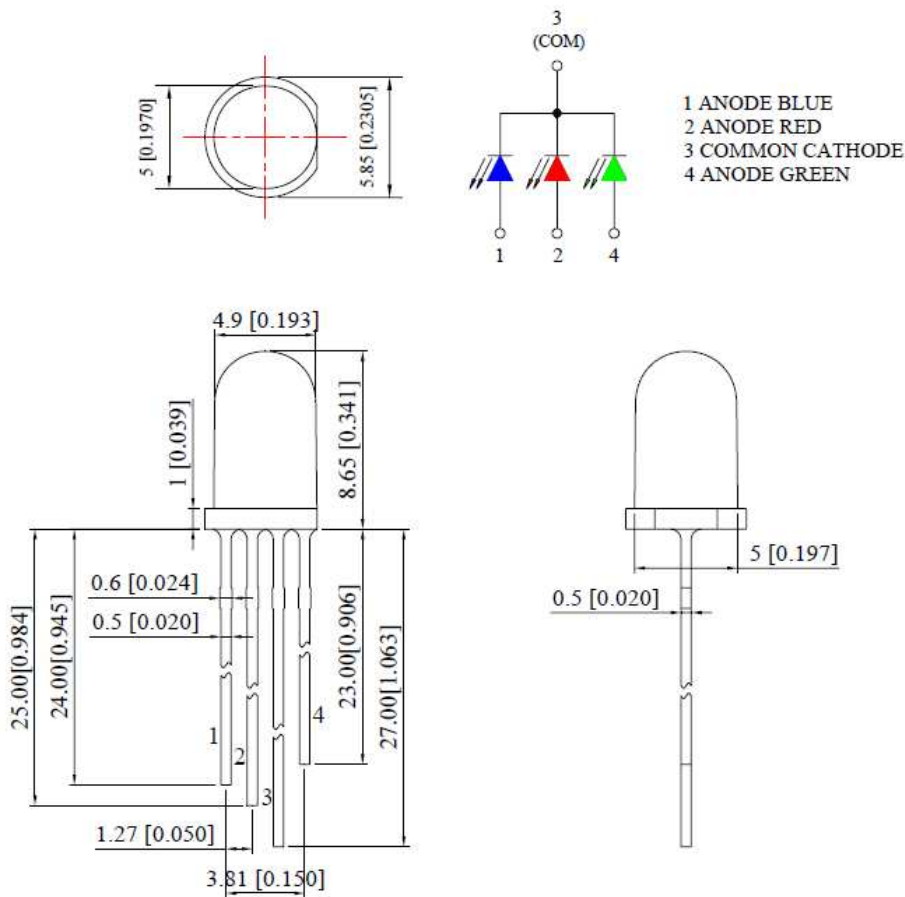

-All Dimensions are in millimeters

-Tolerance = +/- 0.25mm

Official Product	HV-5RGBXX series	Customer Part No.	Data Sheet No.
	*****	*****	HV-5RGBXX series
Specifications are subject to change without notice. Data and drawings herein are copyrighted.		May 14, 2019	Version of 1.2
			Page 4/11

**Dimensions for HV-5RGB60**

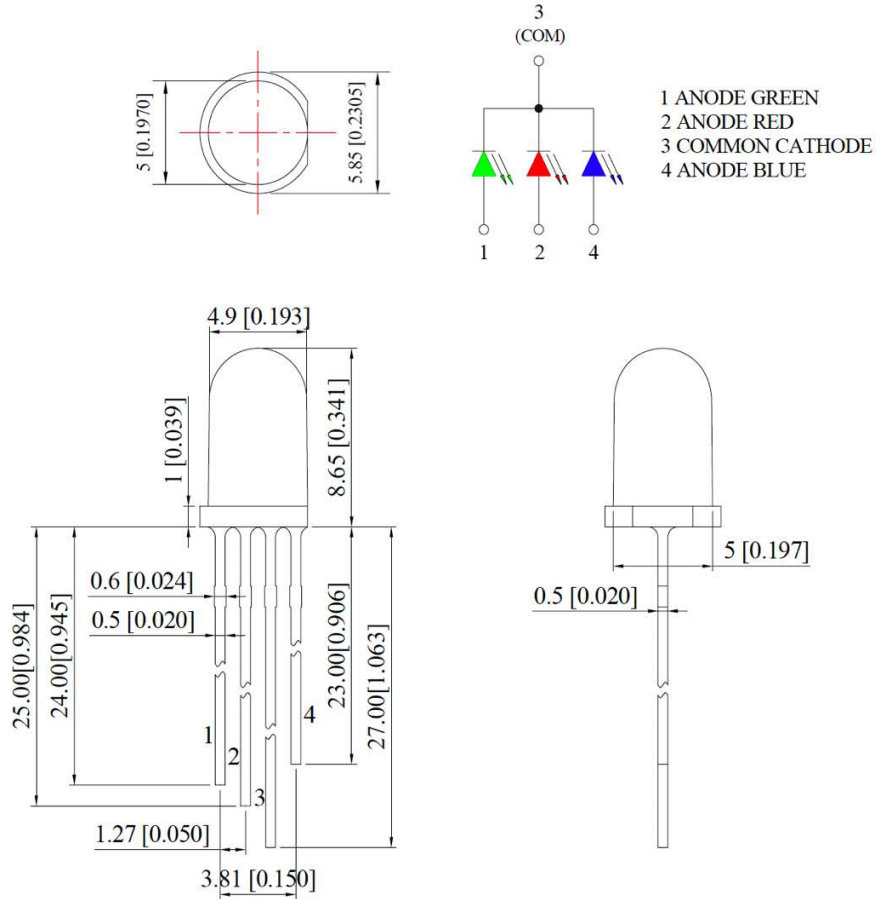

-All Dimensions are in millimeters

-Tolerance = +/- 0.25mm

Official Product	HV-5RGBXX series	Customer Part No.	Data Sheet No.
	*****	*****	HV-5RGBXX series
Specifications are subject to change without notice. Data and drawings herein are copyrighted.	May 14, 2019	Version of 1.2	Page 5/11

**Absolute Maximum Ratings at Ta=25C**

Parameter	Symbol	AllnGaP	InGaN	Unit
Power Dissipation	$P_d$	65	95	mW
Reverse Voltage	$V_r$	5		V
Forward Current	$I_F$	25		mA
Reverse Current	$I_r$	10		$\mu$ A
Peak Current ( 1/10 Duty Cycle, 0.1ms pulse width )	$I_F$ (Peak)	100		mA
Operating Temperature Range	$T_{opr}$	-40 to +80		$^{\circ}$ C
Storage Temperature Range	$T_{stg}$	-40 to +100		$^{\circ}$ C
Lead Soldering Temp	$T_{sol}$	260		$^{\circ}$ C

Official Product	HV-5RGBXX series	Customer Part No.		Data Sheet No.
	*****	*****		HV-5RGBXX series
Specifications are subject to change without notice. Data and drawings herein are copyrighted.		May 14, 2019	Version of 1.2	Page 6/11

**Electrical and Optical Characteristic ( @ 25 degree C )**

<b>Parameter</b>	<b>R</b>	<b>G</b>	<b>B</b>	<b>Test Condition</b>
Luminous Intensity:				
Min (mcd)	1600	2000	1000	If=20mA
Typ (mcd)	3200	4000	2000	If=20mA
Forward voltage (Vf)				
Typ	2.0	3.4	3.4	If=20mA
Max	2.6	3.8	3.8	If=20mA
Dominant Wavelength (nm)	624	525	470	If=20mA
Viewing Angle (Deg)	25	25	25	If=20mA

<b>Parameter</b>	<b>R</b>	<b>G</b>	<b>B</b>	<b>Test Condition</b>
Luminous Intensity:				
Min (mcd)	350	450	250	If=20mA
Typ (mcd)	600	1000	500	If=20mA
Forward voltage (Vf)				
Typ	2.0	3.4	3.4	If=20mA
Max	2.6	3.8	3.8	If=20mA
Dominant Wavelength (nm)	624	525	470	If=20mA
Viewing Angle (Deg)	60	60	60	If=20mA

▪ Brightness tolerance = +/- 10%

Official Product	HV-5RGBXX series	Customer Part No.		Data Sheet No.
	*****	*****		HV-5RGBXX series
Specifications are subject to change without notice. Data and drawings herein are copyrighted.		May 14, 2019	Version of 1.2	Page 7/11

**Characteristic Curves for Red (R)**

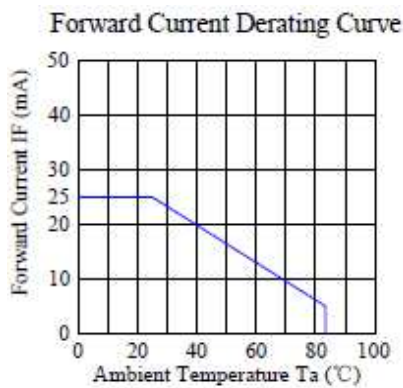
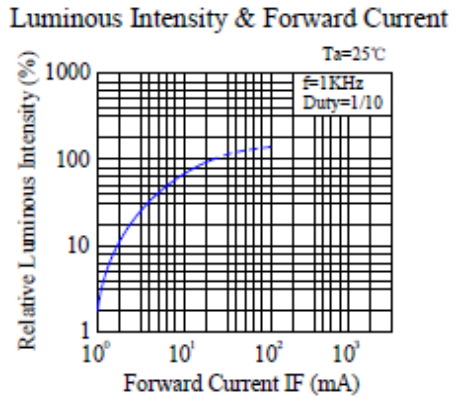
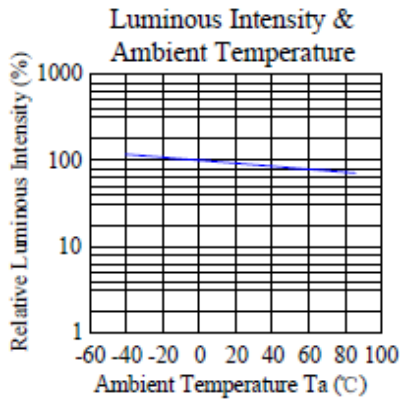
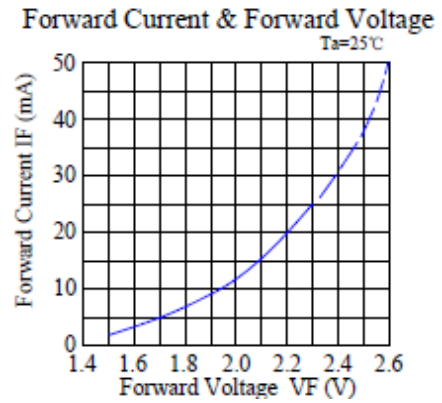
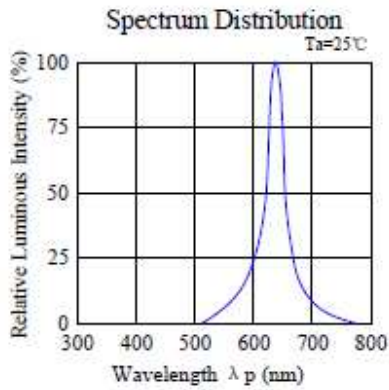

Official Product	HV-5RGBXX series	Customer Part No.	Data Sheet No.
	*****	*****	HV-5RGBXX series
Specifications are subject to change without notice. Data and drawings herein are copyrighted.		May 14, 2019	Version of 1.2
			Page 8/11



**Characteristic Curves for Green (G) and Blue (B)**

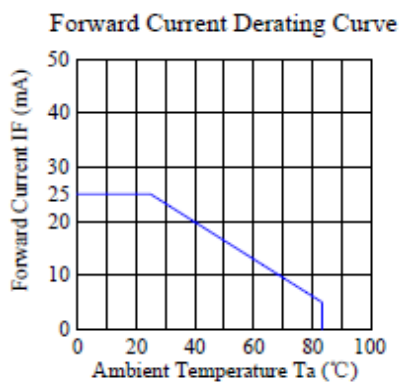
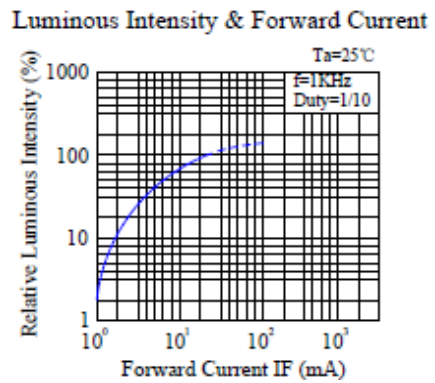
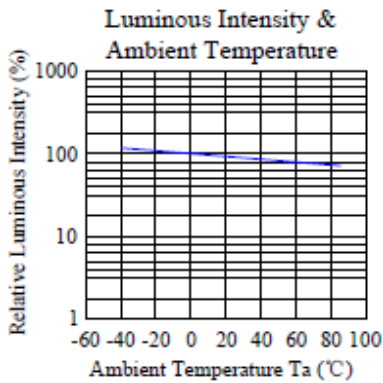
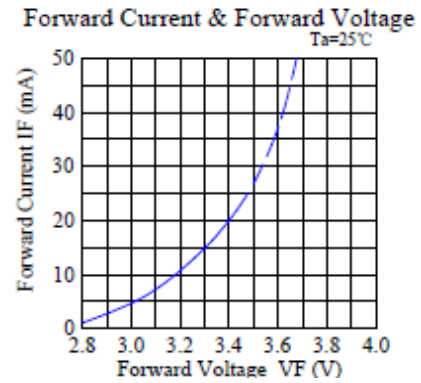
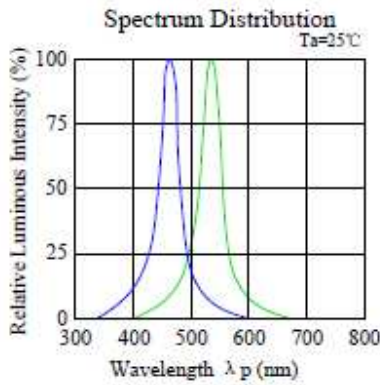

Official Product	HV-5RGBXX series	Customer Part No.	Data Sheet No.
	*****	*****	HV-5RGBXX series
Specifications are subject to change without notice. Data and drawings herein are copyrighted.		May 14, 2019	Version of 1.2
			Page 9/11

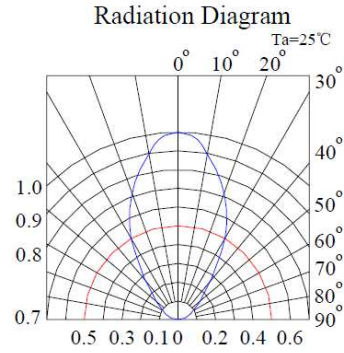
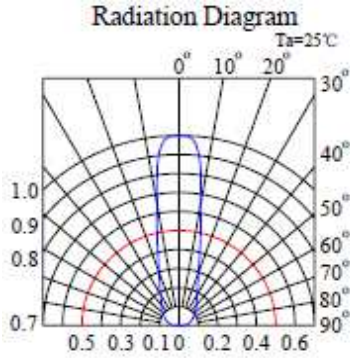
**Radiation Diagram**

Official Product	HV-5RGBXX series	Customer Part No.	Data Sheet No.
	*****	*****	HV-5RGBXX series
Specifications are subject to change without notice. Data and drawings herein are copyrighted.		May 14, 2019	Version of 1.2
			Page 10/11



**Revision History**

<b>Changes since last revision</b>	<b>Page</b>	<b>Version No.</b>	<b>Revision Date</b>
Initial release for 5mm Full-Color Lamp		1.0	06-27-2013
Update HV-5RGB60 Dimension		1.1	07-21-2015
Update the Lens Spec.		1.2	05-14-2019

Official Product	HV-5RGBXX series	Customer Part No.	Data Sheet No.
	*****	*****	HV-5RGBXX series
Specifications are subject to change without notice. Data and drawings herein are copyrighted.	May 14, 2019	Version of 1.2	Page 11/11