



M2MBoxPro - INDUSTRIAL GATEWAY

USER MANUAL REV0.2

WWW.MAESTRO-WIRELESS.COM

EMAIL: CONTACT@MAESTRO-WIRELESS.COM

TEL: 852 2869 0688

FAX: 852 2525 4701

ADDRESS: ROOM 3603-3609, 36/F, 118 CONNAUGHT ROAD WEST, SHEUNG WAN, HONG KONG

Revision history

Rev.	Date	Details	Originated by
0.1	24 June 2010	First issue	Pierre-Emmanuel Surga
0.2	05 August 2010	I ² C interface details, regulatory details	Pierre-Emmanuel Surga

This manual is written without any warranty.

Maestro Wireless Solutions Ltd. reserves the right to modify or improve the product and its accessories which can also be withdrawn without prior notice.

Besides, our company stresses the fact that the performance of the product as well as accessories depends not only on the proper conditions of use, but also on the environment around the places of use.

Maestro Wireless Solutions Ltd. assumes no liability for damage incurred directly or indirectly from errors, omissions or discrepancies between the modem and the manual.

Contents

1	Description	5
1.1	Package	5
1.2	Interfaces	5
1.2.1	Serial port 1	6
1.2.2	Serial port 2	7
1.2.3	Ethernet	7
1.2.4	Audio	8
1.2.5	USB console	8
1.2.6	Power input	8
1.2.7	Battery	9
1.2.8	Digital inputs	9
1.2.9	I ² C port	9
1.2.10	Analog Inputs	10
1.2.11	Digital Outputs	10
1.2.12	LEDs and buttons	11
1.2.13	Battery slot	11
1.2.14	SIM holder	11
1.2.15	Hardware configuration DIP switches	11
2	Installation	13
2.1	Inserting SIM card and battery	13
2.2	Mounting the M2MBoxPro	13
2.3	Connect the external antenna (SMA type)	13
2.4	Connect the modem to external device	14
2.5	Connect the DC power supply	14

Safety precautions

General precautions

- The modem generates radio frequency (RF) power. When using the modem care must be taken on safety issues related to RF interference as well as regulations of RF equipment.
- Do not use your phone in aircraft, hospitals, petrol stations or in places where using GSM products is prohibited.
- Be sure that the modem will not be interfering with nearby equipment. For example: pacemakers or medical equipment. The antenna of the modem should be away from computers, office equipment, home appliance, etc.
- An external antenna must be connected to the modem for proper operation. Only used approved antennas with the modem. Please contact authorized dealer on finding an approved antenna.
- Always keep the antenna with minimum safety distance of 26.6 cm or more

Protecting your modem

- To ensure error-free usage, please install and operate your modem with care. Do remember the following:
- Do not expose the modem to extreme conditions such as high humidity/rain, high temperatures, direct sunlight, caustic/harsh chemicals, dust, or water.
- Do not try to disassemble or modify the modem. There is no user serviceable part inside and the warranty would be void.
- Do not drop, hit or shake the modem. Do not use the modem under extreme vibrating condition.
- Do not pull the antenna or power supply cable. Attach/ detach by holding the connector.
- Connect the modem only according to the instruction manual. Failure to do it will void the warranty.

Chapter 1

Description

The M2MBoxPro is a ready-to-use industrial gateway for voice, data, fax and SMS services. It also supports cellular connectivity (GSM, GPRS) as well as Ethernet, serial ports, USB and various industrial interfaces. The M2MBoxPro can be easily controlled by using AT command for all kinds of operations. It is also fully customizable using the Sierra Wireless openAT operating system and development environment to fit various customer applications.

1.1 Package

The M2MBoxPro package should include the following:

- M2MBoxPro x 1
- Power cord with fuse x 1
- Terminal block connectors x 5
- RS232 serial cable x1
- L-shape antenna (linear quad band antenna) x1 ¹

1.2 Interfaces

¹The provided antenna has a gain of $2.0 \pm 0.7\text{dBi}$ @ 880 MHz and $1.0 \pm 0.7\text{dBi}$ @ 1990 MHz. As per FCC requirements no antenna of a greater gain should be used with the M2MBoxPro. In addition, it is required to always keep a safety distance of 26.6cm or more.

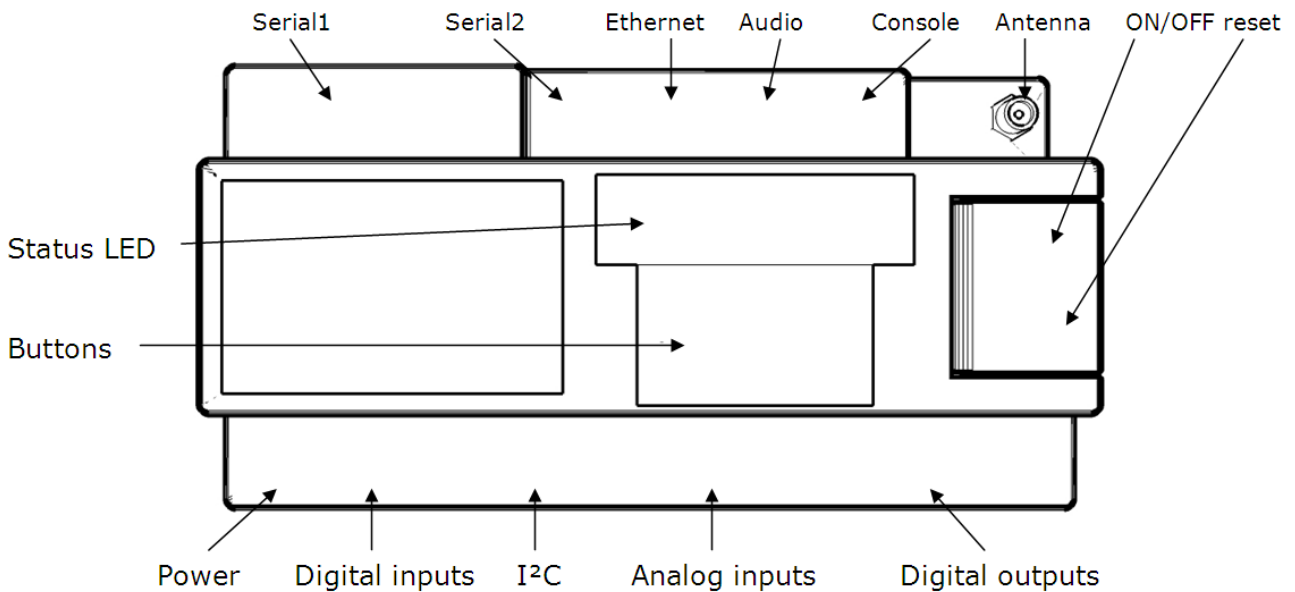

Accessible at the back, after removing safety cover: battery slot, SIM card holder, hardware configuration DIP switches. Disconnect all wires and cables from the M2MBoxPro before removing the safety cover.

1.2.1 Serial port 1

This is a RS232 serial interface on 9 pins D-subminiature female connector, that can be used to connect an external computer, a PSTN modem, an industrial machine or a wireless transceiver. The pin assignment is standard DCE pinout.

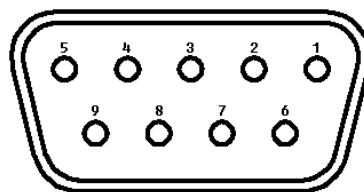

Pin number	Name	EIA designation	Type
1	DCD	Data Carrier Detect	Output
2	RXD	Receive Data	Output
3	TXD	Transmit Data	Input
4	DTR	Data Terminal Ready	Input
5	GND	Ground	Ground
6	DSR	Data Set Ready	Output
7	RTS	Request To Send	Input
8	CTS	Clear To Send	Output
9	RI	Ring Indicator	Output

Using a DIP switch, you can select pin 9 of the connector to be either the RI signal (output from the M2MBoxPro), either a +6V 380mA voltage output that can be used to power an external device. For energy saving, the +6V output is deactivated when the device is off.

ESD Protection: $\pm 8\text{kV}$ air discharge

Serial interface 1 is connected to Q26 UART1 interface.

1.2.2 Serial port 2

This 8P8C (RJ45) modular connector provides RS232 or isolated RS485 interface for connecting to industrial machines. A DIP switch is used to select between RS232 and isolated RS485 interface, and additional DIP switches are used to enable or disable termination, pull-up and pull-down resistors. On the RS232 interface, only 3 and 5 wires communication can be used.

Pin	Signal
1	RS485 B
2	RS485 A
3	RS485 GND
4	RS232 GND
5	RS232 RX
6	RS232 TX
7	RS232 CTS
8	RS232 RTS

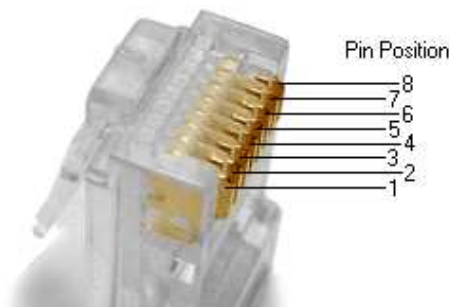

ESD Protection: $\pm 8\text{kV}$ air discharge RS485 isolation: 1500Vrms, short-circuit and overvoltage protected.

Both RS232 and RS485 are connected to Q26 UART2 interface.

RS485 communication channel is half-duplex. The M2MBoxPro sets the transmission direction (sender or receiver) automatically. When using RS485 the software needs to switch off the hardware flow control on UART2 (AT+IFC=0,0).

1.2.3 Ethernet

There is one LAN interface on the M2MBoxPro. The interface transceiver is a ENC28J60 from Microchip. It is directly connected to the Q26 SPI1 interface for data transfer, and also uses Q26 GPIO0 and GPIO25 signals for reset and interrupt, respectively.

The transceiver is IEEE 802.3 Compatible , has integrated MAC and 10 BASE-T PHY, supports one 10BASE-T port (full and half-duplex modes) through its 8P8C (RJ45) connector.

Two LEDs are available on the connector to check the communication status.

1.2.4 Audio

The M2MBoxPro provides a 4P4C connector to connect directly to a phone handset.

The pinout is industry standard:

Pin	Signal
1	Microphone -
2	Speaker -
3	Speaker +
4	Microphone +

ESD protection:±8kV air discharge TDMA noise reduction and EMC protection. Echo cancellation and noise reduction is done in software by the Q26 module. This interface connects to the Q26 MIC2 and SPK2 signals. MIC1 and SPK1 are not used.

1.2.5 USB console

The M2MBoxPro has a USB interface (labeled as console interface) that connects directly to the Q26 USB interface. The M2MBoxPro acts as a USB slave device.

- 12Mbit/s full-speed transfer rate
- 3.3V type compatible
- USB Soft connect feature
- Download feature is not supported by USB
- CDC 1.1 – ACM compliant

1.2.6 Power input

The M2MBoxPro takes DC voltage from 9VDC to 28VDC, and is protected against over and reverse voltage. It also has a resettable fuse for increased protection.

Resettable fuse rating: 900mA

There are four ways to turn on the M2MBoxPro:

- press the ON/OFF button for a short period of time
- while the M2MBoxPro is switched off, apply a positive voltage on digital input 0 (this can be deactivated using DIP switches)
- while the M2MBoxPro is disconnected and has no battery, connect the mains and apply a voltage between 9V to 28V DC on the power supply input
- use a Wavecom Q26 alarm

To turn off the M2MBoxPro, it is recommended to send the AT+CPOF command to the wireless processor. This can be done either by serial port, either by openAT. Once the device is powered on, the ON/OFF button can be sensed with Q26 GPIO4 signal. It is recommended that the openAT software polls this signal and send a AT+CPOF command after ON/OFF button is pushed for more than 10 seconds.

1.2.7 Battery

To continue operating when the mains power is cut, the M2MBoxPro embeds a 2000mAh lithium backup battery. The modem can operate for several days without being recharged.

It is possible for the openAT software to detect whether it is powered by the battery or by the mains by sensing GPIO12: if GPIO12 is high, the M2MBoxPro is powered by the mains. If GPIO12 is low, the device is powered by the battery.

The battery has a given lifetime of more than 300 charge cycles. It is recommended that the customer application software uses GPIO12 signal to count the number of charge cycles, so that it can estimate battery end of life.

Note that the M2MBoxPro does not use the Q26's integrated charging circuit, but an external one. The battery voltage can be measured using the Q26's ADC0 interface.

1.2.8 Digital inputs

The M2MBoxPro has 8 digital inputs. These are 0-24V rated and organized in two groups of four inputs, with one common voltage reference for each group of four. All digital inputs are voltage transient protected, with dissipation of 600W peak pulse power on 10/1000us waveform and 15A peak pulse current. For additional protection, the digital inputs are opto-isolated and offer 3750Vrms isolation. The digital inputs are connected to the Q26 CPU as follows:

Digital input	Q26 GPIO
0	10
1	8
2	6
3	5
4	7
5	13
6	11
7	9

For safety, the external power source that drives the inputs must be isolated from the M2MBoxPro power source.

1.2.9 I²C port

The Q26 CPU I²C interface is available on the casing for connecting to external pieces of hardware, on Grey screw terminal connector.

The interface is four pins, including the two SCL and SDA signals, a ground pin and a 2.8V voltage output. The 2.8V output is to be used as a voltage reference and can provide up to 100mA to power small I²C peripherals.

There are no pull-up resistors inside the devices. If needed, these will have to be added externally, but can be connected to the 2.8V reference voltage. If not using this voltage reference, note that the absolute maximum voltage that can be applied on the I²C signals is 3.1V.

The pin assignment is as follows:

Terminal block pin	Signal
1	SCL
2	SDA
3	GND
4	+2.8V

When facing the connector, with the M2MBoxPro LED up, the pin 1 is the leftmost pin.

ESD Protection: ± 8 kV air discharge

In the I²C bus, the M2MBoxPro is always the master, and the maximum transfer speed: 400kbps. For more information on the bus, refer to “I²C bus specifications version 2.0” from PHILIPS.

The 2.8V reference voltage can be deactivated using one of the M2MBoxPro configuration DIP switches.

1.2.10 Analog Inputs

There are two external analog inputs on the screw terminal blocks of the M2MBoxPro, and two more internal analog inputs for temperature and voltage sensor. The analog inputs can be either voltage or current inputs, controlled by two jumper switches. The analog inputs are protected with self-resettable fuses and transient protection diodes. Analog inputs are multiplexed, and the multiplexer address is set with Q26 GPIO 20 and GPIO 21 signals. To read the value of the inputs, please refer to the following table:

Analog signal	GPIO20	GPIO21
0	0	0
1	1	1
Temperature	0	1
Voltage	1	1

The selected analog channel is then available on the ADC input of the Q26 processor. For temperature sensors and voltage sensor specifications, refer to corresponding sections of this document.

Analog voltage range: 0-10V Analog current range: 0-20mA

ADC resolution: 10bits

Protections fuse rating: 80mA

Maximum peak power: 600 Watts (10/1000 ms)

1.2.11 Digital Outputs

The M2MBoxPro features 4 digital open collector outputs.

The outputs are connected to Q26’s GPIO22, GPIO23, GPIO24 and GPIO35 signals. They are opto-isolated and have an integrated fly-back protection diode

Isolation: 3750Vrms

Maximum base-collector voltage: 160V

Maximum continuous current: 600mA

Maximum power dissipation: 350mW at up to 25°C, derate at 2.8mW/°C above 25°C

1.2.12 LEDs and buttons

The M2MBoxPro user interface consists of 6 connection LEDs, 3 application LEDs and two user buttons.

The two user buttons are connected to Q26 GPIO 1 and GPIO 2 signals, and are debounced by hardware. There are two additional buttons, one that will instantly cause a reset of the processor (to use only in case of software crash), and a ON/OFF button whose function is described in the Power Source section of this document).

The three application LEDs are driven by the openAT application or by AT commands: GPIO32 drives the Status LED, GPIO33 drives the A1 LED and GPIO34 drives the A2 LED.

The connection LEDs are driven by hardware and give insight about the M2MBoxPro interfaces status:

- Power LED: is green when the M2MBoxPro is powered by the mains, and yellow if it is powered by the battery
- GSM LED: is solid if the M2MBoxPro can't connect to the cellular network, and is blinking otherwise
- LAN, Serial1, Serial2 and I²C LEDs are flashing when there is activity on their respective interface.

1.2.13 Battery slot

The battery slot is accessible by removing the two philips screws of the battery cover. Disconnect all wires and cables from the M2MBoxPro before removing the safety cover.











Do not use any other battery than the one supplied by Maestro Wireless solutions ltd.

1.2.14 SIM holder

The SIM holder is accessible after removing the battery. Disconnect and remove the battery before you attempt to install or change the SIM card.

1.2.15 Hardware configuration DIP switches

There are three sets of hardware configuration DIP switches located at the back of the M2MBoxPro. To access these switches, you have to remove the safety cover by removing the two philips head screws. Disconnect all wires and cables from the M2MBoxPro before removing the safety cover.

	Disabled		Enabled	RS485 Termination RES.
	Disabled		Enabled	RS485 Pullup RES.
	Disabled		Enabled	RS485 Pulldown RES.
	0-10V		0-20mA	Analog input1 mode
	0-10V		0-20mA	Analog input2 mode
Pin9 Serial1	Enabled		Disabled	Serial 1
6V	Enabled		Disabled	Serial 2
NC	RS-485		RS-232	Serial2 mode
Ring	Enabled		Disabled	I2C Power output
	Disabled		Enabled	Factory download mode
	Disabled		Enabled	DI wakeup

The DIP switches usage is as follows:

- Pin 9 Serial 1: sets the signal connected to pin 9 of the serial 1 interface. 6V is a 6V 380mA voltage output that can be used to power external devices. NC makes the pin 9 floating, and ring connects the pin 9 to RS232 RI signal (standard modem port pinout)
- RS485 termination res. : enables or disables a 120ohm shunt resistor between the two wires of the Serial2 RS interface.
- RS485 pull-up res.: enables or disables a 560ohm resistor to pull-up RS485+ signal to 5V. This 5V voltage is isolated from the other interfaces of the M2MBoxPro. It is defined by reference to the pull-down voltage.
- RS485 pulldown res.: enables or disables a 560ohm resistor to pull-down RS485- signal to 0V. This 0V voltage is isolated from the other interfaces of the M2MBoxPro. It is defined by reference to the pull-up voltage.
- Analog input1 mode: enables or disables a 500ohm shunt resistor across the pins of the AI0 input (0-20mA mode). When this resistor is disabled, AI0 input impedance is 50.2kohm (0-10V mode)
- Analog input2 mode: enables or disables a 500ohm shunt resistor across the pins of the AI1 input (0-20mA mode). When this resistor is disabled, AI0 input impedance is 50.2kohm (0-10V mode)
- Serial1: enables or disables the serial port driver of serial1 interface, for power saving
- Serial2: enables or disables the serial port driver of serial2 interface, for power saving
- Serial2 mode: sets the serial2 interface to operate either in RS232, either in RS485 mode.
- I2C power output: enable or disable the 2.8V power output on the I²C interface connector, for power saving.
- DI wake-up: enable or disable the modem start-up circuit connected to DI0. When enabled, any rising edge on DI0 will cause the modem to switch on. When disabled, DI0 will not start the modem.

Chapter 2

Installation

2.1 Inserting SIM card and battery

Use a small Philips head screwdriver to remove the two screws of the battery cover. The gently slide the cover out.

Under the cover you will see the battery and the hardware configuration DIP switches.

Take the battery out of its slot to reveal the SIM card holder. Slide and rotate the holder, insert the SIM card and put the holder back in closed position. Make sure that the SIM card holder is correctly secured.

If you need to modify the hardware configuration through the DIP switches, now is the good time. Consult Maestro or your distributor if you are not sure about the correct position of the switches.

Now put back the battery into its slot, and connect the battery connector to the socket on the M2MBoxPro motherboard. The socket is foolproof so you can not connect the battery wrongly.

When shipping from Maestro, the battery will always be disconnected. Do not forget to connect the battery before using the M2MBoxPro.

2.2 Mounting the M2MBoxPro

The M2MBoxPro is designed to be mounted on 35mm DIN rail.

First align the bottom part of the mount groove of the M2MBoxPro against the bottom side of the DIN rail, then push the device against the rail until you hear a click sound. The M2MBoxPro is now secured on the DIN rail.

To remove the M2MBoxPro from the DIN rail, use a flat head screwdriver to lift the top blue DIN clip of the device, then take out the device. In case the blue DIN clip falls off the M2MBoxPro, put it back in its slot.

2.3 Connect the external antenna (SMA type)

Connect this to an external antenna with SMA male connector. If you are using a different antenna than the one provided, make sure it is for the GSM frequency with impedance of 50ohm, and also connector is secured tightly.

Note: Please use antenna designed for GSM device operation. Incorrect antenna will affect communication and even damage the modem.

2.4 Connect the modem to external device

You can use the provided RS232 serial cable to connect the M2MBoxPro Serial1 interface to an external controller or computer.

2.5 Connect the DC power supply

Connect the two tips of the provided power cord to a DC supply. Refer to the following for power supply requirement.

Input voltage range	9V – 28V
Rated current	850mA

Insert the two tips into the “Power” terminal block of the M2MBoxPro, screw the connector to secure the wires then connect it to the M2MBoxPro. The modem will turn on automatically (if not already on).

The GPRS status indicator on the modem will be lit when power on. After a few seconds it will go flashing slowly (registered on cellular network).

Chapter 3

Hardware block diagram

The following block diagram is intended as a device map for embedded software developers to create their own user applications on the M2MboxPro. It shows the various hardware interfaces and the way they are connected to the Q2686 Wireless processor.

