

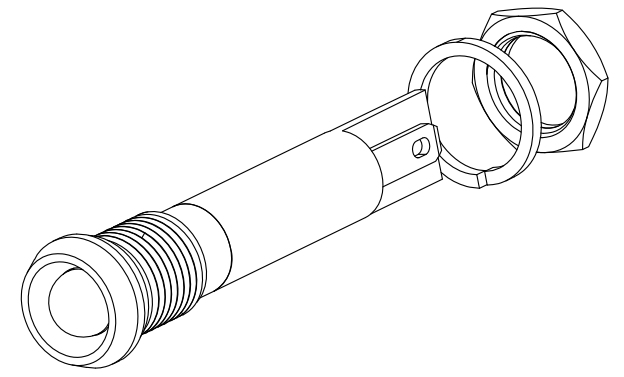

REV.	DESCRIPTION	DATE	APPROVED
A	Engineering Release	08/18/14	J. C.
B	Engineering Update w/o Changes	08/11/16	J. C.

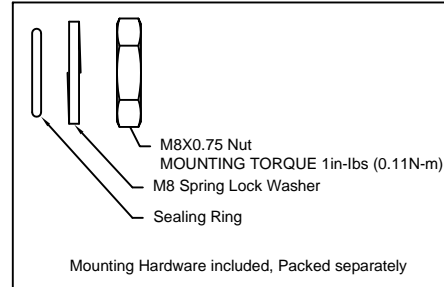

M8X0.75 Nut
RECOMMENDED MOUNTING TORQUE
 1in-lbs (0.11N-m)

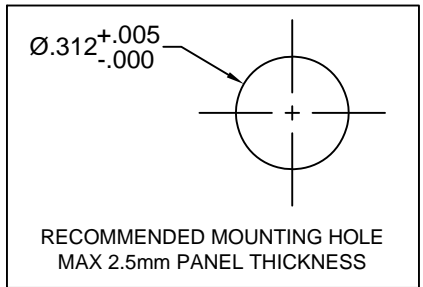

- NOTES:**
1. SEALED TO IP54 RATING
 2. VOLTAGE INPUT OPTIONS: 12V/24V/110V/220V
 3. ROHS COMPLIANT
 4. MOUNTING HARDWARE PACKED SEPARATELY NON-ASSEMBLED
 5. INSERT SEALING RING ON PANEL MOUNT ASSEMBLY PRIOR TO PANEL INSTALLATION

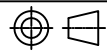
STANDARD TOLERANCE (UNLESS OTHERWISE SPECIFIED)		 4 THOMAS, IRVINE, CA. 92618 TEL: (949) 951-8808 FAX: (949) 951-3974					
DECIMALS	ANGULAR						
.X ±.1	X° ±1°		TITLE: MPC8-1 SERIES, IP54 RATED PANEL MOUNT INDICATOR				
.XX ±.02				DESIGNED: M. Doan	DATE: 08/18/14	PART NO: MPC8-1XDXXV	REVISION: B
.XXX ±.010				CHECKED: B. Oliver	DATE: 08/18/14	CAGE CODE : 32559	SHEET # 1 OF 2

REV.	DESCRIPTION	DATE	APPROVED
	SEE SHEET #1		

Part Number	Dominant Wave Length λ_d (nm)	Emitted Color	Lens Appearance	Voltage	Luminous Intensity (mcd)	Viewing Angle (degree)
MPC8-1RD12V	625	Red	Diffused	12V	310	45
MPC8-1GD12V	515	Green	Diffused	12V	2090	45
MPC8-1YD12V	590	Yellow	Diffused	12V	310	45
MPC8-1BWD12V	470	Blue	Diffused	12V	625	45
MPC8-1WD12V	x=0.36, y=0.32	White	Diffused	12V	4910	45
MPC8-1RD24V	625	Red	Diffused	24V	310	45
MPC8-1GD24V	515	Green	Diffused	24V	2090	45
MPC8-1YD24V	590	Yellow	Diffused	24V	310	45
MPC8-1BWD24V	470	Blue	Diffused	24V	625	45
MPC8-1WD24V	x=0.36, y=0.32	White	Diffused	24V	4910	45
MPC8-1RD110V	625	Red	Diffused	110V	20	45
MPC8-1GD110V	515	Green	Diffused	110V	125	45
MPC8-1YD110V	590	Yellow	Diffused	110V	20	45
MPC8-1BWD110V	470	Blue	Diffused	110V	40	45
MPC8-1WD110V	x=0.36, y=0.32	White	Diffused	110V	165	45
MPC8-1RD220V	625	Red	Diffused	220V	10	45
MPC8-1GD220V	515	Green	Diffused	220V	60	45
MPC8-1YD220V	590	Yellow	Diffused	220V	10	45
MPC8-1BWD220V	470	Blue	Diffused	220V	20	45
MPC8-1WD220V	x=0.36, y=0.32	White	Diffused	220V	80	45

ABSOLUTE MAXIMUM RATINGS (Ta = 25°C)

POWER INPUT _____ 0.5W MAX
 OPERATING TEMPERATURE RANGE _____ -40°C ~ 80°C
 STORAGE TEMPERATURE _____ -40°C ~ 80°C
 TERMINAL SOLDERING TEMPERATURE _____ 260°C, 5s

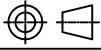
STANDARD TOLERANCE (UNLESS OTHERWISE SPECIFIED) DECIMALS ANGULAR		 4 THOMAS, IRVINE, CA. 92618 TEL: (949) 951-8808 FAX: (949) 951-3974	
			
DESIGNED: M. Doan	DATE: 08/18/14	TITLE: MPC8-1 SERIES, IP54 RATED PANEL MOUNT INDICATOR	
CHECKED: B. Oliver	DATE: 08/18/14	PART NO: MPC8-1XDXXV	REVISION: B
		CAGE CODE : 32559	SHEET # 2 OF 2
CAD GENERATED DOCUMENT. DO NOT MEASURE DRAWING.			