

REV.	DESCRIPTION	DATE	APPROVED
A	Engineering Release	08/18/14	J. C.
B	Engineering Update w/o Changes	08/11/16	J. C.

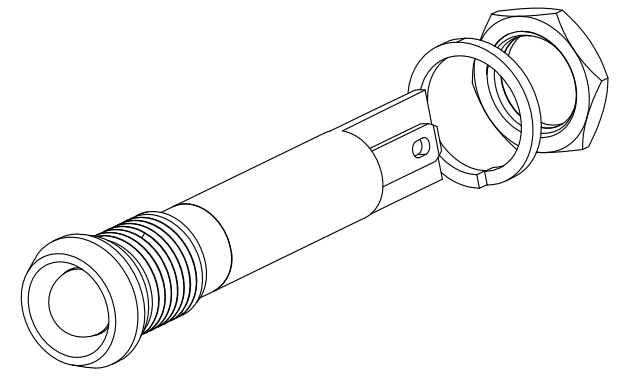

M8X0.75 Nut  
**RECOMMENDED MOUNTING TORQUE**  
 1in-lbs (0.11N-m)

Quick Connect Terminal  
 0.110" Wide X 0.030" Thick Blades  
 Terminal 1: Bronze Color  
 Terminal 2: Silver Color

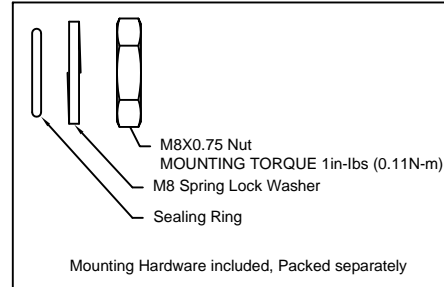
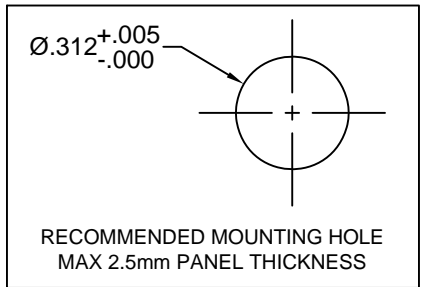

- NOTES:**
1. SEALED TO IP54 RATING
  2. VOLTAGE INPUT OPTIONS: 12V/24V/110V/220V
  3. ROHS COMPLIANT
  4. MOUNTING HARDWARE PACKED SEPARATELY NON-ASSEMBLED
  5. INSERT SEALING RING ON PANEL MOUNT ASSEMBLY PRIOR TO PANEL INSTALLATION

STANDARD TOLERANCE (UNLESS OTHERWISE SPECIFIED)		BIVAR®	
DECIMALS	ANGULAR	4 THOMAS, IRVINE, CA. 92618	
.X ± .1	X° ± 1°	TEL: (949) 951-8808 FAX: (949) 951-3974	
.XX ± .02		<b>TITLE:</b> MPC8-1 SERIES, IP54 RATED PANEL MOUNT INDICATOR	
.XXX ± .010		<b>PART NO:</b> MPC8-1XDXXV	<b>REVISION:</b> B
<b>DESIGNED:</b> M. Doan	<b>DATE:</b> 08/18/14	<b>CAGE CODE :</b> 32559	<b>SHEET #</b> 1 OF 2
<b>CHECKED:</b> B. Oliver	<b>DATE:</b> 08/18/14	CAD GENERATED DOCUMENT. DO NOT MEASURE DRAWING.	

REV.	DESCRIPTION	DATE	APPROVED
	SEE SHEET #1		

Part Number	Dominant Wave Length $\lambda_d$ (nm)	Emitted Color	Lens Appearance	Voltage	Luminous Intensity (mcd)	Viewing Angle (degree)
MPC8-1RD12V	625	Red	Diffused	12V	310	45
MPC8-1GD12V	515	Green	Diffused	12V	2090	45
MPC8-1YD12V	590	Yellow	Diffused	12V	310	45
MPC8-1BWD12V	470	Blue	Diffused	12V	625	45
MPC8-1WD12V	x=0.36, y=0.32	White	Diffused	12V	4910	45
MPC8-1RD24V	625	Red	Diffused	24V	310	45
MPC8-1GD24V	515	Green	Diffused	24V	2090	45
MPC8-1YD24V	590	Yellow	Diffused	24V	310	45
MPC8-1BWD24V	470	Blue	Diffused	24V	625	45
MPC8-1WD24V	x=0.36, y=0.32	White	Diffused	24V	4910	45
MPC8-1RD110V	625	Red	Diffused	110V	20	45
MPC8-1GD110V	515	Green	Diffused	110V	125	45
MPC8-1YD110V	590	Yellow	Diffused	110V	20	45
MPC8-1BWD110V	470	Blue	Diffused	110V	40	45
MPC8-1WD110V	x=0.36, y=0.32	White	Diffused	110V	165	45
MPC8-1RD220V	625	Red	Diffused	220V	10	45
MPC8-1GD220V	515	Green	Diffused	220V	60	45
MPC8-1YD220V	590	Yellow	Diffused	220V	10	45
MPC8-1BWD220V	470	Blue	Diffused	220V	20	45
MPC8-1WD220V	x=0.36, y=0.32	White	Diffused	220V	80	45

**ABSOLUTE MAXIMUM RATINGS (Ta = 25°C)**

POWER INPUT \_\_\_\_\_ 0.5W MAX  
 OPERATING TEMPERATURE RANGE \_\_\_\_\_ -40°C ~ 80°C  
 STORAGE TEMPERATURE \_\_\_\_\_ -40°C ~ 80°C  
 TERMINAL SOLDERING TEMPERATURE \_\_\_\_\_ 260°C, 5s

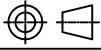
STANDARD TOLERANCE (UNLESS OTHERWISE SPECIFIED) DECIMALS                      ANGULAR		 4 THOMAS, IRVINE, CA. 92618 TEL: (949) 951-8808    FAX: (949) 951-3974	
			
DESIGNED: <b>M. Doan</b>	DATE: <b>08/18/14</b>	<b>TITLE:</b> MPC8-1 SERIES, IP54 RATED PANEL MOUNT INDICATOR	
CHECKED: <b>B. Oliver</b>	DATE: <b>08/18/14</b>	<b>PART NO:</b> MPC8-1XDXXV	REVISION: <b>B</b>
		<b>CAGE CODE :</b> 32559	<b>SHEET #</b> 2 OF 2
CAD GENERATED DOCUMENT. DO NOT MEASURE DRAWING.			