

| REV. | DESCRIPTION                    | DATE     | APPROVED |
|------|--------------------------------|----------|----------|
| A    | Engineering Release            | 08/18/14 | J. C.    |
| B    | Engineering Update w/o Changes | 08/11/16 | J. C.    |
|      |                                |          |          |
|      |                                |          |          |

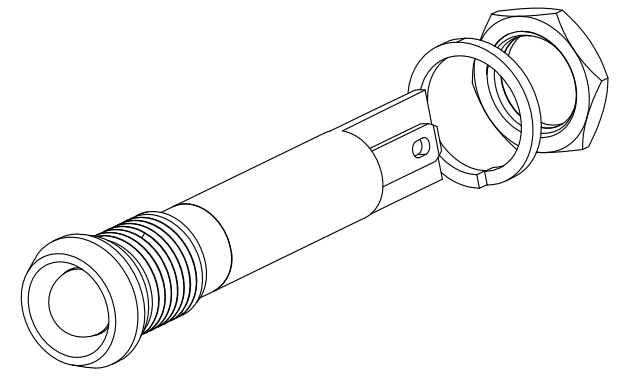

M8X0.75 Nut  
**RECOMMENDED MOUNTING TORQUE**  
 1in-lbs (0.11N-m)

Quick Connect Terminal  
 0.110" Wide X 0.030" Thick Blades  
 Terminal 1: Bronze Color  
 Terminal 2: Silver Color

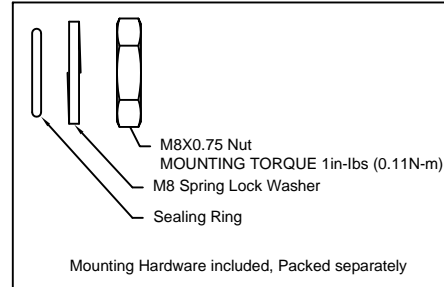
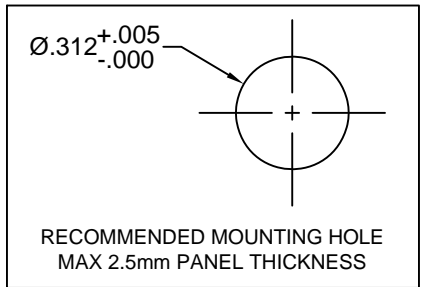

- NOTES:**
1. SEALED TO IP54 RATING
  2. VOLTAGE INPUT OPTIONS: 12V/24V/110V/220V
  3. ROHS COMPLIANT
  4. MOUNTING HARDWARE PACKED SEPARATELY NON-ASSEMBLED
  5. INSERT SEALING RING ON PANEL MOUNT ASSEMBLY PRIOR TO PANEL INSTALLATION

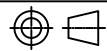
|  |                          |   |                                |
|--|--------------------------|---|--------------------------------|
| STANDARD TOLERANCE<br>(UNLESS OTHERWISE SPECIFIED) |                          | <br>4 THOMAS, IRVINE, CA. 92618<br>TEL: (949) 951-8808 FAX: (949) 951-3974 |                                |
| DECIMALS   | ANGULAR                  |   |                                |
| .X ± .1  | X° ± 1°                  |  <b>TITLE:</b> MPC8-1 SERIES, IP54 RATED<br>PANEL MOUNT INDICATOR          |                                |
| .XX ± .02  |                          |   | <b>PART NO:</b><br>MPC8-1XDXXV |
| .XXX ± .010  |                          |   | <b>REVISION:</b><br>B          |
| DESIGNED:<br><b>M. Doan</b>                        | DATE:<br><b>08/18/14</b> | <b>CAGE CODE :</b> 32559  | <b>SHEET #</b> 1 OF 2          |
| CHECKED:<br><b>B. Oliver</b>                       | DATE:<br><b>08/18/14</b> | CAD GENERATED DOCUMENT. DO NOT MEASURE DRAWING.   |                                |

|      |              |      |          |
|------|--------------|------|----------|
| REV. | DESCRIPTION  | DATE | APPROVED |
|      | SEE SHEET #1 |      |          |

| Part Number   | Dominant Wave Length $\lambda_d$ (nm) | Emitted Color | Lens Appearance | Voltage | Luminous Intensity (mcd) | Viewing Angle (degree) |
|---------------|---------------------------------------|---------------|-----------------|---------|--------------------------|------------------------|
| MPC8-1RD12V   | 625                                   | Red           | Diffused        | 12V     | 310                      | 45                     |
| MPC8-1GD12V   | 515                                   | Green         | Diffused        | 12V     | 2090                     | 45                     |
| MPC8-1YD12V   | 590                                   | Yellow        | Diffused        | 12V     | 310                      | 45                     |
| MPC8-1BWD12V  | 470                                   | Blue          | Diffused        | 12V     | 625                      | 45                     |
| MPC8-1WD12V   | x=0.36, y=0.32                        | White         | Diffused        | 12V     | 4910                     | 45                     |
| MPC8-1RD24V   | 625                                   | Red           | Diffused        | 24V     | 310                      | 45                     |
| MPC8-1GD24V   | 515                                   | Green         | Diffused        | 24V     | 2090                     | 45                     |
| MPC8-1YD24V   | 590                                   | Yellow        | Diffused        | 24V     | 310                      | 45                     |
| MPC8-1BWD24V  | 470                                   | Blue          | Diffused        | 24V     | 625                      | 45                     |
| MPC8-1WD24V   | x=0.36, y=0.32                        | White         | Diffused        | 24V     | 4910                     | 45                     |
| MPC8-1RD110V  | 625                                   | Red           | Diffused        | 110V    | 20                       | 45                     |
| MPC8-1GD110V  | 515                                   | Green         | Diffused        | 110V    | 125                      | 45                     |
| MPC8-1YD110V  | 590                                   | Yellow        | Diffused        | 110V    | 20                       | 45                     |
| MPC8-1BWD110V | 470                                   | Blue          | Diffused        | 110V    | 40                       | 45                     |
| MPC8-1WD110V  | x=0.36, y=0.32                        | White         | Diffused        | 110V    | 165                      | 45                     |
| MPC8-1RD220V  | 625                                   | Red           | Diffused        | 220V    | 10                       | 45                     |
| MPC8-1GD220V  | 515                                   | Green         | Diffused        | 220V    | 60                       | 45                     |
| MPC8-1YD220V  | 590                                   | Yellow        | Diffused        | 220V    | 10                       | 45                     |
| MPC8-1BWD220V | 470                                   | Blue          | Diffused        | 220V    | 20                       | 45                     |
| MPC8-1WD220V  | x=0.36, y=0.32                        | White         | Diffused        | 220V    | 80                       | 45                     |

**ABSOLUTE MAXIMUM RATINGS (Ta = 25°C)**

POWER INPUT \_\_\_\_\_ 0.5W MAX  
 OPERATING TEMPERATURE RANGE \_\_\_\_\_ -40°C ~ 80°C  
 STORAGE TEMPERATURE \_\_\_\_\_ -40°C ~ 80°C  
 TERMINAL SOLDERING TEMPERATURE \_\_\_\_\_ 260°C, 5s

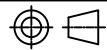
|   |                          |  |                       |
|---|--------------------------|--|-----------------------|
| STANDARD TOLERANCE<br>(UNLESS OTHERWISE SPECIFIED)<br>DECIMALS                      ANGULAR |                          | <br>4 THOMAS, IRVINE, CA. 92618<br>TEL: (949) 951-8808    FAX: (949) 951-3974 |                       |
|        |                          |  |                       |
| DESIGNED:<br><b>M. Doan</b>   | DATE:<br><b>08/18/14</b> | <b>TITLE:</b> MPC8-1 SERIES, IP54 RATED<br>PANEL MOUNT INDICATOR   |                       |
| CHECKED:<br><b>B. Oliver</b>  | DATE:<br><b>08/18/14</b> | <b>PART NO:</b><br>MPC8-1XDXXV   | REVISION:<br><b>B</b> |
|   |                          | <b>CAGE CODE :</b> 32559   | <b>SHEET #</b> 2 OF 2 |
| CAD GENERATED DOCUMENT. DO NOT MEASURE DRAWING.   |                          |  |                       |