

High Dynamic Range Low Noise Amplifier 400 - 500 MHz

Rev. V1

Features

- Low Noise Figure: 0.9 dB
- High OIP3: +28 dBm at 5 V, 60 mA bias
- High Gain: 21 dB
- Single Supply: +3 to +8 VDC
- Lead-Free SOIC-8 Package
- 100% Matte Tin Plating over Copper
- Halogen-Free "Green" Mold Compound
- 260°C Reflow Compatible
- RoHS* Compliant Version of MAALSS0025
- Adjustable current: 20 to 80 mA with external resistor

Description

M/A-COM's MAAL-008624 is a high dynamic range, low noise GaAs MMIC amplifier in a low cost, surface mount package. It employs external input matching to obtain optimum noise figure performance and operating frequency flexibility.

The MAAL-008624 also features flexible biasing to control the current consumption vs. dynamic range trade-off. The MAAL-008624 can operate from any supply voltage in the 3 V to 8 V range. Its current can be controlled over a range of 20 mA to 80 mA with an external resistor.

The MAAL-008624 is ideally suited for use where low noise figure, high gain, high dynamic range, and low power consumption are required. Typical applications include receiver front ends in CDMA450 base stations. It is also useful as a gain block, buffer, driver, and IF amplifier in both fixed and portable cellular and 450 MHz ISM systems.

The MAAL-008624 is fabricated using a low-cost 0.5-micron gate length GaAs process. The process features full passivation for increased performance reliability.

Ordering Information¹

Part Number	Package
MAAL-008624-000000	Bulk Packaging
MAAL-008624-TR3000	3000 piece reel

1. Reference Application Note M513 for reel size information.

* Restrictions on Hazardous Substances, European Union Directive 2002/95/EC.

Functional Block Diagram

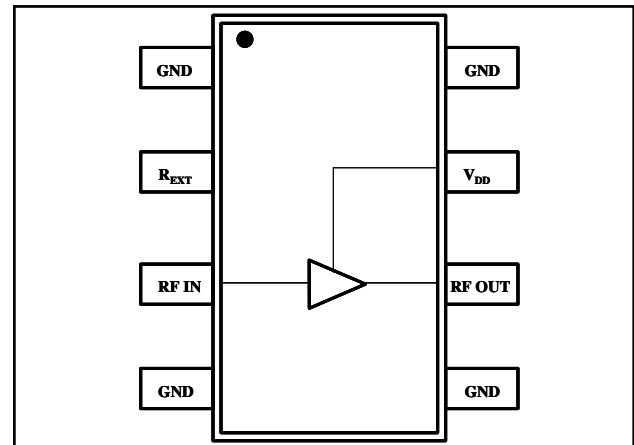

Pin Configuration

Pin No.	Pin Name	Description
1	GND	RF and DC Ground
2	R _{EXT}	External Current Control (optional)
3	RF IN	RF Input
4	GND	RF and DC Ground
5	GND	RF and DC Ground
6	RF OUT	RF Output
7	V _{DD}	Positive supply voltage
8	GND	RF and DC Ground

Absolute Maximum Ratings²

Parameter	Absolute Maximum
V _{DD}	+10 VDC
Input Power	+10 dBm
Current ³	120 mA
Channel Temperature ⁴	+150°C
Operating Temperature	-40°C to +85°C
Storage Temperature	-65°C to +150°C

2. Exceeding any one or combination of these limits may cause permanent damage to this device.
3. When pin #2 is used to increase current (see note 5).
4. Thermal resistance (θ_{jc}) = +88°C/W.

ADVANCED: Data Sheets contain information regarding a product M/A-COM Technology Solutions is considering for development. Performance is based on target specifications, simulated results, and/or prototype measurements. Commitment to develop is not guaranteed.

PRELIMINARY: Data Sheets contain information regarding a product M/A-COM Technology Solutions has under development. Performance is based on engineering tests. Specifications are typical. Mechanical outline has been fixed. Engineering samples and/or test data may be available. Commitment to produce in volume is not guaranteed.

- **North America** Tel: 800.366.2266 / Fax: 978.366.2266
 - **Europe** Tel: 44.1908.574.200 / Fax: 44.1908.574.300
 - **Asia/Pacific** Tel: 81.44.844.8296 / Fax: 81.44.844.8298
- Visit www.macomtech.com for additional data sheets and product information.

M/A-COM Technology Solutions Inc. and its affiliates reserve the right to make changes to the product(s) or information contained herein without notice.

High Dynamic Range Low Noise Amplifier 400 - 500 MHz

Rev. V1

Electrical Specifications: $T_A = +25^\circ\text{C}$, $Z_0 = 50 \Omega$, $F = 450 \text{ MHz}$, $P_{in} = -30 \text{ dBm}$

Parameter	Test Conditions	Units	Min	Typ	Max
Gain	5 V, 60 mA ⁵	dB	19	21	24
Noise Figure	5 V, 60 mA ⁵	dB	—	0.9	1.4
Input Return Loss	—	dB	—	9	—
Output Return Loss	—	dB	—	11	—
Output 1 dB Compression	5 V, 60 mA ⁵	dBm	—	16.5	—
Output IP3	5 V, 60 mA ⁵	dBm	—	28	—
Input IP3	5 V, 60 mA ⁵	dBm	3	7	—
Reverse Isolation	—	dB	—	34	—

5. Using external 15-ohm resistor. See functional schematic.

Functional Schematic

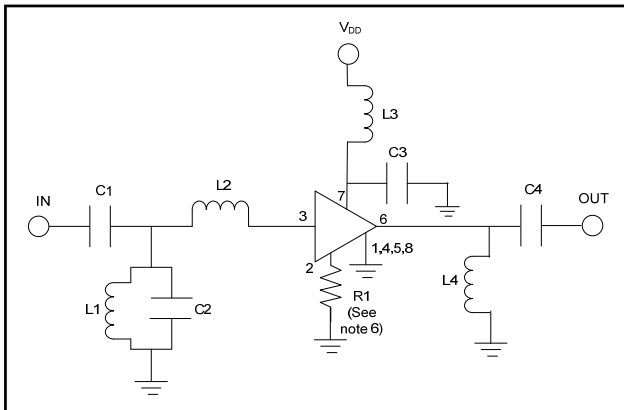

Handling Procedures

The following precautions should be observed to avoid damage:

Static Sensitivity

Gallium Arsenide Integrated Circuits are sensitive to electrostatic discharge (ESD) and can be damaged by static electricity. Proper ESD control techniques should be used when handling these devices.

External Circuitry Parts List

Part	Value	Purpose
C1	100 pF	DC Block
C2	8 pF	Input Matching
C3	470 pF	Bypass
C4	4 pF	Output Matching
L1	22 nH	Input Matching
L2	43 nH	Input Matching
L3	12 nH	RF Choke
L4	11 nH	Output Matching
R1	15 Ohms	Optional current control ⁶

6. Pin 2 allows use of an external resistor to ground for optional, higher current. For 20 mA operation, no resistor is used.

For $I_{DD} \sim 40 \text{ mA}$, $R_2 = 43 \text{ ohms}$;
 $I_{DD} \sim 60 \text{ mA}$, $R_2 = 15 \text{ ohms}$;
 $I_{DD} \sim 80 \text{ mA}$, $R_2 = 10 \text{ ohms}$.

Typical Performance Curves over Temperature

Gain

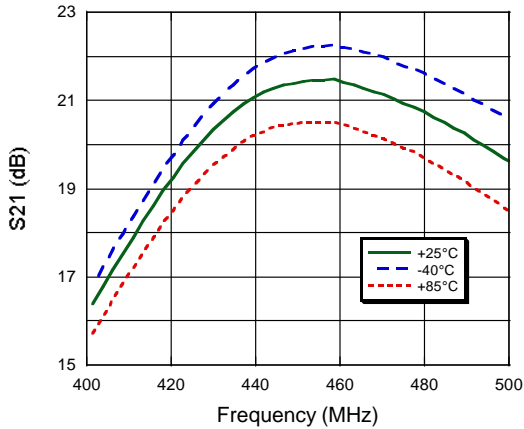

Reverse Isolation

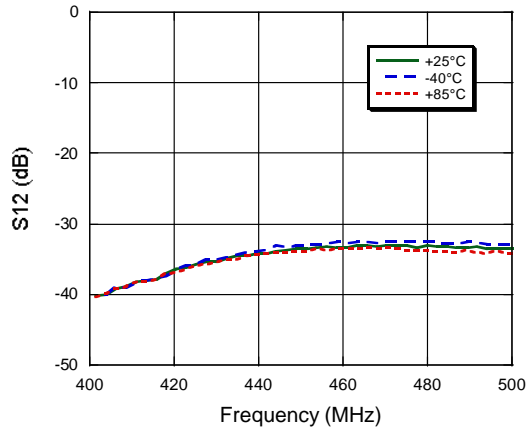

Input Return Loss

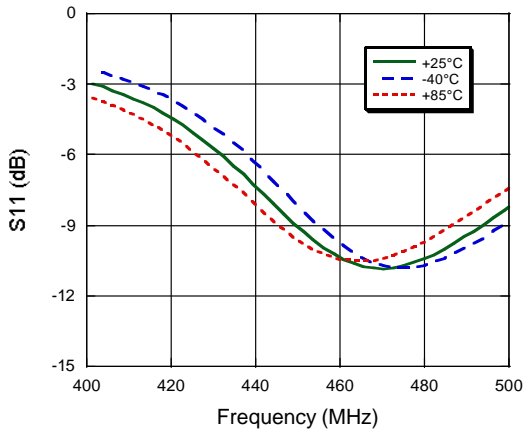

Output Return Loss

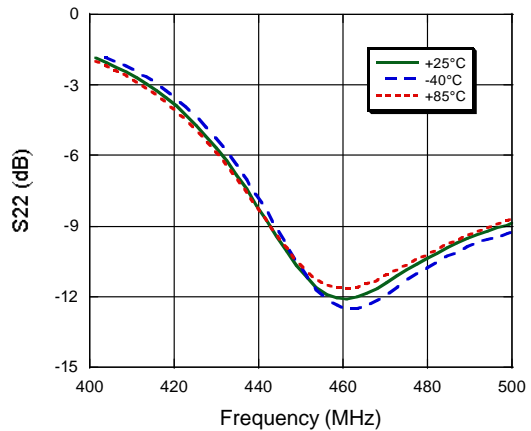

Noise Figure

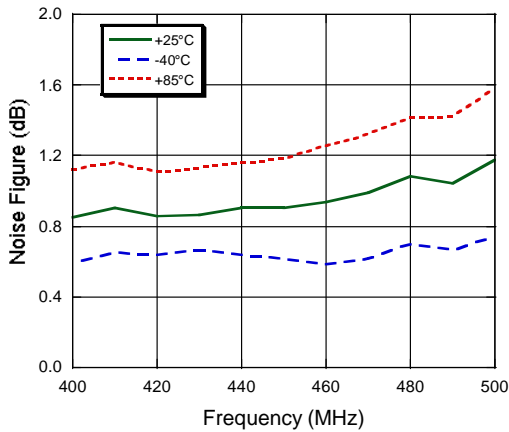

Output IP3

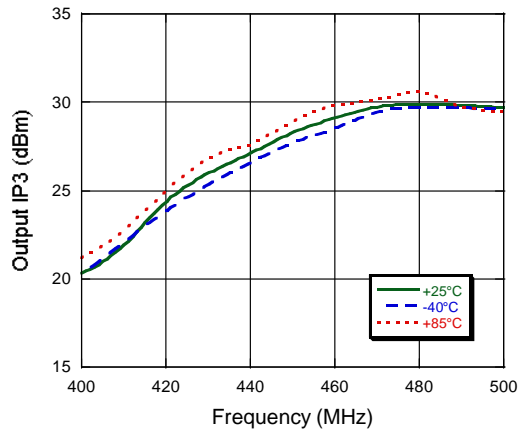

Lead-Free SOIC-8[†]

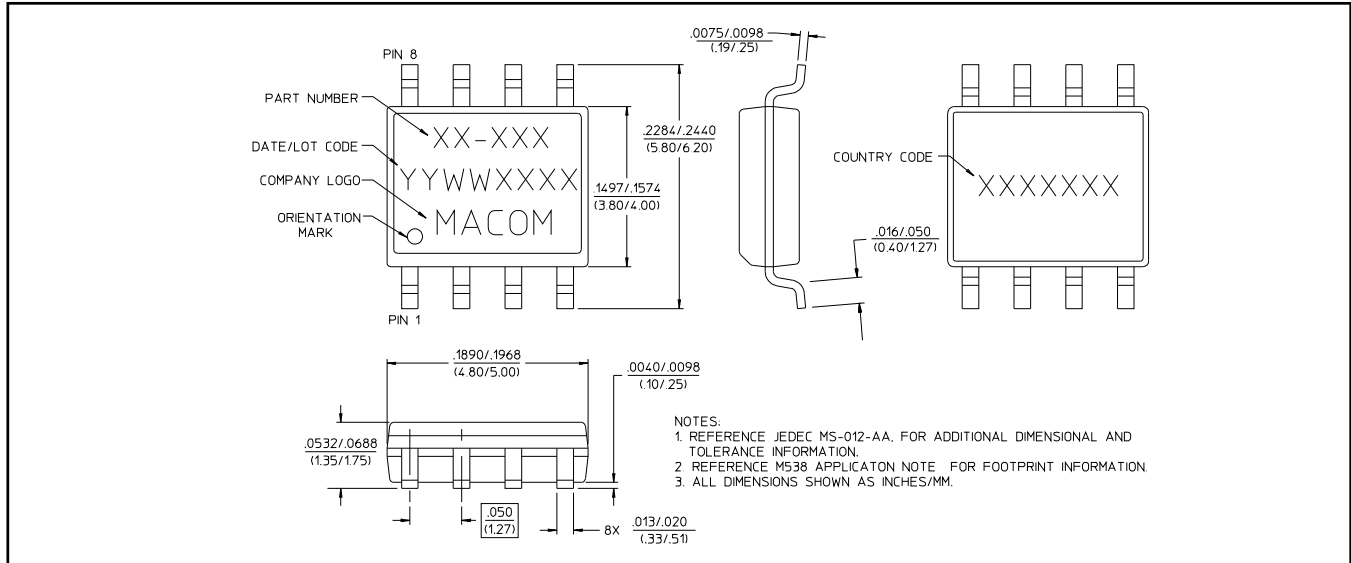

[†] Reference Application Note M538 for lead-free solder reflow recommendations.
 Meets JEDEC moisture sensitivity level 1 requirements.

Recommended PCB Configuration

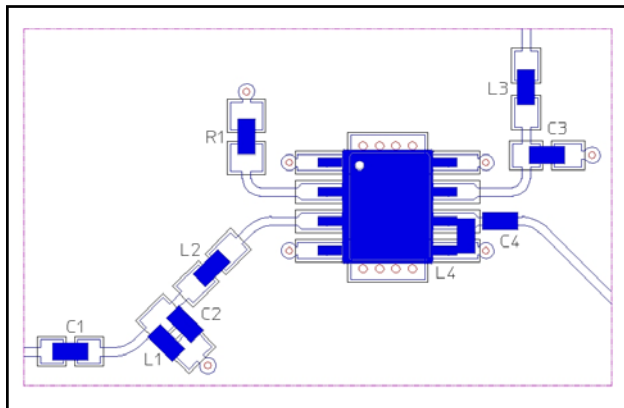

Cross Section View

