

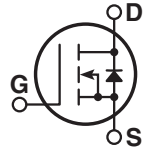

Super Junction MOSFET

- Ultra Low $R_{DS(ON)}$
- Low Miller Capacitance
- Ultra Low Gate Charge, Q_g
- Avalanche Energy Rated
- Extreme dv/dt Rated
- Popular TO-247 or Surface Mount D³ package.

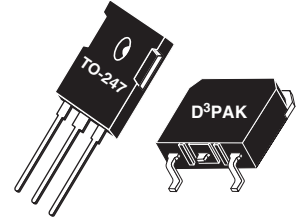

MAXIMUM RATINGS

All Ratings per die: $T_C = 25^\circ\text{C}$ unless otherwise specified.

Symbol	Parameter	APT77N60B_SC6	UNIT
V_{DSS}	Drain-Source Voltage	600	Volts
I_D	Continuous Drain Current @ $T_C = 25^\circ\text{C}$	77	Amps
	Continuous Drain Current @ $T_C = 100^\circ\text{C}$	49	
I_{DM}	Pulsed Drain Current ¹	272	
V_{GS}	Gate-Source Voltage Continuous	± 20	Volts
P_D	Total Power Dissipation @ $T_C = 25^\circ\text{C}$	481	Watts
T_J, T_{STG}	Operating and Storage Junction Temperature Range	- 55 to 150	$^\circ\text{C}$
T_L	Lead Temperature: 0.063" from Case for 10 Sec.	300	
I_{AR}	Avalanche Current ²	13.4	Amps
E_{AR}	Repetitive Avalanche Energy ² ($I_D = 13.4\text{A}, V_{DD} = 50\text{V}$)	2.96	mJ
E_{AS}	Single Pulse Avalanche Energy ($I_D = 13.4\text{A}, V_{DD} = 50\text{V}$)	1954	

STATIC ELECTRICAL CHARACTERISTICS

Symbol	Characteristic / Test Conditions	MIN	TYP	MAX	UNIT
$BV_{(DSS)}$	Drain-Source Breakdown Voltage ($V_{GS} = 0\text{V}, I_D = 250\mu\text{A}$)	600			Volts
$R_{DS(on)}$	Drain-Source On-State Resistance ³ ($V_{GS} = 10\text{V}, I_D = 44.4\text{A}$)		.037	.041	Ohms
I_{DSS}	Zero Gate Voltage Drain Current ($V_{DS} = V_{DSS}, V_{GS} = 0\text{V}, T_C = 25^\circ\text{C}$)			25	μA
	Zero Gate Voltage Drain Current ($V_{DS} = V_{DSS}, V_{GS} = 0\text{V}, T_C = 150^\circ\text{C}$)			250	
I_{GSS}	Gate-Source Leakage Current ($V_{GS} = \pm 20\text{V}, V_{DS} = 0\text{V}$)			± 100	nA
$V_{GS(th)}$	Gate Threshold Voltage ($V_{DS} = V_{GS}, I_D = 2.96\text{mA}$)	2.5	3	3.6	Volts



CAUTION: These Devices are Sensitive to Electrostatic Discharge. Proper Handling Procedures Should Be Followed.

"COOLMOS™ comprise a new family of transistors developed by Infineon Technologies AG. "COOLMOS" is a trademark of Infineon Technologies AG."

Microsemi Website - <http://www.microsemi.com>

DYNAMIC CHARACTERISTICS

APT77N60B_SC6

Symbol	Characteristic	Test Conditions	MIN	TYP	MAX	UNIT
C _{iss}	Input Capacitance	V _{GS} = 0V V _{DS} = 25V f = 1 MHz		13600		pF
C _{oss}	Output Capacitance			4400		
C _{rss}	Reverse Transfer Capacitance			290		
Q _g	Total Gate Charge ⁴	V _{GS} = 10V V _{DD} = 400V I _D = 77A @ 25°C		260		nC
Q _{gs}	Gate-Source Charge			38		
Q _{gd}	Gate-Drain ("Miller") Charge			144		
t _{d(on)}	Turn-on Delay Time	INDUCTIVE SWITCHING V _{GS} = 10V V _{DD} = 380V I _D = 77A @ 25°C R _G = 5.0Ω		18		ns
t _r	Rise Time			27		
t _{d(off)}	Turn-off Delay Time			110	165	
t _f	Fall Time			8	12	
E _{on}	Turn-on Switching Energy ⁵	INDUCTIVE SWITCHING @ 25°C V _{DD} = 400V, V _{GS} = 15V I _D = 77A, R _G = 5Ω		1670		μJ
E _{off}	Turn-off Switching Energy			2880		
E _{on}	Turn-on Switching Energy ⁵	INDUCTIVE SWITCHING @ 125°C V _{DD} = 400V, V _{GS} = 15V I _D = 77A, R _G = 5Ω		2300		
E _{off}	Turn-off Switching Energy			3100		

SOURCE-DRAIN DIODE RATINGS AND CHARACTERISTICS

Symbol	Characteristic / Test Conditions	MIN	TYP	MAX	UNIT
I _S	Continuous Source Current (Body Diode)			77	Amps
I _{SM}	Pulsed Source Current ¹ (Body Diode)			231	
V _{SD}	Diode Forward Voltage ³ (V _{GS} = 0V, I _S = -77A)		1	1.2	Volts
dv/dt	Peak Diode Recovery ^{dv/dt} ⁶			15	V/ns
t _{rr}	Reverse Recovery Time (I _S = -77A, di/dt = 100A/μs)	T _J = 25°C		950	ns
Q _{rr}	Reverse Recovery Charge (I _S = -77A, di/dt = 100A/μs)	T _J = 25°C		32	μC
I _{RRM}	Peak Recovery Current (I _S = -77A, di/dt = 100A/μs)	T _J = 25°C		60	Amps

THERMAL CHARACTERISTICS

Symbol	Characteristic	MIN	TYP	MAX	UNIT
R _{θJC}	Junction to Case			0.26	°C/W
R _{θJA}	Junction to Ambient			40	

- 1 Repetitive Rating: Pulse width limited by maximum junction temperature
- 2 Repetitive avalanche causes additional power losses that can be calculated as $P_{AV} = E_{AR} \cdot f$. Pulse width tp limited by Tj max.
- 3 Pulse Test: Pulse width < 380 μs, Duty Cycle < 2%
- 4 See MIL-STD-750 Method 3471
- 5 Eon includes diode reverse recovery.
- 6 Maximum 125°C diode commutation speed = di/dt 600A/μs

Microsemi reserves the right to change, without notice, the specifications and information contained herein.

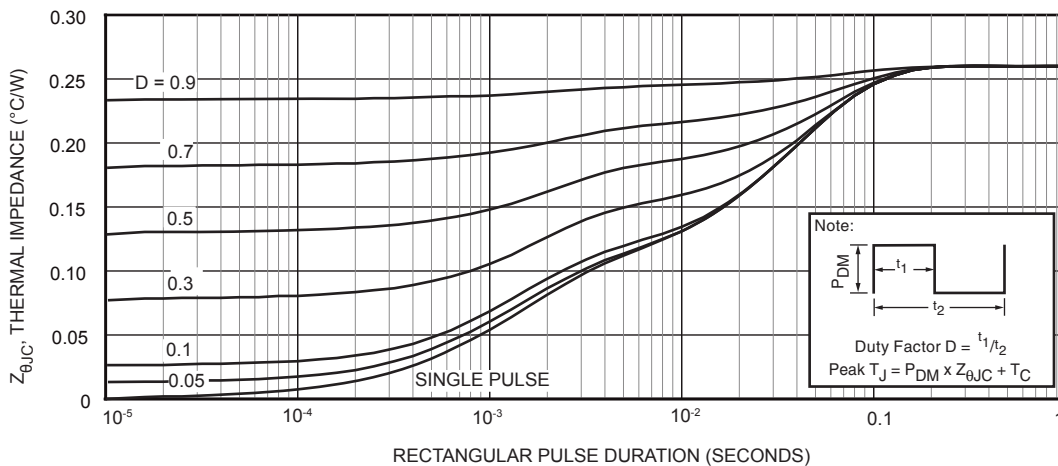

Figure 1, Maximum Effective Transient Thermal Impedance, Junction-To-Case vs Pulse Duration

Typical Performance Curves

APT77N60B_SC6

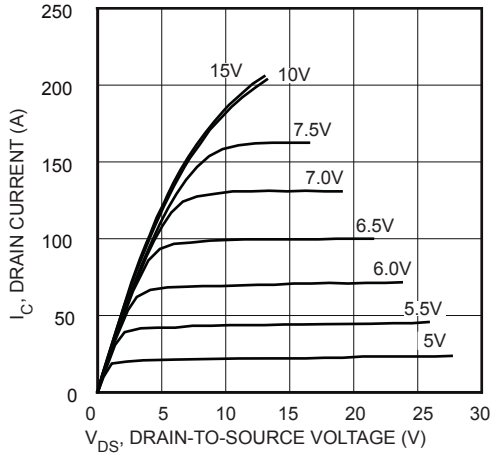

FIGURE 2, Low Voltage Output Characteristics

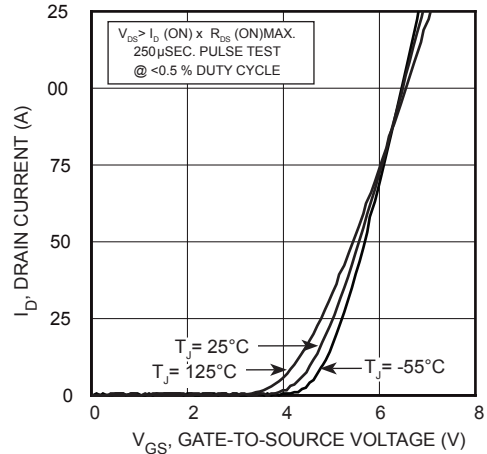

FIGURE 3, Transfer Characteristics

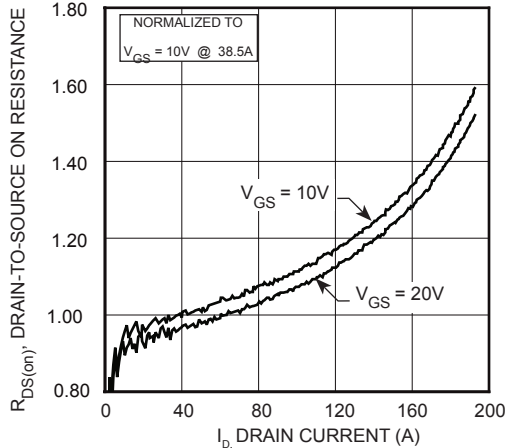

FIGURE 4, $R_{DS(ON)}$ vs Drain Current

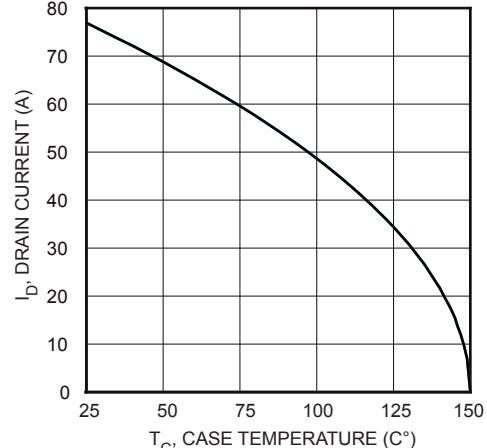

FIGURE 5, Maximum Drain Current vs Case Temperature

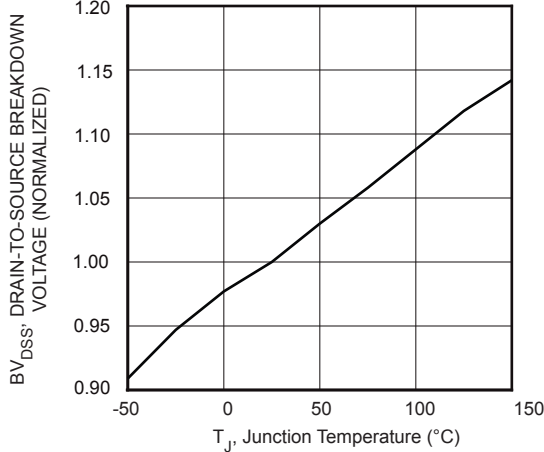

FIGURE 6, Breakdown Voltage vs Temperature

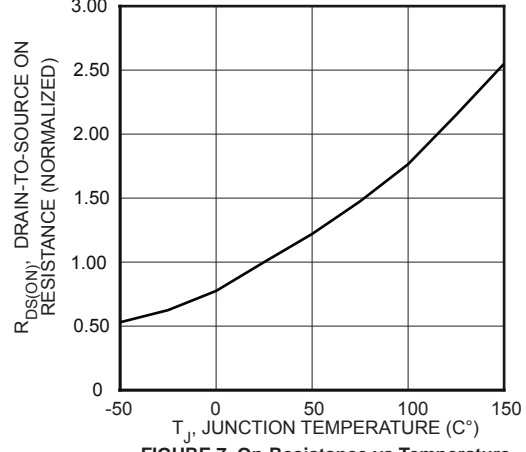

FIGURE 7, On-Resistance vs Temperature

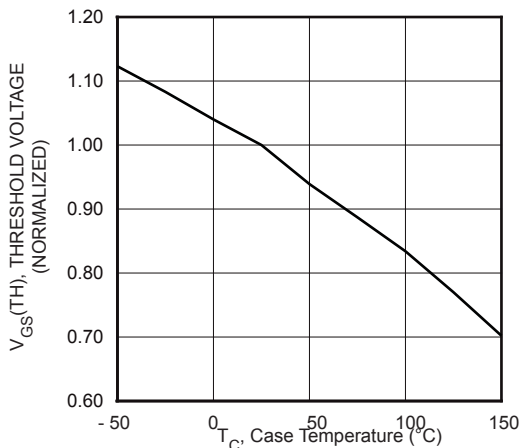

FIGURE 8, Threshold Voltage vs Temperature

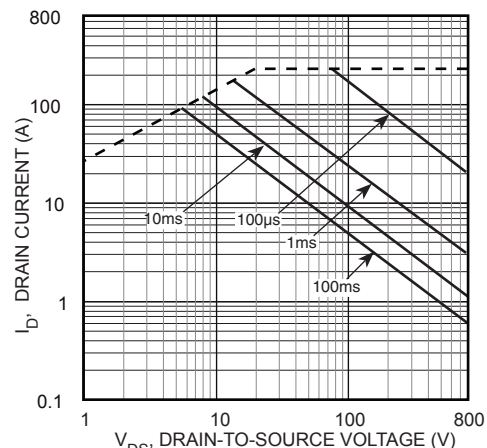

FIGURE 9, Maximum Safe Operating Area

Typical Performance Curves

APT77N60B_SC6

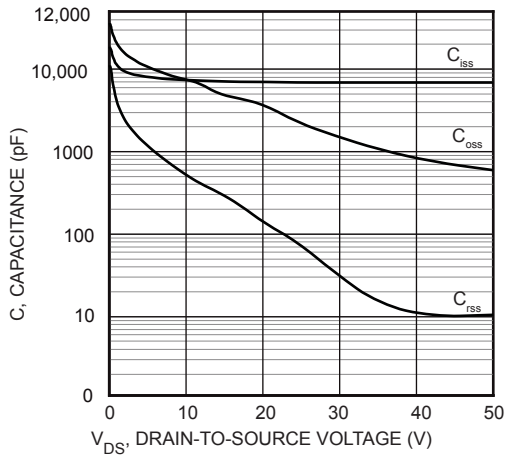

FIGURE 10, Capacitance vs Drain-To-Source Voltage

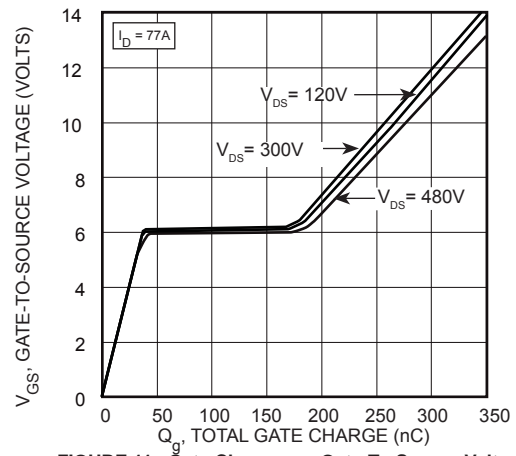

FIGURE 11, Gate Charges vs Gate-To-Source Voltage

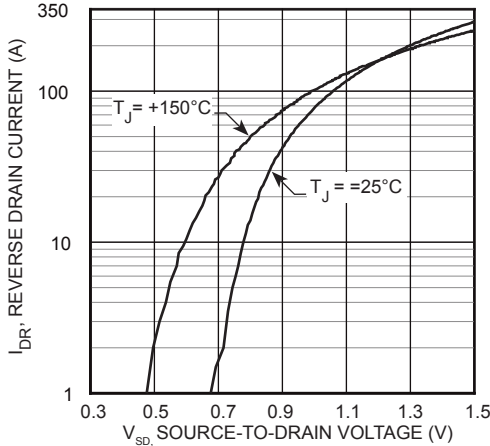

FIGURE 12, Source-Drain Diode Forward Voltage

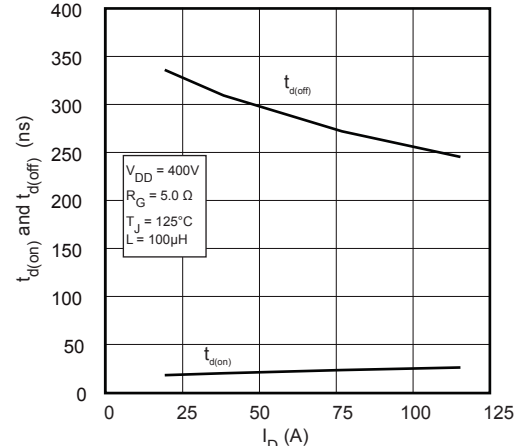

FIGURE 13, Delay Times vs Current

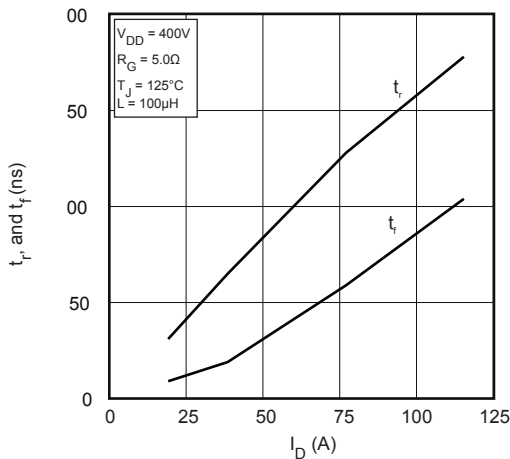

FIGURE 14, Rise and Fall Times vs Current

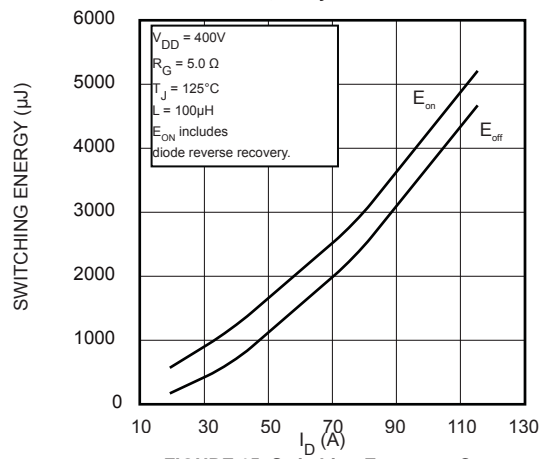

FIGURE 15, Switching Energy vs Current

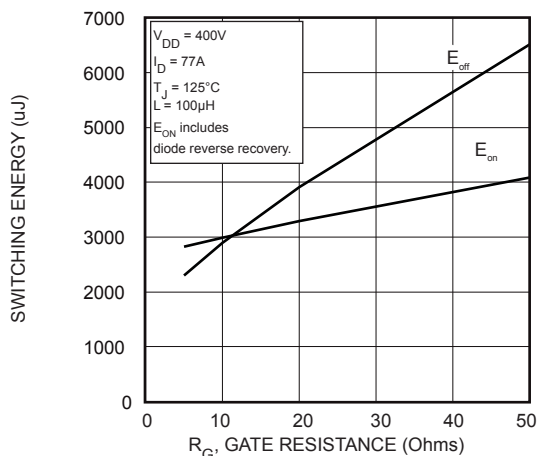

FIGURE 16, Switching Energy vs Gate Resistance

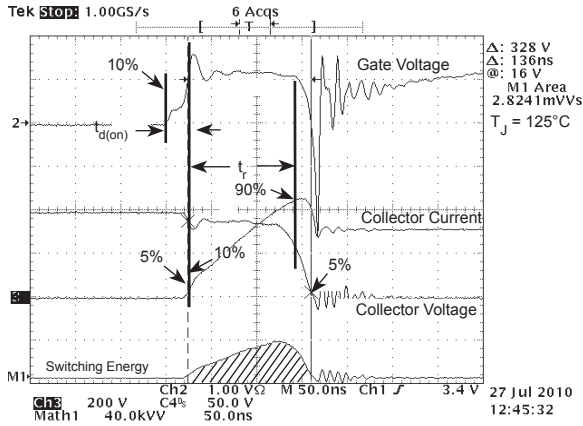

Figure 17, Turn-on Switching Waveforms and Definitions

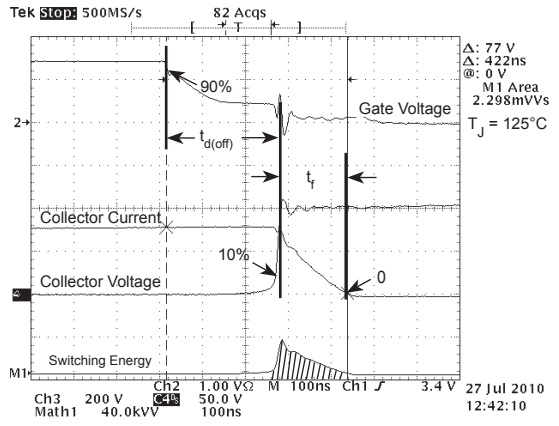

Figure 18, Turn-off Switching Waveforms and Definitions

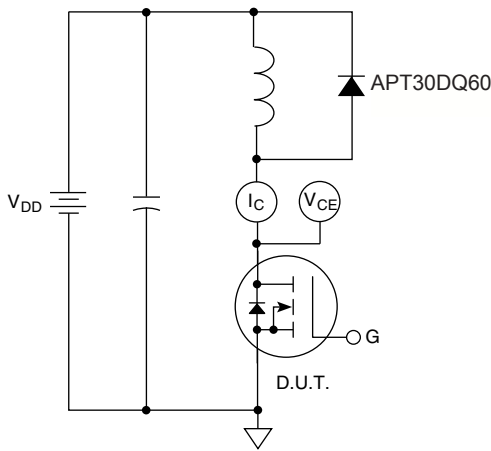
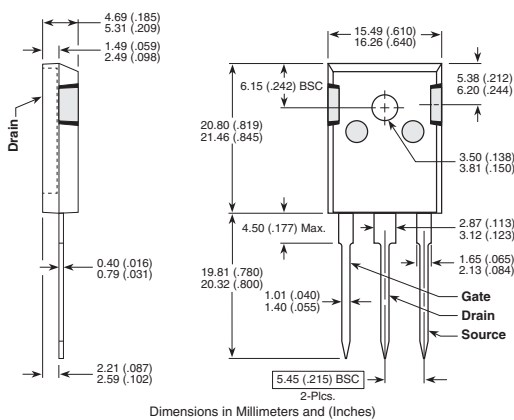

Figure 19, Inductive Switching Test Circuit

TO-247 Package Outline

ⓔ SAC: Tin, Silver, Copper



D³PAK Package Outline

ⓔ 100% Sn

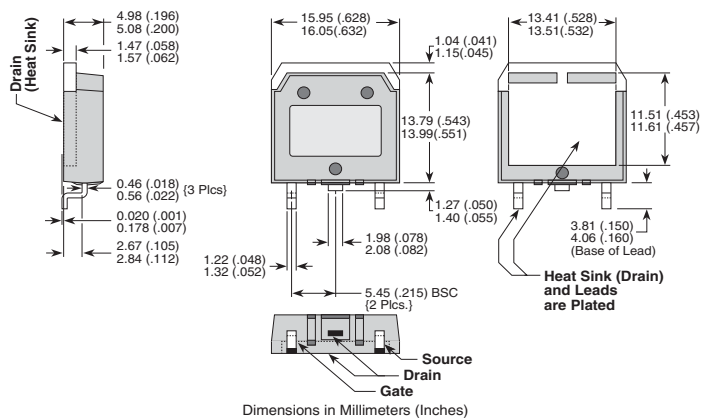

Microsemi's products are covered by one or more of U.S. patents 4,895,810 5,045,903 5,089,434 5,182,234 5,019,522 5,262,336 6,503,786 5,256,583 4,748,103 5,283,202 5,231,474 5,434,095 5,528,058 6,939,743, 7,352,045 5,283,201 5,801,417 5,648,283 7,196,634 6,664,594 7,157,886 6,939,743 7,342,262 and foreign patents. US and Foreign patents pending. All Rights Reserved.