

### Applications

- IF Amplifier
- VHF / UHF Transmission
- Wireless Infrastructure
- CATV / SATV / MoCA
- General Purpose Wireless

### Product Features

- 50 Ohm Cascadable Gain Block
- 50 – 1000 MHz
- 19.5 dB Gain at 200 MHz
- +20.5 dBm P1dB at 200 MHz
- +43.5 dBm Output IP3 at 200 MHz
- +60 dBm Output IP2 at 200 MHz
- Single +5 V Supply, 95 mA Current
- Robust 1000 V ESD, Class 1C
- SOT-89 Package

### General Description

The WJA1500 is a cascadable gain block that offers high linearity in a low-cost surface-mount package. At 200 MHz, the WJA1500 typically provides 19.5 dB gain, +43.5 dBm OIP3, and +20.5 dBm P1dB. The device is housed in a RoHS-compliant SOT-89 industry-standard SMT package using Annealed Matte Tin or NiPdAu plating to reduce or eliminate the possibility of tin whiskers.

The WJA1500 consists of Darlington pair amplifiers using a high reliability InGaP / GaAs HBT process technology. The MMIC amplifier is internally matched to 50 Ω and only requires DC-blocking capacitors and a bias inductor for operation. An internal active bias is designed to enable stable performance over temperature. A dropping bias resistor is not required allowing the device to be biased directly from +5 V supply voltage.

The amplifier is targeted for high performance IF applications in existing and next generation wireless technologies. The WJA1500 is ideal for general purpose applications such as LO buffering, IF amplification and pre-driver stages within the 50 to 1000 MHz frequency range.



SOT-89 Package

### Functional Block Diagram

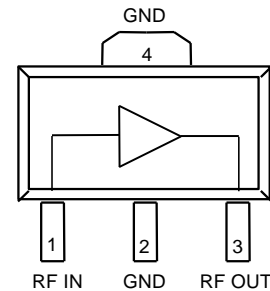

### Pin Configuration

Pin No.	Label
1	RF IN
3	RF OUT
2, 4	GND

### Ordering Information

Part No.	Description
WJA1500	1,000 pieces on a 7" reel (standard)
WJA1500-PCB	50 – 1000 MHz Evaluation Board

### Absolute Maximum Ratings

Parameter	Rating
Storage Temperature	-55 to 150 °C
RF Input Power, CW, 50 Ω, T=25 °C	+24 dBm
Supply Voltage	+6.5 V

Operation of this device outside the parameter ranges given above may cause permanent damage.

### Recommended Operating Conditions

Parameter	Min	Typ	Max	Units
V <sub>CC</sub>	+4.75	+5	+5.25	V
T <sub>CASE</sub>	-40		+85	°C
T <sub>j</sub> for >10 <sup>6</sup> hours MTTF			+150	°C

Electrical specifications are measured at specified test conditions. Specifications are not guaranteed over all recommended operating conditions.

### Electrical Specifications

Test conditions unless otherwise noted: V<sub>SUPPLY</sub> = +5 V, T<sub>CASE</sub> = +25 °C, 50 Ω system

Parameter	Conditions	Min	Typ	Max	Units
Operational Frequency Range		50		1000	MHz
Test Frequency			200		MHz
Gain		17.8	19.4	20.8	dB
Input Return Loss			17		dB
Output Return Loss			21		dB
Output P1dB			+20.5		dBm
Output IP3	P <sub>out</sub> =+8 dBm/tone, Δf= 1 MHz	+39	+43.7		dBm
Output IP2			+59.8		dBm
Noise Figure			5.0		dB
Device Current, (I <sub>CC</sub> )		79	95	99	mA
Thermal Resistance, (θ <sub>jc</sub> )	Junction to case <sup>(1)</sup>			78	°C/W

Notes:

1. Thermal path is from the device junction through the package ground tab (pins 2, 4) to the backside mounting surface.

### S-Parameters

Test Conditions:  $V_{SUPPLY}=+5\text{ V}$ ,  $I_{CC}=94\text{ mA}$  (typ.),  $T_{CASE}=+25\text{ }^{\circ}\text{C}$ , fixture measurement, calibrated to device leads

Freq (MHz)	S11 (dB)	S11 (ang)	S21 (dB)	S21 (ang)	S12 (dB)	S12 (ang)	S22 (dB)	S22 (ang)
10	-15.69	-55.09	21.82	171.35	-25.19	11.61	-10.46	-28.13
50	-17.40	-135.23	19.98	168.76	-23.20	4.28	-18.29	-60.10
100	-17.59	-153.75	19.68	167.63	-23.05	0.79	-21.02	-64.45
150	-17.77	-158.44	19.59	164.26	-22.99	-1.17	-21.22	-67.20
200	-17.56	-160.17	19.47	160.44	-22.96	-2.89	-21.01	-73.21
250	-17.54	-160.17	19.42	157.05	-22.91	-4.24	-20.25	-76.35
300	-17.25	-159.36	19.36	153.10	-23.00	-5.88	-19.36	-80.46
350	-17.04	-156.92	19.33	148.71	-22.99	-6.83	-18.55	-83.44
400	-16.88	-156.28	19.26	144.56	-22.97	-8.61	-17.94	-86.00
450	-16.50	-152.39	19.19	140.90	-23.01	-9.69	-16.95	-90.06
500	-16.25	-152.53	19.10	136.81	-22.93	-10.49	-16.62	-92.43
550	-16.04	-151.61	19.01	132.74	-23.00	-12.61	-15.94	-96.08
600	-15.71	-149.87	18.90	128.80	-23.02	-13.57	-15.45	-98.43
650	-15.45	-147.51	18.80	124.94	-23.01	-14.81	-14.87	-101.00
700	-15.11	-146.25	18.69	120.76	-23.04	-15.97	-14.15	-104.13
750	-14.84	-144.74	18.58	117.69	-23.01	-17.76	-13.71	-106.18
800	-14.67	-144.80	18.45	113.29	-23.00	-19.31	-13.28	-108.81
850	-14.45	-143.29	18.38	109.27	-23.05	-19.69	-12.67	-111.55
900	-14.25	-141.96	18.20	105.66	-23.02	-21.32	-12.12	-114.03
950	-14.05	-141.12	18.16	101.96	-23.09	-22.91	-11.61	-116.73
1000	-13.98	-140.85	18.02	97.92	-23.14	-23.65	-11.22	-119.37
1050	-13.75	-140.40	17.84	94.26	-23.06	-24.91	-10.74	-121.30
1100	-13.40	-139.62	17.69	90.54	-23.10	-26.92	-10.34	-123.81
1150	-13.24	-138.81	17.60	86.83	-23.10	-28.23	-9.89	-125.85
1200	-13.05	-138.36	17.43	82.58	-23.24	-29.00	-9.59	-128.24

Device S-parameters are available for download on the WJA1500 product page at [www.qorvo.com](http://www.qorvo.com)

### WJA1500-PCB Evaluation Board

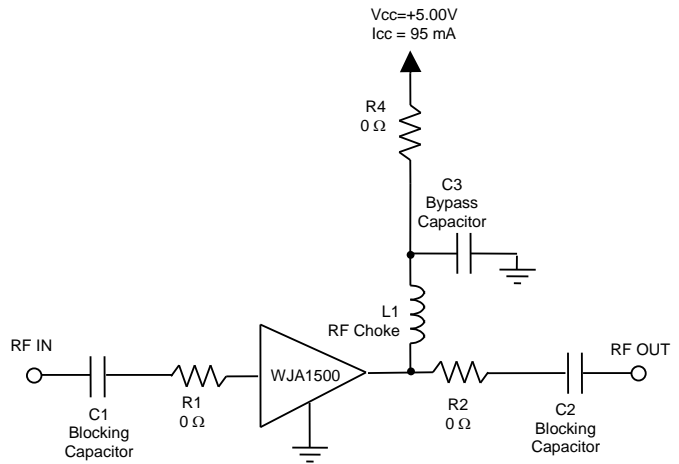
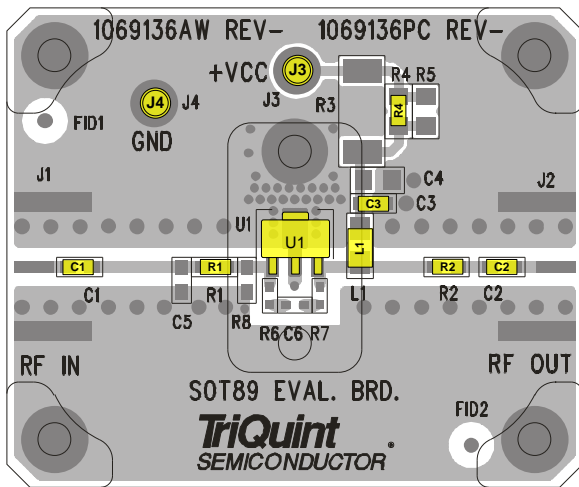

**Notes:**

1. See Evaluation Board PCB Information section for material and stack-up.
2. All components are of 0603 size unless otherwise stated.

### Bill of Material – WJA1500-PCB

Reference Des.	Value	Description	Manuf.	Part Number
U1	n/a	InGaP HBT Gain Block	Qorvo	WJA1500
L1	470 nH	Ferrite core wire wound inductor, 0805 <sup>(1)</sup>	various	
C1, C2	1000 pF	Cap, Chip, 0603, 50V, NPO, 5%	various	
C3	0.018 μF	Cap, Chip, 0603, 16V, X7R, 10%	Coilcraft	
R1, R2, R4	0 Ω	Res, Chip, 0603, 1/10W, 5%	various	

**Notes:**

1. For lower cost and performance (100 – 1000 MHz) option use 470 nH air core wire wound inductor.
2. R1, R2, and R4 may be replaced by copper trace in end user applications.

### Typical Performance - WJA1500-PCB

Test conditions unless otherwise stated:  $V_{SUPPLY} = +5V$ ,  $I_{CC} = 94mA$  (typ.),  $T_{CASE} = +25^{\circ}C$

Parameter	Typical Value					Units
Frequency	70	170	240	500	900	MHz
Gain	19.6	19.3	19.2	18.8	17.6	dB
Input Return Loss	14	16	17	17	14	dB
Output Return Loss	25	27	22	15	10	dB
Output P1dB	+20.2	+20.3	+20.4	+20.4	+19.9	dBm
Output IP3 <sup>(1)</sup>	+42.1	+44.6	+43.8	+38.3	+33.4	dBm
Output IP2	+63.2	+61.1	+58.0	+59.0	+52.0	dBm
Noise Figure	4.9	4.9	5.0	5.2	5.8	dB

**Notes:**

1. OIP3 measured with two tones at an output power of +8 dBm / tone separated by 1 MHz.

### Performance Plots – WJA1500-PCB

Test conditions unless otherwise stated:  $V_{SUPPLY}=+5\text{ V}$ ,  $I_{CC}=94\text{ mA}$  (typ.),  $T_{CASE}=+25\text{ }^{\circ}\text{C}$

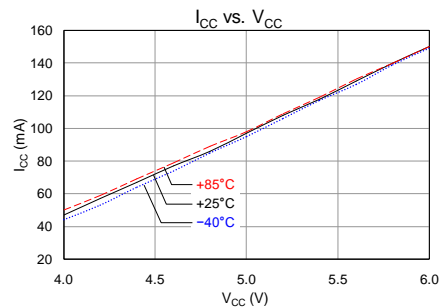
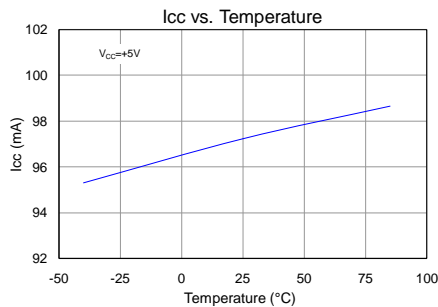
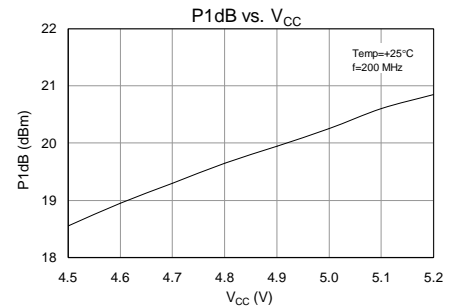
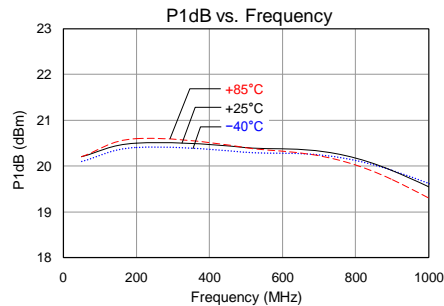
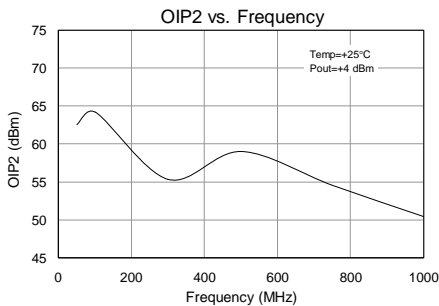
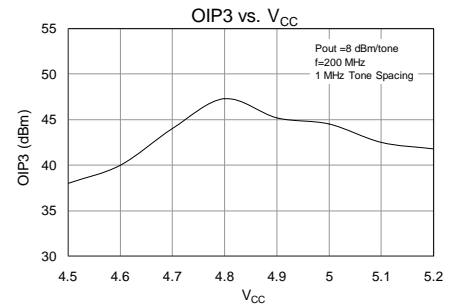
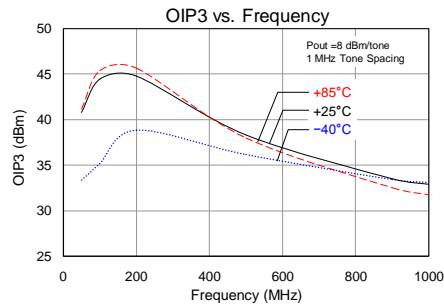
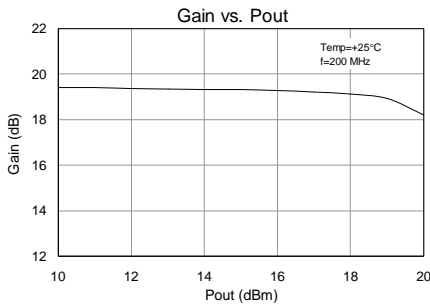
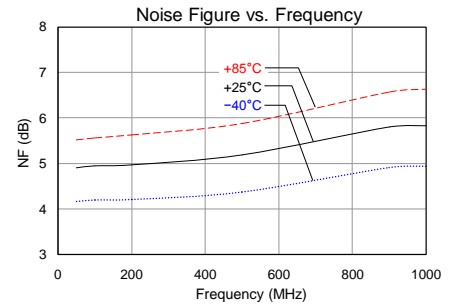
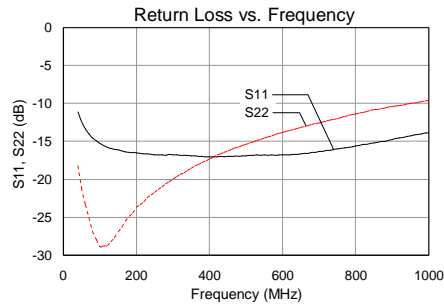
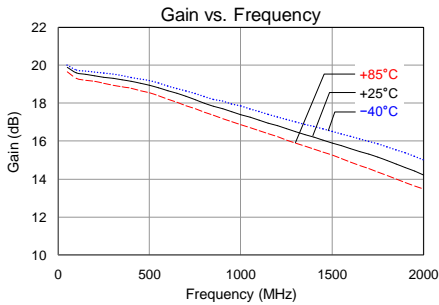

### Pin Configuration and Description

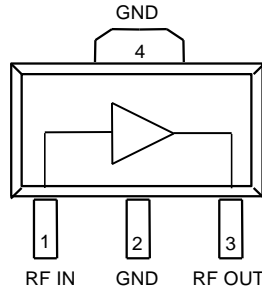

Pin No.	Label	Description
1	RF IN	RF input, matched to 50 ohms. External DC Block is required.
3	RF OUT	RF output / DC supply, matched to 50 ohms. External DC Block, RF choke required.
2, 4	GND	Ground and Backside Paddle. Multiple via holes should be employed to minimize inductance and thermal resistance; see PCB mounting pattern in Mechanical Information section.

### Evaluation Board PCB Information

PCB 1069136 Material and Stack-up

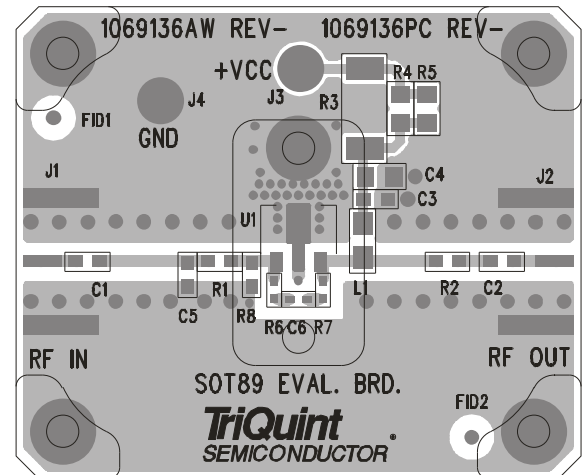
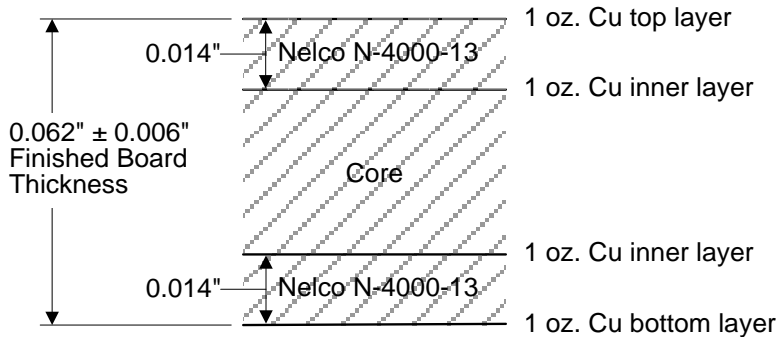

### Package Marking and Dimensions

Marking:  
 Part Number – A1500  
 Trace Code – XXXX

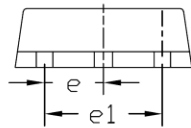
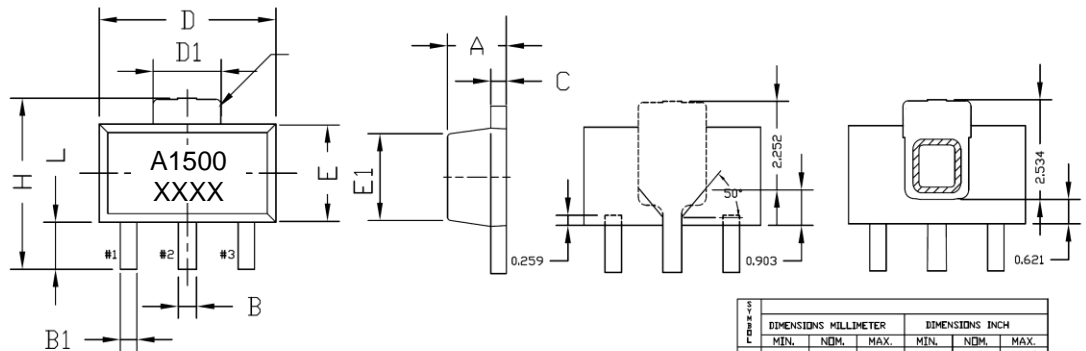

NOTES :  
 1. DIMENSIONING & TOLERANCING PER ANSI Y14.5M-1982  
 2. CONTROLLING DIMENSION : MILLIMETER CONVERTED INCH ARE NOT NECESSARILY EXACT.  
 3. DIMENSION B1, 2 PLACES.

DIM.	DIMENSIONS MILLIMETER			DIMENSIONS INCH		
	MIN.	NOM.	MAX.	MIN.	NOM.	MAX.
A	1.40	1.50	1.60	0.055	0.059	0.063
B	0.42	0.49	0.56	0.017	0.019	0.022
B1	0.36	0.42	0.44	0.014	0.016	0.019
C	0.35	0.40	0.43	0.014	0.016	0.017
D	4.39	4.50	4.60	0.173	0.177	0.181
D1	1.40	1.62	1.83	0.055	0.062	0.072
E	2.29	2.44	2.60	0.090	0.098	0.102
E1	1.77	2.03	2.29	0.070	0.074	0.090
e	1.50 BSC			0.059 BSC		
e1	3.00 BSC			0.118 BSC		
H	3.84	4.04	4.25	0.151	0.155	0.167
L	0.74	0.97	1.20	0.029	0.041	0.047

**Notes:**

1. All dimensions are in millimeters. Angles are in degrees.
2. The terminal #1 identifier and terminal numbering conform to JESD 95-1 SPP-012.
3. Trace Code up to 4 digits assigned by sub-contractor

### PCB Mounting Pattern

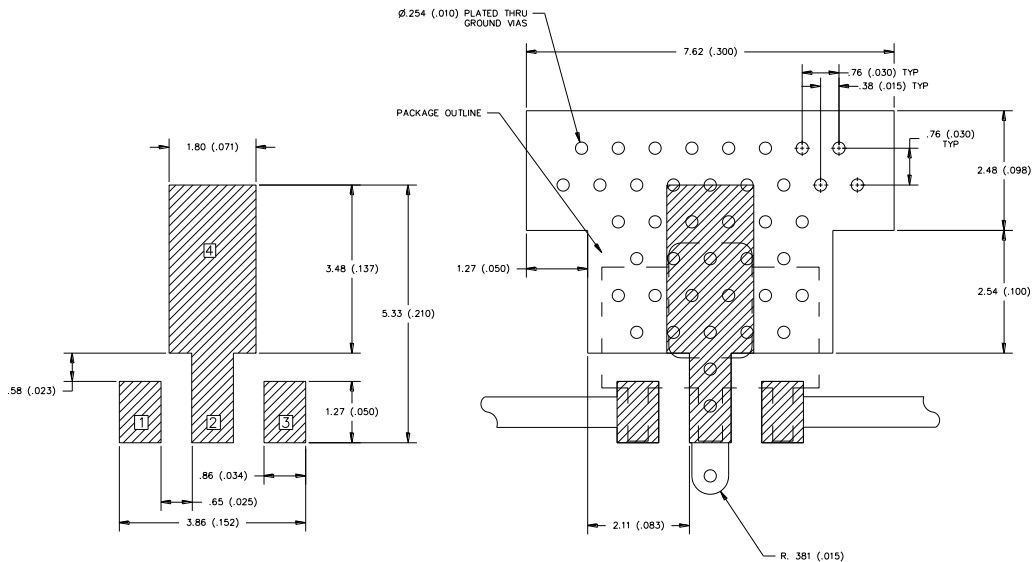

**Notes:**

1. All dimensions are in millimeters. Angles are in degrees.
2. Use 1 oz. copper minimum for top and bottom layer metal.
3. Via holes are required under the backside paddle of this device for proper RF/DC grounding and thermal conductivity.
4. Do not remove or minimize via hole structure in the PCB. Thermal and RF grounding is critical.
5. We recommend a 0.35mm (#80/.0135") diameter bit for drilling via holes and a final plated thru diameter of 0.25 mm (0.10").
6. Ensure good package backside paddle solder attach for reliable operation and best electrical performance.

### Product Compliance Information

#### ESD Sensitivity Ratings



Caution! ESD-Sensitive Device

ESD Rating: Class 1C  
Value:  $\geq 1000\text{ V}$  and  $< 2000\text{ V}$   
Test: Human Body Model (HBM)  
Standard: JEDEC Standard JS-001-2012

ESD Rating: Class C3  
Value:  $\geq 1000\text{ V}$   
Test: Charged Device Model (CDM)  
Standard: JEDEC Standard JESD22-C101F

#### MSL Rating

MSL Rating: Level 3 or better  
Test:  $260\text{ }^\circ\text{C}$  convection reflow  
Standard: JEDEC Standard IPC/JEDEC J-STD-020

#### Solderability

Compatible with both lead-free ( $260\text{ }^\circ\text{C}$  maximum reflow temperature) and tin/lead ( $245\text{ }^\circ\text{C}$  maximum reflow temperature) soldering processes.

Contact plating: Annealed Matte Tin or NiPdAu

#### RoHS Compliance

This part is compliant with EU 2002/95/EC RoHS directive (Restrictions on the Use of Certain Hazardous Substances in Electrical and Electronic Equipment).

This product also has the following attributes:

- Lead Free
- Halogen Free (Chlorine, Bromine)
- Antimony Free
- TBBP-A ( $\text{C}_{15}\text{H}_{12}\text{Br}_4\text{O}_2$ ) Free
- PFOS Free
- SVHC Free

### Contact Information

For the latest specifications, additional product information, worldwide sales and distribution locations:

Web: [www.qorvo.com](http://www.qorvo.com)      Tel: +1-844-890-8163  
Email: [customer.support@qorvo.com](mailto:customer.support@qorvo.com)

For technical questions and application information:

Email: [appsupport@qorvo.com](mailto:appsupport@qorvo.com)

### Important Notice

The information contained herein is believed to be reliable; however, Qorvo makes no warranties regarding the information contained herein and assumes no responsibility or liability whatsoever for the use of the information contained herein. All information contained herein is subject to change without notice. Customers should obtain and verify the latest relevant information before placing orders for Qorvo products. The information contained herein or any use of such information does not grant, explicitly or implicitly, to any party any patent rights, licenses, or any other intellectual property rights, whether with regard to such information itself or anything described by such information. **THIS INFORMATION DOES NOT CONSTITUTE A WARRANTY WITH RESPECT TO THE PRODUCTS DESCRIBED HEREIN, AND QORVO HEREBY DISCLAIMS ANY AND ALL WARRANTIES WITH RESPECT TO SUCH PRODUCTS WHETHER EXPRESS OR IMPLIED BY LAW, COURSE OF DEALING, COURSE OF PERFORMANCE, USAGE OF TRADE OR OTHERWISE, INCLUDING THE IMPLIED WARRANTIES OF MERCHANTABILITY AND FITNESS FOR A PARTICULAR PURPOSE.**

Without limiting the generality of the foregoing, Qorvo products are not warranted or authorized for use as critical components in medical, life-saving, or life-sustaining applications, or other applications where a failure would reasonably be expected to cause severe personal injury or death.

Copyright 2017 © Qorvo, Inc. | Qorvo is a registered trademark of Qorvo, Inc.