



This document is the property of and embodies  
 CONFIDENTIAL and PROPRIETARY information of FCI.  
 No part of the information shown on this  
 document may be used in any way or disclosed  
 to others without the written consent of FCI.  
 Copyright FCI.

PRODUCT NUMBER	PLATING PERFORMANCE LEVEL	FOR REAR PLUG-UP APPLICATIONS USE SHROUD
63784-1YYY	TELCORDIA CO	74993-102
63784-1YYLFF	TELCORDIA CO	84625-102LFF
63784-5YYY	TELCORDIA UE	74993-502
63784-5YYLFF	TELCORDIA UE	84625-502LFF
63784-9YYY	TELCORDIA CO	74993-102
63784-9YYLFF	TELCORDIA CO	84625-102LFF
63784-AYYY	CUSTOMER SPECIAL	74993-102
63784-AYYLFF	CUSTOMER SPECIAL	84625-102LFF



DETAIL A  
SCALE 4:1  
SEE NOTE 16

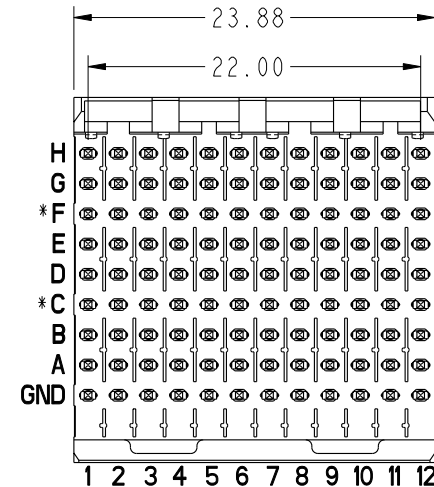
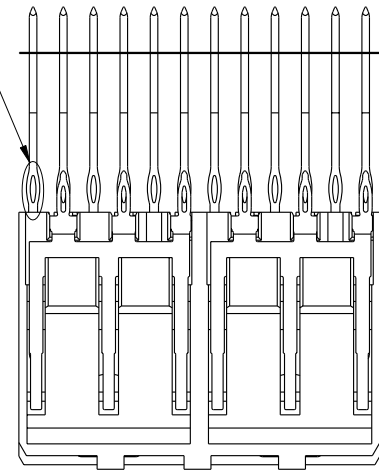

mat'l code SEE NOTE 5				tolerances unless otherwise specified				CUSTOMER			FCI www.fciconnect.com	
ltr	ecm no.	dr	date	linear	0.X ±0.3			COPY			title VERTICAL SIGNAL HDR 8 ROW P.F. 96 POS. SELECT LOAD EXT.	
AH	V06-0498	DCH	2006-05-30		0.XX ±0.13			projection				
AJ	V07-0169	DCH	2007-03-27	angles	.XXX ±.051			MM			product family METRAL 1000 code size dwg no 213	
AK	V08-0016	HTB	2008-01-10		0° ±2°			←→				
AL	V08-0051	LP	2008-02-19	dr	E. KROPER.	2001-01-10	scale			A 63784	sheet 1 of 10	
-	-	-	-	enrg	J. VOLSTORF	2001-01-10	1:1					
AF	V05-1022	LP	2005-11-08	chr	J. VOLSTORF	2001-01-10	A			cage code 22526	4	
AG	V05-1125	LP	2005-12-19	appd	J. VOLSTORF	2001-01-10	A					
sheet index	revision sheet	AL	AL	AL	AL	AL	AL	AL	AL	AL		

PIN NO.	DIM A MATING LENGTH	DIM B TAIL LENGTH	PCB THICKNESS RANGE ACCOMMODATED BY PIN'S TAIL LENGTH				
			WHEN MATING TO A 74981 SERIES RECEPTACLE		WHEN MATING TO A 52066 SERIES METRAL 4000 RECEPTACLE		
			ROWS A,B, C,D,E,F,G & H	GROUND ROW	ROWS:A,B, D,E,G & H	ROW C & F	GROUND ROW
01*	5.00	4.30	1.60 MIN	1.60 MIN	1.60 MIN	1.60 MIN	1.60 MIN
22		12.20	2.95 - 3.80	2.95 - 4.20	2.95 - 3.80	2.95 - 3.80	2.95 - 4.20
30		12.95	2.95 - 4.55	3.25 - 4.95	2.95 - 4.55	2.95 - 4.55	3.25 - 4.95
05		13.70	2.95 - 5.30	4.00 - 5.70	3.30 - 5.30	2.95 - 5.30	4.00 - 5.70
35		14.45	3.05 - 6.05	4.75 - 6.45	4.05 - 6.05	3.05 - 6.05	4.75 - 6.45
48		15.20	3.80 - 6.80	5.50 - 7.20	4.80 - 6.80	3.80 - 6.80	5.50 - 7.20
40		15.70	4.30 - 7.30	6.00 - 7.70	5.30 - 7.30	4.30 - 7.30	6.00 - 7.70
65		16.40	5.00 - 8.00	6.70 - 8.40	6.00 - 8.00	5.00 - 8.00	6.70 - 8.40
09		17.10	5.70 - 8.70	7.40 - 9.10	6.70 - 8.70	5.70 - 8.70	7.40 - 9.10
02*	5.75	4.30	1.60 MIN	1.60 MIN	1.60 MIN	1.60 MIN	1.60 MIN
44		12.20	2.95 - 3.80	2.95 - 4.20	2.95 - 3.80	2.95 - 3.80	2.95 - 4.20
31		12.95	2.95 - 4.55	3.25 - 4.95	2.95 - 4.55	2.95 - 4.55	3.25 - 4.95
06		13.70	2.95 - 5.30	4.00 - 5.70	3.30 - 5.30	2.95 - 5.30	4.00 - 5.70
36		14.45	3.05 - 6.05	4.75 - 6.45	4.05 - 6.05	3.05 - 6.05	4.75 - 6.45
49		15.20	3.80 - 6.80	5.50 - 7.20	4.80 - 6.80	3.80 - 6.80	5.50 - 7.20
25		15.70	4.30 - 7.30	6.00 - 7.70	5.30 - 7.30	4.30 - 7.30	6.00 - 7.70
66		16.40	5.00 - 8.00	6.70 - 8.40	6.00 - 8.00	5.00 - 8.00	6.70 - 8.40
10		17.10	5.70 - 8.70	7.40 - 9.10	6.70 - 8.70	5.70 - 8.70	7.40 - 9.10
03*	6.50	4.30	1.60 MIN	1.60 MIN	1.60 MIN	1.60 MIN	1.60 MIN
45		12.20	2.95 - 3.80	2.95 - 4.20	2.95 - 3.80	2.95 - 3.80	2.95 - 4.20
32		12.95	2.95 - 4.55	3.25 - 4.95	2.95 - 4.55	2.95 - 4.55	3.25 - 4.95
07		13.70	2.95 - 5.30	4.00 - 5.70	3.30 - 5.30	2.95 - 5.30	4.00 - 5.70
37		14.45	3.05 - 6.05	4.75 - 6.45	4.05 - 6.05	3.05 - 6.05	4.75 - 6.45
50		15.20	3.80 - 6.80	5.50 - 7.20	4.80 - 6.80	3.80 - 6.80	5.50 - 7.20
41		15.70	4.30 - 7.30	6.00 - 7.70	5.30 - 7.30	4.30 - 7.30	6.00 - 7.70
24		16.40	5.00 - 8.00	6.70 - 8.40	6.00 - 8.00	5.00 - 8.00	6.70 - 8.40
11		17.10	5.70 - 8.70	7.40 - 9.10	6.70 - 8.70	5.70 - 8.70	7.40 - 9.10



This document is the property of and embodies CONFIDENTIAL and PROPRIETARY information of FCI. No part of the information shown on this document may be used in any way or disclosed to others without the written consent of FCI. Copyright FCI.

mat'l code SEE NOTE 5				tolerances unless otherwise specified		CUSTOMER	FCI www.fciconnect.com		
ltr	ecn no.	dr	date	linear	0.X ±0.3	projection	COPY		
AL					0.XX ±0.13		title		
					.XXX ±.051		VERTICAL SIGNAL HDR 8 ROW		
				angles	0° ±2°		P.F. 96 POS. SELECT LOAD EXT.		
				dr	E. KROPER. 2001-01-10		MM	product family	METRAL 1000
				engr	J. VOLSTORF 2001-01-10			code	213
				chr	J. VOLSTORF 2001-01-10	size		dwg no	63784
				appd	J. VOLSTORF 2001-01-10	scale	A	sheet	2
sheet index	revision sheet								

PIN NO.	DIM A MATING LENGTH	DIM B TAIL LENGTH	PCB THICKNESS RANGE ACCOMMODATED BY PIN LENGTH				
			WHEN MATING TO A 74981 SERIES RECEPTACLE		WHEN MATING TO A 52066 SERIES METRAL 4000 RECEPTACLE		
			ROWS A,B,C, D,E,F,G & H	GROUND ROW	ROWS:A,B, D,E,G & H	ROW C & F	GROUND ROW
04*	7.25	4.30	1.60 MIN	1.60 MIN	1.60 MIN	1.60 MIN	1.60 MIN
46		12.20	2.95 - 3.80	2.95 - 4.20	2.95 - 3.80	2.95 - 3.80	2.95 - 4.20
33		12.95	2.95 - 4.55	3.25 - 4.95	2.95 - 4.55	2.95 - 4.55	3.25 - 4.95
08		13.70	2.95 - 5.30	4.00 - 5.70	3.30 - 5.30	2.95 - 5.30	4.00 - 5.70
38		14.45	3.05 - 6.05	4.75 - 6.45	4.05 - 6.05	3.05 - 6.05	4.75 - 6.45
51		15.20	3.80 - 6.80	5.50 - 7.20	4.80 - 6.80	3.80 - 6.80	5.50 - 7.20
42		15.70	4.30 - 7.30	6.00 - 7.70	5.30 - 7.30	4.30 - 7.30	6.00 - 7.70
67		16.40	5.00 - 8.00	6.70 - 8.40	6.00 - 8.00	5.00 - 8.00	6.70 - 8.40
12		17.10	5.70 - 8.70	7.40 - 9.10	6.70 - 8.70	5.70 - 8.70	7.40 - 9.10
19*	8.00	4.30	1.60 MIN	1.60 MIN	1.60 MIN	1.60 MIN	1.60 MIN
47		12.20	2.95 - 3.80	2.95 - 4.20	2.95 - 3.80	2.95 - 3.80	2.95 - 4.20
34		12.95	2.95 - 4.55	3.25 - 4.95	2.95 - 4.55	2.95 - 4.55	3.25 - 4.95
20		13.70	2.95 - 5.30	4.00 - 5.70	3.30 - 5.30	2.95 - 5.30	4.00 - 5.70
39		14.45	3.05 - 6.05	4.75 - 6.45	4.05 - 6.05	3.05 - 6.05	4.75 - 6.45
52		15.20	3.80 - 6.80	5.50 - 7.20	4.80 - 6.80	3.80 - 6.80	5.50 - 7.20
43		15.70	4.30 - 7.30	6.00 - 7.70	5.30 - 7.30	4.30 - 7.30	6.00 - 7.70
68		16.40	5.00 - 8.00	6.70 - 8.40	6.00 - 8.00	5.00 - 8.00	6.70 - 8.40
21		17.10	5.70 - 8.70	7.40 - 9.10	6.70 - 8.70	5.70 - 8.70	7.40 - 9.10

A

A



This document is the property of and embodies CONFIDENTIAL and PROPRIETARY information of FCI. No part of the information shown on this document may be used in any way or disclosed to others without the written consent of FCI. Copyright FCI.

B

\* STUB PINS - NO REAR PLUG-UP

\*\* THE GREATEST RANGE OCCURS WHEN THE B DIMENSION OF PIN 'GND' IS ONE SIZE SHORTER THEN THE OTHER PINS.

mat'l code SEE NOTE 5				tolerances unless otherwise specified		CUSTOMER		www.fciconnect.com	
ltr	ecn no.	dr	date	linear	0.X ±0.3		COPY		title VERTICAL SIGNAL HDR 8 ROW P.F. 96 POS. SELECT LOAD EXT.
AL					0.XX ±0.13		projection		
					.XXX ±.051				
				angles	0° ±2°				product family METRAL 1000 code 213 size dwg no 63784 sheet 3
				dr	E. KROPER.	2001-01-10	MM		
				engr	J. VOLSTORF	2001-01-10			
				chr	J. VOLSTORF	2001-01-10	scale 1:1		
				appd	J. VOLSTORF	2001-01-10	A		
sheet index	revision sheet								cage code 22526

B

PRODUCT NUMBER  
SEE SHEET 1



PRESS-FIT HOLES *	OPTION 1
HOLE DIAMETER AFTER PLATING	$\varnothing 0.65-0.80$
DRILLED HOLE	$\varnothing 0.81-0.86$ ( $\varnothing 0.85$ DRILL)
COPPER PLATING	0.025 MIN
SnPb PLATING	0.005-0.015

\* SEE PRINT 58351 FOR  
ADDITIONAL PCB INFO.

mat'l code SEE NOTE 5				tolerances unless otherwise specified		CUSTOMER		FCJ www.fciconnect.com			
ltr	ecn no.	dr	date	linear	0.X $\pm 0.3$	COPY		projection	title VERTICAL SIGNAL HDR 8 ROW P.F. 96 POS. SELECT LOAD EXT.		
AL					0.XX $\pm 0.13$	MM				product family	code
					.XXX $\pm 0.051$	1:1				size	sheet
				angles	0° $\pm 2^\circ$	A		dwg no	4		
				dr	E. KROPER. 2001-01-10	scale		63784	213		
				engr	J. VOLSTORF 2001-01-10	A				4	
				chr	J. VOLSTORF 2001-01-10	A					
				appd	J. VOLSTORF 2001-01-10	A					
sheet index	revision sheet										

This document is the property of and embodies  
CONFIDENTIAL and PROPRIETARY information of FCJ.  
No part of the information shown on this  
document may be used in any way or disclosed  
to others without the written consent of FCJ.  
Copyright FCJ.

PRODUCT NUMBER  
SEE SHEET 1

NOTES:

1. SEE APPLICATION SPECIFICATION GS-20-010 FOR INFORMATION ON AVAILABLE TOOLING, CURCUIT BOARD DESIGN CONSIDERATIONS, REPAIR PROCEDURES AND PRODUCT OFFERINGS.
2. SEE FCI PUBLICATION 950511-028 FOR "ELECTRICAL PERFORMANCE DATA FOR DIFFERENTIAL APPLICATIONS."
3. SEE FCI PUBLICATION 950511-028 FOR "ELECTRICAL PERFORMANCE DATA FOR SINGLE-ENDED APPLICATION."
4. UNLESS OTHERWISE SPECIFIED, ALL DIMENSIONS AND TOLERANCES TOLERANCES ARE IN ACCORDANCE WITH ASME Y14.5M, 1994
5. HOUSING MATERIAL: LIQUID CRYSTAL POLYMER, 30% GLASS FILLED, FLAME RETARDANT PER UL 94-V0.  
PIN MATERIAL: PHOSPHER BRONZE  
GROUND SPRING MATERIAL: PHOSPHER BRONZE
6. PLATING INFORMATION: PLATING ON CONTACT AREA MEETS THE PERFORMANCE LEVELS SHOWN IN TABLE ON SHEET 1. PLATING ON "LF" TAILS IS Sn. PLATING ON ALL OTHER TAILS IS SnPb.
7. DIMENSIONAL RESTRICTIONS OF PINS IN HEADERS.  
FOR MATING WITH METRAL 1000 RECEPTACLES  
DIM A : 5.00mm MIN, 8.00mm MAX FOR ROWS A-H  
DIM A : 5.00mm MIN, 5.75mm MAX FOR ROW GND NEXT TO ROW A  
DIM C : 5.00mm MIN, 8.00mm MAX FOR ROWS A-H  
DIM C : 4.60mm MIN, 6.30mm MAX FOR ROW GND NEXT TO ROW A  
FOR MATING WITH METRAL 4000 RECEPTACLES  
DIM A : 5.00mm MIN, 6.50mm MAX FOR ROWS A, B, D, E, G & H  
DIM A : 5.00mm MIN, 8.00mm MAX FOR ROW C & F  
DIM A : 5.00mm MIN, 5.75mm MAX FOR ROW GND NEXT TO ROW A  
DIM C : 5.00mm MIN, 7.00mm MAX FOR ROWS A, B, D, E, G & H  
DIM C : 5.00mm MIN, 8.00mm MAX FOR ROW C & F  
DIM C : 4.60mm MIN, 6.30mm MAX FOR ROW GND NEXT TO ROW A
8. THE MIN PCB THICKNESS FOR REAR PLUG-UP APPLICATIONS IS 2.9mm SINCE THE COMPLIANT SECTIONS OF THE GROUND SPRING OF THE HEADER DIRECTLY OPPOSE THE GROUND SPRING OF THE SHROUD. THE MIN PCB THICKNESS FOR FRONT PLUG-UP ONLY APPLICATIONS IS 1.6mm.



9. THESE HOLES ARE NEEDED FOR REAR PLUG-UP DESIGNS USING A SHROUD AND MAY BE OMITTED FOR FRONT PLUG-UP ONLY DESIGNS.
10. THE 'CONNECTOR OUTLINE' IS THE MIN OUTLINE REQUIRED. TO DETERMINE THE OUTLINE NECESSARY TO PERMIT THE VARIOUS TYPES OF REPAIR OPERATIONS, SEE APPLICATION SPECIFICATION GS-20-010.
11. CURRENT RATING : 1 AMP PER PIN
12. TEMPERATURE RANGE : -55°C TO +105°C
13. P/N 63784-XXXXLF  

  - LEAD FREE (OPTIONAL)
  - SELECT LOAD PATTERN
  - PLATING CODE
14. AFTER INSERTION INTO CIRCUIT BOARD WITH QUALIFIED TOOL.
15. PRODUCTS WHERE THE PART NUMBER ENDS IN LF MEET EUROPEAN UNION DIRECTIVES AND OTHER COUNTRY REGULATIONS AS DESCRIBED IN GS-22-008.

ALL PRODUCTS WILL WITHSTAND EXPOSURE TO 260°C FOR 60 SECONDS IN A CONVECTION, INFRA-RED OR VAPOR PHASE REFLOW OVEN.

16. PIN TYPE IS AT THE MANUFACTURERS OPTION AND CAN BE EITHER BABY-H OR EYE OF THE NEEDLE STYLE

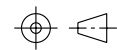

This document is the property of and embodies CONFIDENTIAL and PROPRIETARY information of FCI. No part of the information shown on this document may be used in any way or disclosed to others without the written consent of FCI. Copyright FCI.

mat'l code SEE NOTE 5				tolerances unless otherwise specified		CUSTOMER		 www.fciconnect.com	
ltr	ecm no.	dr	date	linear	0.X ±0.3	COPY		title VERTICAL SIGNAL HDR 8 ROW P.F. 96 POS. SELECT LOAD EXT.	
AL					0.XX ±0.13	projection			
					.XXX ±.051				
				angles	0° ±2°			product family METRAL 1000 code size dwg no 213 A 63784 sheet 5	
				dr	E. KROPER. 2001-01-10	scale			
				engr	J. VOLSTORF 2001-01-10	1:1			
				chr	J. VOLSTORF 2001-01-10				
				appd	J. VOLSTORF 2001-01-10				
sheet index	revision sheet								

cage code 22526



This document is the property of and embodies CONFIDENTIAL and PROPRIETARY information of FCI. No part of the information shown on this document may be used in any way or disclosed to others without the written consent of FCI. Copyright FCI.

1 | 2

METRAL P/N	ROW	CONTACT CODE											
		1	2	3	4	5	6	7	8	9	10	11	12
63784-X001  FOR LEAD FREE SEE NOTE 15	H	01	01	01	01	01	01	01	01	01	01	01	01
	G	01	01	01	01	01	01	01	03	03	03	01	19
	F	01	01	01	01	01	19	01	01	01	01	01	19
	E	01	01	01	01	01	19	01	03	03	03	01	19
	D	01	01	01	01	01	19	01	01	01	01	01	19
	C	01	01	01	01	01	19	01	01	01	01	01	19
	B	01	01	01	01	01	19	01	01	01	01	01	19
	A	01	01	01	01	01	01	01	01	01	01	01	19
	GND	01	01	01	01	01	01	01	01	01	01	01	01

CANNOT BE MATED TO A METRAL 4000 RECEPTACLE

METRAL P/N	ROW	CONTACT CODE											
		1	2	3	4	5	6	7	8	9	10	11	12
63784-X002 RPU  FOR LEAD FREE SEE NOTE 15	H	05	05	05	05	05	05	05	05	05	05	05	05
	G	05	05	05	05	05	05	05	05	05	05	05	05
	F	05	05	05	05	05	05	05	05	05	05	05	05
	E	05	05	05	05	05	05	05	05	05	05	05	05
	D	01	01	01	01	01	01	01	01	01	01	01	01
	C	01	01	01	01	01	01	01	01	01	01	01	01
	B	01	01	01	01	01	01	01	01	01	01	01	01
	A	01	01	01	01	01	01	01	01	01	01	01	01
	GND	01	01	01	01	01	01	01	01	01	01	01	01

FOR REAR PLUG UP APPLICATIONS, PCB THICKNESS RANGE: 2.95 -5.30 WHEN MATED TO METRAL 1000 RECEPT. AND 3.30-5.30 WHEN MATED TO METRAL 4000 RECEPT. (2.30 MIN IN NON-STANDARD REAR PLUG UP APPLICATIONS)

METRAL P/N	ROW	CONTACT CODE											
		1	2	3	4	5	6	7	8	9	10	11	12
63784-X003 RPU  FOR LEAD FREE SEE NOTE 15	H	01	01	01	01	01	01	01	01	01	01	01	01
	G	01	01	01	01	01	01	01	01	01	01	01	01
	F	01	01	01	01	01	01	01	01	01	01	01	01
	E	05	05	05	05	05	05	05	05	05	05	05	05
	D	05	05	05	05	05	05	05	05	05	05	05	05
	C	05	05	05	05	05	05	05	05	05	05	05	05
	B	05	05	05	05	05	05	05	05	05	05	05	05
	A	05	05	05	05	05	05	05	05	05	05	05	05
	GND	01	01	01	01	01	01	01	01	01	01	01	01

FOR REAR PLUG UP APPLICATIONS, PCB THICKNESS RANGE: 2.95 -5.30 WHEN MATED TO METRAL 1000 RECEPT. AND 3.30-5.30 WHEN MATED TO METRAL 4000 RECEPT. (2.30 MIN IN NON-STANDARD REAR PLUG UP APPLICATIONS)

METRAL P/N	ROW	CONTACT CODE											
		1	2	3	4	5	6	7	8	9	10	11	12
63784-X004  FOR LEAD FREE SEE NOTE 15	H	01	01	01	01	01	01	01	01	01	01	01	01
	G	01	01	01	01	01	01	03	03	03	03	01	19
	F	01	01	01	01	01	01	01	01	01	01	01	19
	E	01	01	01	01	01	01	03	03	03	03	01	19
	D	01	01	01	01	01	01	01	01	01	01	01	19
	C	01	01	01	01	01	01	01	01	01	01	01	19
	B	01	01	01	01	01	01	01	01	01	01	01	19
	A	01	01	01	01	01	01	01	01	01	01	01	19
	GND	01	01	01	01	01	01	01	01	01	01	01	01

CANNOT BE MATED TO A METRAL 4000 RECEPTACLE

METRAL P/N	ROW	CONTACT CODE											
		1	2	3	4	5	6	7	8	9	10	11	12
63784-X005 RPU  FOR LEAD FREE SEE NOTE 15	H	05	05	05	05	05	05	01	01	01	01	01	01
	G	05	05	05	05	05	05	01	01	01	01	01	01
	F	05	05	05	05	05	05	01	01	01	01	01	01
	E	05	05	05	05	05	05	01	01	01	01	01	01
	D	01	01	01	01	01	01	01	01	01	01	01	01
	C	01	01	01	01	01	01	01	01	01	01	01	01
	B	01	01	01	01	01	01	01	01	01	01	01	01
	A	01	01	01	01	01	01	01	01	01	01	01	01
	GND	01	01	01	01	01	01	01	01	01	01	01	01

FOR REAR PLUG UP APPLICATIONS, PCB THICKNESS RANGE: 2.95-5.30 WHEN MATED TO METRAL 1000 RECEPT. AND 3.30-5.30 WHEN MATED TO METRAL 4000 RECEPT. (2.30 MIN IN NON-STANDARD REAR PLUG UP APPLICATIONS)

3 |

METRAL P/N	ROW	CONTACT CODE											
		1	2	3	4	5	6	7	8	9	10	11	12
63784-X006 RPU  FOR LEAD FREE SEE NOTE 15	H	05	05	05	05	05	05	05	05	05	05	05	05
	G	05	05	05	05	05	05	05	05	05	05	05	05
	F	05	05	05	05	05	05	05	05	05	05	05	05
	E	05	05	05	05	05	05	05	05	05	05	05	05
	D	19	19	19	19	19	19	19	19	19	19	19	19
	C	01	01	01	01	01	01	01	01	01	01	01	01
	B	01	01	01	01	01	01	01	01	01	01	01	01
	A	01	01	01	01	01	01	01	01	01	01	01	01
	GND	01	01	01	01	01	01	01	01	01	01	01	01

FOR REAR PLUG UP APPLICATIONS, PCB THICKNESS RANGE: 2.95 -5.30 WHEN MATED TO METRAL 1000 RECEPT. AND THIS CONFIGURATION CANNOT BE MATED TO A METRAL 4000 RECEPT. (2.30 MIN IN NON-STANDARD REAR PLUG UP APPLICATIONS)

METRAL P/N	ROW	CONTACT CODE											
		1	2	3	4	5	6	7	8	9	10	11	12
63784-X007  FOR LEAD FREE SEE NOTE 15	H	02	02	02	02	02	02	02	02	02	02	02	02
	G	02	02	02	02	02	02	02	02	02	02	02	02
	F	02	02	02	02	02	02	02	02	02	02	02	02
	E	03	01	02	02	02	02	02	02	02	02	02	02
	D	02	02	02	02	02	02	02	02	02	02	02	03
	C	02	02	02	02	02	02	02	02	02	02	02	02
	B	02	02	02	02	02	02	02	02	02	02	02	02
	A	02	02	02	02	02	02	02	02	02	02	02	02
	GND	02	02	02	02	02	02	02	02	02	02	02	02

METRAL P/N	ROW	CONTACT CODE											
		1	2	3	4	5	6	7	8	9	10	11	12
63784-X008  FOR LEAD FREE SEE NOTE 15	H	02	02	02	02	02	02	02	01	01	01	01	01
	G	02	02	02	02	02	02	02	02	02	02	02	02
	F	02	02	02	02	02	02	02	02	02	02	02	02
	E	02	02	02	02	02	02	02	02	02	02	02	02
	D	02	02	02	02	02	02	02	02	02	02	02	02
	C	02	02	02	02	02	02	02	02	02	02	02	02
	B	02	02	02	02	02	02	02	02	02	02	02	02
	A	02	02	02	02	02	02	02	02	02	02	02	02
	GND	02	02	02	02	02	02	02	02	02	02	02	02

METRAL P/N	ROW	CONTACT CODE											
		1	2	3	4	5	6	7	8	9	10	11	12
63784-X009 RPU  FOR LEAD FREE SEE NOTE 15	H	49	49	49	49	49	49	49	49	49	49	49	49
	G	49	49	49	49	49	49	49	49	49	49	49	49
	F	49	49	49	49	49	49	49	49	49	49	49	49
	E	49	49	49	49	49	49	49	49	49	49	49	49
	D	49	49	49	49	49	49	49	49	49	49	49	49
	C	49	49	49	49	49	49	49	49	49	49	49	49
	B	49	49	49	49	49	49	49	49	49	49	49	49
	A	35	49	49	49	49	49	49	49	49	49	49	49
	GND	36	36	36	36	36	36	36	36	36	36	36	36

FOR REAR PLUG UP APPLICATIONS, PCB THICKNESS RANGE: 4.75 -6.05 WHEN MATED TO METRAL 1000 RECEPT. AND 4.80-6.05 WHEN MATED TO METRAL 4000 RECEPT.

mat'l code SEE NOTE 5				tolerances unless otherwise specified				CUSTOMER		FCI	
ltr	ecn no.	dr	date	linear				COPY		www.fciconnect.com	
AL				0.X ±0.3				projection		title	
				0.XX ±0.13						VERTICAL SIGNAL HDR 8 ROW	
				.XXX ±0.051						P.F. 96 POS. SELECT LOAD EXT.	
				0° ±2°						product family METRAL 1000	
				dr E. KROPER. 2001-01-10				MM		code	
				enrg J. VOLSTORF 2001-01-10				size		213	
				chr J. VOLSTORF 2001-01-10				scale		sheet	
				appd J. VOLSTORF 2001-01-10				1:1		6	
sheet index		revision sheet									

Pro/E

3 |

cage code 22526

4

PDM: Rev:AL

STATUS: Released

Printed: May 13, 2011

This document is the property of and embodies CONFIDENTIAL and PROPRIETARY information of FCi. No part of the information shown on this document may be used in any way or disclosed to others without the written consent of FCi. Copyright FCi.



A

B

METRAL P/N	ROW	CONTACT CODE											
		1	2	3	4	5	6	7	8	9	10	11	12
63784-X010 FOR LEAD FREE SEE NOTE 15	H	02	02	02	02	02	02	02	01	02	02	02	02
	G	02	02	02	02	02	02	02	01	02	02	02	02
	F	02	02	02	02	02	02	02	02	02	02	02	02
	E	02	02	02	02	02	02	02	01	02	02	02	02
	D	02	02	02	02	02	02	02	01	02	02	02	02
	C	02	02	02	02	02	02	02	02	02	02	02	02
	B	02	02	02	02	02	02	02	02	02	02	02	02
	A	02	02	02	02	02	02	02	01	02	02	02	02
	GND	02	02	02	02	02	02	02	02	02	02	02	02

METRAL P/N	ROW	CONTACT CODE											
		1	2	3	4	5	6	7	8	9	10	11	12
63784-X011 FOR LEAD FREE SEE NOTE 15	H	02	03	03	03	03	03	03	03	03	03	03	03
	G	03	03	03	03	03	03	03	03	03	03	03	02
	F	03	03	03	03	03	03	03	03	03	03	03	03
	E	03	03	03	03	03	03	03	03	03	03	03	03
	D	03	03	03	03	03	03	03	03	03	03	03	03
	C	03	03	03	03	03	03	03	03	03	03	03	03
	B	03	03	03	03	03	03	03	03	03	03	03	03
	A	03	03	03	03	03	03	03	03	03	03	03	03
	GND	02	02	02	02	02	02	02	02	02	02	02	02

METRAL P/N	ROW	CONTACT CODE											
		1	2	3	4	5	6	7	8	9	10	11	12
63784-X012 RPU FOR LEAD FREE SEE NOTE 15	H	45	45	45	45	45	45	45	45	45	45	22	22
	G	45	45	45	45	45	45	45	45	45	45	45	45
	F	22	45	45	45	45	45	45	45	45	45	45	45
	E	45	45	45	45	45	45	45	45	45	45	45	45
	D	45	45	45	45	45	45	45	45	45	45	45	45
	C	45	45	45	45	45	45	45	45	45	45	45	45
	B	45	45	45	45	45	45	45	45	45	45	45	45
	A	47	47	47	47	47	47	47	47	47	47	47	47
	GND	22	22	22	22	22	22	22	22	22	22	22	22

METRAL P/N	ROW	CONTACT CODE											
		1	2	3	4	5	6	7	8	9	10	11	12
63784-X013 FOR LEAD FREE SEE NOTE 15	H	02	02	02	02	02	02	02	02	02	02	02	02
	G	02	02	02	02	02	02	02	02	02	02	02	02
	F	02	02	02	02	02	02	02	02	02	02	02	02
	E	03	02	02	02	01	02	02	02	02	02	02	02
	D	02	02	02	02	02	02	02	02	02	02	02	02
	C	02	02	02	02	02	02	02	02	02	02	02	02
	B	02	02	02	02	02	02	02	02	02	02	02	02
	A	02	02	02	02	02	02	02	02	02	02	02	02
	GND	02	02	02	02	02	02	02	02	02	02	02	02

METRAL P/N	ROW	CONTACT CODE											
		1	2	3	4	5	6	7	8	9	10	11	12
63784-X014 FOR LEAD FREE SEE NOTE 15	H	03	03	03	03	03	03	03	03	03	03	03	01
	G	03	03	03	03	03	03	03	03	03	03	03	03
	F	01	03	03	03	03	03	03	03	03	03	03	03
	E	03	03	03	03	03	03	03	03	03	03	03	03
	D	03	03	03	03	03	03	03	03	03	03	03	03
	C	03	03	03	03	03	03	03	03	03	03	03	03
	B	03	03	03	03	03	03	03	03	03	03	03	03
	A	19	19	19	19	19	19	19	19	19	19	19	19
	GND	01	01	01	01	01	01	01	01	01	01	01	01

FOR REAR PLUG UP APPLICATIONS, PCB THICKNESS RANGE: 2.95 -3.80 WHEN MATED TO METRAL 1000 RECEPT. AND THIS CONFIGURATION CANNOT BE MATED TO A METRAL 4000 RECEPT.

CAN NOT BE MATED TO A METRAL 4000 RECEPTACLE

METRAL P/N	ROW	CONTACT CODE											
		1	2	3	4	5	6	7	8	9	10	11	12
63784-X015 FOR LEAD FREE SEE NOTE 15	H	02	02	02	02	02	02	02	02	02	02	02	02
	G	02	02	02	02	02	02	02	02	02	02	02	02
	F	03	03	03	03	03	03	03	03	03	03	03	03
	E	02	02	02	02	02	02	02	02	02	02	02	02
	D	02	02	02	02	02	02	02	02	02	02	02	02
	C	03	03	03	03	03	03	03	03	03	03	03	03
	B	02	02	02	02	02	02	02	02	02	02	02	02
	A	01	02	02	02	02	02	02	02	02	02	02	02
	GND	02	02	02	02	02	02	02	02	02	02	02	02

METRAL P/N	ROW	CONTACT CODE											
		1	2	3	4	5	6	7	8	9	10	11	12
63784-X016 RPU FOR LEAD FREE SEE NOTE 15	H	49	49	49	49	49	49	49	49	49	49	49	49
	G	49	49	49	49	49	49	49	49	49	49	49	49
	F	41	41	41	41	41	41	41	41	41	41	41	41
	E	49	49	49	49	49	49	49	49	49	49	49	49
	D	49	49	49	49	49	49	49	49	49	49	49	49
	C	41	41	41	41	41	41	41	41	41	41	41	41
	B	49	49	49	49	49	49	49	49	49	49	49	49
	A	48	49	49	49	49	49	49	49	49	49	49	49
	GND	49	49	49	49	49	49	49	49	49	49	49	49

METRAL P/N	ROW	CONTACT CODE											
		1	2	3	4	5	6	7	8	9	10	11	12
63784-X017 FOR LEAD FREE SEE NOTE 15	H	02	02	02	02	02	02	02	02	02	02	02	02
	G	04	04	04	04	04	04	04	04	04	02	02	02
	F	02	02	02	02	02	02	02	02	02	02	02	02
	E	02	02	02	02	02	02	02	02	02	02	02	02
	D	04	04	04	04	04	04	04	04	04	02	02	02
	C	02	02	02	02	02	02	02	02	02	02	02	02
	B	02	02	02	02	02	02	02	02	02	02	02	02
	A	04	04	04	04	04	04	04	04	02	02	02	02
	GND	01	01	01	01	01	01	01	01	01	01	01	01

METRAL P/N	ROW	CONTACT CODE											
		1	2	3	4	5	6	7	8	9	10	11	12
63784-X018 FOR LEAD FREE SEE NOTE 15	H	02	02	02	02	02	02	02	02	02	02	02	01
	G	02	02	02	02	02	02	02	02	02	02	02	02
	F	02	02	02	02	02	02	02	02	02	02	02	02
	E	02	02	02	02	02	02	02	02	02	02	02	02
	D	02	02	02	02	02	02	02	02	02	02	02	02
	C	02	02	02	02	02	02	02	02	02	02	02	02
	B	02	02	02	02	02	02	02	02	02	02	02	02
	A	02	02	02	02	02	02	02	02	02	02	02	02
	GND	01	01	01	01	01	01	01	01	01	01	01	01

PCB THICKNESS RANGE FOR REAR PLUG UP APPLICATIONS 5.50 TO 6.80

CAN NOT BE MATED TO A METRAL 4000 RECEPTACLE

A

B

mat'l code SEE NOTE 5				tolerances unless otherwise specified				CUSTOMER		FCi www.fciconnect.com	
ltr	ecn no.	dr	date	linear		0.X ±0.3		COPY		title	
AL				angles		0.XX ±0.13		projection		VERTICAL SIGNAL HDR 8 ROW	
						.XXX ±.051		MM		P.F. 96 POS. SELECT LOAD EXT.	
				dr		0° ±2°		MM		product family METRAL 1000	
				enrg		E. KROPER. 2001-01-10		A		code	
				chr		J. VOLSTORF 2001-01-10		size		213	
				appd		J. VOLSTORF 2001-01-10		dwg no		7	
sheet index	revision sheet							scale		sheet	
								1:1		7	

Pro/E

3

cage code 22526

4

PDM: Rev:AL

STATUS: Released

Printed: May 13, 2011



This document is the property of and embodies CONFIDENTIAL and PROPRIETARY information of FCI. No part of the information shown on this document may be used in any way or disclosed to others without the written consent of FCI. Copyright FCI.

1 | 2

METRAL P/N	ROW	CONTACT CODE											
		1	2	3	4	5	6	7	8	9	10	11	12
63784-X019 RPU FOR LEAD FREE SEE NOTE 15	H	03	03	03	03	03	03	03	03	03	03	03	02
	G	03	03	03	03	03	03	03	03	03	03	03	03
	F	03	03	03	03	03	03	03	03	03	03	03	03
	E	11	11	11	11	11	11	11	11	11	11	11	11
	D	41	41	41	41	41	41	41	41	41	41	41	41
	C	24	24	24	24	24	24	24	24	24	24	24	24
	B	41	41	41	41	41	41	41	41	41	41	41	41
	A	24	24	24	24	24	24	24	24	24	24	24	24
	GND	49	49	49	49	49	49	49	49	49	49	49	49

METRAL P/N	ROW	CONTACT CODE											
		1	2	3	4	5	6	7	8	9	10	11	12
63784-X020 RPU FOR LEAD FREE SEE NOTE 15	H	03	03	03	03	03	03	03	03	03	03	03	03
	G	03	03	03	03	03	03	03	03	03	03	03	03
	F	-	03	-	03	-	03	-	03	-	03	-	03
	E	41	41	41	41	41	41	41	41	41	41	41	41
	D	37	37	37	37	37	37	37	37	37	37	37	37
	C	50	50	50	50	50	50	50	50	50	50	50	50
	B	37	37	37	37	37	37	37	37	37	37	37	37
	A	50	50	50	50	50	50	50	50	50	50	50	50
	GND	06	06	06	06	06	06	06	06	06	06	06	06

A

METRAL P/N	ROW	CONTACT CODE											
		1	2	3	4	5	6	7	8	9	10	11	12
63784-X021 RPU FOR LEAD FREE SEE NOTE 15	H	03	03	03	03	03	03	03	03	03	03	03	02
	G	03	03	03	03	03	03	03	03	03	03	03	03
	F	-	03	-	03	-	03	-	03	-	03	-	03
	E	41	41	41	41	41	41	41	41	03	03	03	03
	D	37	37	37	37	37	37	37	37	03	03	03	03
	C	50	50	50	50	50	50	50	50	03	03	03	03
	B	37	37	37	37	37	37	37	37	03	03	03	03
	A	50	50	50	50	50	50	50	50	03	03	03	03
	GND	06	06	06	06	06	06	06	06	02	02	02	02

METRAL P/N	ROW	CONTACT CODE											
		1	2	3	4	5	6	7	8	9	10	11	12
63784-X022 RPU FOR LEAD FREE SEE NOTE 15	H	03	03	03	03	03	03	03	03	03	03	03	03
	G	03	03	03	03	03	03	03	03	03	03	03	03
	F	-	03	-	03	-	03	-	03	-	03	-	03
	E	41	41	41	41	03	03	03	03	41	41	41	41
	D	37	37	37	37	03	03	03	03	37	37	37	37
	C	50	50	50	50	03	03	03	03	50	50	50	50
	B	37	37	37	37	03	03	03	03	37	37	37	37
	A	50	50	50	50	03	03	03	03	50	50	50	50
	GND	06	06	06	06	02	02	02	02	06	06	06	06

B

METRAL P/N	ROW	CONTACT CODE											
		1	2	3	4	5	6	7	8	9	10	11	12
63784-X023 RPU FOR LEAD FREE SEE NOTE 15	H	03	03	03	03	03	03	03	03	03	03	03	03
	G	03	03	03	03	03	03	03	03	03	03	03	03
	F	-	03	-	03	-	03	-	03	-	03	-	03
	E	03	03	03	03	41	41	41	41	41	41	41	41
	D	03	03	03	03	37	37	37	37	37	37	37	37
	C	03	03	03	03	50	50	50	50	50	50	50	50
	B	03	03	03	03	37	37	37	37	37	37	37	37
	A	03	03	03	03	50	50	50	50	50	50	50	50
	GND	02	02	02	02	06	06	06	06	06	06	06	06

FOR REAR PLUG UP APPLICATIONS, PCB THICKNESS RANGE: 5.70 -7.30 WHEN MATED TO METRAL 1000 RECEPT. AND 6.70-7.30 WHEN MATED TO METRAL 4000 RECEPT. (2.30 MIN IN NON-STANDARD REAR PLUG UP APPLICATIONS)

FOR REAR PLUG UP APPLICATIONS, PCB THICKNESS RANGE: 4.30 -5.70 WHEN MATED TO METRAL 1000 RECEPT. AND 5.30-5.70 WHEN MATED TO METRAL 4000 RECEPT. (2.30 MIN IN NON-STANDARD REAR PLUG UP APPLICATIONS)

FOR REAR PLUG UP APPLICATIONS, PCB THICKNESS RANGE: 4.30 -5.70 WHEN MATED TO METRAL 1000 RECEPT. AND 5.30-5.70 WHEN MATED TO METRAL 4000 RECEPT. (2.30 MIN IN NON-STANDARD REAR PLUG UP APPLICATIONS)

FOR REAR PLUG UP APPLICATIONS, PCB THICKNESS RANGE: 4.30 -5.70 WHEN MATED TO METRAL 1000 RECEPT. AND 5.30-5.70 WHEN MATED TO METRAL 4000 RECEPT. (2.30 MIN IN NON-STANDARD REAR PLUG UP APPLICATIONS)

FOR REAR PLUG UP APPLICATIONS, PCB TH'K RANGE: 4.30-5.70 WHEN MATED TO METRAL 1000 RECEPT. AND 5.30-5.70 WHEN MATED TO METRAL 4000 RECEPT. (2.30 MIN IN NON-STANDARD REAR PLUG-UP APPLICATIONS)

3 |

METRAL P/N	ROW	CONTACT CODE											
		1	2	3	4	5	6	7	8	9	10	11	12
63784-X024 RPU FOR LEAD FREE SEE NOTE 15	H	03	03	03	03	03	03	03	03	03	03	03	03
	G	03	03	03	03	03	03	03	03	03	03	03	03
	F	-	03	-	03	-	03	-	03	-	03	-	03
	E	41	41	41	41	41	41	41	41	03	03	03	03
	D	37	37	37	37	37	37	37	37	03	03	03	03
	C	50	50	50	50	50	50	50	50	03	03	03	03
	B	37	37	37	37	37	37	37	37	03	03	03	03
	A	50	50	50	50	50	50	50	50	03	03	03	03
	GND	06	06	06	06	06	06	06	06	02	02	02	02

METRAL P/N	ROW	CONTACT CODE											
		1	2	3	4	5	6	7	8	9	10	11	12
63784-X025 RPU FOR LEAD FREE SEE NOTE 15	H	03	03	03	03	03	03	03	03	03	03	03	03
	G	03	03	03	03	03	03	03	03	03	03	03	03
	F	-	03	-	03	-	03	-	03	-	03	-	03
	E	03	03	03	03	03	03	03	03	03	03	41	41
	D	03	03	03	03	03	03	03	03	03	03	37	37
	C	03	03	03	03	03	03	03	03	03	03	50	50
	B	03	03	03	03	03	03	03	03	03	03	37	37
	A	03	03	03	03	03	03	03	03	03	03	50	50
	GND	02	02	02	02	02	02	02	02	02	02	06	06

METRAL P/N	ROW	CONTACT CODE											
		1	2	3	4	5	6	7	8	9	10	11	12
63784-X026 RPU FOR LEAD FREE SEE NOTE 15	H	03	03	03	03	03	03	03	03	03	03	03	03
	G	03	03	03	03	03	03	03	03	03	03	03	03
	F	-	03	-	03	-	03	-	03	-	03	-	03
	E	03	03	03	03	03	03	41	41	41	41	41	41
	D	03	03	03	03	03	03	37	37	37	37	37	37
	C	03	03	03	03	03	03	50	50	50	50	50	50
	B	03	03	03	03	03	03	37	37	37	37	37	37
	A	03	03	03	03	03	03	50	50	50	50	50	50
	GND	02	02	02	02	02	02	06	06	06	06	06	06

METRAL P/N	ROW	CONTACT CODE											
		1	2	3	4	5	6	7	8	9	10	11	12
63784-X027 FOR LEAD FREE SEE NOTE 15	H	03	03	03	03	03	03	03	03	03	03	03	03
	G	03	03	03	03	03	03	03	03	03	03	03	03
	F	-	03	-	03	-	03	-	03	-	03	-	03
	E	03	03	03	03	03	03	03	03	03	03	03	03
	D	03	03	03	03	03	03	03	03	03	03	03	03
	C	03	03	03	03	03	03	03	03	03	03	03	03
	B	03	03	03	03	03	03	03	03	03	03	03	03
	A	03	03	03	03	03	03	03	03	03	03	03	03
	GND	02	02	02	02	02	02	02	02	02	02	02	02

FOR REAR PLUG UP APPLICATIONS, PCB THICKNESS RANGE: 4.30 -5.70 WHEN MATED TO METRAL 1000 RECEPT. AND 5.30-5.70 WHEN MATED TO METRAL 4000 RECEPT. (2.30 MIN IN NON-STANDARD REAR PLUG UP APPLICATIONS)

FOR REAR PLUG UP APPLICATIONS, PCB THICKNESS RANGE: 4.30 -5.70 WHEN MATED TO METRAL 1000 RECEPT. AND 5.30-5.70 WHEN MATED TO METRAL 4000 RECEPT. (2.30 MIN IN NON-STANDARD REAR PLUG UP APPLICATIONS)

FOR REAR PLUG UP APPLICATIONS, PCB THICKNESS RANGE: 4.30 -5.70 WHEN MATED TO METRAL 1000 RECEPT. AND 5.30-5.70 WHEN MATED TO METRAL 4000 RECEPT. (2.30 MIN IN NON-STANDARD REAR PLUG UP APPLICATIONS)

mat'l code SEE NOTE 5		tolerances unless otherwise specified		CUSTOMER		FCI www.fciconnect.com		
ltr	ecn no.	dr	date	linear	0.X ±0.3	COPY		
AL				linear	0.XX ±0.13	projection	title	
				angles	.XXX ±.051		VERTICAL SIGNAL HDR 8 ROW	
					0° ±2°		P.F. 96 POS. SELECT LOAD EXT.	
				dr	E. KROPER. 2001-01-10		product family	
				engr	J. VOLSTORF 2001-01-10		METRAL 1000	code
				chr	J. VOLSTORF 2001-01-10		size	213
				appd	J. VOLSTORF 2001-01-10		dwg no	8
sheet index	revision sheet					scale	8	
						1:1	sheet	
							8	

Pro/E

3 |

cage code 22526

4



This document is the property of and embodies CONFIDENTIAL and PROPRIETARY information of FCi. No part of the information shown on this document may be used in any way or disclosed to others without the written consent of FCi. Copyright FCi.



A

B

METRAL P/N	ROW	CONTACT CODE											
		1	2	3	4	5	6	7	8	9	10	11	12
63784-X028 RPU FOR LEAD FREE SEE NOTE 15	H	05	05	05	05	05	05	05	05	05	05	05	05
	G	05	05	05	05	05	05	05	05	05	05	05	05
	F	05	05	05	05	05	05	05	05	05	05	05	05
	E	05	05	05	05	05	05	05	05	05	05	05	05
	D	01	01	01	01	01	01	01	01	01	01	01	01
	C	01	01	01	01	01	01	01	01	01	01	01	01
	B	01	01	01	01	01	01	01	01	01	01	01	01
	A	01	01	01	01	01	01	01	01	01	01	01	01
GND	01	01	01	01	01	01	01	01	01	01	01	01	

FOR REAR PLUG UP APPLICATIONS, PCB THICKNESS RANGE: 2.95 -5.30 WHEN MATED TO METRAL 1000 RECEPT. AND 3.30-5.30 WHEN MATED TO METRAL 4000 RECEPT. (2.30 MIN IN NON-STANDARD REAR PLUG UP APPLICATIONS) NO PIN ALIGNER

METRAL P/N	ROW	CONTACT CODE											
		1	2	3	4	5	6	7	8	9	10	11	12
63784-X029 RPU FOR LEAD FREE SEE NOTE 15	H	01	01	01	01	01	01	01	01	01	01	01	01
	G	01	01	01	01	01	01	01	01	01	01	01	01
	F	01	01	01	01	01	01	01	01	01	01	01	01
	E	05	05	05	05	05	05	05	05	05	05	05	05
	D	05	05	05	05	05	05	05	05	05	05	05	05
	C	05	05	05	05	05	05	05	05	05	05	05	05
	B	05	05	05	05	05	05	05	05	05	05	05	05
	A	05	05	05	05	05	05	05	05	05	05	05	05
GND	01	01	01	01	01	01	01	01	01	01	01	01	

FOR REAR PLUG UP APPLICATIONS, PCB THICKNESS RANGE: 2.95 -5.30 WHEN MATED TO METRAL 1000 RECEPT. AND 3.30-5.30 WHEN MATED TO METRAL 4000 RECEPT. (2.30 MIN IN NON-STANDARD REAR PLUG UP APPLICATIONS) NO PIN ALIGNER

METRAL P/N	ROW	CONTACT CODE											
		1	2	3	4	5	6	7	8	9	10	11	12
63784-X030 RPU FOR LEAD FREE SEE NOTE 15	H	05	05	05	05	05	05	01	01	01	01	01	01
	G	05	05	05	05	05	05	01	01	01	01	01	01
	F	05	05	05	05	05	05	01	01	01	01	01	01
	E	05	05	05	05	05	05	01	01	01	01	01	01
	D	01	01	01	01	01	01	01	01	01	01	01	01
	C	01	01	01	01	01	01	01	01	01	01	01	01
	B	01	01	01	01	01	01	01	01	01	01	01	01
	A	01	01	01	01	01	01	01	01	01	01	01	01
GND	01	01	01	01	01	01	01	01	01	01	01	01	

FOR REAR PLUG UP APPLICATIONS, PCB THICKNESS RANGE: 2.95 -5.30 WHEN MATED TO METRAL 1000 RECEPT. AND 3.30-5.30 WHEN MATED TO METRAL 4000 RECEPT. (2.30 MIN IN NON-STANDARD REAR PLUG UP APPLICATIONS) NO PIN ALIGNER

METRAL P/N	ROW	CONTACT CODE											
		1	2	3	4	5	6	7	8	9	10	11	12
63784-X031 RPU FOR LEAD FREE SEE NOTE 15	H	05	05	05	05	05	05	05	05	05	05	05	05
	G	05	05	05	05	05	05	05	05	05	05	05	05
	F	05	05	05	05	05	05	05	05	05	05	05	05
	E	05	05	05	05	05	05	05	05	05	05	05	05
	D	19	19	19	19	19	19	19	19	19	19	19	19
	C	01	01	01	01	01	01	01	01	01	01	01	01
	B	01	01	01	01	01	01	01	01	01	01	01	01
	A	01	01	01	01	01	01	01	01	01	01	01	01
GND	01	01	01	01	01	01	01	01	01	01	01	01	

FOR REAR PLUG UP APPLICATIONS, PCB THICKNESS RANGE: 2.95 -5.30 WHEN MATED TO METRAL 1000 RECEPT. AND 3.30-5.30 WHEN MATED TO METRAL 4000 RECEPT. (2.30 MIN IN NON-STANDARD REAR PLUG UP APPLICATIONS) NO PIN ALIGNER

METRAL P/N	ROW	CONTACT CODE											
		1	2	3	4	5	6	7	8	9	10	11	12
63784-X032 RPU FOR LEAD FREE SEE NOTE 15	H	03	03	03	03	03	03	03	03	03	03	19	02
	G	03	03	03	03	03	03	03	03	03	03	19	19
	F	-	03	-	03	-	03	-	03	-	03	-	03
	E	41	41	41	41	41	41	41	03	03	19	19	19
	D	37	37	37	37	37	37	37	37	19	19	03	03
	C	50	50	50	50	50	50	50	50	03	03	19	19
	B	37	37	37	37	37	37	37	37	03	03	19	19
	A	50	50	50	50	50	50	50	03	03	19	19	19
GND	06	06	06	06	06	06	06	06	02	02	02	02	

FOR REAR PLUG UP APPLICATIONS, PCB THICKNESS RANGE: 4.30-5.70 WHEN MATED TO METRAL 1000 RECEPT. CANNOT BE MATED TO METRAL 4000 RECEPT. (2.30 MIN IN NON-STANDARD REAR PLUG-UP APPLICATIONS)

mat'l code SEE NOTE 5				tolerances unless otherwise specified		CUSTOMER		FCi		www.fciconnect.com	
ltr	ecn no.	dr	date	linear	0.X ±0.3	COPY		title			
AL				linear	0.XX ±0.13	projection		VERTICAL SIGNAL HDR 8 ROW			
				angles	.XXX ±.051			P.F. 96 POS. SELECT LOAD EXT.			
				dr	E. KROPER. 2001-01-10	MM		product family		METRAL 1000	code
				engr	J. VOLSTORF 2001-01-10			size		dwg no	213
				chr	J. VOLSTORF 2001-01-10	scale		A		63784	sheet
				appd	J. VOLSTORF 2001-01-10	1:1					9
sheet index	revision sheet										

METRAL P/N	ROW	CONTACT CODE											
		1	2	3	4	5	6	7	8	9	10	11	12
63784-X033 *RPU FOR LEAD FREE SEE NOTE 15	H	03	03	03	03	03	03	03	03	03	03	03	03
	G	03	03	03	03	03	03	03	03	03	03	03	03
	F	-	03	-	03	-	03	-	03	-	03	-	03
	E	03	03	41	41	41	41	41	03	03	03	03	03
	D	03	03	37	37	37	37	37	37	03	03	03	03
	C	03	03	50	50	50	50	50	50	03	03	03	03
	B	03	03	37	37	37	37	37	37	03	03	03	03
	A	03	03	50	50	50	50	50	50	03	03	03	03
GND	02	02	06	06	06	06	06	06	02	02	02	02	

FOR REAR PLUG UP APPLICATIONS, PCB THICKNESS RANGE: 4.30 -5.70 WHEN MATED TO METRAL 1000 RECEPT. AND 5.30-5.70 WHEN MATED TO METRAL 4000 RECEPT. (2.30 MIN IN NON-STANDARD REAR PLUG UP APPLICATIONS)

METRAL P/N	ROW	CONTACT CODE											
		1	2	3	4	5	6	7	8	9	10	11	12
63784-X034 FOR LEAD FREE SEE NOTE 15	H	02	02	02	02	02	02	02	02	02	02	02	02
	G	02	02	02	02	02	02	02	02	02	02	02	02
	F	04	04	02	02	02	02	02	02	02	02	02	02
	E	02	02	02	02	02	02	02	02	02	02	02	02
	D	02	02	02	02	02	02	02	02	02	02	02	02
	C	02	02	02	02	02	02	02	02	02	02	02	02
	B	02	02	02	02	02	02	02	02	02	02	02	02
	A	02	02	02	02	02	02	02	02	02	02	02	02
GND	02	02	02	02	02	02	02	02	02	02	02	02	

METRAL P/N	ROW	CONTACT CODE											
		1	2	3	4	5	6	7	8	9	10	11	12
63784-X035 FOR LEAD FREE SEE NOTE 15	H	02	02	02	02	02	02	02	02	02	02	02	02
	G	02	02	02	02	02	02	02	02	02	02	02	02
	F	04	04	02	02	02	02	02	01	02	02	02	02
	E	02	02	02	02	02	02	02	02	02	02	02	02
	D	02	02	02	02	02	02	02	02	02	02	02	02
	C	02	02	02	02	02	02	02	02	02	02	02	02
	B	02	02	02	02	02	02	02	02	02	02	02	02
	A	02	02	02	02	02	02	02	02	02	02	02	02
GND	02	02	02	02	02	02	02	02	02	02	02	02	

METRAL P/N	ROW	CONTACT CODE											
		1	2	3	4	5	6	7	8	9	10	11	12
63784-X036 FOR LEAD FREE SEE NOTE 15	H	02	02	02	02	02	02	03	01	01	03	01	01
	G	02	02	02	02	02	02	03	01	01	03	01	01
	F	02	02	02	02	02	02	03	01	01	03	01	01
	E	03	02	02	02	02	02	03	01	01	03	01	01
	D	03	02	02	02	02	02	03	01	01	03	01	01
	C	03	02	02	02	02	02	03	01	01	03	01	01
	B	03	02	03	02	02	02	03	01	01	03	01	01
	A	03	02	02	02	02	02	02	01	01	03	01	01
GND	02	02	02	02	02	02	02	02	02	02	02	02	

A

B

Pro/E

3

cage code 22526

4

PDM: Rev:AL

STATUS: Released

Printed: May 13, 2011

METRAL P/N	ROW	CONTACT CODE											
		1	2	3	4	5	6	7	8	9	10	11	12
63784-X037 FOR LEAD FREE SEE NOTE 15	H	03	02	02	03	02	03	02	02	02	02	03	02
	G	03	02	02	03	02	03	02	03	03	02	03	02
	F	03	02	02	03	03	03	03	02	02	03	03	02
	E	03	02	02	03	02	03	02	03	02	02	03	02
	D	03	02	02	03	02	03	02	03	02	02	03	03
	C	03	02	02	03	03	03	03	03	02	03	03	02
	B	03	02	02	03	02	03	02	02	02	02	03	02
	A	03	02	02	03	02	03	02	02	02	02	03	02
	GND	02	02	02	02	02	02	02	02	02	02	02	02

METRAL P/N	ROW	CONTACT CODE											
		1	2	3	4	5	6	7	8	9	10	11	12
63784-X042 FOR LEAD FREE SEE NOTE 15	H	01	02	02	02	02	02	01	02	02	02	02	03
	G	02	02	02	02	02	02	02	02	02	02	02	03
	F	02	02	02	02	02	02	02	02	02	02	02	03
	E	02	02	02	02	02	02	02	02	02	02	02	03
	D	02	02	02	02	02	02	02	02	02	02	02	03
	C	02	02	02	02	02	02	02	02	02	02	02	03
	B	02	02	02	02	02	02	02	02	02	02	03	03
	A	02	02	02	02	02	02	02	02	02	02	02	03
	GND	01	01	01	01	01	01	01	01	01	01	01	01



METRAL P/N	ROW	CONTACT CODE											
		1	2	3	4	5	6	7	8	9	10	11	12
63784-X038 FOR LEAD FREE SEE NOTE 15	H	02	02	02	19	-	19	-	02	-	02	-	19
	G	02	02	02	19	-	19	-	02	-	02	-	19
	F	02	-	02	19	-	19	-	-	-	02	-	19
	E	02	02	02	19	-	19	-	02	-	02	-	19
	D	02	02	02	19	-	19	-	02	-	02	-	19
	C	02	02	02	19	-	19	-	02	-	02	-	19
	B	02	02	02	19	-	19	-	02	-	02	-	19
	A	02	02	02	19	-	19	-	02	-	02	-	19
	GND	-	-	-	-	-	-	-	-	-	-	-	-

METRAL P/N	ROW	CONTACT CODE											
		1	2	3	4	5	6	7	8	9	10	11	12
63784-X043 FOR LEAD FREE SEE NOTE 15	H	02	02	02	02	01	02	01	02	02	02	02	03
	G	02	02	02	02	01	02	02	02	02	02	02	03
	F	02	02	02	02	01	02	02	02	02	02	02	03
	E	02	02	02	02	01	02	02	02	02	02	02	03
	D	02	02	02	02	03	02	02	02	02	02	02	03
	C	02	02	02	02	03	02	02	02	02	02	02	03
	B	02	02	02	02	03	02	02	02	02	02	02	03
	A	02	02	02	02	03	02	02	02	02	02	02	03
	GND	01	01	01	01	01	01	01	01	01	01	01	01

METRAL P/N	ROW	CONTACT CODE											
		1	2	3	4	5	6	7	8	9	10	11	12
63784-X039 FOR LEAD FREE SEE NOTE 15	H	02	02	02	02	02	02	02	02	02	03	03	03
	G	02	02	02	02	02	02	02	02	03	03	03	03
	F	02	02	02	03	02	02	02	02	03	03	03	03
	E	02	02	02	01	02	02	02	02	03	03	03	03
	D	03	01	02	01	02	02	02	02	03	03	03	03
	C	02	02	02	01	02	02	02	02	03	03	03	03
	B	02	02	02	01	02	02	02	02	03	03	03	03
	A	03	01	02	01	02	02	02	02	03	03	03	03
	GND	01	01	01	01	01	01	01	01	01	01	01	01

METRAL P/N	ROW	CONTACT CODE											
		1	2	3	4	5	6	7	8	9	10	11	12
63784-X040 FOR LEAD FREE SEE NOTE 15	H	03	03	03	03	03	03	02	02	02	02	02	02
	G	03	03	03	03	03	03	02	02	02	02	02	02
	F	03	03	03	03	03	03	02	02	02	02	02	02
	E	03	03	03	03	03	03	02	02	02	02	02	02
	D	03	03	03	03	03	03	02	02	02	02	02	02
	C	03	03	03	03	03	03	02	02	02	02	02	02
	B	03	03	03	03	03	03	02	02	02	02	02	02
	A	03	03	03	03	03	03	02	02	02	02	02	02
	GND	01	01	01	01	01	01	01	01	01	01	01	01

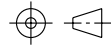
METRAL P/N	ROW	CONTACT CODE											
		1	2	3	4	5	6	7	8	9	10	11	12
63784-X041 FOR LEAD FREE SEE NOTE 15	H	02	02	02	02	02	02	02	02	02	02	01	02
	G	02	02	02	02	02	02	02	02	02	02	01	02
	F	02	02	02	02	02	02	02	02	02	02	02	01
	E	02	02	02	02	02	02	02	02	02	02	02	02
	D	02	02	02	02	02	02	02	02	02	02	03	02
	C	02	02	02	02	02	02	02	02	02	02	03	02
	B	02	02	02	02	02	02	02	02	02	02	03	02
	A	02	02	02	02	02	02	02	02	02	02	01	02
	GND	01	01	01	01	01	01	01	01	01	01	01	01

mat'l code SEE NOTE 5				tolerances unless otherwise specified				CUSTOMER		 www.fciconnect.com	
ltr	ecr no.	dr	date	linear	0.X ±0.3				COPY		title VERTICAL SIGNAL HDR 8 ROW P.F. 96 POS. SELECT LOAD EXT.
AL					0.XX ±0.13				projection		
					.XXX ±.051						
				angles	0° ±2°						product family METRAL 1000 code size dwg no A 63784 sheet 10
					dr	E. KROPER.	2001-01-10	MM		scale 1:1	
					enrg	J. VOLSTORF	2001-01-10				
					chr	J. VOLSTORF	2001-01-10				
				appd	J. VOLSTORF	2001-01-10					
sheet index	revision sheet										

This document is the property of and embodies  
 CONFIDENTIAL and PROPRIETARY information of FCI.  
 No part of the information shown on this  
 document may be used in any way or disclosed  
 to others without the written consent of FCI.  
 Copyright FCI.