

8 7 6 5 4 3 2 1

NOTES:

1. MOUNTING: Panel mounting hole .171" (4.34mm) Diameter
 Litepipe from .200" to .500" use grommet retainer RTN 150
 Litepipe from .500" to 2.00" the spring retainer RTN 250 is recommended for rigidity
2. Standoff used to adjust the height of a standard LED above the PCB to maintain a maximum .050" clearance between Litepipe and LED.
3. U.S. & Foreign Pat Issued & Pend.

REVISIONS				
ECN #	REV	DESCRIPTION	DATE	INITIALS
	N/A	INITIAL RELEASE	8/25/98	JS
	1	UPDATE DWG FORMAT	12/15/08	JG
	2	REVISE .170" DIMENSION TOLERANCES	3/11/09	AZ
	001	REVISED PER ECR111009AZ01	4/23/10	KH

**RETAINERS
(ORDER SEPARATELY)**

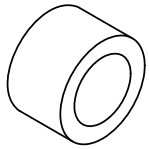

RTN 150

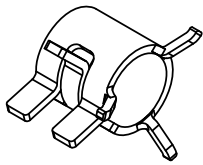

RTN 250

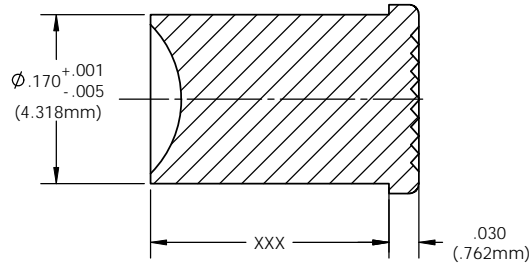
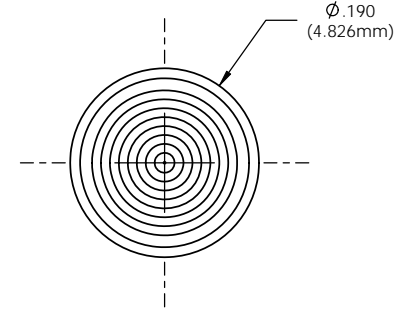
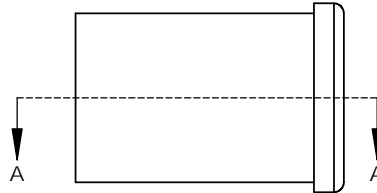
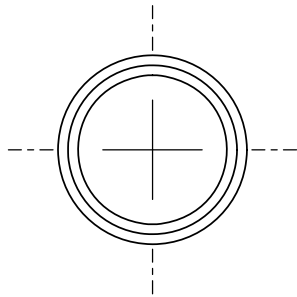

SECTION A-A



ORDERING CODE: **LPC XXX CTP**

**LENGTH CODE
(Min 020=.200" / Max 200=2.000")**

020	038	056	074	092	112	135	157	180
022	040	058	076	094	115	137	160	182
024	042	060	078	096	117	140	162	185
026	044	062	080	098	120	142	165	187
028	046	064	082	100	122	145	167	190
030	048	066	084	102	125	147	170	192
032	050	068	086	105	127	150	172	195
034	052	070	088	107	130	152	175	197
036	054	072	090	110	132	155	177	200

COLOR	
CTP	CLEAR

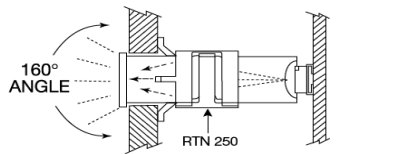

SPECIAL LENGTHS UPON REQUESTS

<small>UNLESS OTHERWISE SPECIFIED DIMENSIONS ARE IN INCHES</small> ANGLES DECIMALS ±1° .X ±.020 FINISH .XXX ±.010 .XXX ±.005 <small>BREAK ALL CORNERS AND SHARP EDGES (R1/16")</small>  THIRD ANGLE PROJECTION <small>THE INFORMATION CONTAINED IN THIS DRAWING IS THE SOLE PROPERTY OF VISUAL COMMUNICATIONS COMPANY, INC. AND IS REPRODUCED IN PART OR AS A WHOLE WITHOUT THE WRITTEN CONSENT OF VISUAL COMMUNICATIONS COMPANY, INC. IS PROHIBITED.</small>	MATERIAL ACRYLIC (OPTICAL GRADE) UL 94-HB	VISUAL COMMUNICATIONS COMPANY, INC. 190 Bossick Boulevard, Suite 101 San Marcos, CA 92069 USA Phone (760) 560-1300 Fax (760) 560-1301 email vccsales@vccite.com
	FINISH SEE NOTES	TITLE: CLIPLITE 4MM LITEPIPE VERTICAL
APPROVAL DRAWN K.Howard CHECKED DPZ	DATE 4/23/10 5/4/10	SIZE DWG. NO. B LPC XXX CTP SCALE: 8:1
DO NOT SCALE DRAWING	REV 001 SHEET 1 OF 1	

8 7 6 5 4 3 2 1