

# FSR® 400 Series Data Sheet

## Features and Benefits

- Actuation Force as low as 0.2N and sensitivity range to 20N
- Cost Effective
- Ultra Thin
- Robust; up to 10M actuations
- Simple and easy to integrate

## Description

Interlink Electronics FSR® 400 series is part of the single zone Force Sensing Resistor® family. Force Sensing Resistors®, or FSRs, are robust polymer thick film (PTF) devices that exhibit a decrease in resistance with increase in force applied to the surface of the sensor. This force sensitivity is optimized for use in human touch control of electronic devices such as automotive electronics, medical systems, industrial, and robotics applications.

The 400 series sensors come in six different models with four different connecting options.

## Force Sensing Resistors®



**FSR® 400 Short**  
5mm Circle X 20mm



**FSR® 400**  
5mm Circle X 38mm



**FSR® 402 Short**  
13mm Circle X 25mm



**FSR® 402**  
13mm Circle X 56mm

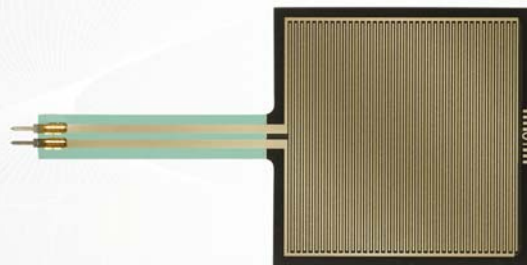

**FSR® 406**  
38mm Square X 83mm

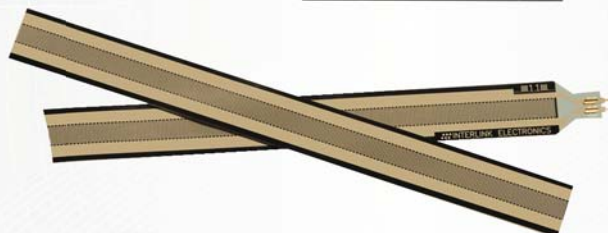

**FSR® 408**  
10mm X 622mm Strip



P/N: 94-00027 Rev. D

## Applications

### Detect & qualify press

Sense whether a touch is accidental or intended by reading force

### Use force for UI feedback

Detect more or less user force to make a more intuitive interface

### Enhance tool safety

Differentiate a grip from a touch as a safety lock

### Find centroid of force

Use multiple sensors to determine centroid of force

### Detect presence, position, or motion

of a person or patient in a bed chair, or medical device

Many other force change detection applications

## Device Characteristics

Actuation Force*	~0.2N min
Force Sensitivity Range*	~0.2N - 20N
Force Resolution	Continuous (analog)
Force Repeatability Single Part	+/- 2%
Force Repeatability Part to Part	+/- 6% (Single Batch)
Non-Actuated Resistance	>10 Mohms
Hysteresis	+10% Average $(R_{F+} - R_{F-})/R_{F+}$
Device Rise Time	< 3 microseconds
Long Term Drift 1kg load, 35 days	< 5% $\log_{10}(\text{time})$
Operating Temperature Performance	
Cold: -40°C after 1 hour	-5% average resistance change
Hot: +85°C after 1 hour	-15% average resistance change
Hot Humid: +85°C 95RH after 1 hour	+10% average resistance change
Storage Temperature Performance	
Cold: -25°C after 120 hours	-10% average resistance change
Hot: +85°C after 120 hours	-5% average resistance change
Hot Humid: +85°C 95RH after 240 hours	+30% average resistance change
Tap Durability Tested to 10 Million actuations, 1kg, 4Hz	-10% average resistance change
Standing Load Durability 2.5kg for 24 hours	-5% average resistance change
EMI	Generates No EMI
ESD	Not ESD sensitive
UL	All materials UL grade 94 V-1 or better
RoHS	Compliant

Specifications are derived from measurements taken at 1000 grams, and are given as (one standard deviation / mean), unless otherwise noted.

\*Typical value. Force dependent on actuation interface, mechanics, and measurement electronics

## Connector Options

Bare Tail



Female Tin Contacts  
PN: TE 2-487406-4

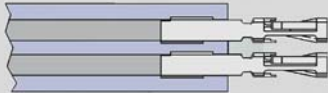

Female Tin Contacts  
with 2 Pin Housing  
PN: TE 2-487406-4  
PN: TE 487378-1



Solder Tabs  
PN: TE 1-88997-2

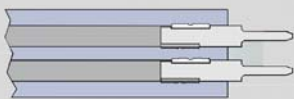

**Other Available Part Numbers:**  
Hardware Development Kit  
PN: 54-76247

## Application Information

Force Sensing Resistors®

For specific application needs please contact Interlink Electronics support team. An integration guide and Hardware Development Kit (HDK) are also available.

FSRs® are two-wire devices with a resistance that depends on applied force. To the right is a force vs. resistance graph that illustrates a typical FSR® response characteristic. Please note that the graph values are reference only and actual values are dependent upon actuation system mechanics and sensor geometry.

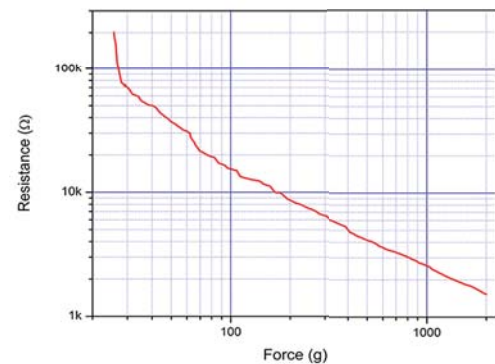

For a simple force-to-voltage conversion, the FSR® device is tied to a measuring resistor in a voltage divider (see figure below) and the output is described by the following equation.

$$V_{OUT} = \frac{R_M V^+}{(R_M + R_{FSR})}$$

In the shown configuration, the output voltage increases with increasing force. If  $R_{FSR}$  and  $R_M$  are swapped, the output swing will decrease with increasing force.

The measuring resistor,  $R_M$ , is chosen to maximize the desired force sensitivity range and to limit current. Depending on the impedance requirements of the measuring circuit, the voltage divider could be followed by an op-amp.

A family of force vs.  $V_{OUT}$  curves is shown on the graph below for a standard FSR in a voltage divider configuration with various  $R_M$  resistors. A  $V^+$  of +5V was used for these examples. Please note that the graph values are for reference only and will vary between different sensors and applications.

Refer to the FSR® integration guide for more integration methods and techniques.

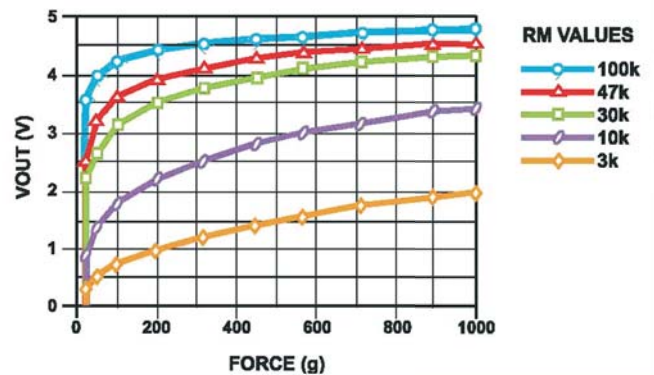
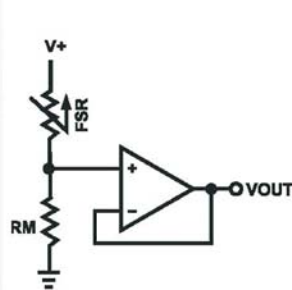

# FSR® Model 400 Short Tail

Force Sensing Resistors®

## Model 400 Short Tail:

Active Area:  $\varnothing 5.62\text{mm}$

Normal Thickness: 0.30mm

Switch Travel: 0.05mm

## Available Part Numbers:

PN: 34-47021 Model 400 Short Tail  
- No contacts or solder tabs

PN: 34-00005 Model 400 Short Tail  
- with female contacts

PN: 34-00006 Model 400 Short Tail  
- with female contacts and Housing

PN: 34-00004 Model 400 Short Tail  
- with solder tabs

## Sensor Mechanical Data

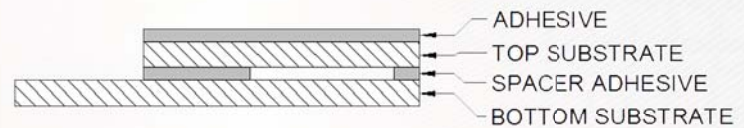
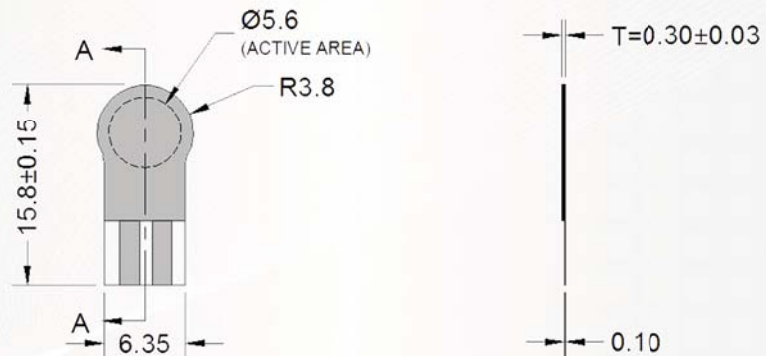

SECTION A-A  
LAYER STACK-UP

## Exploded View

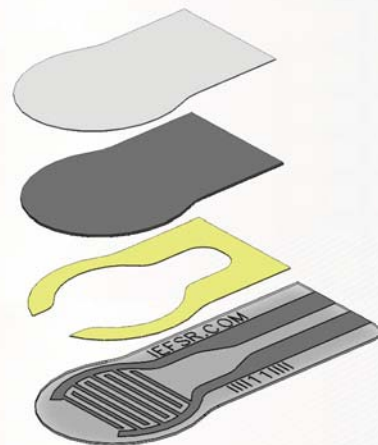

Sensor mechanical 3D CAD data can be found on our website at [www.interlinkelectronics.com/Support](http://www.interlinkelectronics.com/Support)

# FSR® Model 400

Force Sensing Resistors®

## Model 400:

Active Area:  $\varnothing 5.08\text{mm}$   
Nominal Thickness: 0.30mm  
Switch Travel: 0.05mm

## Available Part Numbers:

- PN: 34-00007 Model 400  
- no contacts or solder tabs
- PN: 34-00011 Model 400  
- with female contacts
- PN: 34-44001 Model 400  
- with female contacts and housing
- PN: 30-49649 Model 400  
- with solder tabs

## Sensor Mechanical Data

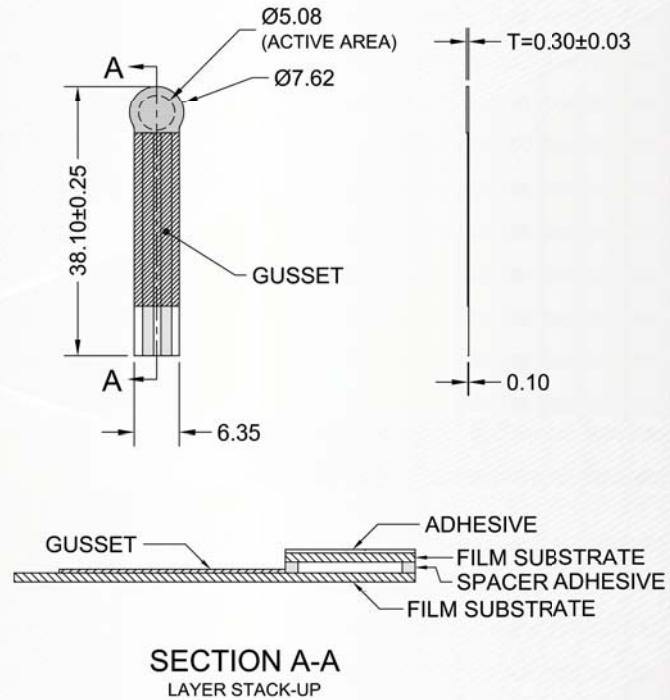

## Exploded View

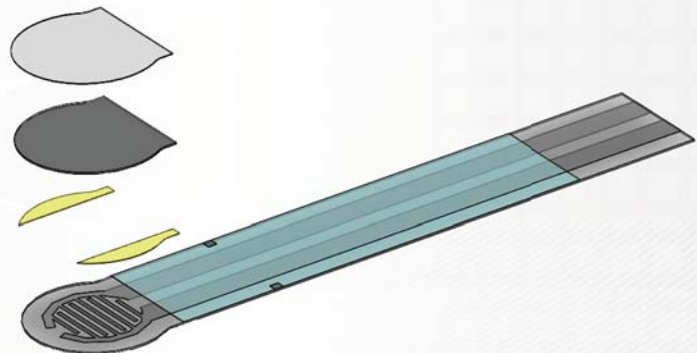

Sensor mechanical 3D CAD data can be found on our website at [www.interlinkelectronics.com/Support](http://www.interlinkelectronics.com/Support)

# FSR® Model 402

Force Sensing Resistors®

## Model 402:

Active Area:  $\varnothing$  14.68mm

Nominal Thickness: 0.46mm

Switch Travel: 0.15mm

## Available Part Numbers:

PN: 44-29103 Model 402  
- no contacts or solder tabs

PN: 34-00012 Model 402  
- with female contacts

PN: 34-00001 Model 402  
- with female contacts and housing

PN: 30-81794 Model 402  
- with solder tabs

## Sensor Mechanical Data

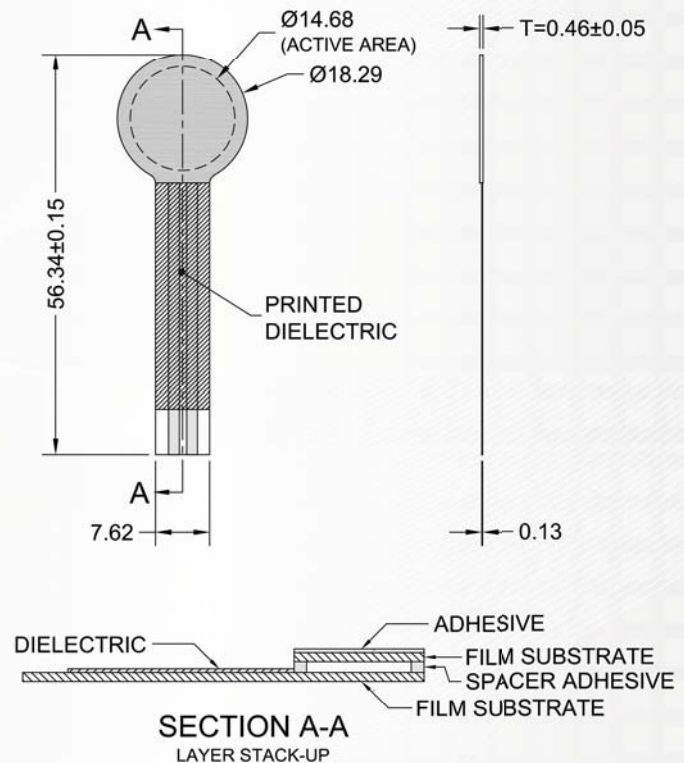

## Exploded View

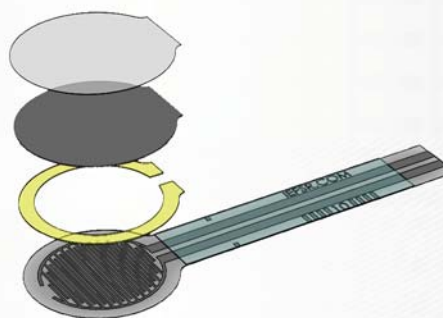

Sensor mechanical 3D CAD data can be found on our website at [www.interlinkelectronics.com/Support](http://www.interlinkelectronics.com/Support)

# FSR® Model 402 Short Tail

Force Sensing Resistors®

## Model 402 Short Tail:

Active Area:  $\varnothing 12.70\text{mm}$

Nominal Thickness: 0.46mm

Switch Travel: 0.15mm

## Available Part Numbers:

PN: 34-00016 Model 402 Short Tail  
- no contacts or solder tabs

PN: 34-00017 Model 402 Short Tail  
- with female contacts

PN: 34-00018 Model 402 Short Tail  
- with female contacts and housing

PN: 34-00015 Model 402 Short Tail  
- with solder tabs

## Sensor Mechanical Data

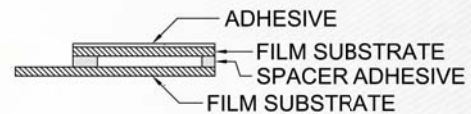
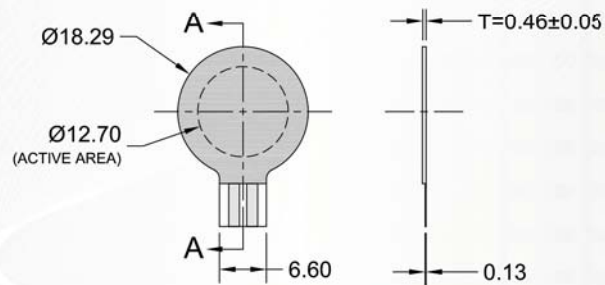

SECTION A-A  
LAYER STACK-UP

## Exploded View

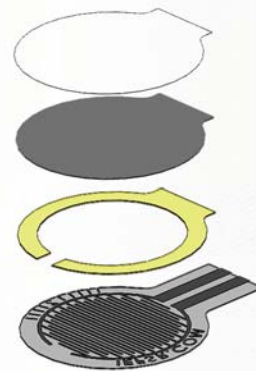

Sensor mechanical 3D CAD data can be found on our website at [www.interlinkelectronics.com/Support](http://www.interlinkelectronics.com/Support)

# FSR® Model 406

## Model 406:

Active Area: 39.6mm x 39.6mm

Nominal Thickness: 0.46mm

Switch Travel: 0.15mm

## Available Part Numbers:

PN: 34-00009 Model 406  
- no contacts or solder tabs

PN: 34-00013 Model 406  
- with female contacts

PN: 34-61152 Model 406  
- with female contacts and housing

PN: 30-73258 Model 406  
- with solder tabs

Force Sensing Resistors®

## Sensor Mechanical Data

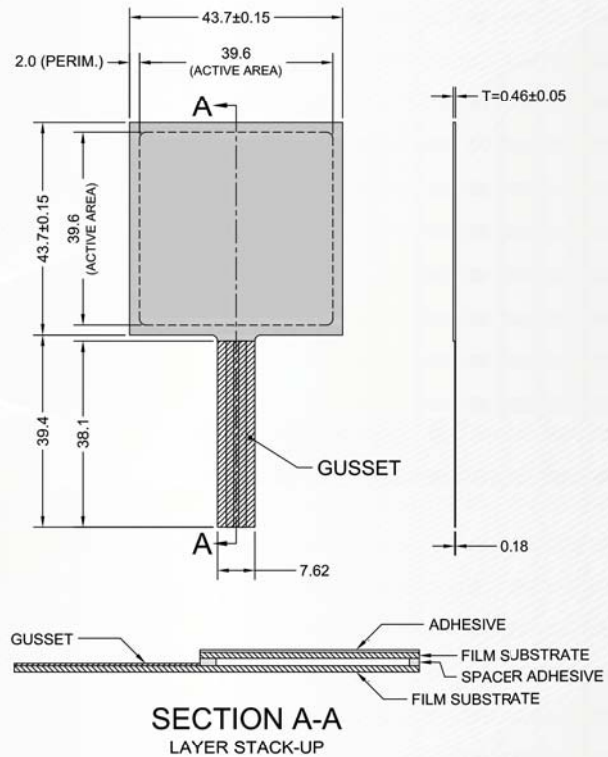

## Exploded View

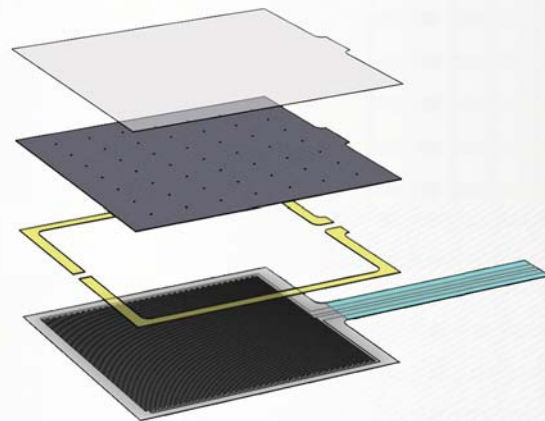

Sensor mechanical 3D CAD data can be found on our website at [www.interlinkelectronics.com/Support](http://www.interlinkelectronics.com/Support)



# FSR® Model 408

## Model 408:

Active Area: 609.6mm x 10.2mm

Nominal Thickness: 0.41mm

Switch Travel: 0.15mm

## Available Part Numbers:

PN: 34-00010 Model 408  
- no contacts or solder tabs

PN: 34-75319 Model 408  
- with female contacts

PN: 34-23845 Model 408  
- with female contacts and housing

PN: 30-61710 Model 408  
- with solder tabs

Force Sensing Resistors®

## Sensor Mechanical Data

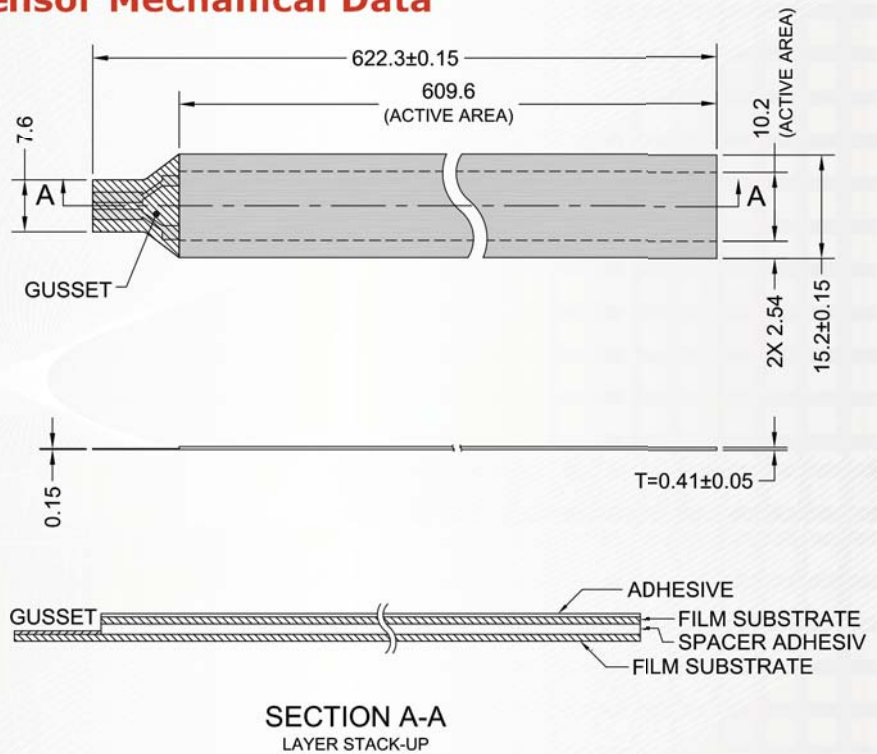

## Exploded View

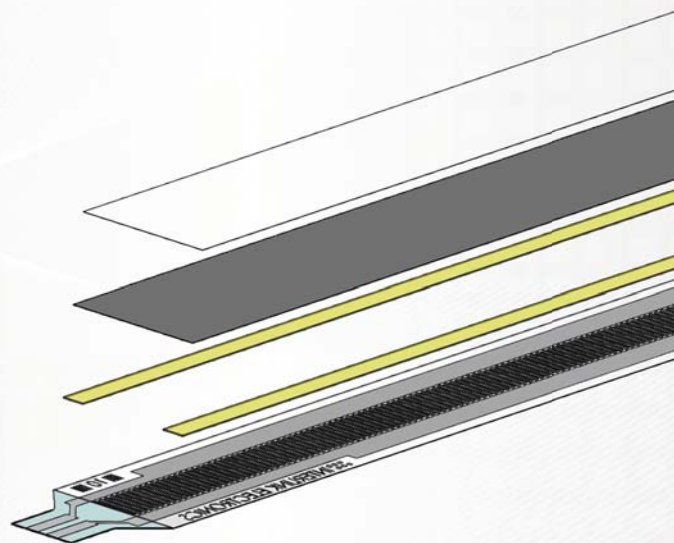

## Contact Us

### United States Corporate Office

Interlink Electronics, Inc.  
546 Flynn Road  
Camarillo, CA 93012, USA  
Phone: +1-805-484-8855  
Fax: +1-805-484-9457  
www.interlinkelectronics.com  
Sales and support:  
sales@interlinkelectronics.com

### Japan

Japan Sales Office  
Phone: +81-45-263-6500  
Fax: +81-45-263-6501  
www.interlinkelec.co.jp

Sensor mechanical 3D CAD data can be found on our website at  
[www.interlinkelectronics.com/Support](http://www.interlinkelectronics.com/Support)